

A2000

Multifunctional Power Meter

3-348-981-03

27/2.15



1	Application	4
2	Instrument Description	4
2.1	Instrument Overview	4
2.2	Inputs, Outputs and Interfaces	5
2.3	Available Measurement Data	8
2.4	Possible A2000 Parameter Settings	10
2.5	Factory Default Instrument Parameters	12
3	Operating the A2000	13
3.1	Control Panel	13
3.2	Response After Auxiliary Power is Switched On	13
3.3	Menu Display for Measurements in 4-Wire Systems	14
3.4	Menu Display for Measurements in 3-Wire Systems	16
3.5	Error Messages	18
4	Configuring the A2000	19
4.1	Configuring the Limit Value Relays	20
4.2	Adjustment of Display Brightness and Filter	22
4.3	Measurement Inputs, Configuring the Synchronizing Input	24
4.4	Messeingänge, Analogeingänge konfigurieren (Feature A3) (nicht bei LON und Profibus-DP)	26
4.5	Configuring the Analog Outputs (not with Profibus-DP)	28
4.6	Configuring the S0 Pulse Outputs	29
4.7	Data Logger Display and Configuration	30
4.8	Configuring the Energy Meter Mode/Low Tariff	35
4.9	Interface Configuration	36
4.10	Uploading and Deleting Parameters, Setting the Clock	38
5	Electrical Connections and Circuits	40
6	Interface Description	44
6.1	General	45
6.2	Communications Protocol	45

Contents	Page
7 Dimensional Drawing	46
8 Technical Data	47
9 Maintenance – Device Return and Environmentally Sound Disposal	50
10 Repair and Replacement Parts Service Calibration Center and Rental Instrument Service	51
11 Product Support Industrial Division	51

1 Application

The A2000 measuring instrument is used for the analysis and monitoring of 3-phase current systems. It can be operated with internal transformers in 3-phase current systems of up to 5 A and 500 V nominal voltage, and can perform measurements in medium-voltage systems in combination with external current and voltage transformers.

The A2000 acquires voltages, current, frequency and phase displacement in 3 and 4-wire systems. It calculates active, reactive and apparent power, active and reactive energy, as well as the power factor for the individual phases based upon these values.

An FFT (= Fast Fourier Transformation) is performed on the basis of the currents and phase voltages and the harmonic waves are determined up to the 15th harmonic. For the phase voltages, the harmonic distortions of the individual harmonics are indicated as well as the total harmonic distortion, for the currents, the respective RMS values are indicated.

Transformation ratios can be entered to the instrument, which means that all primary measurement data can be displayed directly at the A2000. Maximum values are stored to memory for every measured or calculated quantity. If limit values are exceeded, corrective action can be triggered via relay outputs. Energy meters, recorders, data loggers and control loops can be connected to the digital and analog outputs. Via the analog outputs 2 random measured quantities can be acquired by means of standard signal generator or temperatures via Pt1000 sensor. The instrument can be integrated into a field bus system or a LON network with the communications interfaces, or its parameters can be configured with a PC.

2 Instrument Description

2.1 Instrument Overview

Inputs

- 3 ea. Voltage Inputs
- 3 ea. Current Inputs
- 1 ea. Synchronizing Input
- Analog Inputs
In1, In2 (optional)

Communication Interfaces

A2000

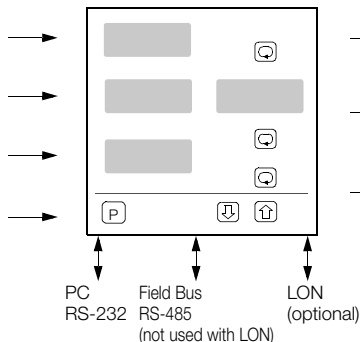

Outputs

- 2 ea. Limit Value Relays
Relay 1, Relay 2
- 2 ea. Pulse Outputs (optional)
S01, S02
S0 Standard
- 4 ea. Analog Outputs
A1, A2 (A3, A4 optional)

2.2 Inputs, Outputs and Interfaces

Current Inputs

All current inputs are isolated from one another. If measurements are performed with external transformers, their primary and secondary current values must be entered, in order to enable direct display of current values. Switching between the two meas. ranges (1 A and 5 A) is accomplished via software.

Connection with 3 current transformers in 3/4-wire systems (4L)

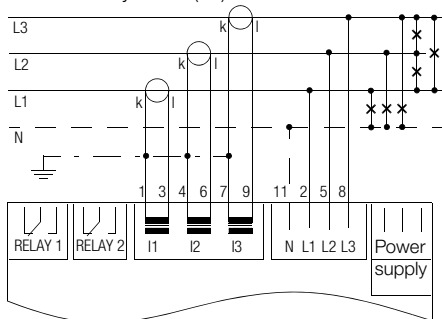

Connection with 2 current transformers in 3-wire systems (3L)

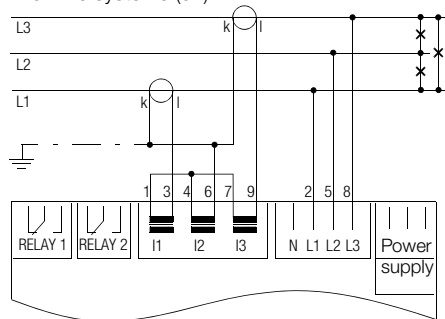

Connection with 1 current transformer in 4-wire systems (balanced load) (3L-1)

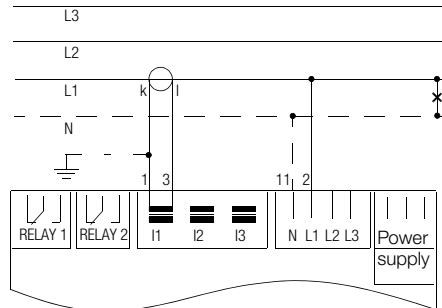

Connection with 1 current transformer in 3-wire systems (balanced load) (3L-1)

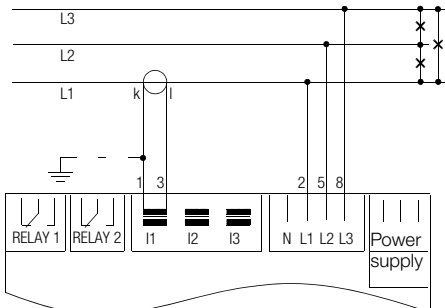

Connection with 1 current transformer
in 3-wire systems (balanced load) (3L13)

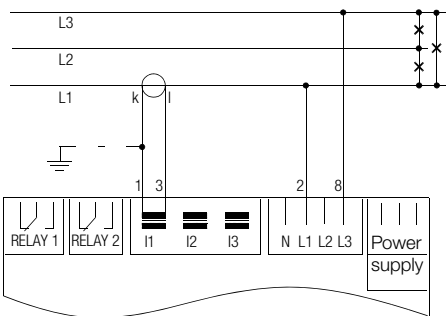

For this connection type the accuracy values for the measurement of power, energy and power factor are only observed in the case of low-distortion tension. The setting „Compensating reactive power“ is not possible.

Connection with 3 current transformers
in 4-wire systems (Open Y) (4L13)

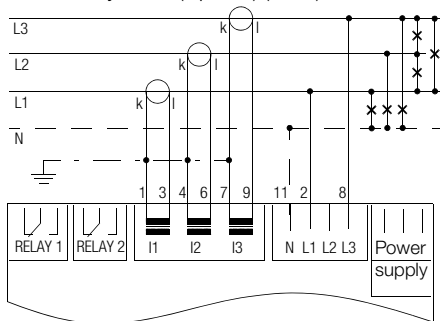

Voltage Inputs

Each voltage measurement input is provided with a safety impedance (incl. the N conductor). Measurements within 3-phase systems of up to 500 V are possible without the use of external transformers.

Mains Supply Power

Mains supply power must correspond to the specified values indicated on the serial plate. Correct connection is absolutely essential!

Synchronizing Input

The synchronizing input is used to select the interval for calculation of the consumption value. An external, potential-free contact must be used to drive this input. However, synchronization can also be internally controlled with the software. Alternatively, a switch-over between low tariff and high tariff is possible with the synchronizing input (see chapter 4.8 on page 35).

Relay Outputs

Limit values can be monitored for every measured or calculated quantity. These limit values can be assigned to the relay outputs.

Pulse Outputs

The values for measured reactive and active energy can be read out at the pulse outputs in the form of standard S0 pulses for the driving of electromechanical counting mechanisms.

Analog Outputs

Each measured or calculated quantity can be assigned to one of the analog outputs. Exception: FFT-values, which can only be read out via the RS-232 and RS-488 interfaces.

This allows for the logging or driving of secondary control loops. The outputs can be configured as voltage or current outputs with the help of the DIP switches.

Analog Inputs

The 2 inputs can be configured separately via DIP switch for 10 V, 20 mA or Pt1000 signal. Adjusting the possible signal input ranges as well as scaling and evaluation of measured values and the associated maximum values can be done via the operating panel and the RS232 and RS485 interfaces.

Communications Interfaces

The A2000 is provided with RS232 and RS485 interfaces as standard equipment. The RS485 interface is not included with the LON model due to space limitations.

The **RS232 interface** allows for the transmission of measurement values from the A2000 to a PC, as well as external instrument configuration. The chapter entitled "Interface Description" on page 44 provides detailed information regarding the generation of user specific programs. The **RS485** field bus interface allows for the interconnection of up to 32 instruments.

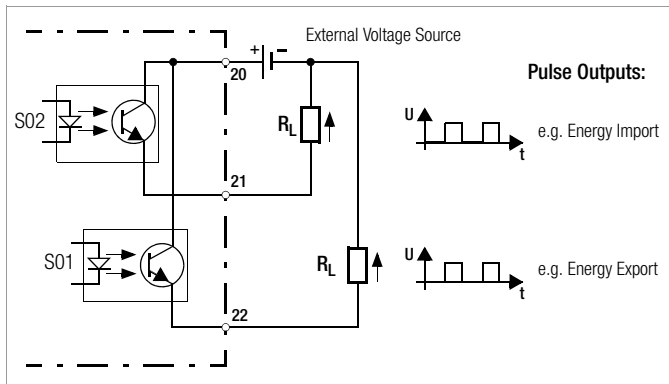

2.3 Available Measurement Data

	Individual Phases				Collective Values				
Phase Voltages	U1 ... U3		U1 _{max} ... U3 _{max}		U _Σ ⁴⁾		U _{Σ max} ⁵⁾		
Delta Voltages	U12, U23, U31		U12 _{max} ... U31 _{max}		U _{Δavg} ⁴⁾		U _{Δavg max} ⁵⁾		
Phase Current	I1 ... I3		I1 _{max} ... I3 _{max}		I _Σ ⁴⁾		I _{Σ max} ⁵⁾		
Averaged Phase Current	I1 _{avg} ... I3 _{avg}		I1 _{avg max} ... I3 _{avg max}		I _{avg} ⁴⁾		I _{avg max} ⁵⁾		
Neutral Conductor current	In		In _{max}		—		—		
Averaged Neutral Conductor Current	In _{avg}		In _{avg max}		—		—		
Line Frequency	—		—		f		—		
Active Power	P1 ... P3		P1 _{max} ... P3 _{max}		P _Σ		P _{Σ max}		
Reactive Power	Q1 ... Q3		Q1 _{max} ... Q3 _{max}		Q _Σ		Q _{Σ max}		
Apparent Power	S1 ... S3		S1 _{max} ... S3 _{max}		S _Σ		S _{Σ max}		
Power Factors	PF1 ... PF3		PF1 _{min} ... PF3 _{min}		PF _Σ		PF _{Σ min}		
Energy Mode	L123 ¹⁾	L1HT ²⁾	L123 ¹⁾	L1HT ²⁾	L123 ¹⁾	L1HT ²⁾		L123 ¹⁾	L1HT ²⁾
Active Energy	E _{P1} ... E _{P3}	—	—	—	E _{PΣ}	E _{PΣ L-} , E _{PΣ L+} ³⁾ E _{PΣ H-} , E _{PΣ H+}		—	—
Reactive Energy	E _{Q1} ... E _{Q3}	—	—	—	E _{QΣ}	E _{QΣ L-} , E _{QΣ L+} ³⁾ E _{QΣ H-} , E _{QΣ H+}		—	—
Intervalic Active Energy	—		—		P _{int Σ}		P _{int Σ max}		
Interv. Reactive Energy	—		—		Q _{int Σ}		Q _{int Σ max}		
Interv. Apparent Energy	—		—		S _{int Σ}		S _{int Σ max}		
THD, 1 st ... 15 th harmon.	U1h ... U3h, I1h ... I3h		U1h _{max} ... U3h _{max} , I1h _{max} ... I3h _{max}		—		—		
In1, In2	Measured Value 1, 2 ⁶⁾		Max. Meas. Value 1, 2 ⁶⁾		—		—		

1) L123 = individual phases L1, L2, L3

2) L1HT = low tariff (LT) high tariff (HT)

3) L = low tariff, H = high tariff, + = import, - = export

4) only via interface and as a source for relay and analog output

5) only via interface

6) Value range depends on configuration

- The determination of measured and calculated quantities is performed in accordance with DIN 40110 part 1,2 4.96 (non-sinusoidal quantities).
- PEN conductor current is not taken into consideration for the calculation of collective phase current and collective apparent power.
- The averaging of currents I1_{avg} ... I3_{avg}, In_{avg} is performed in the same manner as with a bimetallic indicator, with a setting time of approx. 10 min relative to 99% of the final value.

Display of Reactive Power

$d_i n$ = calculation of reactive power per
DIN 40110 without + or - sign

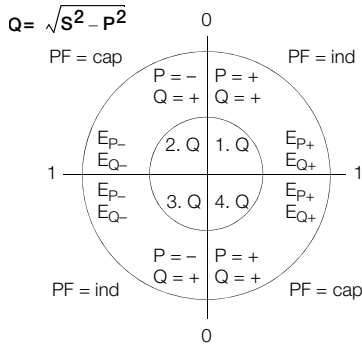

$S_i \bar{U}_n$ = calculation of reactive power with + or -

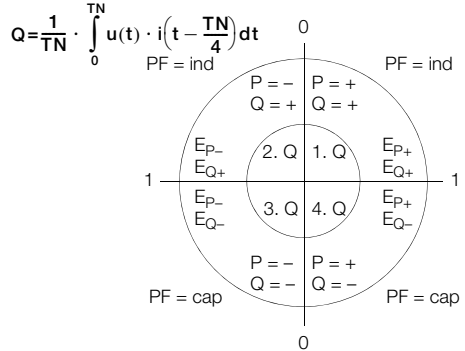

$\bar{U}_n \bar{I}_P$ = compensating reactive power
(reactive power is only produced if current
and voltage have different + or - signs)

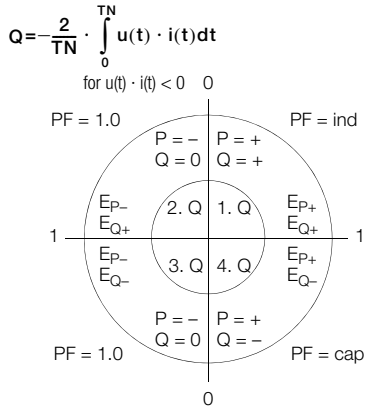

Calculation of Collective Values

$$U_{\Delta \text{avg}} = (U_{12} + U_{23} + U_{31}) / 3$$

$$U_{\Sigma} = \sqrt{U_1^2 + U_2^2 + U_3^2}$$

$$I_{\Sigma} = \sqrt{I_1^2 + I_2^2 + I_3^2} \text{ (without } I_N)$$

$$S_{\Sigma} = U_{\Sigma} \cdot I_{\Sigma}$$

$$P_{\Sigma} = P_1 + P_2 + P_3$$

$$Q_{\Sigma} = \sqrt{S_{\Sigma}^2 - P_{\Sigma}^2} \text{ (per DIN)}$$

$$Q_{\Sigma} = Q_1 + Q_2 + Q_3 \text{ (others)}$$

$$PF_{\Sigma} = P_{\Sigma} / S_{\Sigma}$$

2.4 Possible A2000 Parameter Settings

Inputs 4 or 3-Wire Connection	Primary Transformer Phase Conductor	Secondary Trans- former Phase Conduc- tor	Transformer Primary Current	Transformer Secondary Current	Synchronization Pulse
	100 V ... 800 kV	100 V ... 500 V	1 A ... 150 kA	1 A, 5 A	external or internal: 1 ... 60 minutes
Relay 1, 2 Max, Min	Source 1) 4)	Limit Value 2)	Hysteresis 0 ... 9999 Digit	Delay 0 ... 30 min	Alarm Memory off, on
Analog Outputs 1 ... 4	Source 1) 3)	Output 0 ... 20 mA 4 ... 20 mA -20 ... +20 mA -10 ... +10 mA	Start Source 2)	End Source 2)	
Analog Inputs In1, In2	Source	Range of Source	Scale Range		Position of Decimal Point
	Standard Signal	0 ... 20 mA/0 ... 10 V 4 ... 20 mA/2 ... 10 V -20...+20 mA/0...10 V -10...+10 mA/-5...+5 V	Lower Limit -1999 ... +9999	Upper Limit -1999 ... +9999	1999 199.9 19.99 1.999
	Pt1000	185.6 ... 3933 Ω	-200 °C / -328 °F -199.9 °C/°F	860 °C / 1580 °F 859.9 °C / 999.9 °F	199 199.9
	Offset		-100 °C/°F	+100 °C/°F	99 / 99.9
Pulse Outputs S01, S02	Source	Energy Type	Energy Direction	Pulse Rate	Tariff
	L1, L2, L3, Σ	Active, Reactive Energy	Import, Export	1... 5000 pulses/kWh (MWh) 1... 5000 pulses/kArh (MVarh)	High, low tariff
Display	Brightness 0 ... 7	Filter 0 ... 30 s			
Interfaces RS-232, RS-485	Address	Baud Rate	Parity	Protocol	
	0 ... 254	1200, 2400, 4800, 9600, 19200	Even, odd, space, no	E244, 870, Mod1, Mod2	
Energy Meter	Mode		Switch-over high/low tariff		
	L123 / LTHT ⁵⁾		Clock / Synchr. input		
Reactive Power	per DIN / with +/- sign / for Compensation				

1) Possible sources (see below)

2) Limits are dependent upon the selected transformation ratio at the voltage or current transformer

3) Interval -1 applies to P_{int} , Q_{int} or S_{int} (for recording max. values)

4) Interval 0 applies to P_{int} , Q_{int} or S_{int} (current shutdown interval for shutdown options)

5) L123 = individual phases L1, L2, L3; LTHT = low tariff high tariff

Possible Parameter Setting, Data Logger

Trigger: relay 1, Relay 2, both, off	Pretrigger: 0%, 25%, 50%, 75%	Disable Trigger: External (Synchronizing Input), off
Sampling Time: 0,3 s, 0,6 s, 1 s, 2 s, 5 s, 10 s, 15 s, 30 s, 1 min, 2 min, 5 min, 10 min, 15 min, 30 min	Storetime: 1 min, 2 min, 5 min, 10 min, 15 min, 30 min, 1 h, 2 h, 4 h, 8 h, 12 h, 1 day, 2 day, 4 day	Storemode: cyclic, once
Trace 1 ... 12: Source, off		

Possible Sources for Relays, Analog Outputs and Logger

	U Δ	U ∇	I	I _{avg}	P	Q	S	PF	Fre- quency	P _{int}	Q _{int}	S _{int}	Ext
Source	U12	U1	I1	I1 _{avg}	P1	Q1	S1	PF1	f	P _{intΣ}	Q _{intΣ}	S _{intΣ}	Actu- tion via inter- face (not for logger)
	U23	U2	I2	I2 _{avg}	P2	Q2	S2	PF2					
	U31	U3	I3	I3 _{avg}	P3	Q3	S3	PF3					
	U Δ _{mean}	U Σ	I Σ	I Σ _{avg}	P Σ	Q Σ	S Σ	PF Σ					
	—	—	I _n	I _n _{avg}	—	—	—	—					
for all Phases (only for Relays)													

Additional Sources for Logger

	EP	EQ	I hd	U hd
Source	EP1 / EP Σ _{L-}	EQ1 / EQ Σ _{L-}	I thd	U thd
	EP2 / EP Σ _{L+}	EQ2 / EQ Σ _{L+}	I 1.hd	U 1.hd
	EP3 / EP Σ _{H-}	EQ3 / EQ Σ _{H-}	:	:
	EP Σ / EP Σ _{H+}	EQ Σ / EQ Σ _{H+}	I 15.hd	U 15.hd

2.5 Factory Default Instrument Parameters

Inputs	Primary Transformer Phase Conductor	Secondary Transformer Phase Conductor	Transformer Primary Current	Transformer Secondary Current	Synchronization Pulse
4-Wire	500 V	500 V	5 A	5 A	Internal, 15 minutes
Relay 1	Source	Limit Value	Contact Type	Hysteresis, Delay	Alarm Memory
	I1	5 A	Max	0	off
Relay 2	U1	240 V	Max	0	off
	Source	Output	Start Source	End Source	
Analog Output 1	PΣ	4 ... 20 mA	0 W	2000 W	
Analog Output 2	QΣ	4 ... 20 mA	0 VAr	1000 VAr	
Analog Output 3	I2	4 ... 20 mA	0 A	5 A	
Analog Output 4	U2	4 ... 20 mA	0 V	250 V	
Analog Inputs	Source	Range of Source	Scale Range		Position of DecimalPoint
			Lower Limit	Upper Limit	
In1	±24 mA	4 ... 20 mA	0	5000	1999,
In2	±24 mA	4 ... 20 mA	0	2500	1999,
	Source	Energy Type	Energy Direction	Pulse Rate	Tariff
S01	EPΣ	Active Energy	Import	10 pulses/kWh	High tariff
S02	EPΣ	Active Energy	Export	10 pulses/kWh	High tariff
Display	Brightness 5	Filter 0			
RS-232, RS-485	Baud Rate 9600	Address 250	Parity Even	Protocol E244	
Energy Meter	Mode LTHT				
Reactive Power	per DIN				

Factory Default Data Logger Parameters

Trigger: off	Pretrigger: 50%	disable Trigger: off
Sampling time: 0.3 s	Storetime: 1 min	Storemode: once
Trace 1 ... 12: all off		

This table applies to the setting: “Set – set default”.

3 Operating the A2000

3.1 Control Panel

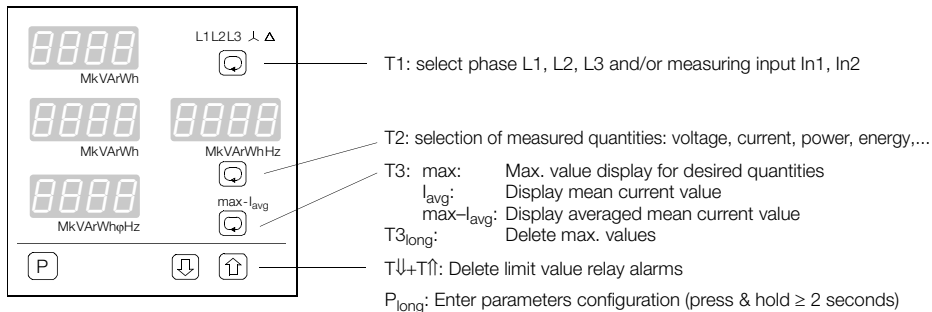

3.2 Response After Auxiliary Power is Switched On

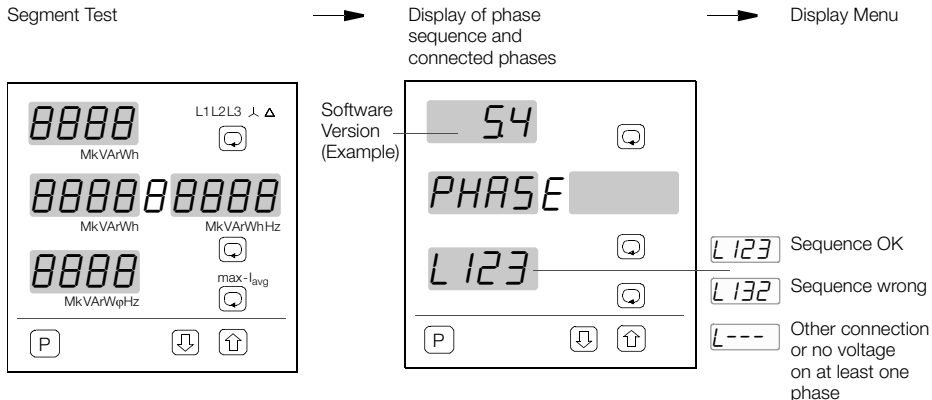

The operating mode displayed prior to shutdown is displayed when the instrument is switched on again.

3.3 Menu Display for Measurements in 4-Wire Systems

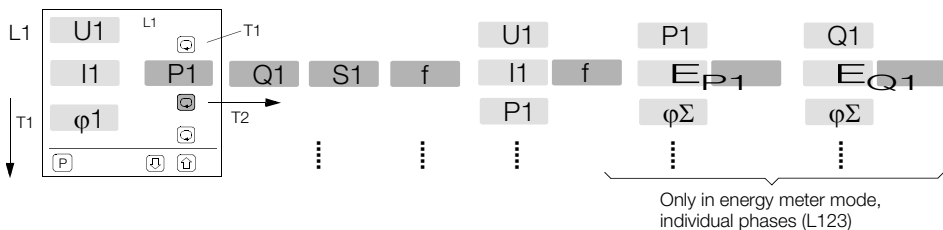

L2 See diagram L1 for L2 values

L3 See diagram L1 for L3 values

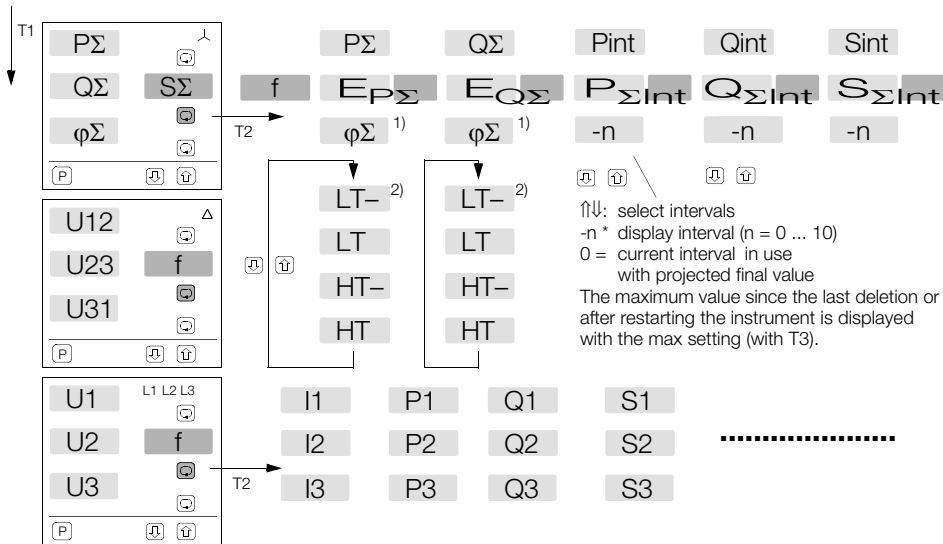

continued from page 14 bottom

for Feature A3 only (Analog Input)

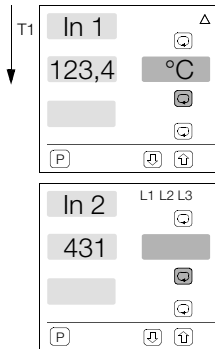

Example: Temperature
123.4 °C

Example: Standard Input

If a rotating field is established at the U or I inputs of the A2000, the neutral conductor current is displayed instead of the frequency.

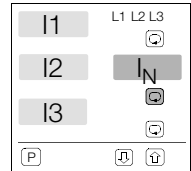

L1, L2, L3, λ , Δ , L123, In1 and In2 comprise 8 display groups. If a given group is exited, the current display mode is stored to memory and is re-initialized when the group is queried again.

- 1) in energy meter mode L123
- 2) in energy meter mode LTHT

- LT-** Low Tariff Export
- LT** Low Tariff Import
- HT-** High Tariff Export
- HT** High Tariff Import

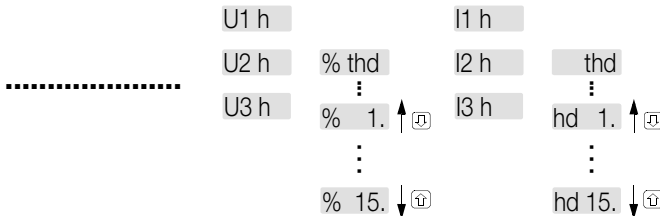

When displaying the maximum values of the harmonic, press key [P] to indicate the time and date when the respective maximum value occurred. (Function only available for version with data logger)

3.4 Menu Display for Measurements in 3-Wire Systems

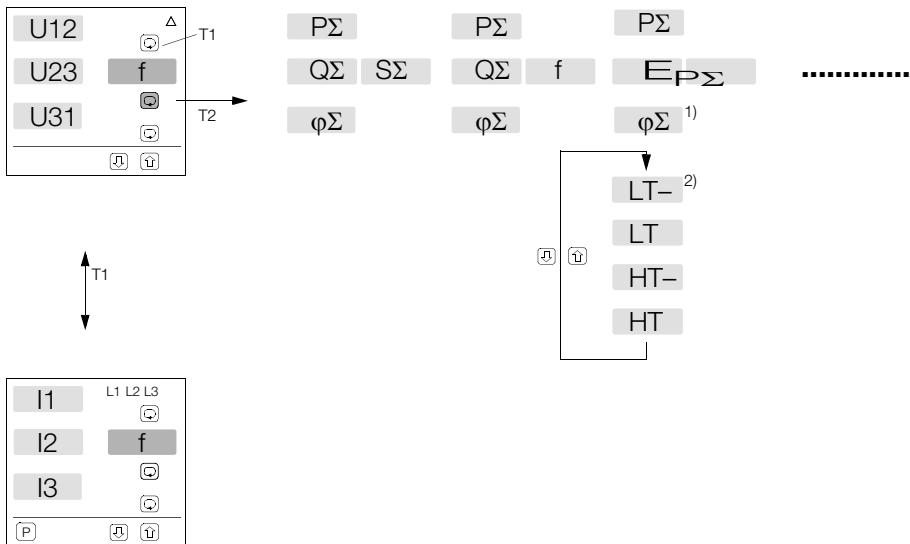

If a rotating field is established at the U or I inputs of the A2000, the neutral conductor current is displayed instead of the frequency.

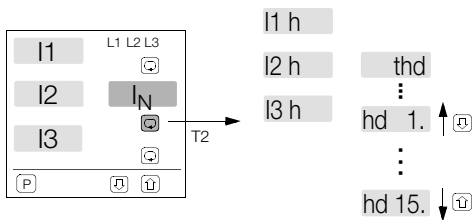

When displaying the maximum values of the harmonic, press key [P] to indicate the time and date when the respective maximum value occurred. (Function only available for version with data logger)

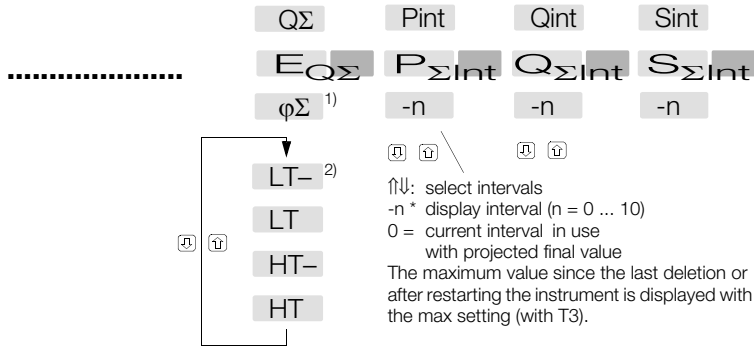

1) in energy meter mode L123

2) in energy meter mode LHHT

$LT-$ Low Tariff Export

LT Low Tariff Import

$HT-$ High Tariff Export

HT High Tariff Import

3.5 Error Messages



Parameters Error

One or more parameters have been irretrievably corrupted or are beyond the setting range. Remedy: Enter [P]_{long} configurations menu.

- SET USER restores the user parameter set which has been stored to memory.
- SET DEFAULT restores all factory default parameters.

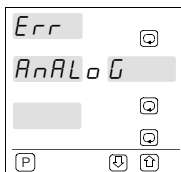

Error at Analog Component

Check the measuring voltages with a multimeter in the direct current measuring range to see whether or not they demonstrate a direct current component of greater than 6 V.

If this is not the case, the analog component is defective. Send the instrument to our service department.

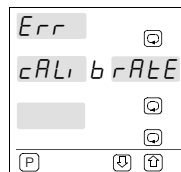

Calibration Error

The calibration values of the A2000 are beyond the setting range or are not compatible with each other.

Send the instrument to our service department.

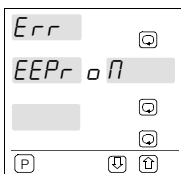

EEPROM Error

See Parameters Error

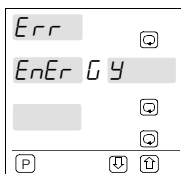

Energy Meter Error

The meter reading can only be set to zero. Remedy: Enter [P]_{long} configurations menu
→ SET ENERGY 0

4 Configuring the A2000

Configuration changes are only possible if the 'LOCK' DIP switch is in the 'off' position.

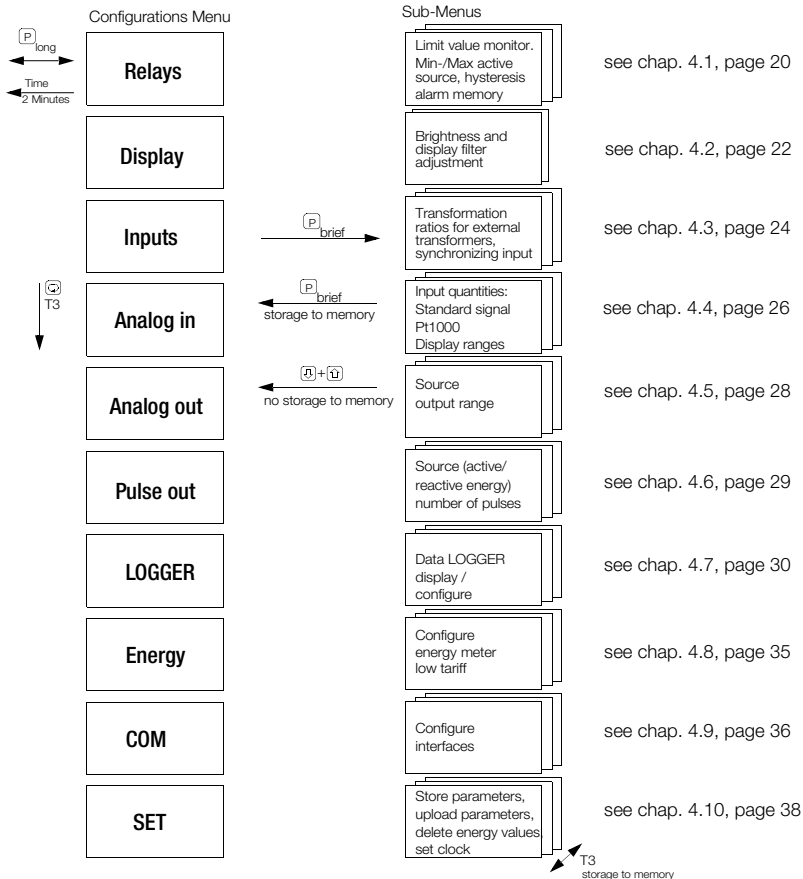

4.1 Configuring the Limit Value Relays

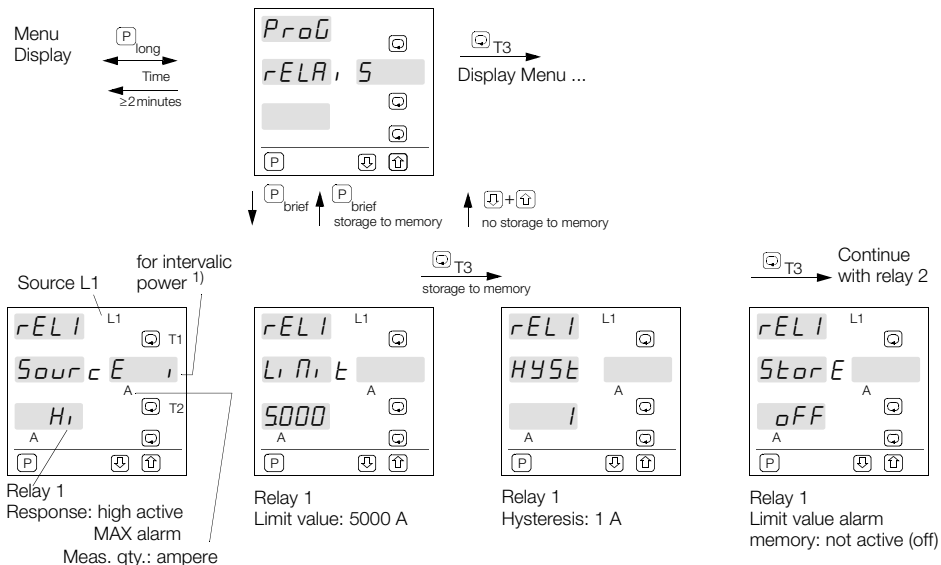

T1: Source Selection

L1, L2, L3 Individual Phases

L12, L23, L13 Phase-to-phase voltage

Collective Values

L123 Neutral Conductor Current

L123_ for all Phases

T2: Meas. Quantity Selection

V_{Δ} , V , A, A_{AVG} , W,

VAr, VA, ϕ , Hz, Wi,

VAr, VAr, external

T T : Value Settings

Limit values: high / low active

T T : Value Settings

Hz: 40.00 ... 70.00

V, A: 1 ... 9999 2)

W, ... -9999 ... 9999 2)

PF: 0.01c ... 0.99c ...

... 1.00 ...

0.99L ... 0.01L

T T : Value Settings

0, 1, ... 9999 Digits

T T : Value Settings

Alarm memory

on = active

off = not active

In the display mode,
a stored alarm is
(simultaneously) deleted
with T T .

¹⁾ The source is relative to the current (-0) interval value ($P_{\Sigma \text{int}}$, $Q_{\Sigma \text{int}}$, $S_{\Sigma \text{int}}$) for intervalic power

²⁾ Decimal point depending upon settings of the transformation ratio

Example: Limit value relay 2, but with other quantities and values.

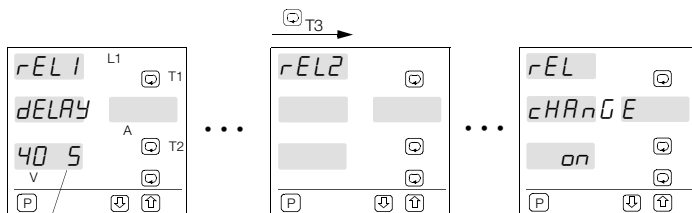

Relay 1
Delay 40 s

Relay 2
same as Relay 1

⏏⏏: Value setting on/dip disables changes to relay parameters:

⏏⏏: Value setting

- 0
- 1, 2, 3, 5, 8, 15, 25, 40 s
- 1, 2, 3, 5, 8, 15, 30 min

Changes to relay parameter settings can be either disabled or enabled with the "LOCK" DIP switch. For example:

1. Enable changes to all parameters:
'LOCK' = position OFF, rel change = dip or on
2. Disable changes to all parameters:
'LOCK' = position on, rel change = dip
3. Disable changes to all parameters except for relay parameters:
'LOCK' = position on and rel change = on

rel change can only be set to "on" if "LOCK" has previously been set to OFF.

4.2 Adjustment of Display Brightness and Filter

Adjusting display brightness

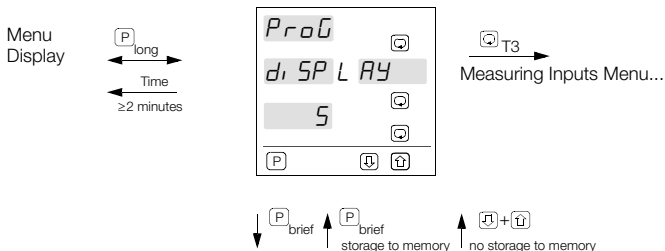

Adjusting display filter

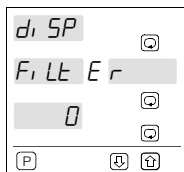

Parameters for display brightness

T T: Adjustment of values

The values are adopted immediately upon entry.

0 ... 7

For permanent setting, however, storage to memory is recommended.

0 minimum brightness

7 maximum brightness

Parameters for display filter

 : Adjustment of values

Time constant τ in s

0 ... 30

0 no filter effect

30 maximum filter effect

The display filter is a software filter which acts as a lowpass function with the time constant τ .

A time constant between 0 and 30 s can be set to stabilize the display in the event of fluctuating input signals or interfering signals. If an input signal soars abruptly, the displayed value adjusts only gradually to the actual value, in line with the selected time constant. After 5τ almost 100% of the input signal are displayed.

Set the time constant to 0, if the changes are to be displayed immediately and in an unfiltered manner.

4.3 Measurement Inputs, Configuring the Synchronizing Input

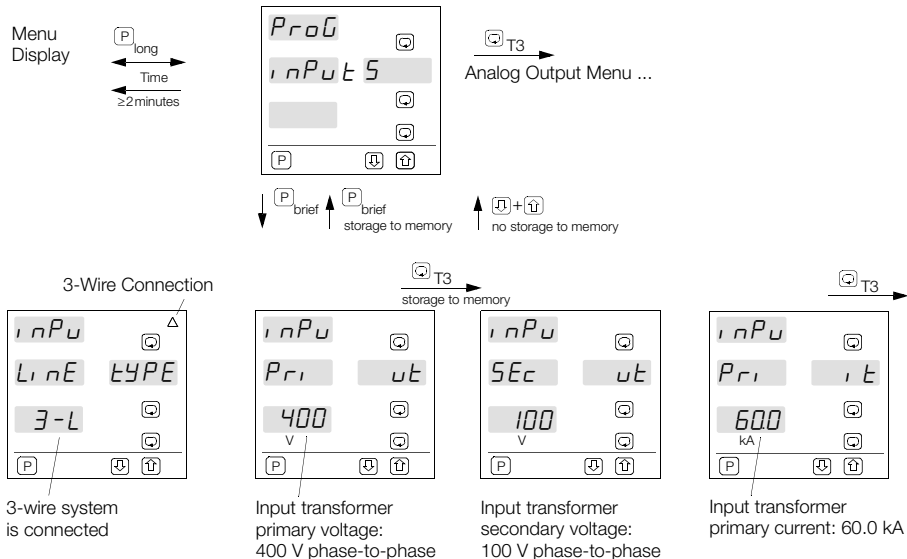

$\overrightarrow{T+T}$: Value Settings

- 4L and display of \swarrow for 4-wire non-balanced load
- 3L and display of Δ for 3-wire non-balanced load
- 3L-1 and display of Δ for one current transformer and display of Δ
- 3L13 and display of Δ for one current transformer and one phase-to-phase voltage
- 4L13 and display of \swarrow for 4-wire non-balanced load and open-Y connection (see chapter 2.2)

$\overrightarrow{T+T}$: Value Settings

- 100 V ... 700 V in 1V steps
- 500 V ... 800 kV in 100 V steps

$\overrightarrow{T+T}$: Value Settings

- 100 V ... 500 V in 1 V steps

$\overrightarrow{T+T}$: Value Settings

- 1 A ... 150 kA
- 5 A steps for $I_t < 5\text{kA}$
- 50A steps for $I_t > 5\text{kA}$
- 500A steps for $I_t > 50\text{kA}$

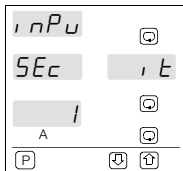

Input transformer
secondary current: 1.00 A

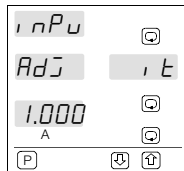

Input transformer
adjustment
current transformer

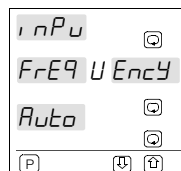

Line frequency
synchronization

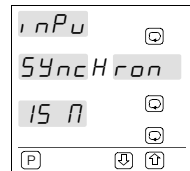

Synchronizing pulse
every 15 minutes

: Value Settings

1 or 5 A

: Value Settings

0.900 ... 1.100

: Value Settings

Auto All phases,
voltage and
current are
scanned.

U1-3 Only voltages
are used.

: Value Settings

external, 1 ... 60 minutes

Ext ext. synchroniz-
ing pulse to synchronizing
input, or internal with
selection of interval from 1
to 60 min.

4.4 Configuring the Measuring Inputs, Analog Inputs (feature A3) (not with LON and Profibus-DP)

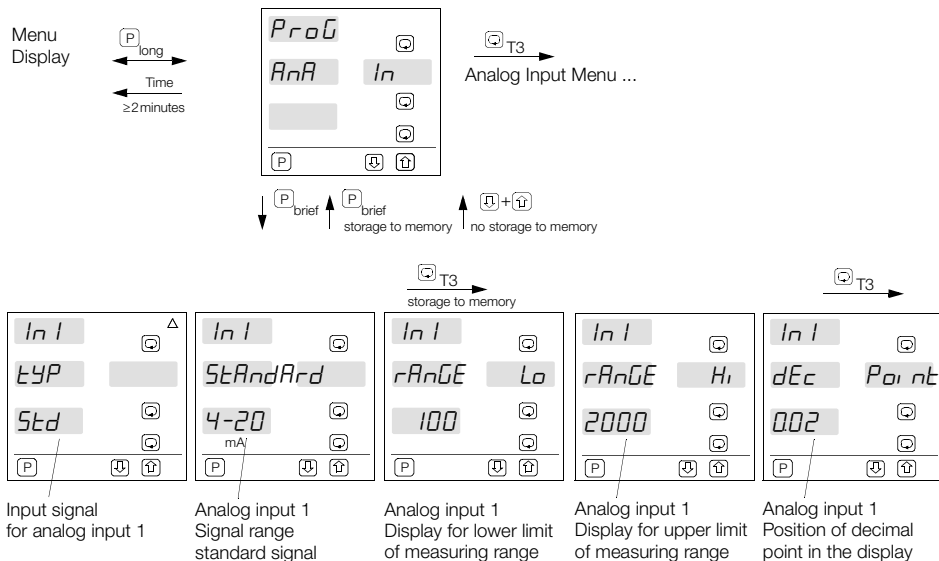

	U+U: Type Setting	U+U: Value Settings			U+U: Value Settings	U+U: Value Settings	
		Display	Volt	mA		Display	Places behind the decimal point
Std	Standard Signal 10 V/20 mA	4-20	2-10	4-20	-1999 ... 9999	-1999 ... 9999	
		0-20	0-10	0-20			
		2020	± 10	± 20			
Pt1k	Temperature Sensor Pt1000	1010	± 5	± 10			
	DIP					0.	0
	In1:	<input checked="" type="checkbox"/>	<input checked="" type="checkbox"/>	<input type="checkbox"/>	ON	0.1	1
		<input type="checkbox"/>	<input type="checkbox"/>	<input checked="" type="checkbox"/>	OFF	0.02	2
						0.003	3

The associated DIP-switches must be set correctly!

T3 →

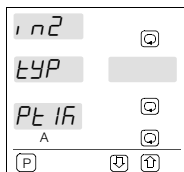

Input signal
for analog input 2

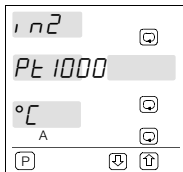

Analog input 2
Display dimension



Analog input 2
Correction of measuring
error by cable resistance

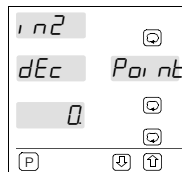

Analog input 2
Display resolution

: Type Settings

Std Standard signal
10 V/20 mA

Pt1k Temperature
sensor Pt1000

: Value Settings

°C degrees Celsius
°F degrees Fahrenheit

DIP
In2:

The associated DIP
switches must be set
correctly!

: Value Settings

The preset value is added
to the measured value.

: Value Settings

Display Resolution
0.1 integral degrees
0.1 tenth of a
degree

4.5 Configuring the Analog Outputs (not with Profibus-DP)

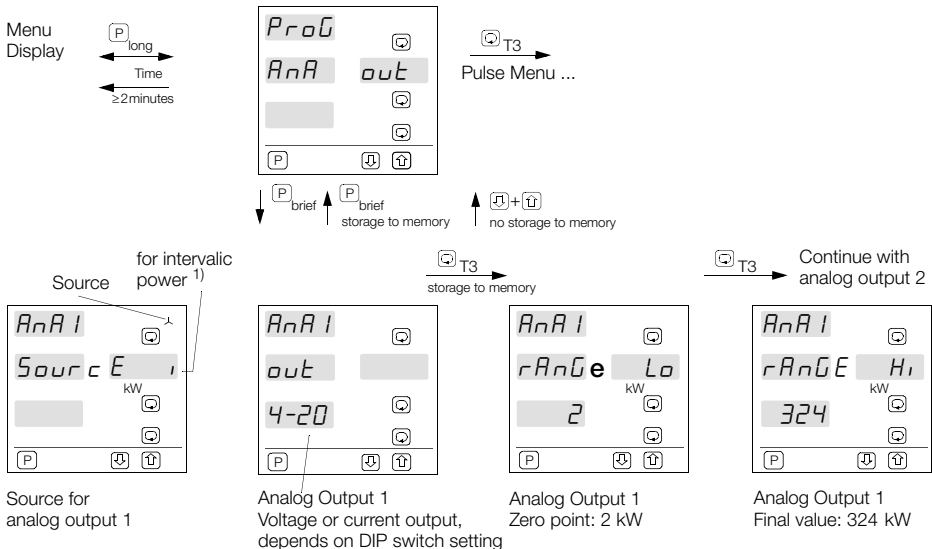

T1: Source Selection

L1, L2, L3 Individual phases
L12, L23, L13 Phase-to-phase voltage
Collective Values
L123 Neutral conductor current

$\text{U} \text{U}$: Value Settings

4-20 = 2-10V or 4-20mA

Output Quantities

Display Volt mA

0-20 0-10 0-20
4-20 2-10 4-20

$\text{U} \text{U}$: Value Settings

0 ... 9999

for P:

-999 ... 9999

$\text{U} \text{U}$: Value Settings

0 ... 9999

for P:

-999 ... 9999

T2: Meas. Quantity Selection

V_{Δ} , V, A, A_{AVG} , W,
VAr, VA, ϕ , Hz, Wi,
VAri, VAi, external

2020 ± 10 ± 20

1010 ± 5 ± 10

DIP A1: ON OFF
(Out1)

The appropriate DIP switches
must be set correctly!

The same windows and values apply to analog output 2.
Analog outputs 3 and 4 may also be optionally included.

¹⁾ The source is relative to the latest completed interval value ($P_{\Sigma int}$, $Q_{\Sigma int}$, $S_{\Sigma int}$) for intervalic power

4.6 Configuring the S0 Pulse Outputs

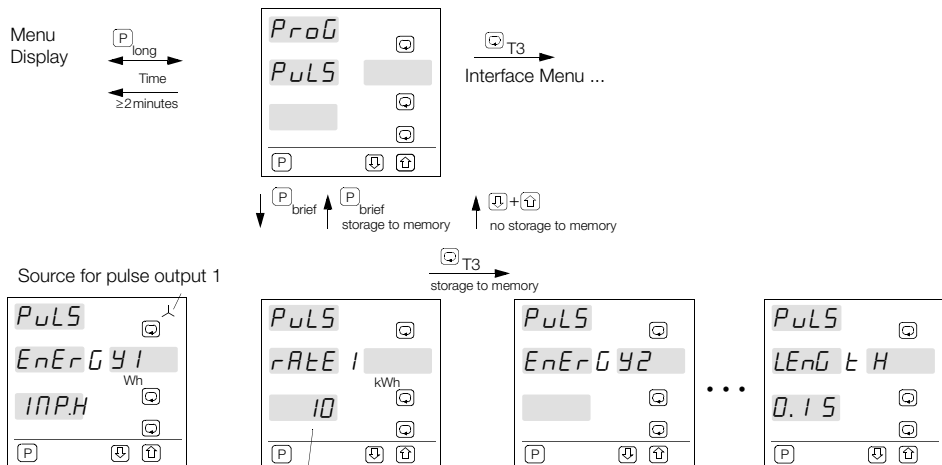

Source, pulse output 1:
collective energy (4L)

Pulse output 1
Pulse rate
10 pulses / kWh

Pulse output 2:
same as pulse output 1

Pulse outputs
Pulse length
0.1 s

- T1: Source Selection
L1, L2, L3, ↵
- T2: Quantity Selection
Active/reactive energy
kWh, kVArh,
Mwh, MVArh

- ⏏ ⏏: Value Settings
- 1 ... 5000 pulses / kWh (MWh)
or kVArh (MVArh)
- Resolution:
1 pulse if rate < 1000
10 pulses if rate ≥ 1000

- ⏏ ⏏: Value Settings
- 0.1 s ... 0.8 s

⏏ ⏏: Value Settings

INPL = import, low tariff; **INPH** = import, high tariff, Import energy from the system (positive sign)
EΞPL = export, low tariff; **EΞPH** = export, high tariff, Export energy to the system (negative sign)

The import and export settings are without significance for reactive energy, which is always indicated with a positive value.

4.7 Data Logger Display and Configuration

Display for Trigger Source Setting rel 1, rel 2, both

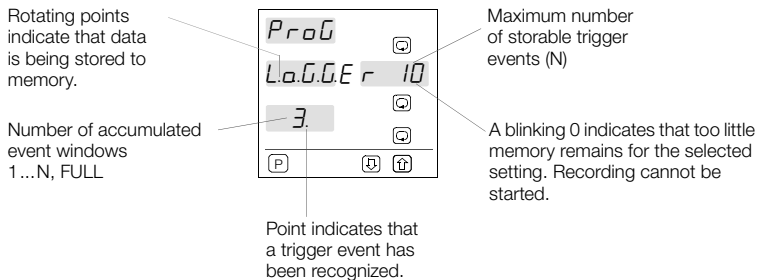



If the data logger is not recording, the display blinks alternately: Logger/stop

Attention:

If the real-time clock has stopped, the display blinks alternately: Logger/time date

Operation of the data logger is interrupted if:

- Memory is full and the memory mode is set to „once“
- If a data logger parameter is changed (display: Logger/stop)
- The data logger is started with  long
- The data logger is stopped with  long

Attention: Memory is cleared when the data logger is started!

Display for parameter setting Trigger Source OFF

Rotating points indicate that data is being stored to memory.

0...99%, FULL
(memory occupancy level)

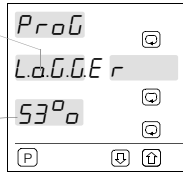

If the power supply is interrupted during a recording session, the A2000 supplements the outstanding samples after restarting the instrument:

- A value of „0“ is entered for all measured quantities, except for energies (last meter reading)
- If a trigger source has been selected, the beginning of power supply interruption is always considered to be a trigger.
- If the trigger source has been set to „OFF“, the beginning of power supply interruption is recorded in the time stamp of the last trigger. (Time stamp of the first trigger = start of recording)
- If power supply interruption takes longer than the remaining storage rate, the current window is completed and a new untriggered window is produced if a trigger source has been selected.
-



In the case of trigger source „OFF“, cyclical memory mode and a power supply interruption which takes longer than the storage rate, the complete memory will be overwritten.

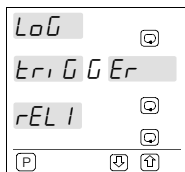
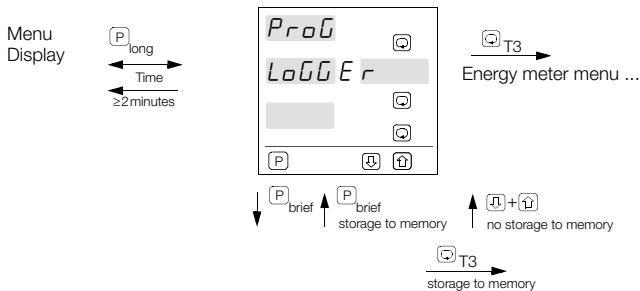

Trigger source setting

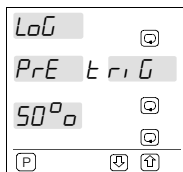

Trigger source setting

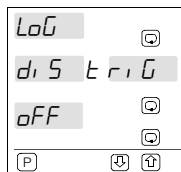

External trigger disabling when trigger source ≠OFF



Data logger Start/Stop when trigger source = OFF

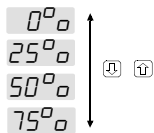
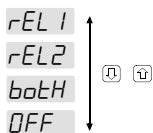

If the trigger source is set to OFF, data is recorded continuously to memory. For data logger an alarm memory is not relevant.

Triggering can be disabled via the synchronization input.

The data logger can be launched and stopped via the synchronization input. Start and Stop via keyboard are not possible in this case.

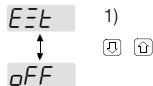

1) If the external input is used as a synchronizing input, no switching to external is possible. (Display: -no-)

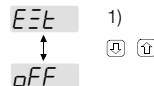

1) If the external input is used as a synchronizing input, no switching to external is possible. (Display: -no-)

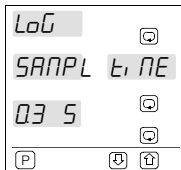

Sampling time

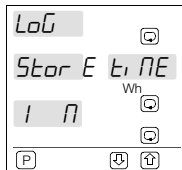

Storage rate

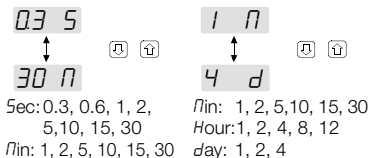

Sampling time T_{sa} , storage time T_{st} and number of traces ΣTr result in a maximum number of storable trigger events N with a memory capacity of 512 kByte

$$N = (250000 \times T_{sa}) / (T_{st} \times \Sigma Tr)$$

(Round N up to whole number: $N_{min} = 1$, $N_{max} = 99$)

If the display blinks when the value is selected, the memory is too small for the selected setting.

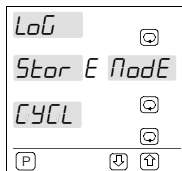

Memory is overwritten cyclically when full.

T3
storage to memory

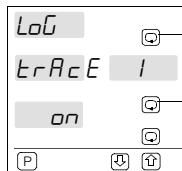

Source selection
see T1 below

Measuring quantity selection
see T2 below

Selection of max. 12 quantities to be recorded

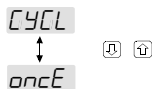
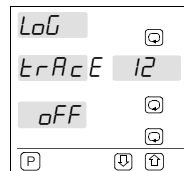

The data logger is stopped when memory is full.

T1: Source Selection

L1, L2, L3 Individual phases
L12, L23, L13 Phase-to phase voltage
∩ Collective Values
L123 Neutral conductor current

T2: Meas. Quantity Selection

V_{Δ} , V , A , A_{AVG} , W ,
 VAR , VA , ϕ , Hz , Wi ,
 $VAri$, VAi , Wh ,
 $VARh$, Ahd , Vhd , OFF

The source is relative to the latest completed interval value for interval power ($P_{\Sigma int}$, $Q_{\Sigma int}$, $S_{\Sigma int}$)

If source is set to "off", all subsequent traces are of no significance (menu jumps to start trigger).

4.8 Configuring the Energy Meter Mode/Low Tariff

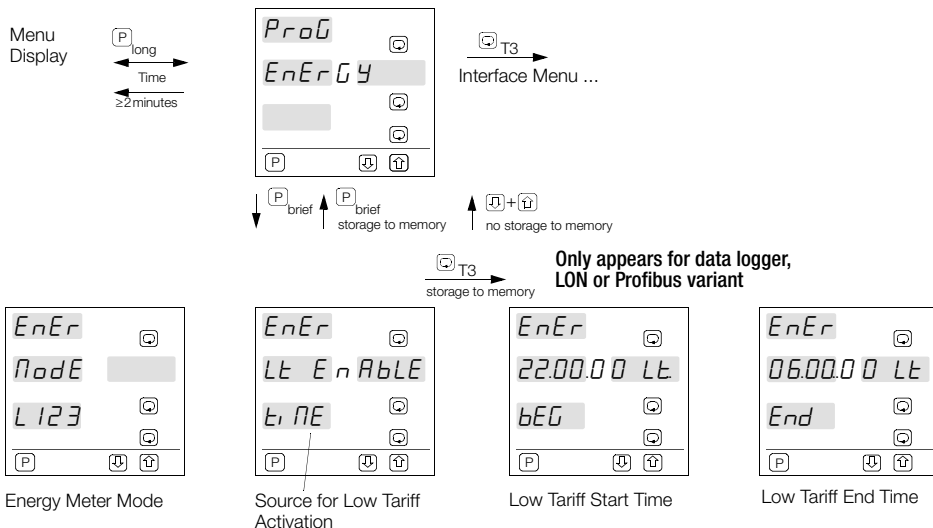

⏏ ⏏ : Mode setting
L123 = Individual phases
LtHt = Low tariff high tariff (import / export)
 Active and reactive energy

This setting only refers to the energy meters and not to the pulse outputs. After switch-over it is advisable to delete the meter readings, see chapter 4.10 on page 38.

⏏ ⏏ : Source setting
Lt NE = Internal clock with data logger.
noLt = Variant without data logger does not provide for low tariff function via clock.
EEt = Switch-over via synchronizing input
Lt = input short-circuited
Ht = input open

Setting same as for clock, see chapter 4.10 on page 38!!
 (seconds remain at zero)

If only high tariff is requested, select the same value for start time and end time.

4.9 Interface Configuration

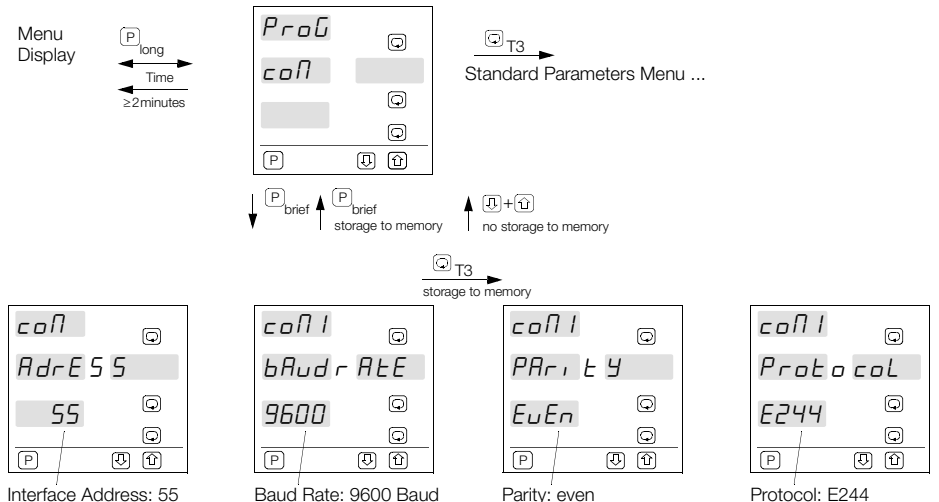

Interface Address: 55

Baud Rate: 9600 Baud

Parity: even

Protocol: E244

U U : Value Settings

0 ... 254

(for variants with Profibus-DP: all addresses > 126 are interpreted as initialization address 126!)

U U : Value Settings

1200, 2400, 4800,
9600, 19.20k

U U : Value Settings

EUn = even
odd = odd
SPcE = space
no = no

U U : Configuring the Communications Protocol

E244 = DIN draft
19244
B70 = EN 60870
Mod1 = Modbus
new version
Mod2 = Modbus
previous version

These values apply to both the RS485 and the RS232. However, both interfaces cannot be operated simultaneously.

Only appears for LON interface variant:

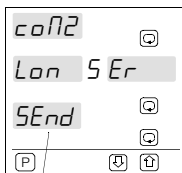

LON service, only if key is pressed and held

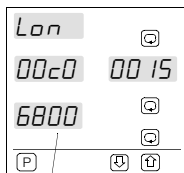

LON ID: 00c000156800

 T3
storage to memory

Only appears for Profibus DP variant:

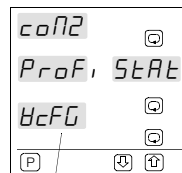

Status: Wait Config

 : LON service

 : Status:

HcFG = Wait Config
hPAr = Wait Parameter
dRE = Data Exchange
Err = Error

Only one of these two variant options can be installed. The RS-485 interface is omitted for the LON interface variant, and the RS-485 interface with analog outputs is omitted for the Profibus DP variant.

4.10 Uploading and Deleting Parameters, Setting the Clock

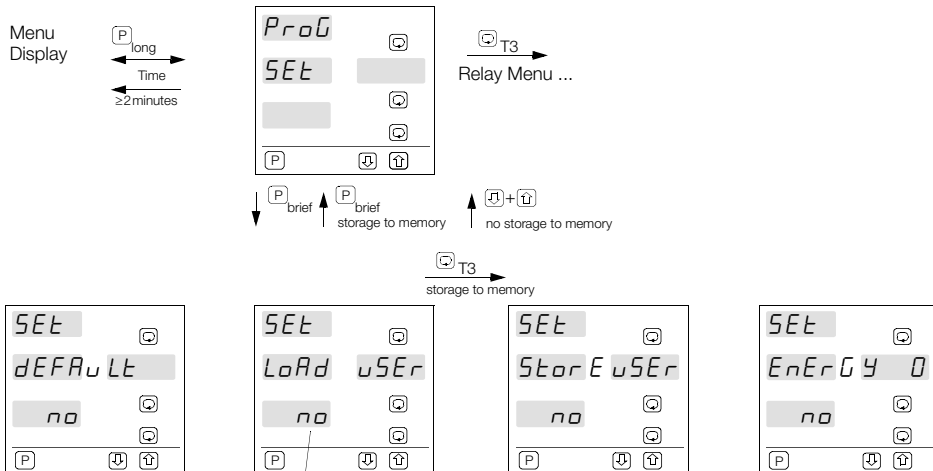

Do not upload default parameters (factory presets)

Do not upload user parameters

Do not store user parameters

Do not delete meter readings

U **T**: settings no/yes. For reasons of safety, the **T** or **U** key must be pressed and held for more than 2 sec.

————— yes loads/stores the corresponding parameters —————

————— yes deletes all —————
meter readings

 T3
 storage to memory

**Only appears for data logger,
 LON or Profibus variant**

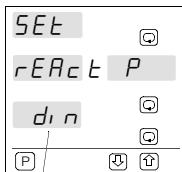

Selection: with or without + or - sign

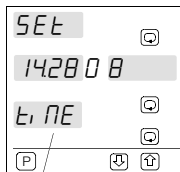

Selection and storage of hours and minutes (corresponding display blinks)

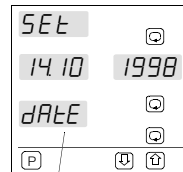

Selection and storage of day, month and year

: Status:

dIn = Reactive power per DIN 40110 without + or - sign

SIn = Reactive power with + or - sign

$CapP$ = Compensating reactive power

$FErr$ = Ferraris meters

: Selection:

Adjust hours and minutes (seconds are set to zero when time is saved to memory)

: Selection:

Adjust day, month and year

5 Electrical Connections and Circuits

Design with 2 or 4 analog outputs and serial interface RS-232 and RS-485 or LON

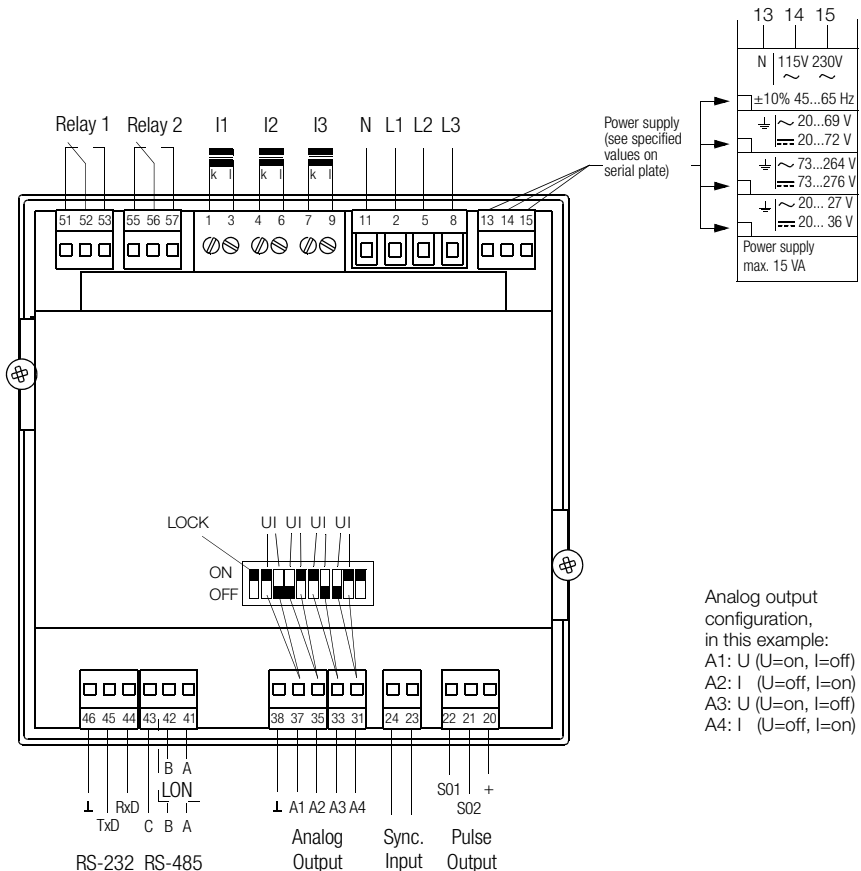

Design with 2 analog inputs and 2 outputs and serial interface RS-232 and RS-485

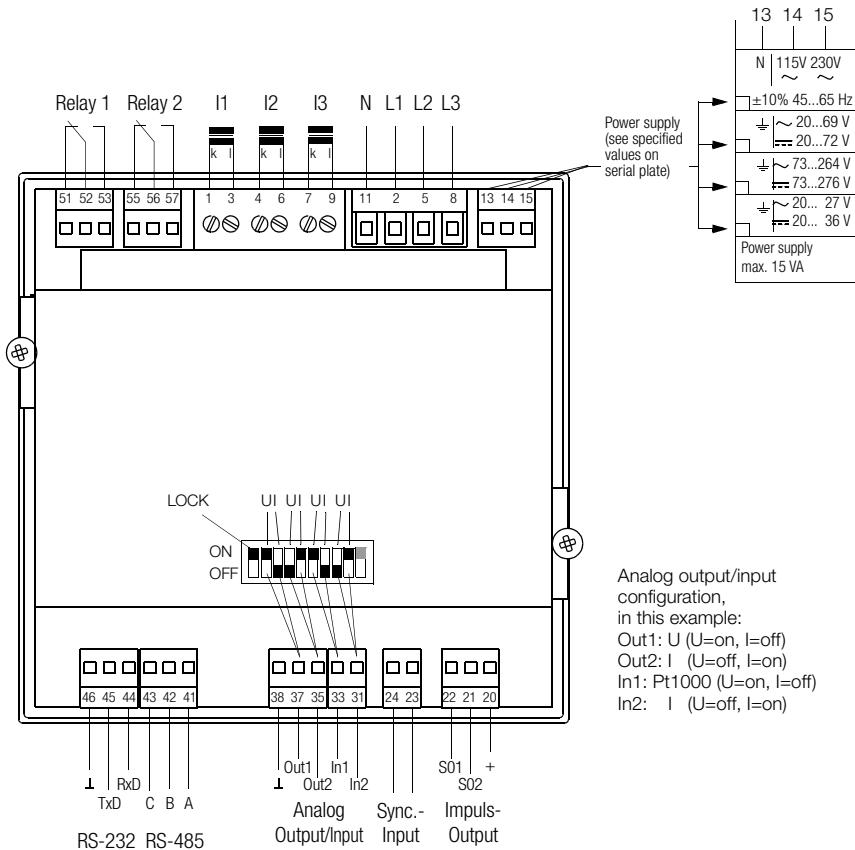

RS-232 Pin Assignments

Sub-D plug at PC		
No. of pins	25	9
DCD	8	1
RxD	3	2
TxD	2	3
DTR	20	4
Gnd	7	5
DSR	6	6
RTS	4	7
CTS	5	8

A2000
RS-232
TxD
RxD
⊥

RS-485 Pin Assignments (not included with LON variant)

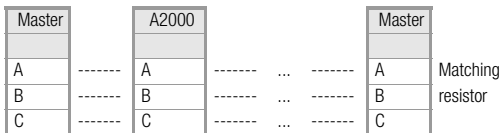

Profibus DP connection (optional)

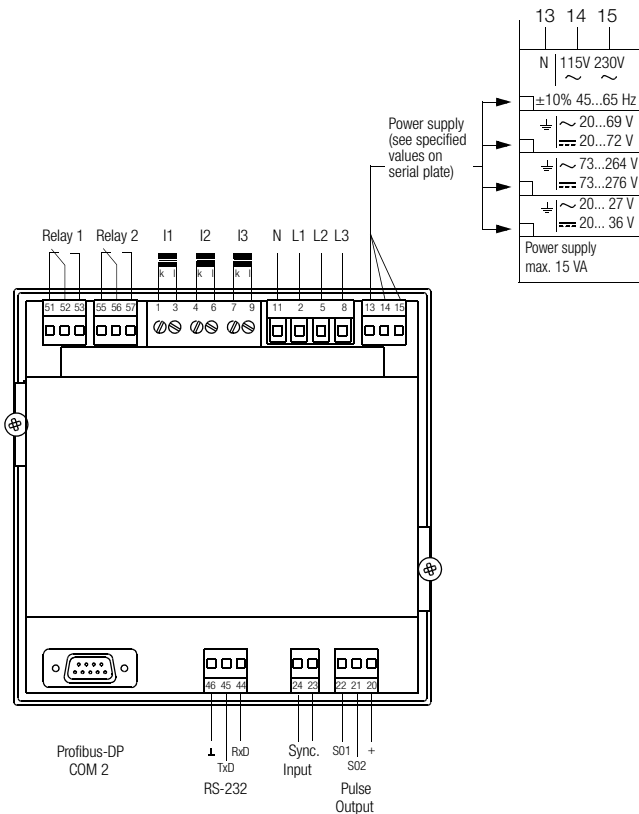

Electrically Isolated Circuits

Voltage Inputs
L1
L2
L3
N

Current Inputs
I1
I2
I3

Synchronizing Input

Power Supply
(per serial plate specs)
Attention:
The device is not equipped
with an integrated circuit-
breaker

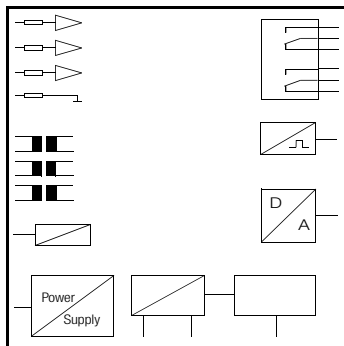

RS232, RS485
Interface

LON or
Profibus-DP-
Interface
(optional)

Limit Value Relay 1

Limit Value Relay 2

Pulse Outputs
S01, S02 (optional)
common reference point +

Analog Outputs
A1, A2, (A3, A4 optional)
Analog inputs
(Option In1, In2)
common reference point ⊥

6 Interface Description

The following sub-chapters include a brief description of the interfaces.

Please refer to the following manuals on our [homepage](#) if you require a detailed description of the interface protocols:

Communications Protocol per DIN draft 19244
Communications Protocol per EN 60870
Communications Protocol per Modbus – *Mod 1* –
Communications Protocol per Modbus – *Mod 2* –
LON Interface
Profibus Interface

Reference No. 3-349-125-03
Reference No. 3-349-128-03
Reference No. 3-349-225-03
Reference No. 3-349-129-03
Reference No. 3-349-091-03
Reference No. 3-349-092-03

6.1 General

The instrument is equipped with an RS232, as well as an RS485 interface as standard equipment. However, only one interface may be operated at any given time. If a LON interface has been installed (optional), the RS485 interface is not included. See chapter 5 on page 40 for electrical connections. If the optional Profibus DP interface has been installed instead of the LON interface, the RS-485 and the analog outputs are omitted. See the Profibus DP interface description for electrical connections.

- Char. format: 8 data bits, 1 parity bit, 1 stop bit
- Parity: even, odd, space, no

The following settings are required in order to fulfill the requirements set forth in the respective standards:

- DIN draft 19244: even, if operated at a modem: no
- EN 60870: even
- Modbus: even, odd, no

RS-232

Depending upon the driver software, it may be necessary to install jumpers at the master, e.g. DCD+DTR+DSR and RTS+CTS.

RS-485

If the RS485 interface is used, up to 32 instruments can be interconnected via the bus. In this case, all ABC terminals are connected to one another in parallel. Wiring must be carried out from one instrument to the next; star networks may not be implemented. For bus cables of greater than 5 meters in length, the bus should be terminated at both ends with a surge impedance (e.g. 200 Ω between A and B).

6.2 Communications Protocol

The communications protocol in accordance with DIN draft 19244, EN 60870 or the Modbus protocol is used for communications between the field control and device levels. The A2000 utilizes only a subset of the functions defined in the protocol. Separate descriptions are available for each of the individual communications protocols.

The following functions are not used: query acknowledgement for individual characters and transmission control by means of record sequence bit.

Time Response Characteristics

Ready to transmit/receive after start-up	$t_{ber} > 5 \text{ s}$
Character delay time (A2000 transmitter)	$t_{zvs} < 3 \text{ ms}$
Character delay time (Master)	$t_{zvm} < 100 \text{ ms}$
Response delay time (A2000 transmitter)	$10 \text{ ms} < t_{av} < 100 \text{ ms}$
Query waiting time after response from A2000 (master)	$t_{aw} > 10 \text{ ms}$

7 Dimensional Drawing

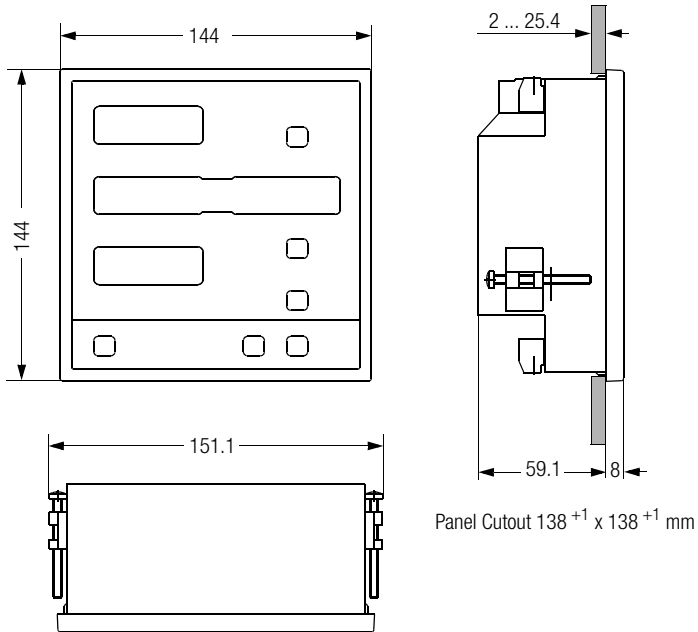

All dimensions in mm

8 Technical Data

Measurement Inputs

Voltage Inputs

Phase – Phase 0 ... 500 ... 550 V,
40 ... 70 Hz

Phase – N (ground) 0 ... 290 ... 320 V,
40 ... 70 Hz

Overload 1.2-fold

Intrinsic Impedance > 290 k Ω

Power Consumption < 1,1 W

Current Inputs

0 ... 1 ... 1.2 A

0 ... 5 ... 6 A

Overload 1.4-fold cont.

30 A / 10 s, 100 A / 3 s

Power Consumption < 150 mW

Sampling Rate 32 samples per period
per measurement value

Measuring Error NV = nominal value,
MV = measurement value
 $\pm (0.25 \% \text{ of NV} + 1 \text{ digit})$
for MV > 2 % of NV

Voltage $\pm (0.25 \% \text{ of NV} + 1 \text{ digit})$

Power, Energy $\pm (0.5 \% \text{ of NV} + 1 \text{ digit})$

Power Factor ± 0.02 for U, I > 10 % of NV

Frequency ± 0.02 Hz

4-Quadrant Operation Measurement:
import and export,
inductive and capacitive

Analog Inputs

MR = Measuring Range

– Standard

Standard signal:
(20 mA: 4 ... 20 mA,
0 ... 20 mA, ± 20 mA,
 ± 10 mA) or
(10 V: 2 ... 10 V, 0 ... 10 V,
 ± 10 V, ± 5 V)

Scaling: (range Lo / Hi)

Pt1000 – Skalierung:
Dimension ($^{\circ}\text{C}$, $^{\circ}\text{F}$), Offset,
decimal point

– Temperatur

Signal Frequency DC
Sampling Interval 640 ms

– Current

Measuring Ranges 0 ... 20 mA, 4 ... 20 mA,
 ± 20 mA, ± 10 mA

Load 45 Ω

Measuring Error $\pm (0.2 \% \text{ MV} + 0,1 \% \text{ of MR})$

Overload permanent 50 mA

– Voltage

Measuring Ranges 0 ... 10 V, 2 ... 10 V, ± 10
V, ± 5 V

Input Resistance 112 k Ω

Measuring Error $\pm (0.3 \% \text{ MV} + 0,1 \% \text{ of MR})$

Overload permanent 100 V

– Pt1000 (according to EN 60751)

Connection 2-wire

Measuring Range 185 ... 3905 Ω
(–200 ... 850 $^{\circ}\text{C}$)

Measuring Error $\pm (0.5 \% \text{ MV} + 1 \text{ }^{\circ}\text{K})$

– Display Values

for Standard Signal	
Lower/Upper Range Limit	–1999 ... +9999 configurable
Resolution	depending on range and position of decimal point

at Pt1000

Lower/Upper Range Limit	–200 ... 860 °C (–328 ... 1580 °F)
Resolution	0.1 or 1 °C/°F
Offset	adjustable from –100 to +100 °C/°F

Interfaces

	RS-232 and RS-485 alternatively: RS-232 and LON or RS-232 and Profibus-DP
Baud Rate	1200, 2400, 4800, 9600, 19200 baud
Parity	even, odd, space, no
Protocol for RS-232 and RS-485	selectable: GMC device bus (DIN draft 19244), EN 60870 or Modbus (RTU)

Synchronizing input

On	short-circuited with $R < 10 \Omega$
Off	open with $R > 10 M\Omega$

Pulse Outputs

Contact	open collector
Current	ON 10 mA ... 27 mA OFF < 2 mA
External Voltage	8 ... 30 V
Pulse Duration	selectable 100 ... 800 ms
Interpulse Period	≥ 10 ms

Analog Outputs

Output Quantity	configurable
Current	
Ranges	0 ... 20 mA, 4 ... 20 mA, ± 20 mA
Load	max. 500 Ω
Load Effect	< 0.8 $\mu\text{A} / \Omega$ (0 ... 250 ... 500 Ω)
Resolution	0.1 % of control range
Error Limit	± 0.5 % of final value
Voltage	
Ranges	0 ... 10 V, 2 ... 10 V, ± 10 V
Load	< 20 mA
Load Effect	no effect to > 10 K Ω
Resolution	0.1 % of control range
Error Limit	± 1.0 % of final value
where control range = upper range limit – lower range limit, e.g. 1200 W = 1500 W – 300 W (freely selectable values)	

Relay Outputs

Switching Capacity	~ / $\overline{\text{---}}$ 250 V, 2 A 500 VA / 50 W (nominal load)
Service Life	> 500000 switching cycles

Display

Type	7-Segment LED
Display Color	red
Character Height	13.2 mm

Display Range

Energy	999999999
Power Factor	1.00
Other Quantities	9999

Internal Clock

(only in version with datalogger, LON or Profibus)

Accuracy	< 2.5 s/day
Power Supply	lithium cell, life cycle appr. 8 years

Power Supply

Supply Voltage

Feature H0	230 V / 115 V $\sim \pm 10\%$ 45 ... 65 Hz
Feature H1	20 ... 69 V $\sim 45\ldots 450$ Hz 20 ... 72 V \equiv
Feature H2	73 ... 264 V $\sim 45\ldots 450$ Hz 73 ... 276 V \equiv
Feature H3	20 ... 27 V $\sim 45\ldots 450$ Hz 20 ... 36 V \equiv
Power Consumption	max. 15 VA

The instrument is not equipped with an integrated circuit breaker. Therefore, during installation, care should be taken to ensure that

- the building where the instrument is installed includes a circuit breaker,
- the circuit breaker is positioned in close proximity to the instrument and is easily accessible to the operator,
- it is clearly marked as a circuit breaking device for the instrument.

Electrical Safety

Variants

IEC 61010-1 /
EN 61010-1

Protection Class	II
Measuring Category	inputs: III, relays: II
Contamination Level	2
Operating Voltage	300 V \sim / \equiv
Test Voltage	measuring inputs: 3.7 kV

Protection

Front Panel	IP 52
Housing	IP 30
Terminals	IP 20

Fuses

The supply circuit is protected by an internally soldered fuse.

Feature H0	T160mA/250V
Feature H1	T1A/250V
Feature H2	T250mA/250V
Feature H3	T1.25A/250V

EMC

Interference Emission/ Interference Immunity	IEC 61326 / EN 61326
---	----------------------

Ambient Conditions

Operating Temp.	0 ... 50 °C
Storage Temp.	- 25 ... 70 °C
Relative Humidity	75% no condensation

Housing

Front Dimensions	144 x 144 mm
Panel Cutout	138 ⁺¹ x 138 ⁺¹ mm
Bezel Height	8 mm
Installation Depth	59.1 mm
Weight	1 kg (without packaging)
Mounting	DIN screw clamps
Terminals	screw clamp terminal blocks

9 Maintenance – Device Return and Environmentally Sound Disposal

Maintenance

The A2000 does not require maintenance at regular intervals.

Device Return and Environmentally Sound Disposal

The A2000 is a category 9 product (monitoring and control instrument) in accordance with ElektroG (German electrical and electronic device law). This device is subject to the RoHS directive. Furthermore, we make reference to the fact that the current status in this regard can be accessed on the Internet at www.gossenmetrawatt.com by entering the search term WEEE.

We identify our electrical and electronic devices in accordance with WEEE 2012/19EU and ElektroG with the symbol shown to the right per DIN EN 50419.

These devices may not be disposed of with the trash. Please contact our service department regarding the return of old devices (see chapter 9).



10 Repair and Replacement Parts Service Calibration Center and Rental Instrument Service

When you need service, please contact:

GMC-I Service GmbH
Service-Center
Thomas-Mann-Straße 20
90471 Nürnberg, Germany
Phone +49 911 817718-0
Fax +49 911 817718-253
E-mail service@gossenmetrawatt.com

This address is only valid in Germany.

Please contact our representatives or subsidiaries for service in other countries.

11 Product Support Industrial Division

When you need support, please contact:

GMC-I Messtechnik GmbH
Product Support Hotline – Industrial Division
Phone +49 911 8602-500
Fax +49 911 8602-340
E-Mail support.industrie@gossenmetrawatt.com

Edited in Germany • Subject to change without notice • A pdf version is available on the internet



GMC-I Messtechnik GmbH
Südwestpark 15
90449 Nürnberg • Germany

Phone +49 911 8602-111
Fax +49 911 8602-777
E-Mail info@gossenmetrawatt.com
www.gossenmetrawatt.com