

Electronic DC Loads

LOW POWER PLA SERIES

Production Series A



- DC loads
- Low Power
- I/O port as standard
- Optional Ethernet/USB/RS-232, CAN, GPIB
- Basic operating modes CC, CV, CR, CP
- Combined operating modes CC+CV, CP+CV, CR+CV, CP+CC, CR+CC, CV+CC
- MPP Tracking
- SCPI programming with measurement
- Watchdog function in remote operation
- 19 inch installation possible
- Front and rear load inputs
- Silent cooling
- Adjustable protections for current and voltage
- Dynamic loads
- Temporary overload capacity up to 1.5 fold power, depending on model
- Electronic protection

PLA Series – Brief Profile

The electronic loads of PLA series combine the classic design of large, easy-to-read displays with modern interfaces and a wide range of functions. The devices can optionally be equipped with various data interfaces. In addition to Ethernet, USB and RS-232, a CAN interface can also be installed as an option. GPIB is also available as an option for devices from 400 W upwards. An I/O port is available as standard.

Interfaces

- RS-232
- USB
- LAN
- GPIB
- CAN
- Analog
- Analog isolated

● Standard ○ Option — not available

Operating Modes

The devices have the basic operating modes constant current, constant voltage, constant resistance, and constant power (CC, CV, CR, CP Mode). In addition, a limit value for voltage or current can be specified in each operating mode. This results in the combined operating modes CC+CV, CP+CV, CR+CV, CP+CC, CR+CC, CV+CC.

Protection, Monitoring

- Current limitation
- Power limitation
- Overtemperature protection
- Overvoltage indication
- Undervoltage protection
- Protection of the GND lines at the I/O port

Loading Capacity

There are 24 different models with 4 power classes of 200 W, 400 W, 800 W and 1200 W. In addition, the models up to 300 V have an overload capability. The level and duration of the possible overload depends on the temperature of the power stage. Therefore the units can be used even for considerably more powerful applications for a short time.

I/O-Port

Analog signals
in realtime!

Standard I/O Port for:

- Analog load setting I and V
- Load on/off
- Analog voltage monitor output 0 ... 10 V
- Analog current monitor output 0 ... 10 V

Factory Calibration Certificate (FCC-PLAxx)

2 x for free

We supply a free Factory Calibration Certificate (FCC) with the devices. The calibration process is subject to supervision in accordance with DIN EN ISO 9001. This calibration certificate documents the traceability to national standards to illustrate the physical device in accordance with the International System of Units (SI). Within the 2-year warranty period, we will calibrate a second time free of charge if the respective device will have been registered:

<https://www.hoecherl-hackl.com/service/device-registration>

For use under laboratory conditions, H&H recommends a calibration interval of 2 years. This is an empirical value that can be used as a guide for the first period of use. Depending on the intended use, service life, relevance of the application and ambient conditions, the operator should adjust this interval accordingly.

Drivers



Current NI-certified LabVIEW drivers can be downloaded here:
www.ni.com/downloads/instrument-drivers/

Overcurrent and Undervoltage Protection

An overcurrent or undervoltage protection may be activated and varied. The active protection works in all operating modes.

Undervoltage protection works in two different modes:

- regulating transition at slow regulation speed (e.g. battery discharge)
- switching transition at fast regulation speed (short dead time, e.g. when switching the input voltage)

Load Profiles (List Function)

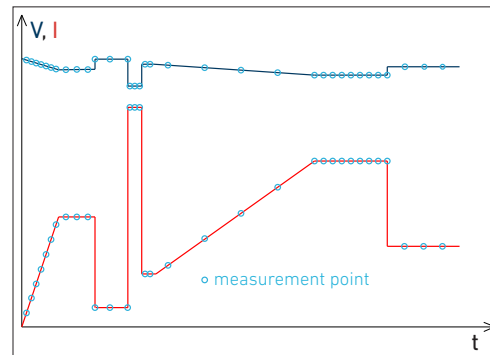

Waveform generated by LIST function with synchronized data acquisition of time, voltage, current

In all operating modes the electronic load can produce load profiles by LIST function. Up to 100 settings with variable dwell and ramp times are possible. Sample times can be defined for each section separately. The electronic load synchronously measures voltage and current and saves the data with timestamp.

Data Acquisition (DAQ)

In digital remote operation the electronic load can save voltage and current synchronously with timestamps. You decide if recording shall stop when the buffer is full or if old data shall be overwritten in a ring buffer mode.

V/I Characteristic Curve Function

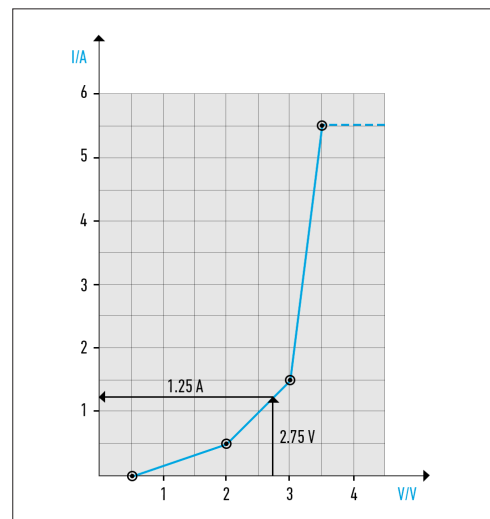

LED characteristic with 4 points

The characteristic curve function maps a sequence of voltage values linearly interpolated to a sequence of current values. The characteristic to be simulated is defined by setting the voltage and current sequence with an SCPI command. Depending on the value of the input voltage, the PLA load sets the current which corresponds to the interpolated point of the characteristic. Up to 100 points are possible.

MPP Tracking

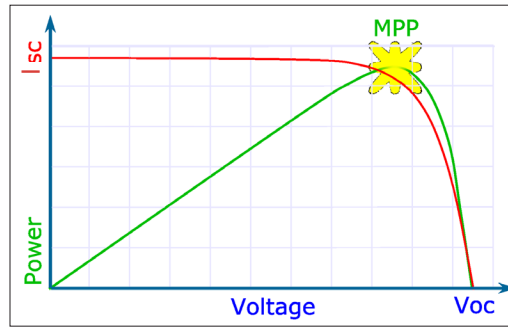

V/I and V/P characteristic of a PV panel

The Maximum Power Point Tracking (MPPT) function consists of the two subfunctions Sweeping and Tracking, which alternate continuously in an adjustable interval.

If the measured open circuit voltage at startup is higher than the minimum voltage, the electronic load performs a sweep and then controls the global MPP found.

The V/I characteristic can be read out via a data interface. It is composed as follows:

<Volt_0>,<Curr_0>,<Volt_1>,<Curr_1>,...,<Volt_99>,<Curr_99>

Watchdog Function

To protect the DUT from communication problems, the electronic load in digital remote control mode has a watchdog function that switches off the load input if the previously programmed watchdog delay time expires without the watchdog being reset.

The watchdog delay time is set by SCPI command, another command activates the watchdog.

When the watchdog is active, a control program must ensure that the command to reset the watchdog is periodically sent to the electronic load.

Master-Slave Operation

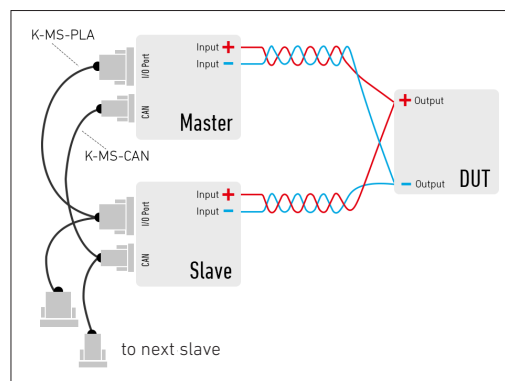

Master-Slave operation in system connection

In order to increase power or current, respectively, up to 5 equal PLA loads may be connected in parallel in Master-Slave operation. The system will outwardly operate like one device.

The Master unit controls the system's whole current, displays total measurement values and sends them in case of query via one of the data interfaces.

Preconditions:

Option PLA01 in all system units, a set of Master-Slave cable K-MS-PLA and K-MS-CAN cable in all Slave units (available from H&H or can be assembled by the user).

Restrictions in Master-Slave operation:

DAQ and characteristic curves are not available in Master-Slave operation. Functions for setting and reading device parameters are only restrictedly available.

The CAN interface is not available for data communication. When using the Master-Slave cable K-MS-PLA the I/O port is not available.

Regulation Speed Setting

For certain DUTs or very long connecting cables, it may be necessary to adapt the regulation time constant of the electronic load in order to achieve stable operation. For this purpose, the control speed can be changed.

Save Settings

The currently active device settings can be saved in non-volatile settings memories from which the settings may be recalled at a later time. 10 memory positions are available. The PLA load can either set reset state or memory position 1 to 9 at power-on.

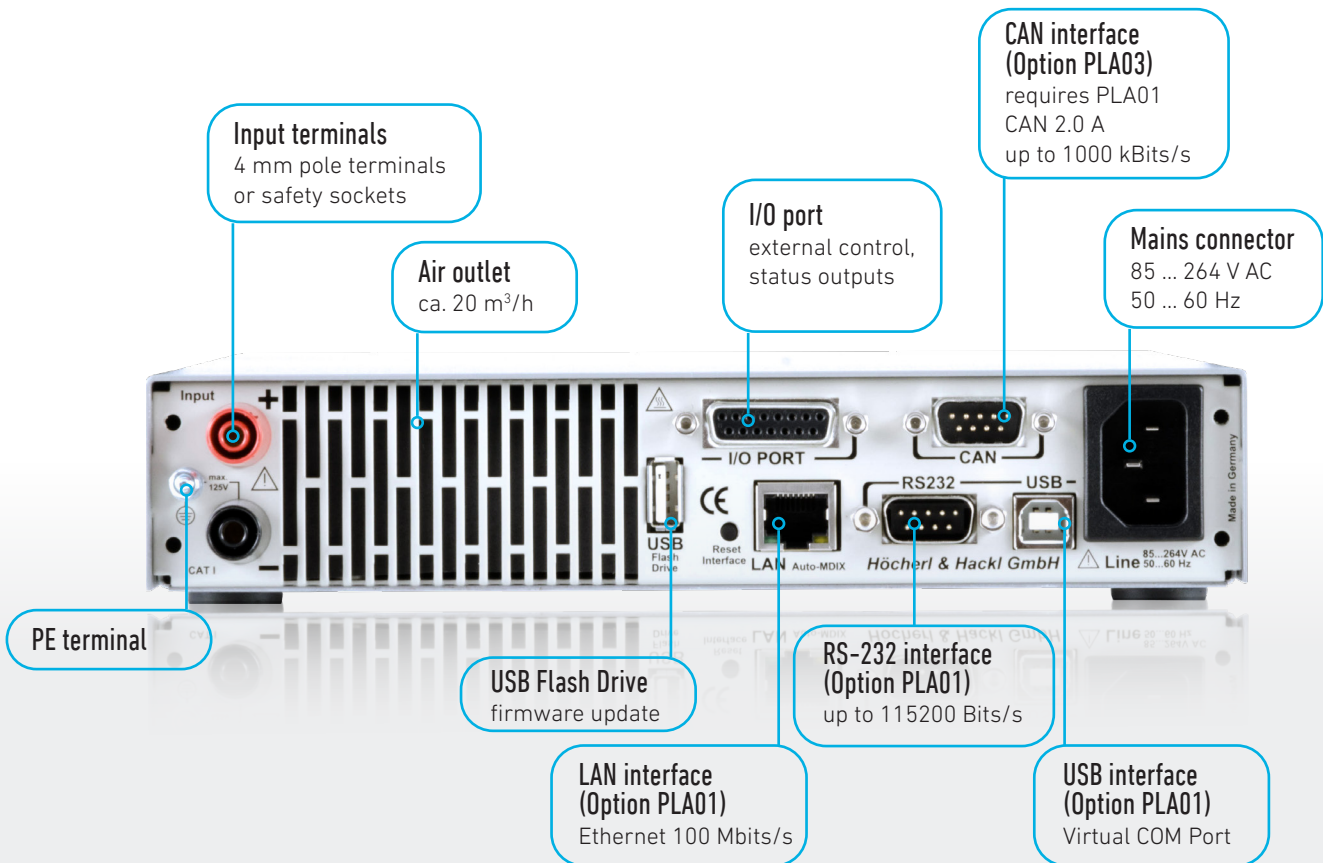
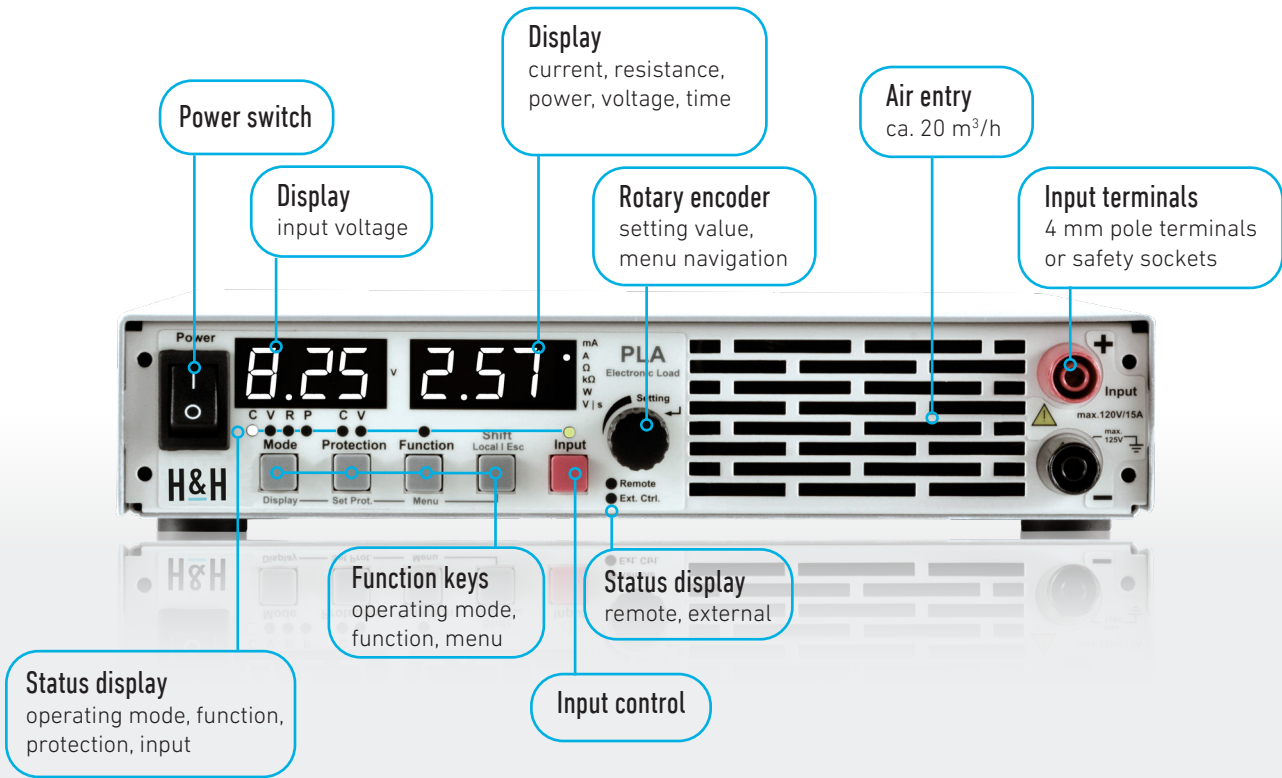

Setting Menu

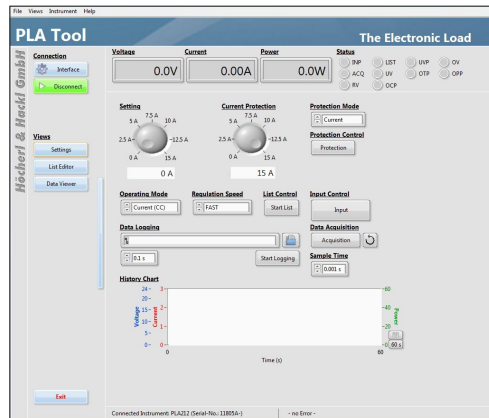

The PLA Tool is a graphical software tool free of charge. It controls PLA series electronic loads. The user can choose different functions with the aid of the navigation bar. The most important load settings are done in the Main Menu ("Settings"). Several graphical widgets inform the user about the measurements and the current device status. Further on, a data logging function can be activated.

www.hoecherl-hackl.com
 -> Download area

Measurement Recorder

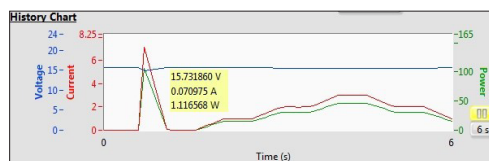

The measurement recorder records the voltage, current and power measured values for a selectable period of time. The period can be changed using the button at the bottom right of the graph. After pressing the Pause key, individual measured values are displayed as tooltips.

List Editor

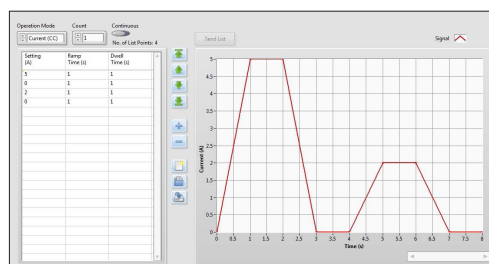

The list editor can be used to easily create dynamic load profiles for the electronic load. The user can enter the nominal setting values for current, voltage, power and resistance, the corresponding rise and fall times and the corresponding dwell times for each interpolation point of the list. The generated list profile can be sent directly to the load via one of the data interfaces or saved on a USB flash drive for further processing.

Data Viewer

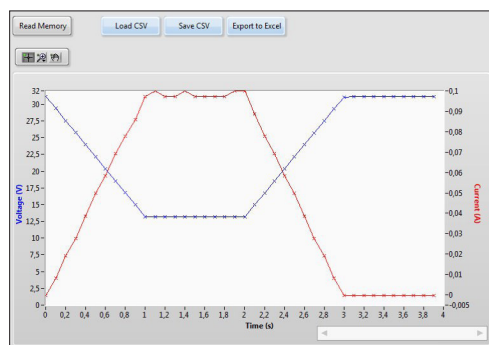

Measurements which are saved in the internal DAQ memory of the device can be read from the device and visualized with the aid of the "Data Viewer". Data can be saved as CSV file for further processing. As the measurement recorder does, the single measurement points (timestamp, voltage, current) are shown as tooltip.

Options, Mechanics and Rack Installation

Option PLA10

Installation kit for 1 device with ½ 19", 1 U



Option PLA11

Installation kit for 2 devices with ½ 19", 1 U



Option PLA12

Installation kit for 1 device with ½ 19", 2 U



Option PLA13

Installation kit for 2 devices with ½ 19", 2 U



Option PLA14

Installation kit for device with ½ 19", 2 U
and 1 device with ½ 19", 1 U



Option PLA15

Installation kit for 1 device with ½ 19", 2 U
and 2 devices with ½ 19", 1 U

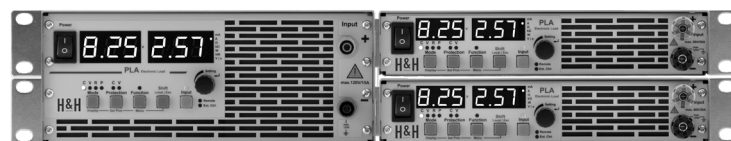

Option PLA16

Carrying handle for 1 device with ½ 19",
1 or 2 U



Option PLA17

Installation kit for 1 device with 19", 2 U

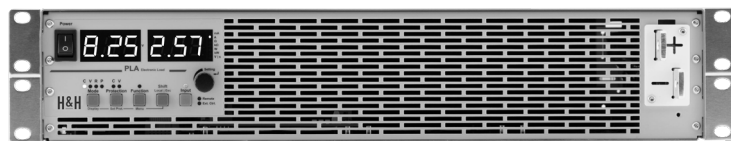

Option PLA18

12 V supply input



Input voltage: 10 ... 18 V DC, reverse-polarity protected
with audible alert
Input current: max. 4 A

Optional Data Interfaces

Option PLA01

Ethernet + RS-232 + USB



Option PLA02

GPIB (only at 400 W, 800 W and
1200 W models. PLA01 necessary)

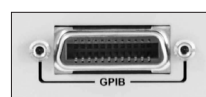

Option PLA03

CAN (PLA01 necessary)



Model (order number)	PLA206	PLA206C4	PLA406	PLA406C8	PLA506
Maximum input voltage V _{max}	60 V	60V	60 V	60 V	60 V
Minimum input voltage V _{min} ¹⁾	1.2 V	1.2 V	1.2 V	1.2 V	1.2 V
Maximum current	30 A	4 A	30 A	8 A	30 A
Continuous power	200 W	200 W	400 W	400 W	500 W
Short-time power ²⁾	300 W	240 W	500 W	480 W	500 W
Voltage setting	0 ... 60 V	0 ... 60 V	0 ... 60 V	0 ... 60 V	0 ... 60 V
Current setting	0 ... 30 A	0 ... 4 A	0 ... 30 A	0 ... 8 A	0 ... 30 A
Resistance setting	67 mΩ ... 133 Ω	500 mΩ ... 1000 Ω	67 mΩ ... 133 Ω	250 mΩ ... 500 Ω	67 mΩ ... 133 Ω
Power setting ³⁾	0 ... 300 W	0 ... 240 W	0 ... 500 W	0 ... 480 W	0 ... 500 W
Rise/fall time ⁴⁾	30 μs	40 μs	40 μs	35 μs	40 μs
Input capacity ca.	1 μF	1 μF	1 μF	1 μF	1 μF
Load terminals ⁵⁾ rear / front	PK4-30L / PK4-30L	PK4-30L / PK4-30L	PK4-30L / PK4-30L	PK4-30L / PK4-30L	PK4-30L / PK4-30L
Power consumption	30 VA	30 VA	37 VA	37 VA	37 VA
Noise max. ⁶⁾	49 dB(A)	49 dB(A)	61 dB(A)	61 dB(A)	61 dB(A)
Weight / with handle	2.7 / 2.85 kg	2.7 / 2.85 kg	3.7 / 3.85 kg	3.7 / 3.85 kg	3.7 / 3.85 kg
Housing / 3D model ⁷⁾	½ 19", 1 U / PLA_M1	½ 19", 1 U / PLA_M1	½ 19", 2 U / PLI_M6	½ 19", 2 U / PLI_M6	½ 19", 2 U / PLI_M6

Model (order number)	PLA212	PLA212C2	PLA412	PLA412C4	PLA512
Maximum input voltage V _{max}	120 V	120 V	120 V	120 V	120 V
Minimum input voltage V _{min}	1.2 V	1.2 V	1.2 V	1.2 V	1.2 V
Maximum current	15 A	2 A	15 A	4 A	15 A
Continuous power	200 W	200 W	400 W	400 W	500 W
Short-time power ¹⁾	300 W	240 W	500 W	480 W	500 W
Voltage setting	0 ... 120 V	0 ... 120 V	0 ... 120 V	0 ... 120 V	0 ... 120 V
Current setting	0 ... 15 A	0 ... 2 A	0 ... 15 A	0 ... 4 A	0 ... 15 A
Resistance setting	134 mΩ ... 266 Ω	1,0 Ω ... 2000 Ω	134 mΩ ... 266 Ω	500 mΩ ... 1000 Ω	134 mΩ ... 266 Ω
Power setting ²⁾	0 ... 300 W	0 ... 240 W	0 ... 500 W	0 ... 480 W	0 ... 500 W
Rise/fall time ³⁾	40 μs	30 μs	35 μs	30 μs	35 μs
Input capacity ca.	1 μF	1 μF	1 μF	1 μF	1 μF
Load terminals ⁴⁾ rear / front	SBU4-32 / SBU4-32	SBU4-32 / SBU4-32	SBU4-32 / SBU4-32	SBU4-32 / SBU4-32	SBU4-32 / SBU4-32
Power consumption	30 VA	30 VA	37 VA	37 VA	37 VA
Noise max. ⁵⁾	49 dB(A)	49 dB(A)	61 dB(A)	61 dB(A)	61 dB(A)
Weight / with handle	2.7 / 2.85 kg	2.7 / 2.85 kg	3.7 / 3.85 kg	3.7 / 3.85 kg	3.7 / 3.85 kg
Housing / 3D model ⁷⁾	½ 19", 1 U / PLI_M2	½ 19", 1 U / PLI_M2	½ 19", 2 U / PLI_M7	½ 19", 2 U / PLI_M7	½ 19", 2 U / PLI_M7

Model (order number)	PLA230	PLA430	PLA280	PLA480
Maximum input voltage V _{max}	300 V	300 V	800 V	800 V
Minimum input voltage V _{min}	1.2 V	1.2 V	1.2 V	1.2 V
Maximum current	6 A	6 A	3 A	3 A
Continuous power	200 W	400 W	200 W	400 W
Short-time power ¹⁾	200 W	400 W	200 W	400 W
Voltage setting	0 ... 300 V	0 ... 300 V	0 ... 800 V	0 ... 800 V
Current setting	0 ... 6 A	0 ... 6 A	0 ... 3 A	0 ... 3 A
Resistance setting	334 mΩ ... 666 Ω	334 mΩ ... 666 Ω	667 mΩ ... 1333 Ω	667 mΩ ... 1333 Ω
Power setting ²⁾	0 ... 200 W	0 ... 400 W	0 ... 200 W	0 ... 400 W
Rise/fall time ³⁾	35 μs	40 μs	40 μs	30 μs
Input capacity ca.	100 nF	100 nF	50 nF	50 nF
Load terminals ⁴⁾ rear / front	SBU4-32 / SBU4-32	SBU4-32 / SBU4-32	SBU4-32 / SBU4-32	SBU4-32 / SBU4-32
Power consumption	30 VA	37 VA	30 VA	37 VA
Noise max. ⁵⁾	49 dB(A)	61 dB(A)	49 dB(A)	61 dB(A)
Weight / with handle	2.7 / 2.85 kg	3.7 / 3.85 kg	2.7 / 2.85 kg	3.7 / 3.85 kg
Housing / 3D model ⁷⁾	½ 19", 1 U / PLI_M2	½ 19", 2 U / PLI_M7	½ 19", 2 U / PLI_M7	½ 19", 2 U / PLI_M13

1. Minimum voltage for maximum static load current, linear derating to 0 V.

2. Level and duration of the peak power depend on the previous load.

3. The setting range corresponds to the peak power.

4. Rise and fall times are defined of 10 ... 90 % and 90 ... 10 % of the maximum current (constant current mode, FAST, tolerance ±20 %). Rise and fall time at setting „slow“: ca. 500 μs.

5. Description of the available terminals starting at page 109.

6. Measured at the front in 1 m distance.

7. 1 U = 44.45 mm. Detailed dimensions by means of 3D models at www.hoercherl-hackl.com/downloads.

Model (order number)	PLA806	PLA806C16	PLA1006	PLA1206	PLA1206C24	PLA1506
Maximum input voltage V _{max}	60 V	60V	60 V	60 V	60 V	60 V
Minimum input voltage V _{min} ¹⁾	1.2 V	1.2 V	1.2 V	1.2 V	1.2 V	1.2 V
Maximum current	80 A	16 A	80 A	120 A	24 A	120 A
Continuous power	800 W	800 W	1,000 W	1,200 W	1,200 W	1,500 W
Short-time power ²⁾	1,000 W	960 W	1,000 W	1,500 W	1,440 W	1,500 W
Voltage setting	0 ... 60 V	0 ... 60 V	0 ... 60 V	0 ... 60 V	0 ... 60 V	0 ... 60 V
Current setting	0 ... 80 A	0 ... 16 A	0 ... 80 A	0 ... 120 A	0 ... 24 A	0 ... 120 A
Resistance setting	25 mΩ ... 50 Ω	125 mΩ ... 250 Ω	25 mΩ ... 50 Ω	17 mΩ ... 33 Ω	84 mΩ ... 166 Ω	17 mΩ ... 33 Ω
Power setting ³⁾	0 ... 1,000 W	0 ... 960 W	0 ... 1,000 W	0 ... 1,500 W	0 ... 1,440 W	0 ... 1,500 W
Rise/fall time ⁴⁾	50 μs	30 μs	40 μs	40 μs	30 μs	40 μs
Input capacity ca.	2 μF	2 μF	2 μF	3 μF	3 μF	3 μF
Load terminals ⁵⁾ rear / front	FKS20/4-SM8 / FKS20/4-SM8	PK4-30L / PK4-30L	FKS20/4-SM8 / FKS20/4-SM8	FKS20/4-SM8 / FKS20/4-SM8	PK4-30L / PK4-30L	FKS20/4-SM8 / FKS20/4-SM8
Power consumption	55 VA	54 VA	55 VA	70 VA	69 VA	69 VA
Noise max. ⁶⁾	62 dB(A)	62 dB(A)	62 dB(A)	61 dB(A)	61 dB(A)	61 dB(A)
Weight	7.2 kg	7.2 kg	7.2 kg	8.5 kg	8.5 kg	8.5 kg
Housing / 3D model ⁷⁾	19", 2 U / PLI_M10	19", 2 U / PLI_M12	19", 2 U / PLI_M10	19", 2 U / PLI_M10	19", 2 U / PLI_M13	19", 2 U / PLI_M10

Model (order number)	PLA812	PLA812C8	PLA1012	PLA1212	PLA1212C12	PLA1512
Maximum input voltage V _{max}	120 V	120 V	120 V	120 V	120 V	120 V
Minimum input voltage V _{min} ¹⁾	1.2 V	1.2 V	1.2 V	1.2 V	1.2 V	1.2 V
Maximum current	40 A	8 A	40 A	60 A	12 A	60 A
Continuous power	800 W	800 W	1,000 W	1,200 W	1,200 W	1,500 W
Short-time power ²⁾	1,000 W	960 W	1,000 W	1,500 W	1,440 W	1,500 W
Voltage setting	0 ... 120 V	0 ... 120 V	0 ... 120 V	0 ... 120 V	0 ... 120 V	0 ... 120 V
Current setting	0 ... 40 A	0 ... 8 A	0 ... 40 A	0 ... 60 A	0 ... 12 A	0 ... 60 A
Resistance setting	50 mΩ ... 100 Ω	250 mΩ ... 500 Ω	50 mΩ ... 100 Ω	34 mΩ ... 66 Ω	167 mΩ ... 333 Ω	34 mΩ ... 66 Ω
Power setting ³⁾	0 ... 1,000 W	0 ... 960 W	0 ... 1,000 W	0 ... 1,500 W	0 ... 1,440 W	0 ... 1,500 W
Rise/fall time ⁴⁾	35 μs	40 μs	35 μs	40 μs	40 μs	35 μs
Input capacity ca.	2 μF	2 μF	2 μF	3 μF	3 μF	3 μF
Load terminals ⁵⁾ rear / front	BPK4-60L / BPK4- 60L	SBU4-32 / SBU4-32	BPK4-60L / BPK4- 60L	BPK4-60L / BPK4- 60L	SBU4-32 / SBU4-32	BPK4-60L / BPK4- 60L
Power consumption	55 VA	55 VA	54 VA	70 VA	70 VA	69 VA
Noise max. ⁶⁾	62 dB(A)	62 dB(A)	62 dB(A)	61 dB(A)	61 dB(A)	61 dB(A)
Weight	7.2 kg	7 kg	7.2 kg	8.5 kg	8 kg	8.5 kg
Housing / 3D model ⁷⁾	19", 2 U / PLI_M11	19", 2 U / PLI_M13	19", 2 U / PLI_M11	19", 2 U / PLI_M11	19", 2 U / PLI_M13	19", 2 U / PLI_M11

Model (order number)	PLA830	PLA1230	PLA880	PLA1280
Maximum input voltage V _{max}	300 V	300 V	800 V	800 V
Minimum input voltage V _{min} ¹⁾	1.2 V	1.2 V	1.2 V	1.2 V
Maximum current	16 A	24 A	8 A	12 A
Continuous power	800 W	1,200 W	800 W	1,200 W
Short-time power ²⁾	800 W	1,200 W	800 W	1,200 W
Voltage setting	0 ... 300 V	0 ... 300 V	0 ... 800 V	0 ... 800 V
Current setting	0 ... 16 A	0 ... 24 A	0 ... 8 A	0 ... 12 A
Resistance setting	125 mΩ ... 250 Ω	84 mΩ ... 166 Ω	250 mΩ ... 500 Ω	167 mΩ ... 333 Ω
Power setting ³⁾	0 ... 800 W	0 ... 1,200 W	0 ... 800 W	0 ... 1,200 W
Rise/fall time ⁴⁾	40 μs	40 μs	40 μs	40 μs
Input capacity ca.	200 nF	300 nF	100 nF	150 nF
Load terminals ⁵⁾ rear / front	SBU4-32 / SBU4-32	SBU4-32 / SBU4-32	SBU4-32 / SBU4-32	SBU4-32 / SBU4-32
Power consumption	55 VA	70 VA	55 VA	70 VA
Noise max. ⁶⁾	62 dB(A)	61 dB(A)	62 dB(A)	61 dB(A)
Weight	7 kg	8.5 kg	7 kg	8.35 kg
Housing / 3D model ⁷⁾	19", 2 U / PLI_M13	19", 2 U / PLI_M13	19", 2 U / PLI_M13	19", 2 U / PLI_M13

1. Minimum voltage for maximum static load current, linear derating to 0 V.
2. Level and duration of the peak power depend on the previous load.
3. The setting range corresponds to the peak power.
4. Rise and fall times are defined of 10 ... 90 % and 90 ... 10 % of the maximum current (constant current mode, FAST, tolerance ±20 %). Rise and fall time at setting „slow“: ca. 500 μs.
5. Description of the available terminals starting at page 109.
6. Measured at the front in 1 m distance.
7. 1 U = 44.45 mm. Detailed dimensions by means of 3D models at www.hoecherl-hackl.com/downloads.

PLA Series Display Resolution

Model	U display low	U display high	I display low	I display high
PLA206	0 ... 9.99 V	10.0 ... 60.0 V	0 ... 9.99 A	10.0 ... 30.0 A
PLA206C4	0 ... 9.99 V	10.0 ... 60.0 V	0 ... 999 mA	1.00 ... 4.00 A
PLA212	0 ... 99.9 V	100 ... 120 V	0 ... 9.99 A	10.0 ... 15.0 A
PLA212C2	0 ... 99.9 V	100 ... 120 V	0 ... 999 mA	1.00 ... 2.00 A
PLA230	0 ... 99.9 V	100 ... 300 V	0 ... 999 mA	1.00 ... 6.00 A
PLA280	0 ... 99.9 V	100 ... 800 V	0 ... 999 mA	1.00 ... 3.00 A

Model	U display low	U display high	I display low	I display high
PLA406	0 ... 9.99 V	10.0 ... 60.0 V	0 ... 9.99 A	10.0 ... 30.0 A
PLA406C8	0 ... 9.99 V	10.0 ... 60.0 V	0 ... 999 mA	1.00 ... 8.00 A
PLA506	0 ... 9.99 V	10.0 ... 60.0 V	0 ... 9.99 A	10.0 ... 30.0 A
PLA412	0 ... 99.9 V	100 ... 120 V	0 ... 9.99 A	10.0 ... 15.0 A
PLA412C4	0 ... 99.9 V	100 ... 120 V	0 ... 999 mA	1.00 ... 4.00 A
PLA512	0 ... 99.9 V	100 ... 120 V	0 ... 9.99 A	10.0 ... 15.0 A
PLA430	0 ... 99.9 V	100 ... 300 V	0 ... 999 mA	1.00 ... 6.00 A
PLA480	0 ... 99.9 V	100 ... 800 V	0 ... 999 mA	1.00 ... 3.00 A

Model	U display low	U display high	I display low	I display high
PLA806	0 ... 9.99 V	10.0 ... 60.0 V	0 ... 9.99 A	10.0 ... 80.0 A
PLA806C16	0 ... 9.99 V	10.0 ... 60.0 V	0 ... 9.99 A	10.0 ... 16.0 A
PLA1006	0 ... 9.99 V	10.0 ... 60.0 V	0 ... 9.99 A	10.0 ... 80.0 A
PLA812	0 ... 99.9 V	100 ... 120 V	0 ... 9.99 A	10.0 ... 40.0 A
PLA812C8	0 ... 99.9 V	100 ... 120 V	0 ... 999 mA	1.00 ... 8.00 A
PLA1012	0 ... 99.9 V	100 ... 120 V	0 ... 9.99 A	10.0 ... 40.0 A
PLA830	0 ... 99.9 V	100 ... 300 V	0 ... 9.99 A	10.0 ... 16.0 A
PLA880	0 ... 99.9 V	100 ... 800 V	0 ... 999 mA	1.00 ... 8.00 A

Model	U display low	U display high	I display low	I display high
PLA1206	0 ... 9.99 V	10.0 ... 60.0 V	0 ... 99.9 A	100 ... 120 A
PLA1206C24	0 ... 9.99 V	10.0 ... 60.0 V	0 ... 9.99 A	10.0 ... 24.0 A
PLA1506	0 ... 9.99 V	10.0 ... 60.0 V	0 ... 99.9 A	100 ... 120 A
PLA1212	0 ... 99.9 V	100 ... 120 V	0 ... 9.99 A	10.0 ... 60.0 A
PLA1212C12	0 ... 99.9 V	100 ... 120 V	0 ... 9.99 A	10.0 ... 12.0 A
PLA1512	0 ... 99.9 V	100 ... 120 V	0 ... 9.99 A	10.0 ... 60.0 A
PLA1230	0 ... 99.9 V	100 ... 300 V	0 ... 9.99 A	10.0 ... 24.0 A
PLA1280	0 ... 99.9 V	100 ... 800 V	0 ... 9.99 A	10.0 ... 12.0 A

Options (Summary) and Accessories

Order number	Article	Description
52-135-001-22	PLA01	RS-232 + USB + Ethernet interface incl. K-RS-SNM 9-9 (RS-232 cable)
52-200-001-22	PLA02	GPIB interface (up from 400 W devices) PLA01 necessary
52-600-001-22	PLA03	CAN interface (PLA01 necessary)
64-307-000-22	PLA10	19" installation kit for 1 device with ½ 19", 1 U
64-308-000-22	PLA11	19" installation kit for 2 devices with ½ 19", 1 U
64-309-000-22	PLA12	19" installation kit for 1 device with ½ 19", 2 U
64-310-000-22	PLA13	19" installation kit for 2 devices with ½ 19", 2 U
64-311-000-22	PLA14	19" installation kit for 1 device with ½ 19", 2 U and 1 device with ½ 19", 1 U
64-312-000-22	PLA15	19" installation kit for 1 device with ½ 19", 2 U and 2 devices with ½ 19", 1 U
64-406-000-22	PLA16	Handle for 1 device with ½ 19", 1 or 2 U
64-313-000-22	PLA17	19" installation kit for 1 device with 19", 2 U
66-001-000-22	PLA18	12 V DC supply input, reverse polarity protected, 4 mm pole terminals
65-002-000-22	FCC-PLAxx	Factory calibration certificate
64-408-000-22	SAB-PLA-2	Additional safety cover for load terminals for devices with 2 U and copper bars
63-000-001-00	SENSADAPT/4BAN/PH2/60V	Sense adapter from 4 mm banana plugs to Phoenix PH2, max. 60 V
63-000-002-00	SENSADAPT/4BAN/PH2/1200V	Sense adapter from 4 mm banana plugs to Phoenix PH2, max. 1200 V
67-008-020-22	K-MS-PLA+K-MS-CAN	Cable set Master-Slave, consisting of K-MS-PLA and K-MS-CAN (each 2 m)
67-003-020-22	K-MS-PLA	Master-Slave cable I/O Port (2 m)
67-037-020-22	K-MS-CAN	Master-Slave cable CAN (2 m)
49-001-000-22	SX	Modified setting range for PLA series only after consulting H&H
49-002-000-22	SSX	Customized setting range only after consulting H&H
		Load cables see starting at page 113

Operating modes		
Basic operating modes	CC, CV, CR, CP	
Combined operating modes	CC+CV, CP+CV, CR+CV, CP+CC, CR+CC, CV+CC	
Accuracy of setting		
	of setting value	of corresponding range
Voltage	±0.1 %	±0.05 %
Current	±0.2 %	±0.05 %
Resistance (at 5 % to 100 % of voltage range)	±1.4 %	±0.3 % of current range
Power (at V and I > 10 % of range)	±0.7 %	
(at V or I 5 ... 10 % of range)	±2 %	
Resolution	12 bits	
Accuracy of adjustable protections		
	of setting value	of corresponding range
Overcurrent protection	±0.5 %	±0.05 %
Undervoltage protection	±0.3 %	±0.02 %
Resolution	12 bits	
Accuracy of measurement		
	of measured (actual) value	of corresponding range
Voltage	±0.1 %	±0.05 %
Current	±0.2 %	±0.05 %
Resistance	is calculated from voltage and current	
Power	is calculated from voltage and current	
Resolution	16 bits	
Sampling rate	100 µs, not triggerable	
Accuracy of displays (user interface)		
Display user interface	accuracy of each measurement, ±1 digit of the display value	
Resolution	see display resolution page 22	
Dynamic function (LIST)		
Number of load levels	max. 100, with corresponding ramp, dwell and sampling times	
	min.	max.
Dwell time	1 ms	100 s
Ramp time	0 s	100 s
Resolution	1 ms	
Accuracy of setting times	±0.02 %	
Sampling times	1 ms ... 100 s, resolution 1 ms	
Data acquisition		
	of measured (actual) value	of corresponding range
Accuracy voltage	±0.1 %	±0.05 % ±1 LSB
Accuracy current	±0.2 %	±0.05 % ±1 LSB
Resolution	16 bits	
	to internal memory	
Sampling rate	1 ms ... 100 s, 1 ms resolution	
Measurement data	time stamp, voltage, current	
Number of measurement points	max. 100	
Settings memories		
Number of user settings	10, selectable (incl. programmed list)	

I/O port: accuracy of analog control 0 ... 10 V		
	of the setting value	of the corresponding range
Voltage	±0.2 %	±0.05 %
Current	±0.2 %	±0.05 %
	input resistance of analog inputs >10 kΩ	

I/O port: accuracy of analog monitor outputs 0 ... 10 V		
	of analog signal of real value	offset voltage
Voltage	±0.1 %	±15 mV
Current	±0.2 %	±15 mV
	minimum load 2 kΩ	

I/O port: permissible voltages		
Vin-io (GND - neg. load input)	max. 2 V ¹⁾	
VioPE (GND - PE)	max. 125 V ¹⁾	

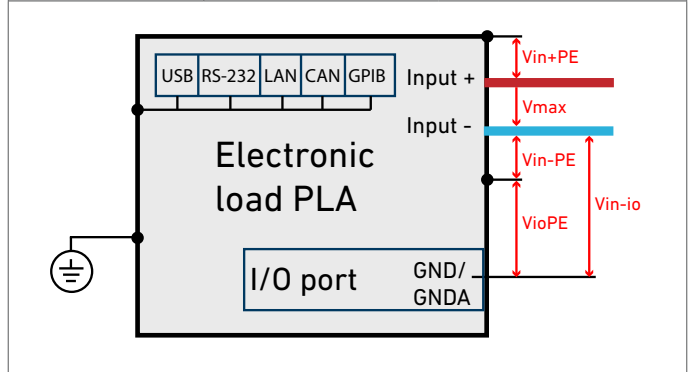

I/O port: outputs and inputs		
Status and control outputs	status load input (on/off, low active) overload (OV, OCP, OPP, OTP, low active)	
Output level	5 V	
Control inputs	load input (on/off, low active) control input (activates I/O port, low active)	
Input level	3 ... 30 V	

Input		
Input resistance	>50 kΩ when load input is off diode function at reverse polarity up to nominal current	
Input capacity	see model overview	
Parallel operation	up to 5 devices in Master-Slave operation	
Maximum input voltage Vmax	see model overview	
Minimum input voltage Vmin	see model overview	

Input: permissible voltages		
Vin-PE (neg. load input - PE)	max. 125 V ¹⁾	
Vin+PE (pos. load input - PE)	Vmax + max. 125 V ¹⁾	

Power		
Continuous power	see model overview (at Ta = 21 °C)	
Derating	-1.2 %/°C for Ta > 21 °C	
Overload capacity	see model overview The possible short-time power depends on the temperature of the device and with that on the normal rating taken before.	

Protection and monitoring		
Protective devices	overcurrent overpower overtemperature	
Monitoring	overvoltage indication reverse polarity indication undervoltage display (if the input voltage is too low for the set current)	

The specified accuracies refer to an ambient temperature of 23 ±5 °C. The specified accuracies are valid when the unit is connected to undisturbed voltages (ripple and noise < 0.1 %). At voltages with higher disturbance values the accuracy can change for the worse.

¹⁾ positive/negative DC voltage or RMS value of a sinusoidal AC voltage

Technical Data (continued)

Terminals	
Load input	see model overview
Sense	at I/O port, only at models up to 160 V
Operating conditions	
Operating temperature	5 ... 40 °C
Stock temperature	-25 ... 65 °C
Max. operating height	2000 m above sea level
Pollution degree	2
Max. humidity	80 % at 31 °C, linear decreasing to 50 % at 40 °C
Min. distance rear panel - wall or other objects	70 cm
Cooling	temperature-controlled air cooling
Noise	see model overview
Mains voltage with option PLA18	1/N/PE AC 85 ... 264 V 50 ... 60 Hz DC 10 ... 18 V
Power consumption	see model overview
Housing	
Color	
Front panel	RAL7035 (light grey)
Rear panel	stainless steel
Side panels, top	RAL7037 (dusty grey)
Dimensions, weight	see model overview
Safety and EMC	
Protection class	1
Protection	IP20
Measuring category	0 (CAT I according to EN 61010:2004)
Electrical safety	DIN EN 61010-1 DIN EN 61010-2-030
EMV, CE marking	DIN EN 55011 DIN EN 61326-1 DIN EN 61000-3-2 DIN EN 61000-3-3
Standard interfaces	
Data interfaces	-
I/O interface	standard I/O port (not isolated)
Available options	
Data interfaces	
PLA01	USB, RS-232, Ethernet
PLA02	GPIO (for models up from 400 W, requires PLA01)
PLA03	CAN (requires PLA01)
Mechanical options	
PLA08	safety cover for copper bars
PLA10	19" installation kit for 1 device with ½ 19"; 1 U
PLA11	19" installation kit for 2 devices with ½ 19"; 1 U
PLA12	19" installation kit for 1 device with ½ 19"; 2 U
PLA13	19" installation kit for 2 devices with ½ 19"; 2 U
PLA14	19" installation kit for 1 device with ½ 19"; 2 U and 1 device with ½ 19"; 1 U
PLA15	19" installation kit for 1 device with ½ 19"; 2 U and 2 devices with ½ 19"; 1 U
PLA16	carrying handle for 1 device with ½ 19"; 1 or 2 U
PLA17	19" installation kit for 1 device with 19"; 2 U
DC-Versorgung	
PLA18	12 V DC supply (10 ... 18 V)
Calibration, warranty	
FCC-PLAxx	Factory Calibration Certificate, twice free of charge
Warranty	2 years