

MEGOHMMETER

C.A 6505



Thank you for purchasing a **C.A. 6505 megohmmeter**.

To obtain the best service from your instrument:

- **read** this user manual carefully,
- **comply with** the precautions for use.



WARNING, risk of DANGER! The operator must refer to this user's manual whenever this danger symbol appears.



Equipment protected by double insulation.



WARNING! Risk of electric shock. The voltage of the parts identified by this symbol may be ≥ 120 V_{DC}. For safety reasons, this symbol is displayed when such a voltage is generated.



Earth.



The CE marking indicates conformity with European directives, in particular LVD and EMC.



The rubbish bin with a line through it indicates that, in the European Union, the product must undergo selective disposal in compliance with Directive WEEE 2002/96/EC. This equipment must not be treated as household waste.

Definition of measurement categories:

- Measurement category IV corresponds to measurements taken at the source of low-voltage installations. Example: power feeders, counters and protection devices.
- Measurement category III corresponds to measurements on building installations. Example: distribution panel, circuit-breakers, machines or fixed industrial devices.
- Measurement category II corresponds to measurements taken on circuits directly connected to low-voltage installations. Example: power supply to electro-domestic devices and portable tools.

PRECAUTIONS FOR USE

This device is compliant with safety standard IEC 61010-2-030 and the leads are compliant with IEC 61010-031, for voltages up to 1000 V with respect to earth in category III.

Failure to observe the safety instructions may result in electric shock, fire, explosion, and destruction of the instrument and of the installations.

- The operator and/or the responsible authority must carefully read and clearly understand the various precautions to be taken in use. Sound knowledge and a keen awareness of electrical hazards are essential when using this instrument.
- If you use this instrument other than as specified, the protection it provides may be compromised, thereby endangering you.
- Do not use the instrument on networks of which the voltage or category exceeds those mentioned.
- Do not use the instrument if it seems to be damaged, incomplete, or poorly closed.
- Before each use, check the condition of the insulation on the leads, housing, and accessories. Any item of which the insulation is deteriorated (even partially) must be set aside for repair or scrapping.
- Use personal protection equipment systematically.
- Use only the accessories delivered with the instrument.
- Respect the value and type of the fuse to avoid damaging the instrument and cancelling the warranty.
- Set the switch to OFF when the instrument is not in use.
- The battery must be charged before metrological tests.
- All troubleshooting and metrological checks must be performed by competent and accredited personnel.

CONTENTS

1. FIRST-TIME USE	4
1.1. Unpacking	4
1.2. Battery charge	4
2. DESCRIPTION	5
2.1. Functions of the instrument	6
2.2. Switch	6
2.3. Keys and button	6
2.4. Display	7
3. MEASUREMENT FUNCTIONS	8
3.1. Voltage measurement	8
3.2. Insulation measurement	8
3.3. Measurement of the PI	10
3.4. Adjustment of the variable test voltage	11
3.5. Adjustment of the maximum test voltage	11
3.6. Error messages	12
4. COMPLEMENTARY FUNCTIONS	13
4.1. Adjustments of the PI	13
4.2. Serial number	13
4.3. Internal software version	14
5. SPECIFICATIONS	15
5.1. Reference conditions	15
5.2. Characteristics per function	15
5.3. Power supply	18
5.4. Construction specifications	18
5.5. Environmental parameters	18
5.6. Compliance with international standards	19
5.7. Variations in operating range	19
6. MAINTENANCE	20
6.1. Servicing	20
6.2. Calibration check	20
6.3. Repair	20
7. WARRANTY	21
8. GLOSSARY	22
9. TO ORDER	23
9.1. Accessories	23
9.2. Replacement parts	23

1. FIRST-TIME USE

1.1. UNPACKING

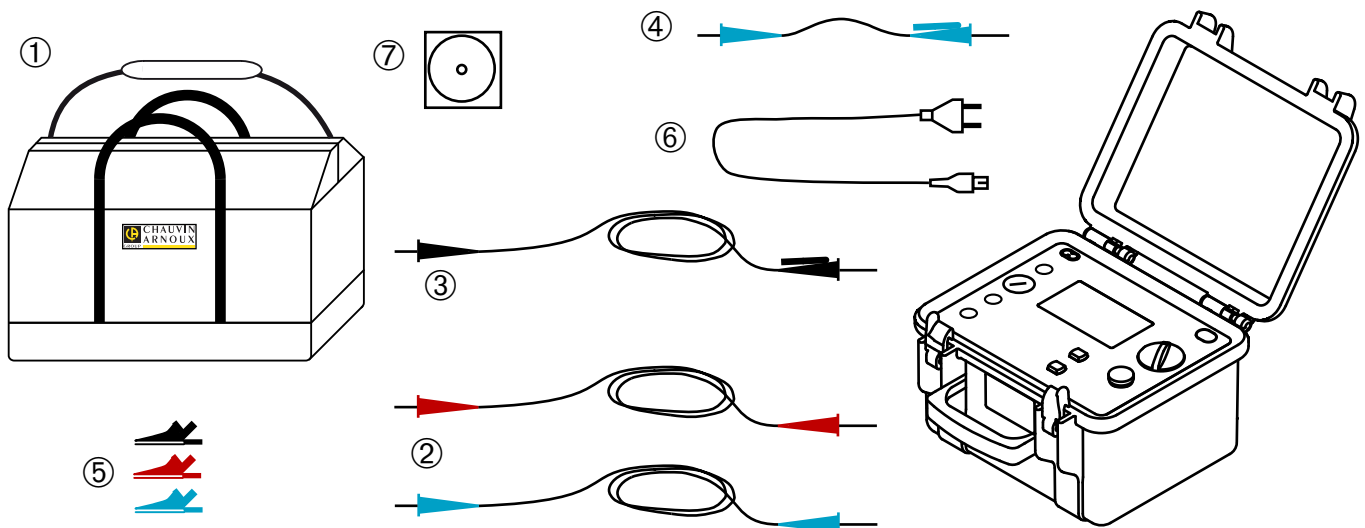

- ① One carrying bag.
- ② Two 2 m safety leads with a high-voltage plug at each end (one red and one blue).
- ③ One 2 m guarded safety lead with a high-voltage plug at one end and a high-voltage plug with rear pick-up jack at the other end (black).
- ④ One 0.35 m guarded safety lead with a high-voltage plug at one end and a high-voltage plug with rear pick-up jack at the other end (blue).
- ⑤ Three alligator clips (red, blue, and black).
- ⑥ One 1.80 m line power cord.
- ⑦ One user manual on CD-ROM (1 file per language).

1.2. BATTERY CHARGE

Before first using, start by fully charging the battery. Charging must be done at between 20 and 30°C.

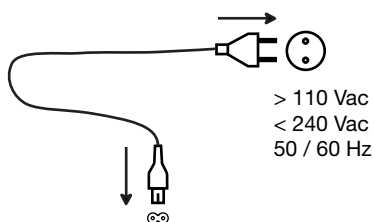

> 110 Vac
< 240 Vac
50 / 60 Hz

Connect the instrument to line power using the power cord.



Charging takes between 6 and 10 hours, depending on the battery's initial charge.



2. DESCRIPTION

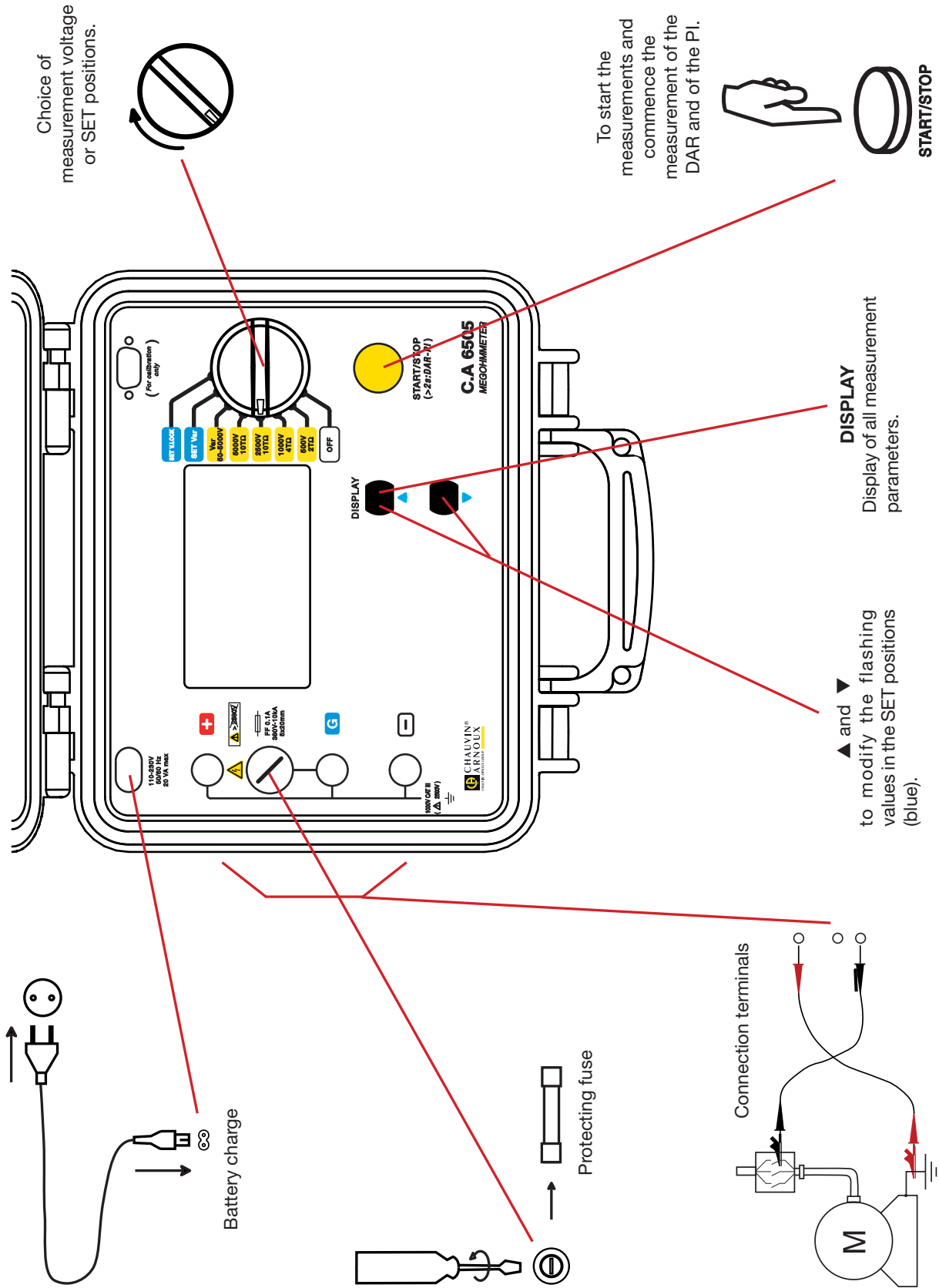

2.1. FUNCTIONS OF THE INSTRUMENT

The C.A 6505 megohmmeter is a portable instrument housed in a rugged field case with lid and operates on either battery or line power. It makes voltage, insulation, and capacitance measurements.

This instrument contributes to the safety of electrical installations and equipment.

It has many advantages, for example:

- automatic voltage measurement,
- automatic detection of the presence of an external AC or DC voltage on the terminals, before or during the measurements, that disables or stops the measurements,
- the simplicity of the user interface,
- calculation of the PI and of the DAR,
- fuse protection of the instrument, with detection of a defective fuse,
- operator safety thanks to the automatic discharging of the device tested,
- automatic power-down of the instrument to extend battery life,
- an indication of the battery charge condition,
- a large backlit LCD display unit with many annunciators for very easy reading.

2.2. SWITCH

The rotary switch has 8 positions:

- OFF instrument powered down.
- 500 V - 2 TΩ insulation measurement at 500 V, up to 2 TΩ.
- 1000 V - 4 TΩ insulation measurement at 1000 V, up to 4 TΩ.
- 2500 V - 10 TΩ insulation measurement at 2500 V, up to 10 TΩ.
- 5000 V - 10 TΩ insulation measurement at 5000 V, up to 10 TΩ.
- Var. 50 - 5000 V insulation measurement with variable test voltage.
- SET Var sets the user definable test voltage for the Var. 50 - 5000 V position.
- SET V.LOCK sets the user definable maximum test voltage output irrespective of the insulation measurement positions.

2.3. KEYS AND BUTTON

START/STOP	This button is pressed to start then stop the measurement. A long press starts the measurement of the DAR and of the PI.
DISPLAY	Before, during or after the measurement, pressing this key displays the various measurement parameters.
▲	This function is available only in the SET positions of the switch. It increments the parameter displayed in flashing mode.
▼	This function is available only in the SET positions of the switch. It decrements the parameter displayed in flashing mode.

Keeping the ▲ and ▼ keys pressed accelerates the rate at which the parameters change.

2.4. DISPLAY

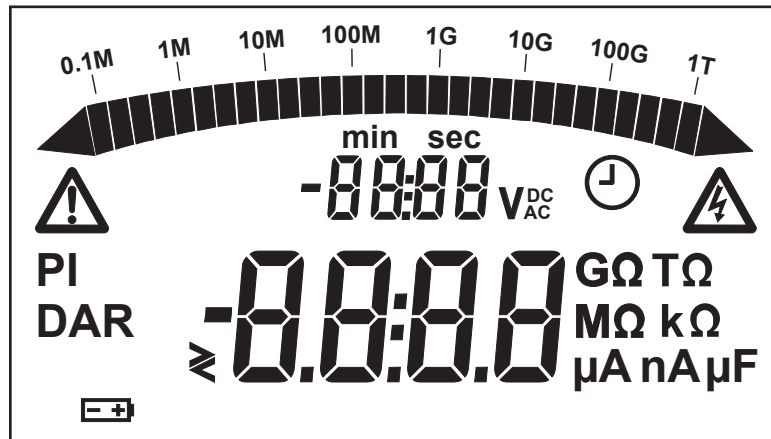

2.4.1. DIGITAL DISPLAY

The main digital display indicates the values for insulation measurement: resistance, DAR PI, DD or capacity.

The small digital display unit indicates the test voltage applied by the instrument or the voltage measured on the object tested. During the insulation measurement, it indicates the elapsed time or the test voltage.

2.4.2. BARGRAPH

The bargraph is active during the insulation measurement (0.1 MΩ to 1 TΩ). It also serves to indicate the condition of the battery.

2.4.3. SYMBOLS

DAR PI Indicates the result of these measurements.



Indicates that the voltage generated is dangerous, $U > 120$ VDC.



Indicates the presence of an external voltage.



Indicates the duration of the measurement, or the time remaining in the case of a PI measurement.



Indicates that the battery is low and must be recharged (see § 1.2).



Indicates a flashing.

3. MEASUREMENT FUNCTIONS

3.1. VOLTAGE MEASUREMENT

As soon as the switch is set to an insulation measurement position, the instrument automatically measures the presence of any AC/DC voltage. This voltage is measured at all times and indicated on the small display unit.

The instrument automatically determines AC or DC: the AC measurement is an RMS value¹.

If an excessively high external voltage is present on the terminals ($> 0.4 U_n$), pressing the START button has no effect and no measurements are made. Similarly, if an excessively high spurious voltage ($> 0.4 U_n$) is detected during the measurement, the measurement is automatically stopped.

3.2. INSULATION MEASUREMENT

Depending on the measurements to be made, there are three ways to connect the instrument.

In all cases, disconnect the device to be tested from the source.

■ Weak insulation

Connect the red high-voltage lead between earth and the + terminal of the instrument.
Connect the black high-voltage lead between one phase of the motor and the - terminal of the instrument.

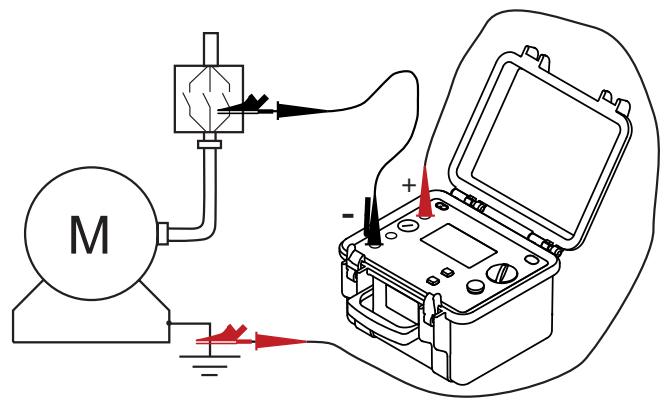

■ Strong insulation

For a very high insulation value, connect the small blue high-voltage lead between the rear earth pick-up jack of the black lead and the G terminal of the instrument.
This serves to reduce any external influence and obtain a more stable measurement.

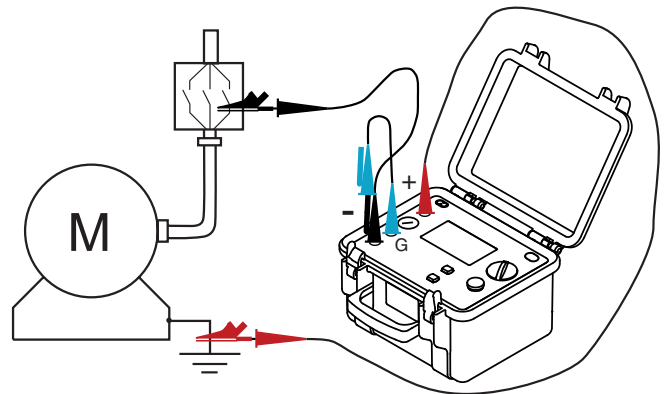

■ Cable

Connect the red high-voltage lead between the braid and the + terminal of the instrument.
Connect the black high-voltage lead between the core and the - terminal of the instrument.
Connect the blue high-voltage lead between the insulation and the G terminal of the instrument.

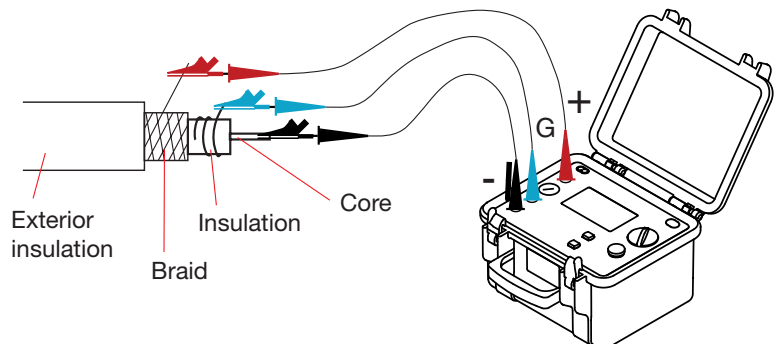

The guard serves to eliminate the effect of surface leakage currents.

¹ : RMS (Root Mean Square): root-mean-square value of the signal, determined by taking the square root of the mean value of the signal squared.

Once the connections have been made, choose the test voltage on the rotary switch.

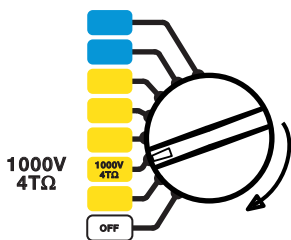

When powered up, the instrument displays the condition of the battery,

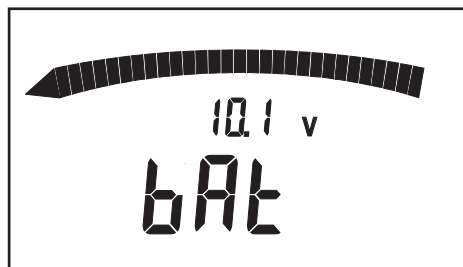

the test voltage,



then the voltage present on the object to be tested.

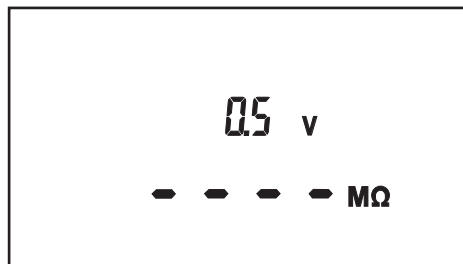

Press the START/STOP key to start the measurement.

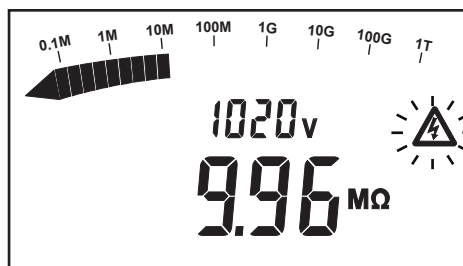

During measurements the instrument will beep every 10 seconds to alert the user that a high voltage is present.

Press the START/STOP key again to stop the measurement. The instrument continues to measure external voltages but the test result remains displayed on the main display unit.

To ensure your safety, the instrument will automatically discharge the circuit under test, allow for the voltage displayed to fall back below 25 V before disconnecting the leads.

Press the DISPLAY key to display:



Before the measurement (2 presses)	the voltage present on the device to be tested, the test voltage, the surface leakage current.
During the measurement (2 presses)	the test voltage, the instantaneous insulation resistance value, the duration of the measurement, the current flowing in the resistance being measured.
After the measurement (5 presses)	the voltage present on the device tested, the insulation resistance value just before the measurement was stopped, the duration of the measurement, the test voltage generated during the measurement, the current that flowed in the resistance measured, the surface leakage current, the capacitance.

3.3. MEASUREMENT OF THE PI

Set the switch to one of the insulation measurement positions.

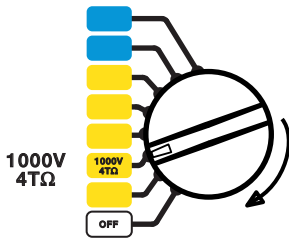

Start the measurement by a long press on the START/STOP key. The long press is acknowledged by an audible beep.

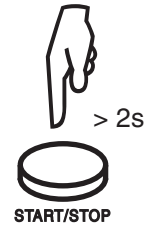

The measurement starts for a duration of 10 min. A countdown displays the time remaining.

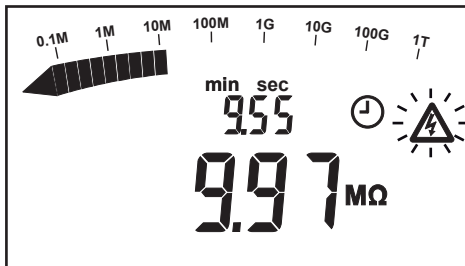

And the measurement stops automatically.



Press the DISPLAY key to display:



Before the measurement (2 presses)	the voltage present on the device to be tested, the test voltage, the leakage current present.
During the measurement (4 presses)	the measurement time remaining, the instantaneous insulation resistance value, the test voltage, the current flowing in the resistance being measured, the value of the PI (available at the end of 10 mn), the value of the DAR (available at the end of one minute).
After the measurement (6 presses)	the test voltage generated during the measurement, the PI, the DAR, the duration of the measurement, the insulation resistance value just before the measurement was stopped, the current that flowed in the resistance measured, the voltage present on the device being tested, the capacitance, the surface leakage current.

The values of PI and DAR are calculated as follows:

$$PI = R_{10 \text{ min}} / R_{1 \text{ min}} \text{ (2 values to be recorded during a measurement lasting 10 mn)}^1$$

$$DAR = R_{1 \text{ min}} / R_{30 \text{ s}} \text{ (2 values to be recorded during a measurement lasting 1 mn)}$$

They are especially useful for monitoring the ageing of the insulation of revolving machines or of very long cables.

On items of this type, the measurement is initially perturbed by spurious currents (capacitive charging current, dielectric absorption current) that gradually cancel out. To measure the leakage current representative of the insulation accurately, it is therefore necessary to make measurements of long duration.

¹ : For the calculation of the PI, the times of 1 and 10 minutes can be modified by the user, if required, for a particular application. See § 4.1.

The quality of the insulation is a function of the results found.

DAR	PI	Condition of the insulation
< 1.25	< 1	Inadequate or even dangerous
	< 2	
< 1.6	< 4	Good
> 1.6	> 4	Excellent

3.4. ADJUSTMENT OF THE VARIABLE TEST VOLTAGE

This function makes it possible to use test voltages other than the 4 available.

Set the switch to SET Var.

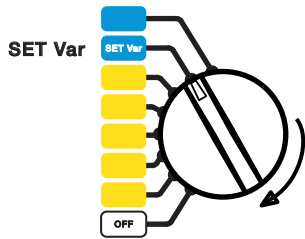

The test voltage flashes.

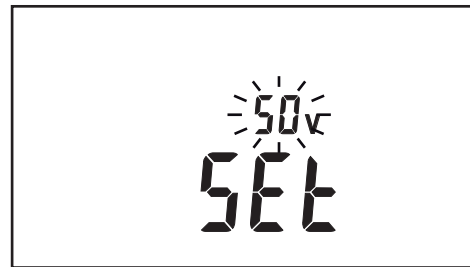

Change it using the ▲ and ▼ keys.

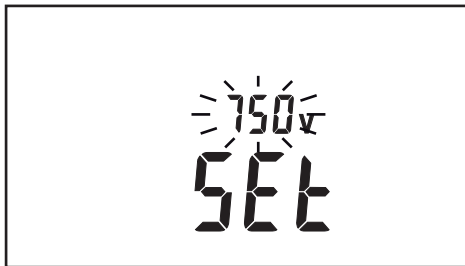

Then set the switch to Var 50 - 5000 V to make the measurement.

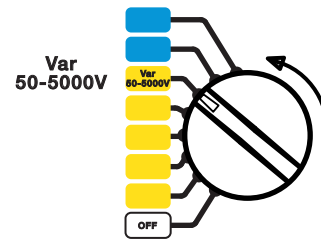

This value is retained in a non-volatile memory.

3.5. ADJUSTMENT OF THE MAXIMUM TEST VOLTAGE

The user can set a maximum generated voltage to prevent any accidental over-voltage tests being conducted in error.

Set the switch to SET V.LOCK.

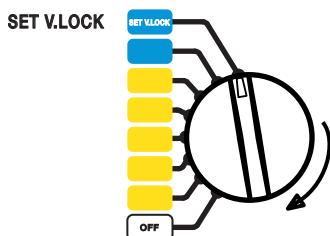

The maximum test voltage flashes.

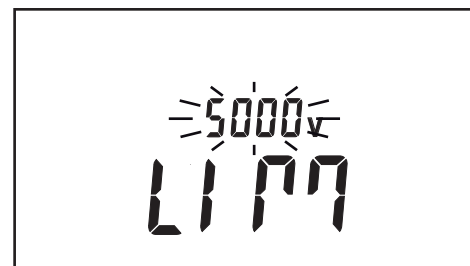

Change it using the ▲ and ▼ keys.

You can then turn the switch to an insulation measurement setting and make measurements.

The maximum test voltage value is retained in a non-volatile memory. It will be displayed for a few seconds on selection of an affected range.

For example, if the maximum voltage is 750 V, it will be applied and displayed on all settings of the switch from 1000 V up.

3.6. ERROR MESSAGES

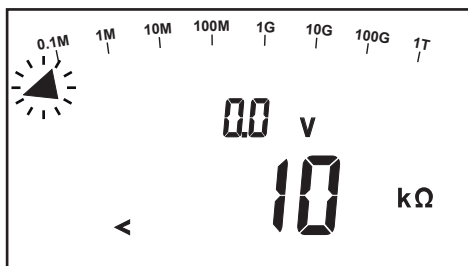

The insulation resistance is too low.

Check your connections, the + and - terminals of the instrument may be short-circuited.

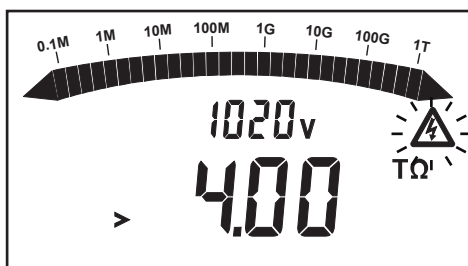

The insulation resistance is outside the measurement range.

Check your connections; one of the terminals of the instrument may be disconnected, or else the value measured is in fact $> 4 T\Omega$.

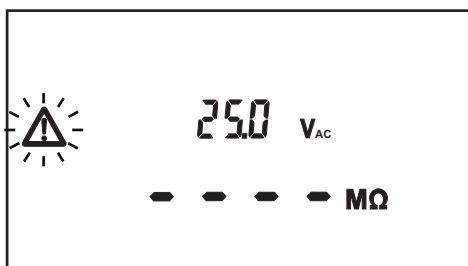

The spurious voltage present on the terminals is greater than 25 VAC or 35 Vpeak.

The instrument alerts you but does not prevent making the measurements.



The spurious voltage present on the terminals is too high for a measurement to be made:

peak spurious V $> 0.4 U_n$
The test voltage, U_n , is indicated by the setting of the switch.

Eliminate the spurious voltage and restart the measurement.

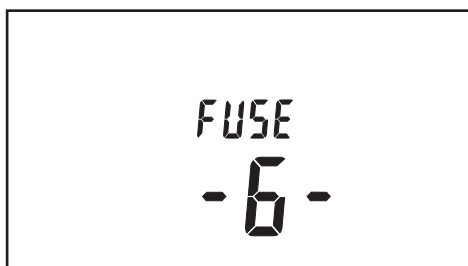

Indicates that the protective fuse of the G terminal is defective.

Replace the fuse as indicated in § 6.1.2.

4. COMPLEMENTARY FUNCTIONS

4.1. ADJUSTMENTS OF THE PI

It is possible to modify the PI times to meet specific needs. This function is not readily accessible because it is not often used.

Reminder: $PI = R_{10 \text{ min}} / R_{1 \text{ min}}$

The first PI time is 1 mn. It can be set to values from 30 s to 30 mn in 30 s steps.

Keep the DISPLAY key pressed and turn the switch to the SET Var position.

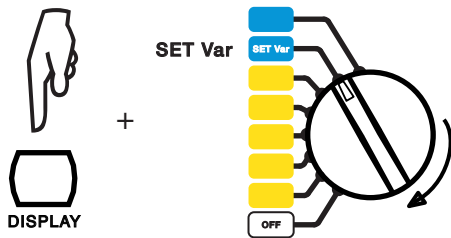

You can change the first PI time (PI_1) using the ▲ and ▼ keys.

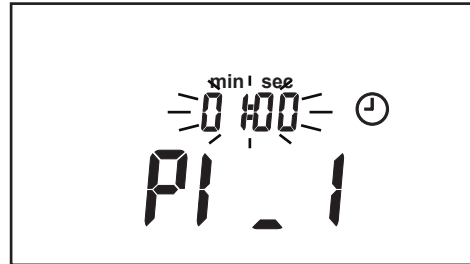

To save changes simply, turn the switch.

The second PI time (PI_2) is 10 min. It can be set to values from PI_1 up to 59 mn in 1 mn steps.

Keep the DISPLAY key pressed and turn the switch to the SET V.LOCK position.

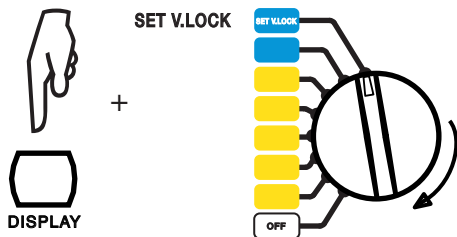

You can modify the second PI time using the ▲ and ▼ keys.

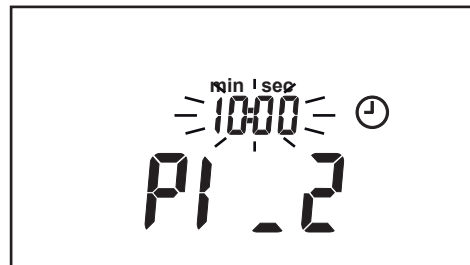

To save changes simply, turn the switch.

4.2. SERIAL NUMBER

To view the serial number of the instrument, keep the DISPLAY key pressed and turn the switch to the 500 V position.

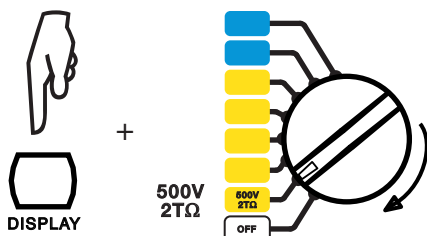

4.3. INTERNAL SOFTWARE VERSION

To view the internal software version of the instrument, keep the DISPLAY key pressed and turn the switch to the 1000 V position.

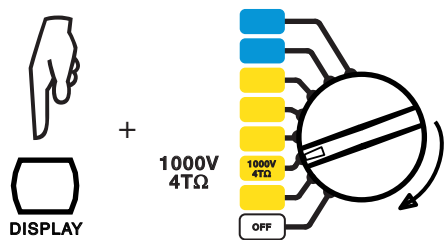

5. SPECIFICATIONS

5.1. REFERENCE CONDITIONS

Influence quantities	Reference values
Temperature	23 ± 3°C
Relative humidity	45 to 55% RH
Supply voltage	9 to 12 V
Frequency range	DC and 15.3...65 Hz
Capacity in parallel on resistor	0 µF
Electrical field	nil
Magnetic field	< 40 A/m

5.2. CHARACTERISTICS PER FUNCTION

5.2.1. VOLTAGE

■ Characteristics

Measurement range	1.0 - 99.9 V	100 - 999 V	1000 - 2500 V	1000 - 5100 V
Frequency range ³	DC and 15 Hz - 500 Hz		15 Hz - 500 Hz	DC
Resolution	0.1 V	1 V	2 V	2 V
Accuracy	1% ± 5 pt		1% ± 1 pt	
Input impedance	750 kΩ at 3 MΩ depending on measured voltage			

3: Over 500 Hz, the small display indicates “- - -” and the main display gives only an assessment of the peak value of the measured voltage.

5.2.2. CURRENT

Current measurement before the insulation measurement:

Measurement range	0.000 - 0.250 nA	0.250 - 9.999 nA	10.00 - 99.99 nA	100.0 - 999.9 nA	1000 - 9.999 µA	10.00 - 99.99 µA	100.0 - 999.9 µA	1000 - 3000 µA
Resolution	1 pA	1 pA	10 pA	100 pA	1 nA	10 nA	100 nA	1 µA
Accuracy	15% ± 10 pt	10%	5%				10%	

Current measurement during the insulation measurement:

Measurement range	0.000 - 0.250 nA	0.250 - 9.999 nA	10.00 - 99.99 nA	100.0 - 999.9 nA	1.000 - 9.999 µA	10.00 - 99.99 µA	100.0 - 999.9 µA	1000 - 3000 µA
Resolution	1 pA	1 pA	10 pA	100 pA	1 nA	10 nA	100 nA	1 µA
Accuracy	15% ± 10 pt	10%	5%	3%				5%

The 0.250 nA and 3000 µA ranges are not used for the insulation resistance calculations.

5.2.3. INSULATION RESISTANCE

- **Method:** Voltage-current measurement as per IEC 61557-2 (Ed. 02/97)
- **Nominal output voltage:** 500, 1000, 2500, 5000 V_{bc} or adjustable from 40 V to 5100 V
- **No-load voltage:** 510, 1020, 2550 and 5100 V ± 2% and U_n ± 2% in variable mode
- **Variable voltage adjustment step:** 10 V from 40 V to 1000 V
100 V from 1000 V to 5100 V
- **Nominal current:** ≥ 1 mA_{bc} at the nominal voltage
- **Short-circuit current:** 1.6 mA ± 5% (3.1 mA max. when the measurement is started)
- **Maximum acceptable spurious voltage during the measurement:** U_{peak} = 0.4 U_n

■ **Accuracy**

Test voltage	500 V - 1000 V - 2500 V - 5000 V			
Specified measurement range	10 - 999 kΩ 1.000 - 3.999 MΩ	4.00 - 39.99 MΩ	40.0 - 399.9 MΩ	0.400 - 3.999 GΩ
Resolution	1 kΩ	10 kΩ	100 kΩ	1 MΩ
Accuracy	±5% + 3 pt			

Test voltage	500 V - 1000 V - 2500 V - 5000 V			1000 V - 2500 V 5000 V	2500 V 5000 V
Specified measurement range	4.00 - 39.99 GΩ	40.0 - 399.9 GΩ	0.400 - 1.999 TΩ	2.000 - 3.999 TΩ	4.00 - 9.99 TΩ
Resolution	10 MΩ	100 MΩ	1 GΩ		10 GΩ
Accuracy	± 5% + 3 pt			±1 5% + 10 pt	

■ **Accuracy in variable mode**

$$R_{\text{measured}} = U_n / 250 \text{ pA}$$

Test voltage	40 - 160 V	170 - 510 V	520 - 1500 V	1600 - 5100 V
R _{measured} min	10 kΩ	10 kΩ	10 kΩ	10 kΩ
R _{measured} max	160.0 GΩ - 640.0 GΩ	640.0 GΩ - 2.040 TΩ	2.080 TΩ - 6.000 TΩ	6.400 TΩ - 10.00 TΩ

To obtain the accuracy in variable voltage mode, calculate from the accuracies of the fixed voltages above.

■ **Measurement of DC voltage during insulation test**

Specified measurement range	40.0 - 99.9 V	100 - 1500 V	1501 - 5100 V
Resolution	0.1 V	1 V	2 V
Accuracy	1% ± 1 pt		

■ **Measurement of the test voltage after a capacitive insulation measurement**

Specified measurement range	25 - 5000 V
Resolution	0.2% U _n or 1 pt
Accuracy	5% ± 3 pt

■ **Calculation of terms DAR and PI**

Specified range	0.02 - 50.00
Resolution	0.01
Accuracy	5% ± 1 pt

■ Typical change curve for test voltages according to load

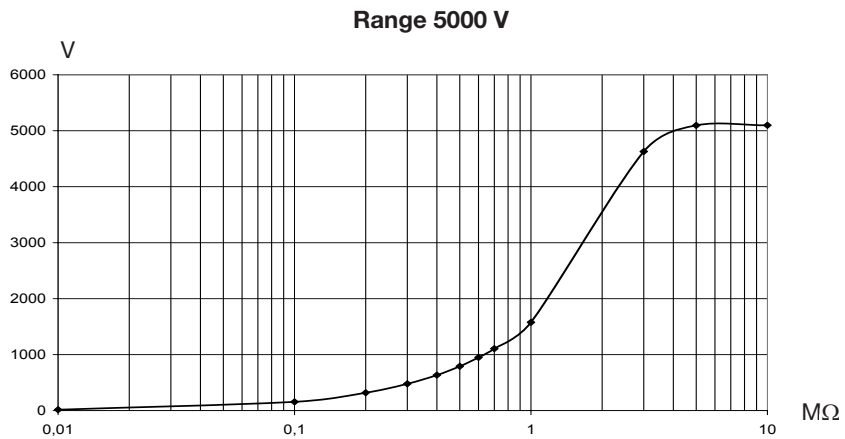
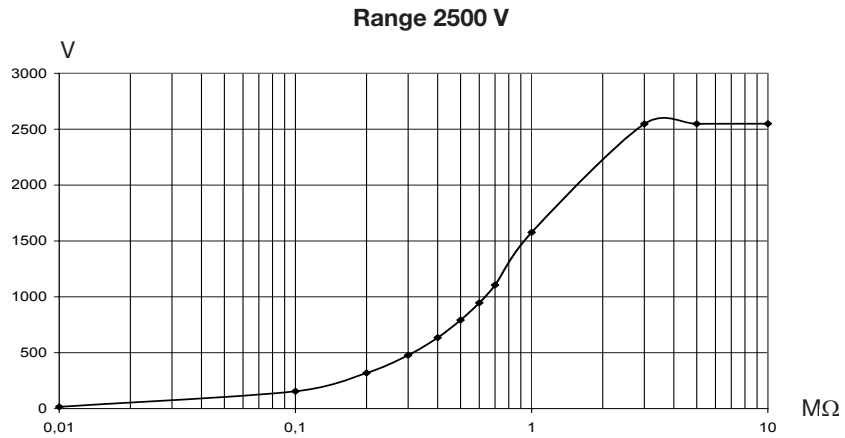
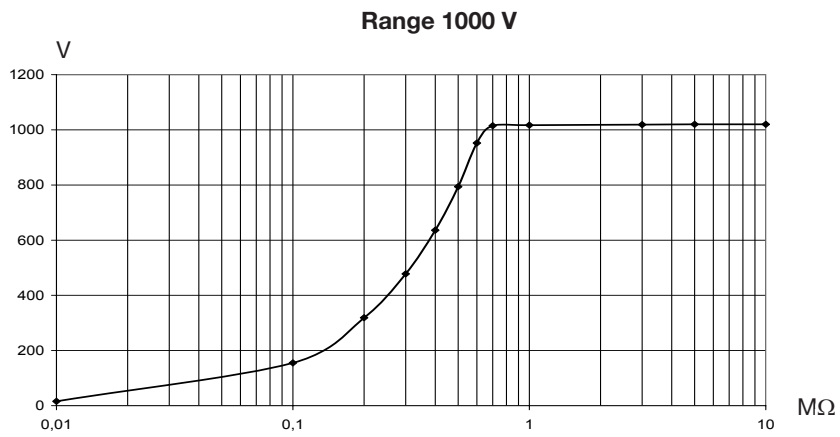
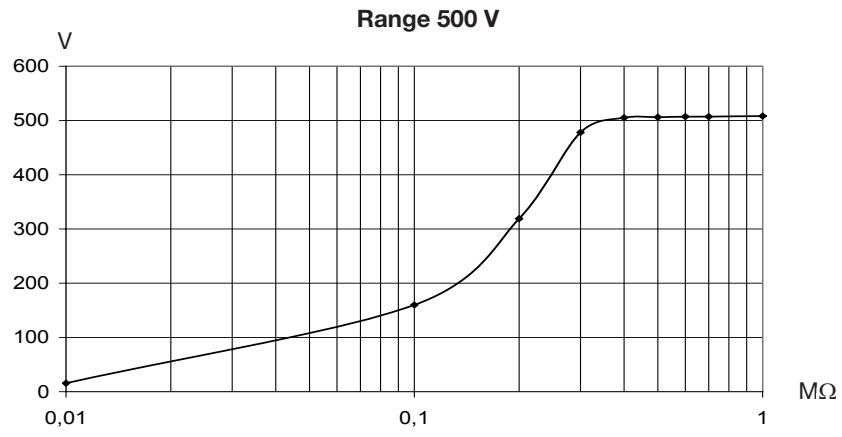

5.2.4. CAPACITANCE

This measurement is made at the end of each insulation measurement, while the circuit is being discharged.

Specified measurement range	0.001 - 9.999 μ F	10.00 - 49.99 μ F
Resolution	1 nF	10 nF
Accuracy	10% \pm 1 pt	10%

5.3. POWER SUPPLY

■ The equipment power supply is obtained from:

Rechargeable NiMh batteries - 8 x 1.2 V / 3.5 Ah
Line voltage: 85 to 256 V / 50-60 Hz

■ Consumption

For insulation measurements at 5000 V and 1 mA: 11 W
For voltage measurements: 0.9 W
On standby: 0.01 W

■ Minimum operating time (per IEC 61557)

Test voltage	500 V	1000 V	2500 V	5000 V
Nominal load	500 k Ω	1 M Ω	2.5 M Ω	5 M Ω
Number of measurements (with 25 s pause between each measurement)	6500	5500	4000	1500

In voltage measurement mode, the battery life is 35 hours.

■ Recharge time

Charging must be done between 20 and 30°C.
6 hours to recover 100% capacity (10 hours if the battery is completely run down).
0.5 hours to recover 10% capacity (charge life: 2 days approximately)

It is essential to charge the battery before calibration tests.

Note: It is possible to recharge the batteries while performing insulation measurements provided that the values measured are higher than 20 M Ω . In this case, the recharging time is higher than 6 hours. Otherwise, the battery is discharged faster than it is charged.

5.4. CONSTRUCTION SPECIFICATIONS

Overall dimensions of the unit (L x l x h): 270 x 250 x 180 mm
Weight: approximately 4.3 kg

5.5. ENVIRONMENTAL PARAMETERS

■ Range of use

-10°C to 40°C, during battery recharging
-10°C to 55°C, during measurement
20% to 80% RH

■ Storage

-40 at 70°C, from 10% to 90% RH

■ Altitude: < 2000 m

■ Use indoors or outdoors.

Diagram of climatic conditions:

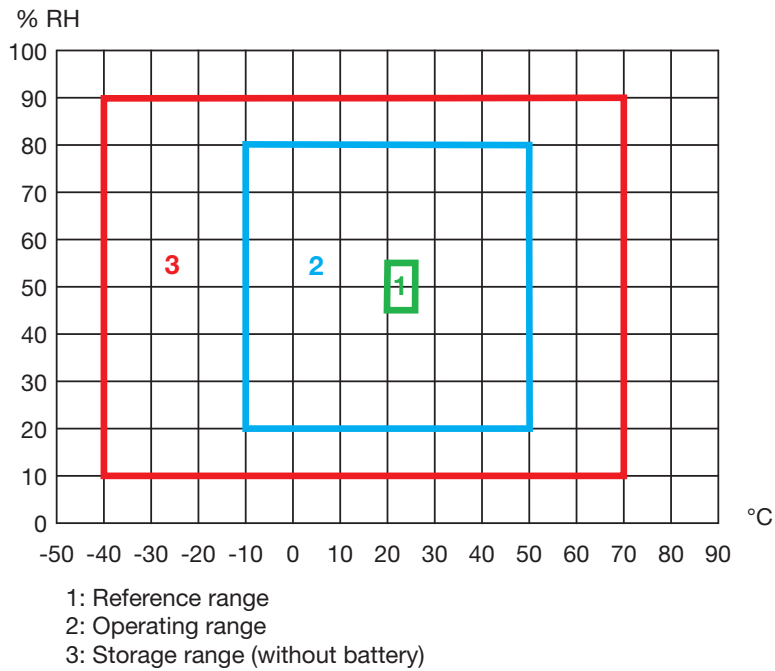

5.6. COMPLIANCE WITH INTERNATIONAL STANDARDS

- Electrical safety as per: IEC 61010-1 and IEC 61557
- Double insulation
- Pollution level: 2
- Measurement category: III
- Max. voltage relative to earth: 1000 V (2500 V in measurement category I)

5.6.1. ELECTROMAGNETIC COMPATIBILITY

Emissions and immunity in an industrial setting compliant with EN 61326-1.

5.6.2. MECHANICAL PROTECTION

IP 53 per IEC 60529
 IK 04 per IEC 50102

5.7. VARIATIONS IN OPERATING RANGE

Influential quantity	Range of influence	Quantity influenced ⁴	Influence	
			Typical	Maximum
Battery voltage	9 V - 12 V	V MΩ	< 1 pt < 1 pt	2 pt 3 pt
Temperature	-10°C +55°C	V MΩ	0.15% /10°C 0.20% /10°C	0.3% /10°C +1 pt 1% /10°C + 2 pt
Humidity	20% - 80% HR	V MΩ (10 kΩ to 40 GΩ) MΩ (40 GΩ to 10 TΩ)	0.2% 0.2% 0.3%	1% +2 pt 1% +5 pt 15% +5 pt
Frequency	15 - 500 Hz	V	3%	0.5% +1 pt
AC voltage superimposed on the Test voltage	0% Un - 20% Un	MΩ	0.1% / % Un	0.5% / % Un +5 pt



4: The terms DAR and PI and the capacitance and current leak measurements are included in the quantity "MΩ".

6. MAINTENANCE

 Except for the fuse, the instrument contains no parts that can be replaced by personnel who have not been specially trained and accredited. Any unauthorized repair or replacement of a part by an “equivalent” may gravely impair safety.

6.1. SERVICING

6.1.1. BATTERY RECHARGE

If the  symbol is displayed, the battery must be recharged. Connect the instrument to line power using the mains lead; it starts charging automatically and the  symbol flashes:

- **bAt** on the small display unit and **chrG** on the main display unit means fast charging in progress.
- **bAt** on the small display unit and **chrG** flashing on the main display unit means that slow charging is in progress
- **bAt** on the small display unit and **FULL** on the main display unit means that charging is over.

 The battery must be replaced by Manumasure or by a repairer approved by CHAUVIN ARNOUX.

6.1.2. REPLACEMENT OF THE FUSE

If **FUSE -G-** appears on the display. Ensure the instrument is disconnected from any source (both test leads and mains lead) the instrument is switched off and replace the fuse located on the front panel.

 For your safety, replace a defective fuse with only a fuse having strictly identical characteristics:
Exact type of fuse (entered on the label on the front panel): FF - 0.1 A - 380 V - 5 x 20 mm - 10 kA.

Note: This fuse is in series with a 0.5 A / 3 kV internal fuse active only in case of major fault in the unit. If after changing the fuse on the front panel, the display still indicates **FUSE - G -**, the unit must be returned for servicing (see § 6.3)

6.1.3. CLEANING

Disconnect the unit completely and turn the rotary switch to OFF.

Use a soft cloth, dampened with soapy water. Rinse with a damp cloth and dry rapidly with a dry cloth or forced air. Do not use alcohol, solvents, or hydrocarbons.

6.1.4. STORAGE

If the instrument has been left unused for an extended period (more than two months), fully charge the battery before using.

6.2. CALIBRATION CHECK

 Like all measuring or testing devices, regular instrument verification is necessary.

This instrument should be checked at least once a year. For checks and calibrations, contact one of our accredited metrology laboratories (information and contact details available on request), at our Chauvin Arnoux subsidiary or the branch in your country.

6.3. REPAIR

For all repairs before or after expiry of warranty, please return the device to your distributor.

7. WARRANTY

Except as otherwise stated, our warranty is valid for **twelve months** starting from the date on which the equipment was sold. Extract from our General Conditions of Sale provided on request.

The warranty does not apply in the following cases:

- inappropriate use of the equipment or use with incompatible equipment;
- modifications made to the equipment without the explicit permission of the manufacturer's technical staff;
- work done on the device by a person not approved by the manufacturer;
- adaptation to a particular application not anticipated in the definition of the equipment or not indicated in the user manual;
- damage caused by shocks, falls, or floods.

8. GLOSSARY

This glossary lists the terms and abbreviations used in this document and on the digital display unit of the instrument.

bAt	Battery charge condition
DAR	Dielectric Absorption Ratio. $DAR = R_{1 \text{ min}} / R_{30 \text{ s}}$
LIM	Maximum test voltage that will be applied during the measurement
PI	Polarisation Index. $PI = R_{10 \text{ min}} / R_{1 \text{ min}}$
Pdn	Power Down (standby)
tEst	Test voltage that will be applied during the measurement
Un	Nominal test voltage

9. TO ORDER

C.A 6505 Megohmmeter P01139704

Delivered with a carrying bag containing:

- Two 2 m safety leads with a HV plug at each end (one red and one blue).
- One 2 m guarded safety lead with a HV plug at one end and a HV plug with a rear pick-up jack at the other end (black).
- One 0.35 m guarded safety lead with a HV plug at one end and a HV plug with a rear pick-up jack at the other end (blue).
- Three alligator clips (red, blue and black)
- 1.80-m mains power lead
- One user manuals on CD-ROM (1 file per language).

9.1. ACCESSORIES

3 HV cable (red + blue + guarded black) 3 m long P01295220
Blue HV lead with alligator clip, 8 m long P01295214
Red HV lead with alligator clip, 8 m long P01295215
Black HV lead with alligator clip and earth pick-up jack, 8 m long P01295216
Blue HV lead with alligator clip, 15 m long P01295217
Red HV lead with alligator clip, 15 m long P01295218
Black HV lead with alligator clip and earth pick-up jack, 15 m long P01295219

9.2. REPLACEMENT PARTS

Set of 2 HV cables with safety connectors \varnothing 4 mm (red/ guarded black) 3 m P01295231
HV cable with safety connector \varnothing 4 mm (blue) 3 m + alligator clip (blue) P01295232
Set of 2 alligator clips (red/black) P01102052Z
Set of 2 test prods (red/black) P01102051Z
HV cable with safety connector \varnothing 4 mm (blue) 3 m + alligator clip (blue) P01295232
0.35 m rear pick up lead P01295221
Standard carrying bag P01298066
Fuse FF 0.1 A - 380 V - 5 x 20 mm - 10 kA (batch of 10) P03297514
Battery 9.6 V - 3.5 AH - NiMh P01296021
Mains power supply cable 2P P01295174



02 - 2015

Code 692056B02 - Ed. 2

DEUTSCHLAND - Chauvin Arnoux GmbH

Ohmstraße1 - 77694 Kehl / Rhein
Tel: (07851) 99 26-0 - Fax: (07851) 99 26-60

UNITED KINGDOM - Chauvin Arnoux Ltd

Unit 1 Nelson Ct - Flagship Sq - Shaw Cross Business Pk
Dewsbury, West Yorkshire - WF12 7TH
Tel: 01924 460 494 - Fax: 01924 455 328

ITALIA - Amra SpA

Via Sant'Ambrogio, 23/25 - 20846 Macherio (MB)
Tel: 039 245 75 45 - Fax: 039 481 561

ÖSTERREICH - Chauvin Arnoux Ges.m.b.H

Slamastrasse 29/2/4 - 1230 Wien
Tel: 01 61 61 9 61-0 - Fax: 01 61 61 9 61-61

SCANDINAVIA - CA Mätssystem AB

Sjöflygvägen 35 - SE 18304 TÄBY
Tel: +46 8 50 52 68 00 - Fax: +46 8 50 52 68 10

SCHWEIZ - Chauvin Arnoux AG

Moosacherstrasse 15 - 8804 AU / ZH
Tel: 044 727 75 55 - Fax: 044 727 75 56

中国 - 上海浦江埃纳迪斯仪表有限公司

上海市虹口区祥德路381号3号楼3楼
Tel: +86 21 65 21 51 96 - Fax: +86 21 65 21 61 07

ESPAÑA - Chauvin Arnoux Ibérica S.A.

C/ Roger de Flor, 293 - 1a Planta - 08025 Barcelona
Tel: 90 220 22 26 - Fax: 93 459 14 43

MIDDLE EAST - Chauvin Arnoux Middle East

P.O. BOX 60-154 - 1241 2020 JAL EL DIB (Beirut) - LEBANON
Tel: (01) 890 425 - Fax: (01) 890 424

USA - Chauvin Arnoux Inc - d.b.a AEMC Instruments

200 Foxborough Blvd. - Foxborough - MA 02035
Tel: (508) 698-2115 - Fax: (508) 698-2118

<http://www.chauvin-arnoux.com>

190, rue Championnet - 75876 PARIS Cedex 18 - FRANCE

Tél. : +33 1 44 85 44 85 - Fax : +33 1 46 27 73 89 - info@chauvin-arnoux.fr

Export : Tél. : +33 1 44 85 44 38 - Fax : +33 1 46 27 95 59 - export@chauvin-arnoux.fr