

KONSTANTER SPL Series Programmable DC Electronic Load

3-349-702-03
2/11.14

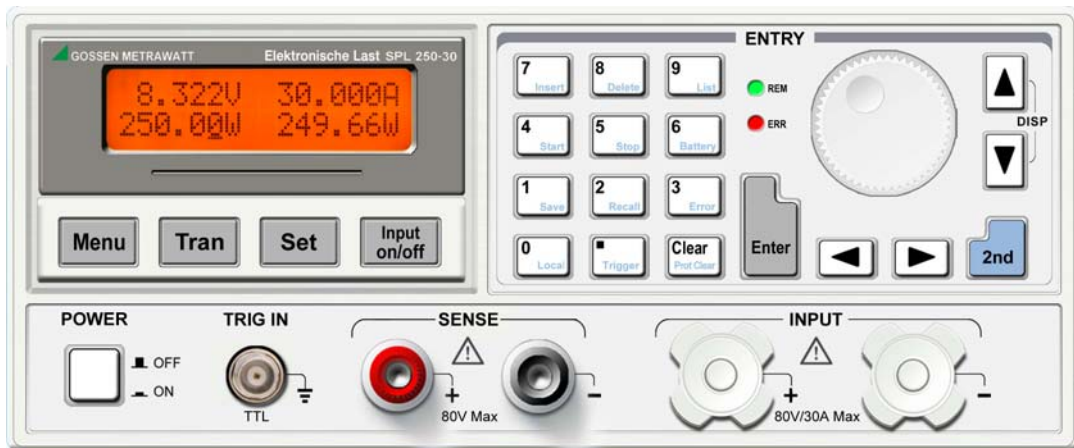

Safety Instructions 3

1	General Introduction	4
1.1	Function Features	4
1.2	Front Panel	5
1.3	Rear Panel	5
1.4	Keypad Function	5
1.5	Displays	6
1.6	Menus	7
1.6.1	Main Menu	7
1.6.2	Mode Selection and Parameter Setting Menu	7
1.6.3	Transient Operation Menu	8
1.6.4	List Operation Menu	8
1.7	Display Messages	9
1.8	Remote Programming	11
2	Functions and Features	12
2.1	Front Panel Operation („Local“) and Remote Control Operation	12
2.2	Programmable Functions	12
2.3	Basic Test Functions	12
2.3.1	Constant Current Mode (CC)	13
2.3.2	Constant Voltage Mode (CV)	14
2.3.3	Constant Resistance Mode (CR)	15
2.3.4	Constant Power Mode (CP)	16
2.4	Transient Operation	17
2.4.1	Continuous Transient Operation	17
2.4.2	Pulsed Transient Operation	18
2.4.3	Toggled Transient Mode	20
2.5	List Operation	21
2.6	Battery Discharge Operation	22
2.7	Short Circuit Operation	22
2.8	Triggered Operation	23
2.9	Input Control	24
2.9.1	Turning On/Off the Load	24
2.9.2	Von Point / Von Latch	24
2.9.3	Current Limit in CV Mode	25
2.9.4	Current Rise Rate	25
2.9.5	Current Fall Rate	25
2.10	Measurement Function	26
2.11	Saving and Recalling	26
2.12	Reading Remote Programming Errors	26
2.13	Status Report	27
2.14	Protection Function	27
2.14.1	Clearing Latched Protection	27
2.14.2	Overvoltage	27
2.14.3	Overcurrent	27
2.14.4	Overpower	27
2.14.5	Overtemperature	27
2.14.6	Reverse Voltage	27
2.15	Auxiliary Functions	28
2.15.1	Trigger Function Selection	28
2.15.2	Knob Function	28
2.15.3	Key Sound	28
3	Installation	28
3.1	Initial Check	28
3.2	Environment/Installation Location	28
3.3	Power-On/ Self-Test	28
3.4	Connections on the Rear Panel	29
3.5	Connections on the Front Panel	30
3.6	Wiring	30
4	Local Operation	31
4.1	Local Control	31
4.2	Main Operation on the Front Panel	31
4.3	Connecting to the Power Supply	31
4.4	Turning the Input On/Off	31

4.5	Basic Operation	31
4.5.1	CC Mode	32
4.5.2	CV Mode	33
4.5.3	CR Mode	34
4.5.4	CP Mode	35
4.6	Short Circuit Operation	36
4.7	Transient Operation	37
4.7.1	Continuous Transient Operation	37
4.7.2	Pulsed Transient Operation	38
4.7.3	Toggled Transient Operation	39
4.8	Sequence Operation (List)	40
4.8.1	Sequence (List) editing	41
4.8.2	Modifying, Adding, Inserting, Deleting Sequences	42
4.8.3	Starting/Stopping the List	43
4.9	Battery Discharge Operation	43
4.10	Saving and Recalling	44
4.11	Clearing Protection Settings	45
4.12	Error Messages	45
4.13	Triggered Operation	46
4.14	Main Menu	46
4.14.1	Loading Default Values	46
4.14.2	Short Circuit Operation	47
4.14.3	Von Point/Von Latch	47
4.14.4	Current Limit in CV Mode	48
4.14.5	Current Rise/Fall Rate in CC Mode	48
4.14.6	Trigger Function Selection	49
4.14.7	Knob Function	49
4.14.8	Key Sound	49
4.14.9	Communication Interface	49
5	Remote Programming Operation	50
5.1	Communication Interface	50
5.1.1	RS232	50
5.1.2	GPIO	50
5.2	Flow Control Selection	50
5.3	Remote Control Indicator	50
5.4	Sending a Remote Command	50
5.5	Returning Data	50
5.6	Remote Programming Commands	50
5.6.1	Modes	50
5.6.2	Transient Levels	50
5.6.3	Programmable Current Protection	51
5.7	CC Mode Examples	51
5.8	CV Mode Examples	51
5.9	CR Mode Examples	51
5.10	Continuous Transient Operation Example	51
5.11	Pulsed Transient Operation Example	52
6	Specifications	53
7	Repair and Replacement Parts Service	56
8	Product Support	56

Safety Instructions



Attention!

These operating instructions include all necessary safety precautions for personal safety, as well as for preventing damage to the power supply and any devices connected to it.

The following general safety precautions must always be adhered to during operation, maintenance and repair of the device. Non-compliance with these safety precautions, or with other explicit warnings included in these operating instructions, is deemed a violation of design-specific safety standards and use for intended purpose. The manufacturer assumes no liability in the event of noncompliance with these safety precautions.

Safety Precautions

- 1 The device may only be operated in accordance with the procedures included in these operation instructions.
- 2 High-voltage conducting components are located inside the device, which may not be contacted directly.
- 3 Read the operating instructions carefully before placing the instrument into service, in order to assure your own safety.
- 4 The device must be grounded.
The device is equipped with a protective earth terminal. The device chassis and the housing must be grounded in order to eliminate the danger of electrical shock. The device may only be connected to mains power by means of a 3 conductor cable, and the protective conductor must be securely connected to the protective conductor terminal of the mains outlet.
- 5 Keep away from voltage conducting electrical circuits!
Operating personnel may not remove any of the device's covers. Only trained personnel are permitted to replace components and change internal settings. Components may not be touched as long as the power cable is connected.
Dangerous voltage may be present even after the power cable has been disconnected from the mains. The device must be disconnected from the mains, electrical circuits must be discharged and external voltage sources must be disconnected before touching any components, in order to prevent personal injury.
The device may not be modified, and only original replacement parts may be used.
In order to assure uninterrupted functionality of the device's safety features, it may only be maintained and/or repaired by qualified service providers.

Connecting the Power Cable

- 1 Examine the voltage selector switch on the back of the device in order to assure that the selected voltage coincides with available mains power. If this is not the case, observe the note printed on the device's mains inlet plug, and make sure that the correct fuse is utilized.
- 2 The on/off switch in the device's front panel must be switched off before the power supply is connected to the mains.
- 3 Connect the 3 conductor cable with plug to the mains outlet. The device must be connected to the protective earth conductor.
- 4 Press the switch on the front panel in order to turn the device on. The device is now ready for operation.

Fuse

The fuse is located in proximity to the mains power inlet plug on the back of the device.

Observe the following points if input voltage is changed and/or the fuse is replaced:

- 1 The on/off switch must be turned off and the power supply must be disconnected from all other devices before changing input voltage and/or replacing the fuse.
- 2 Press the fuse holder with a screwdriver and the fuse pops out.
- 3 Pull the fuse out and replace it with a new fuse which complies with the specifications on the label next to the mains power inlet plug.



Attention!

Use approved fuse types only in order to prevent damage to the device.

- 4 If input voltage needs to be changed, replace the fuse as described above and then set the voltage selector switch to the desired position (230 V AC or 115 V AC). The selected input voltage appears at the selector switch.

Power Supply Output Terminals

- 1 For reasons of safety, make sure that there are no short-circuits between the positive and negative terminals. The device is equipped with short-circuit protection, but a short-circuit may result in injury to the user.
- 2 The output cable must be insulated all the way up to the connected power consumer.



Attention!

It is imperative that the hazard notes be strictly observed!

- 3 The electronic load is equipped with heavy current screw terminals of protection type IP00 for connection to power sources.
- 4 The electronic load may be connected with DC current sources up to a voltage of :
SPL 250-30 as well as SPL 400-40: max. 84 V DC
SPL 200-20 as well as SPL 350-30: max. 210 V DC

If the load is connected with a voltage greater than the standardized safety-low voltage, the user must take care to ensure that a sufficiently safe cover against accidental contact is provided.

1 General Introduction

SPL Series programmable electronic load, a new product generation by GOSSEN METRAWATT, is designed for high performance. It provides you with powerful test functions and user-friendly HMI, RS232, GPIB interfaces to support SCPI and Labview. Electronic loads of the SPL series are widely used in scientific research and production fields such as aerospace, shipbuilding, automotive electronics, solar cell, and fuel cell.

All "electronic load" and "load" which appear in this manual refer to SPL Series Electronic Load by GOSSEN METRAWATT if there is no special explanation.

1.1 Function Features

- 4 basic test functions: CC, CV, CR, and CP; 8 basic operating modes: CCL, CCH, CV, CRL, CRM, CRH, CPV, CPC;
- The 24 bits A/D and 17 bits D/A converters incorporated, provide this equipment with greatly enhanced setting and measurement resolution. 100kHz D/A conversion rate fully improves high-speed performance;
- Minimum operating voltage is less than 0.6 V (80 V-Loads) or 1,2 V (200 V-Loads) at the load's full rated current.
- Perfect protection assures high reliability in the most complicated test environments;
- Innovative design of CPV and CPC modes effectively improves the practicability of CP mode;
- Circuit improvement greatly enhances the dynamic response of CR mode and widens the application scope of that mode;
- High-speed transient operation with separate setting options for high and low level, rise and fall time.
- Powerful sequential test function; with a minimum step time of 10 μ s; and a maximum step time of 10000 s. Cyclic numbers can be adjusted freely and a sequence can be chained to another sequence to achieve even more complex test procedures;
- The input binding posts with their innovative design are especially suitable for large current testing;
- Provides short-circuit test, battery discharge test and other auxiliary functions;
- A high-efficiency, intelligent cooling system can effectively reduce system temperature and enhance power density
- Automatic ON/OFF function simplifies test operation;
- Knobs and digital keypad makes the operation more convenient;
- Save/recall function can save multiple groups of general settings;
- Supports SCPI (Standard Commands for Programmable Instrumentation) and Labview, and provides necessary PC software.

1.2 Front Panel

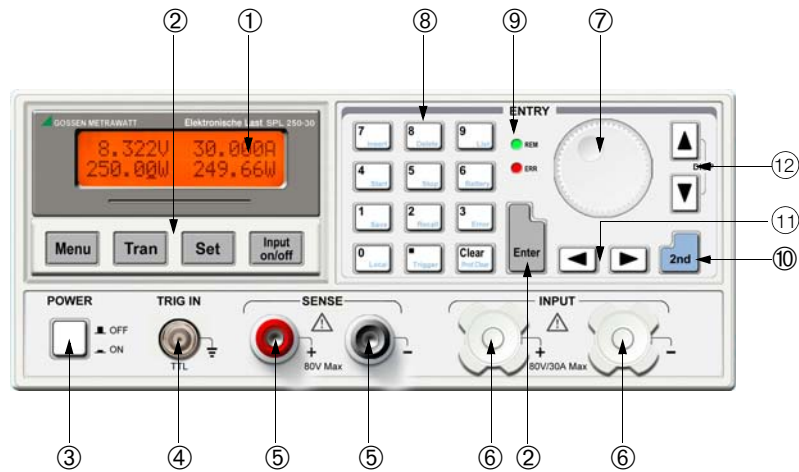

Figure 1.1 Front Panel

- 1 LCD
- 2 Function key
- 3 Power switch
- 4 External trigger input terminal
- 5 Remote sense terminal
- 6 Input binding ports
- 7 Knob
- 8 Entry keys / Secondary function keys
- 9 LED displays (remote and fault status)
- 10 Function selector switch key
- 11 Left & Right key
- 12 Up/Down keys, display selector switch key

1.3 Rear Panel

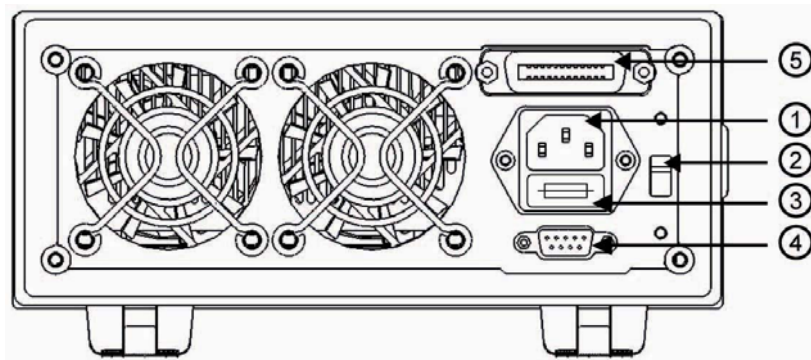

Figure 1.2 Rear Panel

- 1 AC input socket
- 2 Line voltage switch
- 3 Fuse holder
- 4 RS232 interface
- 5 GPIB interface (optional)























1.4 Keypad Function

There are three groups of keypads on the front panel: the Function Keys, the Entry Keys, which composite with secondary functions, and the Direction Keys. The secondary functions of the Entry Keys are printed in blue. To use the secondary function, please press



key first, then press the relevant key.

Liste 1.1 Description of Keys



	„Local“ key
	„Save“ key
	„Recall“ key
	„Error“ key
	„Start“ key (for sequence)
	„Stop“ key (for sequence)
	„Battery“ key (for battery discharge mode)
	„Insert“ key
	„Delete“ key
	„List“ key (for sequence)
	„Trigger“ key
	„Clear“/„ProtClear“ key to quit the selected menu
	„Menu“ key for main menu
	„Tran“ key for transient operation
	„Set“ key for operating mode / Parameter
	„Input on/off“ key
	„Enter“ key (represented as Enter in the manual)
	„Left“ cursor key (represented as ◀ in the manual)
	„Right“ cursor key (represented as ▶ in the manual)
	„Up“ cursor key (represented as ▲ in the manual)
	„Down“ cursor key (represented as ▼ in the manual)
	„2nd“ key (function selector switch)



Note

▲ ▼ keys can be used as a selector switch keys for displaying load status and actual power during basic operating modes.

1.5 Displays

	REM	REM Indicates that the electronic load is in remote status.
	ERR	Indicates that a remote programming error has occurred.

1.6 Menus

1.6.1 Main Menu

Press **Menu** key to enter into main menu. Please see the list below for main menu content:

List of available functions and parameters:

Function/Parameter		Description
Load Default Yes *No		Restore default Yes *No
Short On *Off		Short circuit mode On *Off
Von Latch On *Off		Von Latch On *Off
Von Point 0.000v		Set Von voltage point Von point
CV Curr Limit 40.00A		Current limit in CV mode Current limit
Curr Rise Rate 4,000A/us		Current rise rate in CC mode Current rise rate
Curr Fall Rate 4,000A/us		Current fall rate in CC mode Current fall rate
Trig Function *Tran List		Trigger function selection Transient test Sequence test (list)
Knob On *Off		Enable/disable knob function On *Off
Key Sound On *Off		Enable/disable key sound On *Off
Interface *RS232 GPIB		Remote interface selection RS232 GPIB
RS232 interface	Baud rate 2400 4800 *9600 19200 38400	Baud rate setting 2400 4800 9600 19200 38400
	Parity Check *None Even Odd	Parity check setting None Even Odd
	Data Bit *8 7	Data bits length 8bits 7bits
	Stop Bit *1 2	Stop bit length 1bit 2bits
	Flow Control On *Off	Enable/disable flow control On *Off
GPIB interface	GPIB address 5	GPIB address Address value



Note

Except knob, key sound and interface configurations, the other parameters in main menu will not be saved when the load is turned off. If it is needed to save the parameters, please use **2nd** key and **ESC** key or *sav command. When the load is turned on next time, the saved parameters in location 0 will be recalled automatically.

1.6.2 Mode Selection and Parameter Setting Menu

Press **Set** key to enter into mode selection and parameter setting menu, which is shown as below:

Function / Parameter	Description
MODE : CCL CURR : 0.000A	Constant current low range Immediate current level
MODE : CCH CURR : 0.000A	Constant current high range Immediate current level
MODE : CV VOLT : 80.00V	Constant voltage mode Immediate voltage level
MODE : CRL RES : 2.000Ω	Constant resistance low range Immediate resistance level
MODE : CRM RES : 20.000Ω	Constant resistance medium range Immediate resistance level
MODE : CRH RES : 20.000Ω	Constant resistance high range Immediate resistance level
MODE : CPV POWR : 0.000W	Constant power-voltage source mode Immediate power level
MODE : CPC POWR : 0.000W	Constant power-current source mode Immediate power level

1.6.3 Transient Operation Menu

Press **Tran** key in desired mode to enable its transient operation, and press **Set** key to enter into transient setting menu, which is shown as below:

Function	Description	Example
LevelL	Transient low level	1.000 A
LevelH	Transient high level	2.000 A
TimeL	Time for transient low level	600.00 ms
TimeH	Time for transient high level	600.00 ms
TimeR	Time for transient rising edge	0.01 ms
TimeF	Time for transient falling edge	0.01 ms
MODE	Continuous (Cont) Pulse (Puls) Toggle (Togg)	Cont



Note

Transient operation may be used in CC, CV, and CR modes.

1.6.4 List Operation Menu

Press **2nd** key and **9** key to enter into the list operation menu, which is shown as below:

Function	Description
No.	Select sequence (list) number (0-6)
Memo	Sequence memo (10 characters)
Data: <New/Edit>	Create a new or edit an existing sequence
Count	Cycle times (1-65535)
Chain: Off	Sequence number to be chained with (0-6, off)

Press **▲** and **▼** keys in list operation menu to select Data: <New/Edit>, and select New or Edit with the knob or **◀** and **▶** keys. Then press key to **Enter** into sequence data editing status, which is shown as below:

Function	Description
01. 10000.00000s	Sequence (list) number Time
CCH 5.000A	Mode Setting value

1.7 Display Messages

① CC Mode:

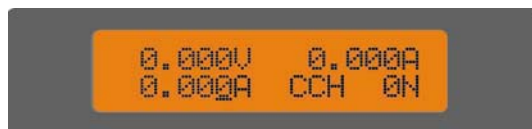

The first line shows measured voltage and current levels. The second line shows current setpoint, CC mode (CCH indicates constant current high range; CCL indicates constant current low range) and input status of the load: (ON, OFF).

② CV Mode:



The first line shows measured voltage and current levels.
The second line shows voltage setpoint, CV mode, and input status of the load: (ON, OFF).

③ CR Mode:



The first line shows measured voltage and current levels.
The second line shows resistance level, CR mode (CRL indicates constant resistance low range; CRM indicates constant resistance medium range; and CRH indicates constant resistance high range) and input status of the load: (ON, OFF).

④ CP Mode:



The first line shows measured voltage and current levels.

The second line shows power setpoint, CP mode (CPC indicates constant power-current source mode; CPV indicates constant power-voltage source mode), and input status of the load: (ON, OFF).

⑤ Transient Operation:



The first line shows measured voltage and current levels.

The second line shows setpoint level, transient operation mode („t“ stands for transient) and input status of the load: (ON, OFF).

⑥ List Operation:



The first line shows measured voltage and current levels.

The second line shows setpoint, sequence operation mode („L“ indicates list test); and input status of the load: (ON, OFF).

⑦ Battery Discharge Operation:



The first line shows measured voltage and current levels.

The second line shows the consumed battery power (in Ah) and discharge time.

⑧ Short Circuit Operation:

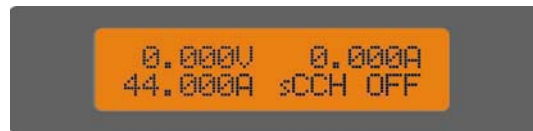

The first line shows measured voltage and current levels.

The second line shows setpoint level in short circuit, short circuit operation mode ("s" indicates short circuit test), and input status of the load (ON, OFF).

⑨ Display Momentary Power:

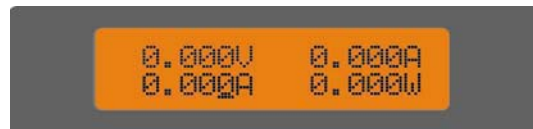

Pressing ▲ and ▼ key can switch between the display of load status and momentary power. On the display screen of actual power, the first line shows momentary voltage and current.

The second line shows setting value and power level.

⑩ Protection Status:

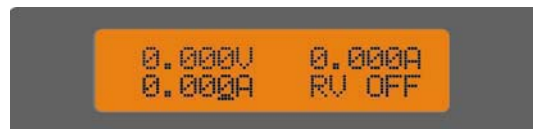

If the protection function has been activated, LCD will display corresponding protection status.

Example: The display of reverse voltage protection status is shown as below:



Protection status includes overcurrent (OC), overvoltage (OV), overpower (OP), over temperature (OT), load protection (PT), and reverse voltage (RV).



1.8 Remote Programming

The commands are sent to electronic load via remote interface (RS232, GPIB), and will be executed after decoding by the processor. If there is any error occurs to the command, the processor can detect the wrong command and error type, and it can maintain the status register as well.

2 Functions and Features

2.1 Front Panel Operation („Local“) and Remote Control Operation

SPL Series electronic load can be controlled via the keypad and knobs in the front panel, or by remote controller via remote interface. If it is needed to control the load via the front panel, the load has to stay in local control status. Local (front panel) control is in effect immediately after power is applied. The REM indicator is turned on, and remote control goes into effect as soon as the load receives a SYSTem:REMOte command via RS232 or GPIB interface.

Under remote control status, all operations on front panel keypad and knobs become invalid (except  key and  key). All operations on electronic load are controlled by remote controller. The electronic load will return to local control and REM remote control indicator is turned off after receiving the return command (SYSTem:LOCAl).

Alternatively, you can return the electronic load to local control by pressing  key and  key.

Details of local operation are covered in Chapter 4 „Local Operation“ and fundamentals of remote programming are given in Chapter 5 „Remote Programming Operation“.

Complete SCPI programming details are given in the SCPI Programming Guide for SPL Loads.

2.2 Programmable Functions

- CC (constant current) Mode: CCL, CCH
- CV (constant voltage) Mode: CV
- CR (constant resistance) Mode: CRL, CRM, CRH
- CP (constant power) Mode: CPV, CPC
- Transient Operation: Tran
- List Operation: LIST
- Battery Discharge Operation: BATTERY
- Short Circuit Operation (Short)

2.3 Basic Test Functions

There are four basic test functions:

- Constant current (CC),
- Constant voltage (CV),
- Constant resistance (CR),
- Constant power (CP).

The operating mode and the associated parameters can be set via front panel or remote command. The load will remain in current mode until the mode is changed. If the mode is changed when the load's input is in ON status, the load will be turned off for around 5 milliseconds automatically.

The setting values for electronic load become effective immediately when the load is turned on. If the input set value exceeds the allowed range, it will be automatically limited at maximum value or minimum value.

2.3.1 Constant Current Mode (CC)

Constant current mode has two ranges, the high range (CCH) and the low range (CCL). The high range provides wider test range. The low range provides better resolution at low current settings.

In CC mode, the load will sink a constant current in accordance with the programmed value regardless of the change of input voltage (see Figure 2.1). Press **Set** key in basic mode to enter into mode selection and parameter setting menu.

Choose CCH or CCL mode with ▲ and ▼ keys. Input the current level via the Entry keys or the knob with ◀ and ▶ keys. Use the **Enter** key for confirmation. The CC mode and parameters can also be set via remote command (MODE CCL, MODE CCH, CURRent <NRf+>).

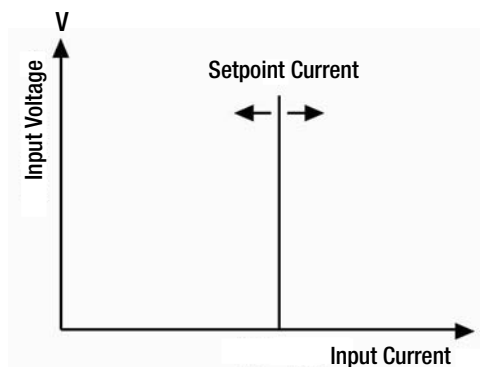

Figure 2.1 Constant Current Mode (CC)

2.3.1.1 Setting Ranges

In CC mode low range (CCL), the setting range for the current setpoint is 0 ... 10% of the maximum nominal input current, respectively. In CC mode high range (CCH), the setting range for the current setpoint is 0 ... 100% of the maximum nominal input current, respectively.

If the mode is changed when the load's input is in ON status, the load will be turned off for around 5 milliseconds automatically. For example: when the load is switched from CCL to CCH, the input will be turned off around 5 milliseconds.

Besides, it is noted that the current setpoint may change with the current level to fit the new range.

Example: the present setting is CCH 10.000 A, when the load is switched from CCH to CCL, the current setpoint level will change to the maximum level of 4.0000 A (SPL 400-40) for CCL.

2.3.1.2 Immediate Current Level

The immediate current level refers to the current set value in CC mode, which can be programmed via mode selection and parameter setting menu, or via remote command (CURRent <NRf+>). The immediate current level can also be modified directly with ◀ ▶ cursor keys () and the knob.

2.3.1.3 Triggered Current Level

The triggered current level refers to the preset current value, which can become immediate current level automatically when a trigger is received. If the CC mode and the input are enabled, the input will be updated immediately when a trigger occurs. If the CC mode is not active, this current level will have no effect on the input until the CC mode becomes active. The triggered current level only can be set via remote command (CURRent:TRIGgered <NRf+>). Once a current level is triggered, subsequent triggers will become invalid until another (CURRent:TRIGgered <NRf+>) command is received.

The trigger operation is described in detail in one of the following chapters. The status register of the electronic load can keep track of pending triggers and other operating conditions, which will be described in detail in the "SPL SCPI Programming Guide".

2.3.1.4 Transient Current Level

The load will switch between the transient high current level (LevelH) and transient low current level (LevelL) when the transient operation is enabled. The transient current level can be set in transient operation menu from the front panel, or via remote command (CURRent:HIGH <NRf+>, CURRent:LOW <NRf+>).

2.3.1.5 Programmable Maximum Current Level

Via a remote command (CURRent:PROTection <NRf+>) a maximum current level can be set 0 ... 100% of the maximum nominal input current, resp.). If this level is exceeded beyond a programmable time delay (0.001 ... 60 s), an acoustic alarm signal is generated and the load is switched off. The maximum current level can be programmed in all operating modes.

2.3.2 Constant Voltage Mode (CV)

In CV mode, the load will attempt to sink enough current to control the source voltage to the programmed constant value regardless of the change of input current. (see Figure 2.2). Press **Set** key in basic mode to enter into mode selection and parameter setting menu. Choose CV mode with **▲** and **▼** cursor keys. Input the voltage setpoint value via the Entry keys or the knob with **◀ ▶** cursor keys. Press **Enter** for confirmation.

The CV mode and parameters can also be set via remote command (MODE CV, VOLTage <NRf+>).

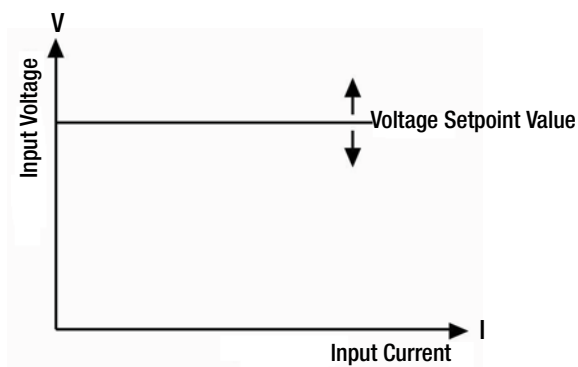

Figure 2.2 Constant Voltage Mode (CV)

2.3.2.1 Setting Ranges

The setting range for voltage is 0 ... 80 V or 0 ... 200 V, depending on the model.

2.3.2.2 Immediate Voltage Level

The immediate voltage level refers to the voltage setpoint value in CV mode, which can be set via mode selection and parameter setting menu, or via remote command (VOLTage <NRf+>). The immediate current level can also be modified directly with the **◀ ▶** cursor keys and the knob in CV mode.

2.3.2.3 Triggered Voltage Level

The triggered voltage level refers to the preset voltage value, which can become immediate voltage level automatically when a trigger is received. If the CV mode and the input are enabled, the input will be updated immediately when a trigger occurs. If the CV mode is not active, this voltage level will have no effect on the input until the CV mode is active. Once a voltage level is triggered, subsequent triggers will become invalid until another (VOLTage:TRIGgered <NRf+>) command is received.

The trigger operation will be described in later chapter. The status register of the electronic load can keep track of pending triggers and other operating conditions. which will be described in details in the "SPL SCPI Programming Guide".

2.3.2.4 Transient Voltage Level

The load will switch between the transient high voltage level (LevelH) and transient low voltage level (LevelL) when the transient operation is enabled. The transient voltage level can be set in transient operation menu from the front panel, or via remote command (VOLTage:HLevel <NRf+>, VOLTage:LLevel <NRf+>).

2.3.3 Constant Resistance Mode (CR)

Constant resistance mode has three ranges: the low range (CRL), the medium range (CRM), and the high range (CRH). In CR mode, the load is equivalent to a constant resistance and will sink a current linearly proportional to the input voltage in accordance with the programmed resistance to make $I=U/R$ (see Fig.2-3). Press **Set** key in basic mode to enter into mode selection and parameter setting menu. Choose CR mode with **▲** and **▼** keys. Input the resistance value via the Entry keys or the knob and with **◀** and **▶** keys. Use **Enter** key for confirmation. The CR mode and parameters can also be set via remote command (MODE CRL, MODE CRM, MODE CRH, RESistance <NRf+>).

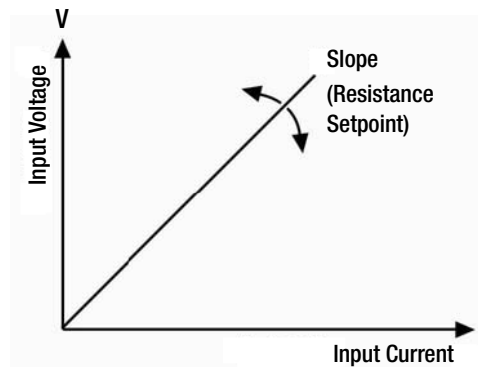

Figure 2.3 Constant Resistance Mode (CR)

2.3.3.1 Setting Ranges

Constant resistance 80 V models

low value range (CRL) = 0.02 ... 2 Ω ,
medium value range (CRM) = 2 ... 200 Ω ,
high value range (CRH) = 20 ... 2000 Ω .

Constant resistance 200 V models

low value range (CRL) = 0.0666 ... 6.66 Ω ,
medium value range (CRM) = 6.66 ... 666 Ω ,
high value range (CRH) = 66.6 ... 6660 Ω .

Each time the setting range is changed while the load's input stays in ON status, the load will be turned off for around 5 milliseconds. For example, when the load is switched from CRL to CRH, the input will be turned off around 5 milliseconds. Besides, it is noted that the resistance setpoint may change with the resistance range to fit the new range.

Example: the present setting is CRM 10.000 Ω , when the load is switched from CRM to CRL, the resistance setpoint will change to the maximum level 2.0000 Ω for CRL.

2.3.3.2 Immediate Resistance Level

The immediate resistance level refers to the resistance setpoint value in CR mode, which can be set via mode selection and parameter setting menu, or via remote command (RESistance <NRf+>). The immediate resistance level can also be modified directly with the **◀** **▶** keys and the knob in CR mode.

2.3.3.3 Triggered Resistance Transition

The triggered resistance transition refers to the preset resistance setpoint value, which can become immediate resistance setpoint value automatically when a trigger is received. If the CR mode and the input are enabled, the input will be updated immediately when a trigger occurs. If the CR mode is not active, this resistance level will have no effect on the input until the CR mode becomes active.

The triggered resistance level only can be set via remote command (RESistance:TRIGgered <NRf+>). Once a resistance level is triggered, subsequent triggers will become invalid until another (RESistance:TRIGgered <NRf+>) command is received. The trigger operation will be described in later chapter. The status register of the electronic load can keep track of pending triggers and other operating conditions, which will be described in details in the "SPL SCPI Programming Guide".

2.3.3.4 Transient Resistance Level

The load will switch between the transient high resistance level (LevelH) and transient low resistance level (LevelL) when the transient operation is enabled. The transient resistance level can be set in transient operation menu from the front panel, or via remote command (RESistance:HIGH<NRf+>, RESistance:LOW <NRf+>).

2.3.4 Constant Power Mode (CP)

There are two sorts of constant power modes, the Constant Power-Voltage Source mode (CPV) and the Constant Power-Current Source mode (CPC). The CPV mode is applied to voltage source test, and the CPC mode is applied to current source test. In CP mode, the load consumes the constant power in accordance with the programmed value regardless of the changes of external current and voltage (see Figure 2.4). Press the **Set** key to enter into mode selection and parameter setting menu. Choose CPV or CPC mode with **▲** and **▼** keys.

Input the power value via Entry keys or the knob with **◀** and **▶** keys. Use **Enter** key for confirmation. The CP mode and parameters can also be set via remote command (MODE CPV, MODE CPC, POWER <NRf+>).

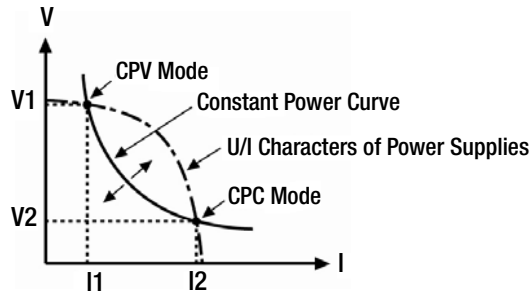

Figure 2.4 Constant Power Mode (CP)

Figure 2.5 shows the current-voltage curves for several common power supplies. The constant power curve is a hyperbola in the first quadrant. The constant power curve usually intersects with current-voltage curve at two points (the CPV point and the CPC point) when the power of the external power supply is larger than the set power. At the CPV point, the power supply shows the feature of voltage source: the output power will be increased with increasing current; at the CPC point, the power supply shows the feature of current source: the output power will be increased with increasing voltage. SPL Series electronic load can be set at any one of intersection points to be operated by the user.

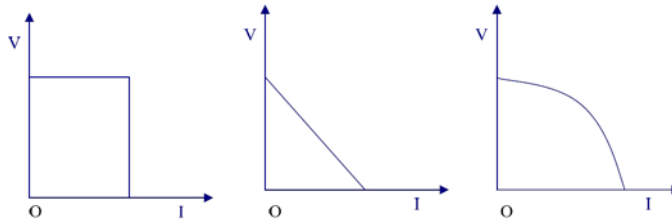

Figure 2.5 Current-voltage Curves for Normal Power Supply

As it adopts the advanced slope detection method, SPL 250-30/SPL 400-40 Series electronic load only needs to test a part of the current-voltage curve to know whether the two curves (constant power curve and current-voltage curve) intersect. Therefore, when the set power is larger than the actual power, the external power supply will not be short-circuited by the load for the insufficient power. When the load detects that the power of the external power supply is insufficient, it will try to find constant power point automatically till the set power is met.

2.3.4.1 Setting Ranges

The setting range for the power setpoint value for both CPV and CPC mode is 0 ... 250 W (SPL 250-30), for 0 ... 400 W (SPL 400-40), for 0 ... 200 W (SPL 200-20) and for 0 ... 350 W (SPL 350-30).

2.3.4.2 Immediate Power Level

The immediate power level refers to the power set value in CP mode, which can be set via mode selection and parameter setting menu, or via remote command (POWER <NRf+>). The immediate resistance level can also be modified directly with **◀ ▶** cursor keys and the knob.

2.3.4.3 Triggered Power Level

The triggered power level refers to the preset power value, which can become immediate power level automatically when a trigger is received. If the CP mode and the input are enabled, the input will be updated immediately when a trigger occurs. If the CP mode is not active, this power level will have no effect on the input until the CP mode becomes active. The triggered power level only can be set via remote command (POWER:TRIGgered <NRf+>). Once a power level is triggered, subsequent triggers will become invalid until another (POW:TRIG<NRf+>) command is received. The trigger operation will be described in later chapters. The status register of the electronic load can keep track of pending triggers and other operating conditions, which will be described in detail in the "SPL SCPI Programming Guide".

2.4 Transient Operation

When the transient operation is enabled, the load periodically switches between two levels (LevelH and LevelL), which can be applied to test the dynamic characteristics of the power supply. The transient operation can be executed in the CC, CV and CR modes, and has three operating statuses: Continuous, Pulsed, and Toggled. Please make sure the List Operation has been disabled before enabling transient operation.

The parameters associated with transient operation are: low level (LevelL), high level (LevelH), low level time (TimeL), high level time (TimeH), time for rising edge (TimeR), time for falling edge (TimeF), and operating mode.

Transient high/low level and corresponding CC, CV and CR modes share the same setting ranges.

The range for high/low level time is 0 ~ 655.35ms; the range for rising/falling edge time is 10 μ s ~ 655.35ms; the time resolution is 10 μ s, and the maximum test frequency is 50 kHz.

Transient test can be turned on and off via **Tran** key at the front panel or via remote command (TRANSient ON/OFF). Before you turn on transient test, you should set the load to the operating mode that needs transient test.



Attention!

In transient operation, the operating mode cannot be changed.



Attention!

In transient test, the Von point and current limit should be taken into consideration, which may cause the shut down of the input, thus interrupting the transient test.

2.4.1 Continuous Transient Operation

In continuous operation, the load periodically switches between high/low levels.

The relevant parameters such as

- low level (LevelL),
- high level (LevelH),
- low level time (TimeL),
- high level time (TimeH),
- time for rising edge (TimeR),
- time for falling edge (TimeF) und
- continuous transient operation (cont)

can be set through transient operation menu or via remote command

- (CURRent:LLEVel <NRf+>),
- CURRent:HLEVel <NRf+>),
- VOLTage:LLEVel <NRf+>),
- VOLTage:HLEVel <NRf+>),
- RESistance:LLEVel <NRf+>),
- RESistance:HLEVel <NRf+>),
- TRANSient:LTIME <NRf+>),
- TRANSient:HTIME <NRf+>),
- TRANSient:RTIME <NRf+>),
- TRANSient:FTIME <NRf+>),
- TRANSient:MODE CONTInuous)

Example: assume that the CCH range is active, and the input is in OFF status, then the transient parameters should be set as follows:

Press **Tran** key to enter into transient operation.

Press **Set** key to open transient operation menu.

Set the following parameters in transient operation menu:

LevelL	5.000 A
LevelH	10.000 A
TimeL	0.50 ms
TimeH	0.50 ms
TimeR	0.20 ms
TimeF	0.20 ms
Mode	Cont

Then press **Input on/off** key to turn on the input;

Or via remote command to set:

SCPI Command	Description
TRAN ON	Enables transient operation
CURR:LLEV 5	Sets transient current low level to 5 A
CURR:HLEV 10	Sets transient current high level to 10 A
TRAN:LTIM 500 μ s	Sets transient low level time to 500 μ s
TRAN:HTIM 500 μ s	Sets transient high level time to 500 μ s
TRAN:RTIM 200 μ s	Sets the time for transient rising edge to 200 μ s
TRAN:FTIM 200 μ s	Sets the time for transient falling edge to 200 μ s
TRAN:MODE CONT	Selects continuous operation
INPUT ON	Turns on the power input

Figure 2.6 shows the current waveform of the load: the load's input current reaches the transient high level (10A) after 200 μ s duration of rising edge, and remains at 10A for 500 μ s. Then after 200 μ s duration of falling edge, the input current reaches the transient low level (5A), and remains at 5A for 500 μ s. Repeat it in cycles.

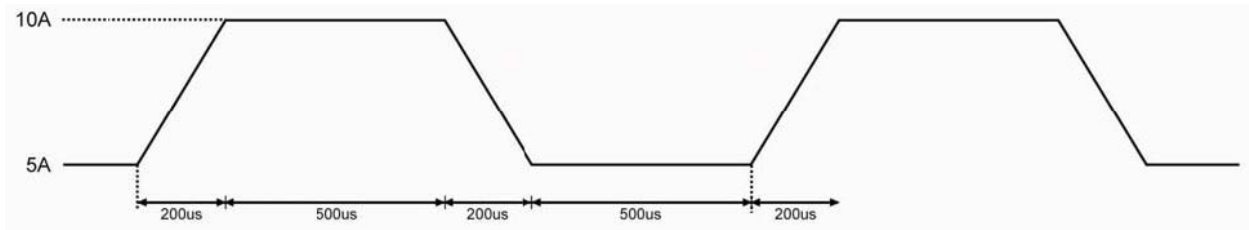

Figure 2.6 Continuous Transient Operation

2.4.2 Pulsed Transient Operation

The trigger function is required for pulsed transient operation. As long as no trigger occurs, the load remains at the transient low level. After a trigger has been received, the load switches to high level and remains at this level for a programmed time span, subsequently, the load returns to low level again. The associated parameters such as

- low level (LevelL),
- high level (LevelH),
- high level time (TimeH),
- time for rising edge (TimeR),
- time for falling edge (TimeF) and
- pulsed transient mode (pulse)

can be set through transient operation menu or via remote command

- (CURRent:LLEVel <NRf+>>,
- CURRent:HLEVel <NRf+>,
- VOLTagE:LLEVel <NRf+>,
- VOLTagE:HLEVel <NRf+>,
- RESistance:LLEVel <NRf+>,
- RESistance:HLEVel <NRf+>,
- TRANsient:HTIME <NRf+>,
- TRANsient:RTIME <NRf+>,
- TRANsient:FTIME <NRf+>,
- TRANsient:MODE PULSe).

Low level time (TimeL) has no influence on pulsed transient mode.

In order to get a pulse, an explicit trigger is required. The trigger can be an external trigger signal received via the TRIG input on the

front panel, pressing the  key and  key, via GPIB function **GET**, or via the common command ***TRG** or the subsystem command **TRIG**.

The trigger becomes effective only when the load remains at transient low level. Each trigger leads to one pulse. In the duration of rising edge, transient high level, and falling edge, any trigger will be ignored.

Example: assume that the CCH range is active, and the input is in OFF status, then the transient parameters should be set as follows:

Press  key, to enter into transient operation.

Press  key, to open transient operation menu.

Set the following parameters in transient operation menu:

LevelL	5.000A
LevelH	10.000A
TimeH	0.50ms
TimeR	0.10ms
TimeF	0.10ms
Mode	Puls

Then press the **Input on/off** key to turn on the input.

Or via remote command to set:

SCPI Command	Description
TRIG:SOUR EXT	Selects the external trigger input
TRAN ON	Enables transient operation
TRAN:LLEV 5	Sets transient current low level to 5 A
TRAN:HLEV 10	Sets transient current high level to 10 A
TRAN:HTIM 500us	Sets transient high level time to 500 μ s
TRAN:RTIM 100us	Sets the time for transient rising edge to 100 μ s
TRAN:FTIM 200us	Sets the time for transient falling edge to 200 μ s
TRAN:MODE PULS	Sets pulse trigger operating mode
INPUT ON	Turns on the input

Get the trigger by receiving an external trigger signal. Figure 2.7 shows the current waveform of the load before it is triggered and after it has been triggered respectively: the electronic load starts its operation at the transient low level (5A) when the input is turned on. For each trigger, the load current reaches the high level (10A) after 200 μ s duration of rising edge, and remains at 10A for 500 μ s. Then after 200 μ s duration of falling edge, the current returns to the transient low level (5A).

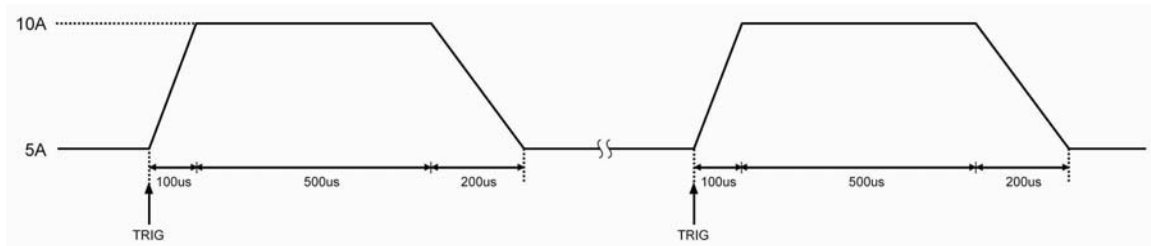

Figure 2.7 Pulsed transient operation

2.4.3 Toggled Transient Mode

The trigger function is required for toggled transient operation. As long as no trigger occurs, the load remains at transient low level. After a trigger has been received, a toggle operation will be executed, and high transient level will be reached after the duration of rising edge. The load will keep this level until a new trigger is received. Once this happens, the load will return to transient low level after the duration of falling edge. The load will switch between the levels each time a trigger is received.



The associated parameters such as

- low level (LevelL),
- high level (LevelH),
- time for rising edge (TimeR),
- time for falling edget (TimeF) and
- toggled transient mode (toggle)

can be set through transient operation menu or via remote command

- (CURRent:LLEVel <NRf+>>,
- CURRent:HLEVel <NRf+>,
- VOLTage:LLEVel <NRf+>, VOLTage:HLEVel <NRf+>>,
- RESistance:LLEVel <NRf+>>,
- RESistance:HLEVel <NRf+>>,
- TRANsient:RTIME <NRf+>>,
- TRANsient:FTIME <NRf+>>,
- TRANsient:MODE TOGGLE).

Low level time (TimeL) and high level time (TimeH) have no influence on toggled transient mode.

The trigger can be an external trigger signal received via the TRIG input on the front panel, pressing the  key and  key, or via the GPIB GET function, the common command *TRG or the subsystem command TRIG.

For example: assume that the CCH range is active, and the input is in OFF status, then the transient parameters should be set as follows:

Press the  key to enter into transient operation.

Press the  key to open transient operation menu.

Set the following parameters in transient operation menu:

LevelL	5.000 A
LevelH	10.000 A
TimeR	0.10 ms
TimeF	0.20 ms
Mode	Togg

Then press the  key to turn on the input.

Alternatively, set the parameters via remote command:

SCPI Command	Description
TRIG:SOUR EXT	Selects the external trigger input
TRAN ON	Enables transient operation
TRAN:LLEV 5	Sets transient current low level to 5A
TRAN:HLEV 10	Sets transient current high level to 10A
TRAN:RTIM 100us	Sets the time for transient rising edge to 100 µs
TRAN:FTIM 200us	Sets the time for transient falling edge to 200 µs
TRAN:MODE TOGG	Selects toggled operating mode
INPUT ON	Turns on the input

Get the trigger by receiving an external trigger signal. Figure 2.8 shows the current waveform of the load before it is triggered and after it has been triggered respectively: the electronic load starts its operation at the transient low level (5A) when the input is turned on. For the first trigger, the load current reaches and remains at the high level (10A) after 100 µs duration of rising edge. When the second trigger is received, the load current will reach and remain at the low level (5A) after 200 µs duration of falling edge. Each trigger leads to one toggle operation.

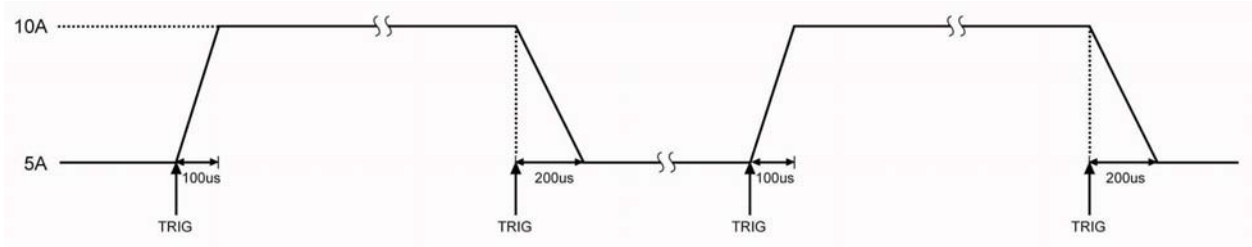

Figure 2.8 Toggled Transient Operation

2.5 List Operation

Besides Transient operation, the electronic load provides more flexible list operation, which can make the load operate according to the preset sequence.

The list operation allows you to program a series of sequence steps, and the operation mode, the load values, the duration time for each step can be set. The sequence operation can be executed in the CC, CV, and CR modes. The minimum duration for each step is 10µs, and the maximum one is 99999.99999 s (around 27.78 hours). The list operation allows to be executed cyclically, and the cycle times can be set; the different lists can be chained so that when one list has been executed, the other chained list will be enabled, which further perfects the capability of the load to implement more complicated test tasks. Each list can contain 50 steps at most, and the load can store 7 lists.

The associated parameters of a list operation can be edited and set through the list operation menu or via remote command. The load provides convenient list editing functions. When the user is operating input/edit sequence step, it is easy to check the previous and subsequent steps, and it is allowed to edit, insert, and delete immediately, which simplifies the list input operation effectively.

The set value of each step will be automatically saved when exiting from step edit menu, and the other list parameters will be saved immediately after been edited.

The list operation also can be implemented via the remote command.

Please make sure the transient operation has been disabled before enabling list operation. In list operation, if the operation mode for next step is different from the present step, the load will automatically have a 5 ms-delay after the present step is over to avoid the probable current surge. The load's input will be turned off during this 5 ms-delay.

Figure 2.9 is a list running diagram for 5 steps. See section 5 for detailed information about programming lists from the front panel.

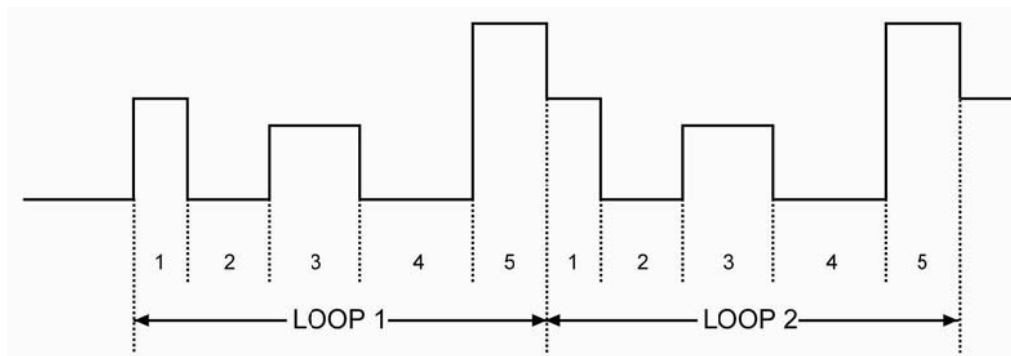

Figure 2.9 List Operation



Attention!

In list operation, the Von point and current limit level should be taken into consideration, which may cause the shut down of the input, thus interrupting the list operation.

2.6 Battery Discharge Operation

The electronic load adopts constant current discharge to test the battery capacity. The **discharge current** and **cut-off voltage** can be self-defined. When the battery voltage decreases to the cut-off voltage, the battery discharge test will stop automatically. The test procedure is shown in Figure 2.10. The load can real-time display battery voltage, discharge current, discharge time, and discharge capacity during the test. The maximum battery discharge time is 99 hours, 99 minutes, 99 seconds, with a maximum battery capacity of 4000 Ah (SPL 400-40), 3000 Ah (SPL 350-30, SPL 250-30), 2000 Ah (SPL 200-20).

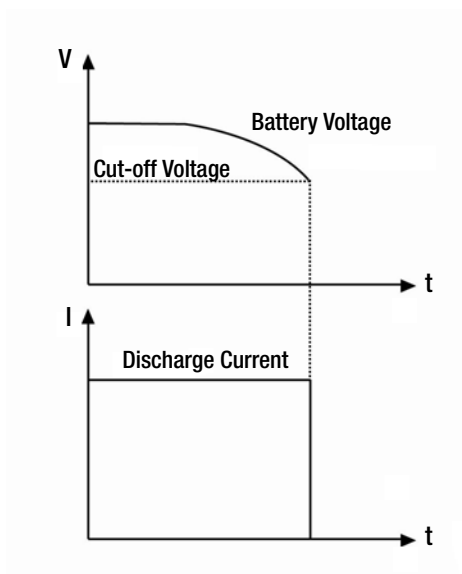

Figure 2.10 Voltage/Current Curve Chart in Battery Discharge Operation

2.7 Short Circuit Operation

The electronic load can simulate a short circuit to test the protection performance of the tested device. The short circuit operation can be enabled and disabled by setting in the main menu, or via the remote command (INPut:SHORT ON/OFF). The other set values will not be changed when the short circuit operation is enabled. The short-circuit value depends on the present operating mode of the load, and the short-circuit value for each model is shown as follows:

Example for SPL 400-40

CCL, Short Circuit Current	4.4 A
CCH, Short Circuit Current	44 A
CV, Short Circuit Voltage	0 V
CRL, Short Circuit Resistance	1.8 Ω
CRH, Short Circuit Resistance	18 Ω
CPV, Short Circuit Power	420 W
CPC, Short Circuit Power	0 W

The parameters for the other models are listed in the datasheet on the attached CD ROM or on the Internet at www.gossenmetrawatt.com.

The other setting values remain unchanged for short circuit operation.



Attention!

In short circuit operation, the Von point and current limit level should be taken into consideration, which may cause the shut down of the input, thus interrupt the short circuit operation.

2.8 Triggered Operation

The triggered operation is mainly used to make the load keep synchronized with other test equipments or events. SPL Series electronic load provides various triggering modes, which can be applied to the following occasions:

- **Triggering a preset level**

Transfer all pending preset levels to the immediate levels. For the presently active mode, the new level will appear at the input at once if the input is turned on. For the modes which are not presently active, the preset levels will not take effect at the input until the corresponding mode becomes active.

- **Triggering a transient pulse**

Generate a transient pulse in accordance with the preset transient parameters, when pulsed transient operation is active.



- **Triggering a transient toggle**

Switch the input between the transient low level and transient high level in accordance with the preset transient parameters, when the toggled transient operation is active.

- **Triggering a list test**

Enable the present list test when the list operation is active.



Three triggering methods are available for remote control: GPIB <GET> signal, the *TRG and TRIGger commands.

The external trigger input terminal and  key +  key on the front panel of the load can be used to trigger as well.

The load has three triggering modes: BUS, EXTERNAL and HOLD.

- **The BUS mode:** the trigger source is GPIB <GET> signal, or *TRG command.

- **The EXTERNAL mode:**

Choose the External trigger input terminal or  key +  key on the front panel as the trigger source.

The input signal at the External trigger input terminal is TTL, the falling edge (signal) is triggered.

The HOLD mode: Use TRIGger:IMMEDIATE command as the trigger source. At this time, all other triggering methods including *TRG become invalid.



Note

The TRIGger:IMMEDIATE command can be used in all three triggering modes. The triggering modes can be selected via the remote command only (TRIGger:SOURce BUS; TRIGger:SOURce EXTERNAL; TRIGger:SOURce HOLD).

2.9 Input Control

2.9.1 Turning On/Off the Load

The input can be turned on/off by pressing the **Input on/off** key, or via the remote command (INPUT ON/OFF). If the load's input stays in OFF status, press the **Input on/off** key to turn on the input; if the load's input stays in ON status, press **Input on/off** key to turn off the input.

Turning the input on/off (zero current) does not affect the programmed settings. In local control, if the input is turned on, the load status can not be switched directly among the basic modes, transient operation, list operation, battery discharge operation, etc. The load can be switched from one operation status to another operation status only when the input is turned off.

2.9.2 Von Point / Von Latch

When the external input voltage is less than the Von Point, the load will not be enabled even though the input has been turned on.

The load will be enabled till the external input voltage reaches or exceeds the Von Point. Von Latch is used to latch the active status of the load. If the Von Latch function is enabled, once the input voltage reaches Von Point, the input will be turned on, and stay in ON status regardless of the changes from the external input voltage, even though the input voltage is less than the Von point. Please see Figure 2.11.

if the Von Latch function is disabled, once the input voltage reaches Von Point, the input will be turned on automatically, and once the input voltage is less than the Von Point, the input will be automatically turned off. Please see Figure 2.12.

The automatic turning on /off of the input can be implemented via setting the Von Point and Von Latch, which simplifies test operation greatly.

The Von voltage can be set in main menu, or via the remote command (INPut:LATCh:VOLTage <NRf+>).

The Von Latch can be set in main menu, or via the remote command (INPut:LATCh ON | OFF).

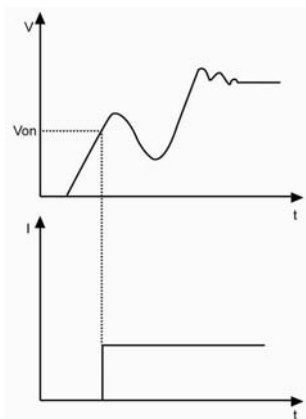

Figure 2.11 Von Latch is enabled

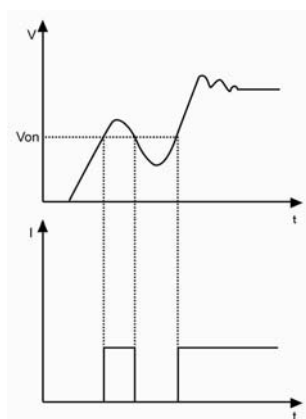

Figure 2.12 Von Latch is disabled



Note

If the load is unable to operate normally, please check the setting of Von Point.

2.9.3 Current Limit in CV Mode

The CV Current Limit is used to limit the maximum input current in CV mode. If the voltage is still larger than the setpoint while the current limit has been reached, the load will switch to the CC mode. Please see Figure 2.13.

The input will not be turned off in the CV current limit, which is different from the software current limit.

The CV Current Limit can be set in main menu, or via the remote command (INPut:LIMit:CURRent <NRf+>).

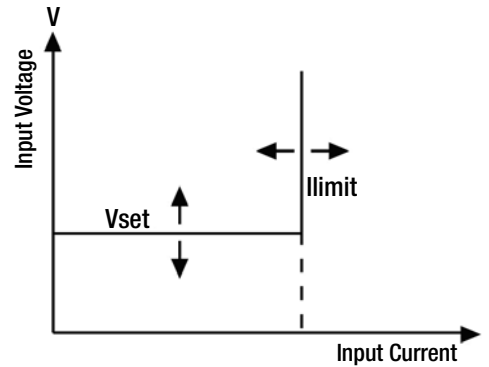

Figure 2.13 CV Current Limit

2.9.4 Current Rise Rate

The Current Rise Rate is used to set the current rise rate in CC mode. It can be set in main menu, or via the remote command (CURRent:RISE:RATE <NRf+>). If the current rise rate is 0.1 A/ μ s, and the current setpoint is 20 A, then the current rise rate is shown as below when the input is turned on, see Figure 2.14:

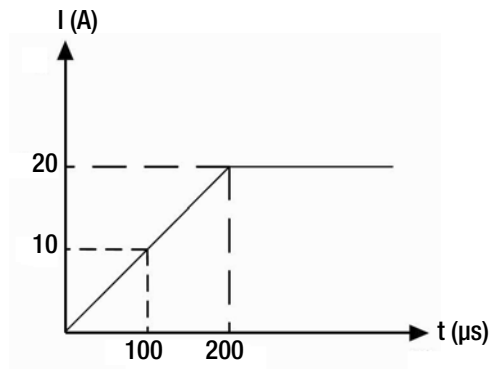

Figure 2.14 Current Rise Rate



Note

The Current Rise Rate can be effective only in CCH and CCL, and the actual rise rate is one tenth of the setpoint in CCL.

2.9.5 Current Fall Rate

The Current Fall Rate is used to set the current fall rate in CC mode. It can be set in main menu, or via the remote command (CURRent:FALL:RATE <NRf+>). If the current fall rate is 0.1 A/ μ s, and the current setpoint is 20 A, then the current rise rate is shown as below when the input is turned off, see Figure 2.15:

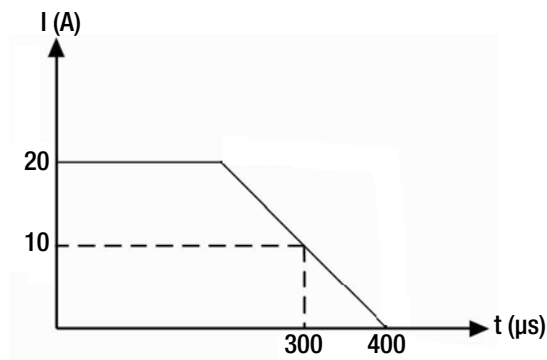

Figure 2.15 Current Fall Rate



Note

The Current Fall Rate can be effective only in CCH and CCL mode, and the actual rise rate is one tenth of the setpoint in CCL.

2.10 Measurement Function





The electronic load has measurement system with high resolution. The input current level and voltage level can be measured in real time. The input power level and resistance level can be computed with the input voltage level and current level. Each measured value can be checked through LCD display or via remote command (MEASure).

2.11 Saving and Recalling

The electronic load is provided with an EEPROM memory, which can save various parameters, such as modes, input status, current, voltage, resistance, transient settings, limits, etc.

SPL Series electronic load can save 10 groups of parameters.

All parameters relevant to saving and recalling operation are listed in List 2-1.

The 10 groups of parameters stored in Location 0~9 can be saved and recalled by pressing  key +  key and  key +  key, or via the remote command (*SAV < NRI > and *RCL < NRI >).

The parameter saved in Location 0 will be recalled automatically every time the load is turned on.

List 2-1

Function	Effect	Default using the example of SPL 400-40
Input	Input status	Off
Mode	Operation mode	CCH
Current level	Immediate current level	0 A
Current rise rate	Current rise rate	4 A/μs
Current fall rate	Current fall rate	4 A/μs
Current Hlevel	Transient current high level	0 A
Current Llevel	Transient current low level	0 A
*Current protection level	Current limit	40 A
*Current protection delay	Current protection delay	60 s
*Current protection State	Enable/disable current protection	off
Voltage level	Immediate voltage level	80 V
CV current limit	Current limit in CV mode	40 A
Voltage Hlevel	Transient high voltage level	80 V
Voltage Llevel	Transient low voltage level	80 V
Resistance level	Immediate resistance level	2000 Ω
Resistance Hlevel	Transient high voltage level	2000 Ω
Resistance Llevel	Transient low voltage level	2000 Ω
Power level	Immediate power level	0 W
Transient operation	Transient test	off
Transient mode	Transient mode	continuous
Transient Htime	Time for transient high level	0 ms
Transient Ltime	Time for transient low level	0 ms
Transient Rtime	Time for transient rising edge	0.01 ms
Transient Ftime	Time for transient falling edge	0.01 ms
Trigger Function	Trigger function selection	Tran
Trigger source *	Trigger source	external
Battery Mode	Battery discharge operation	off
Battery mini voltage	Battery minimum termination voltage	0 V
Batterieentladestrom	Battery discharge current	0 A
Voltage on	Von point for the load	0 V
Voltage on Latch	Latch the Von point	Off

* indicates it only can be programmed in the remote control.

2.12 Reading Remote Programming Errors

The Err indicator will be turned on when remote programming errors occur. The error codes are shown as followings:

-1xx	Command errors
-2xx	Execution errors
-3xx	Device-specific errors
-4xx	Query errors

Remote programming errors can be checked by pressing  key after pressing  key on the front panel. The remote command (SYSTem:ERRor?) can read back the error codes and error messages when it is in remote control.

All errors are saved in one error queue. The errors in this error queue are read in the order in which they occurred. At most 20 error messages can be saved in the error queue. If the errors exceed 20, the last error in the error queue will be replaced with -350, "Too many errors". The load will not save any additional error message, unless you clear or read errors from the queue. Once the error message is read, it will be cleared in the error queue.

2.13 Status Report

The electronic load incorporates a status reporting register. Various status conditions of the load can be reported by querying the status register. The user can make sure which event has been reported through setting the enable register, which will be introduced in detail in the SPL SCPI Programming Guide.



2.14 Protection Function



The electronic load is equipped with the following protection functions:

- Overvoltage (OV)
- Overcurrent (OC)
- Overpower (OP)
- Overtemperature (OT)
- Reverse Voltage (RV)

Once any of the above protection function is active, the corresponding status bit in the status will be set; the input will be turned off with beeps; the detected conditions will be displayed; the load will enter into the latched protection status, and will not respond to other commands except some specific operations. For example: if an overtemperature condition has been detected, the input will be turned off with beeps, and OT will be shown in the lower right corner of the display. The load will have no response to other operations.

2.14.1 Clearing Latched Protection

When the load enters into the latched protection status, it will have no response to other commands. The load will return to the normal operation only when the latched protection has been reset via pressing  key +  key or the remote command (INPut:PROTEction:CLEAr). The condition that causes the latched protection must be removed, or it will be latched again as soon as it is reset.

In addition, when the software overcurrent protection is enabled, if the overcurrent time does not exceed the specified protection time, the load will display PT to indicate, but the input will not be turned off. At this time, you can reset the overcurrent time with  key +  key or the remote command (INPut:PROTEction:CLEAr).

2.14.2 Overvoltage

The overvoltage protection level is set at a predetermined voltage, which cannot be changed by the user. When the input voltage exceeds this predetermined voltage, the overvoltage protection will be enabled, and the input is turned off with OV displayed, meanwhile, the OV and VF status register bits are set, and will remain set until they are reset and the overvoltage condition is removed.

2.14.3 Overcurrent

The electronic load allows the user to define a current protection limit. When the defined current limit is exceeded, the overcurrent timer starts timing, and the display will show PT to indicate protection status, but the input will not be turned off immediately. When the specified delay time is reached, the overcurrent protection will be enabled and the input is turned off with OC displayed, meanwhile, the OC and PS status register bits are set, and will remain set until they are reset and overcurrent condition is removed. The current protection limit function can only be set via the remote command. The function is activated or deactivated via command (CURRent:PROTEction:STATe ON/OFF). The setpoint value for overcurrent protection can be set via command (CURRent:PROTEction < NRf+>). The delay for turning the load input off can be set via command (CURRent:PROTEction:DELay < NRf+>).

2.14.4 Overpower

The electronic load includes both hardware and software overpower protection functions.

Once the input power exceeds the maximum rated power, the hardware power-limit circuit will be enabled without delay to limit the input power within the allowed range, in the meantime, the load will compute the present input power.

No matter whether the hardware power-limit circuit is enabled or not, the software overpower protection will become active as long as the overpower time exceeds the specified limit. When the overpower protection is enabled, the input will be turned off with OP displayed, meanwhile, the OP and PS status register bits are set, and will remain set until they are reset and overpower condition is removed.

2.14.5 Overtemperature

If the internal temperature of the load exceeds safe limits, the overtemperature protection will be enabled; the input will be turned off with OT displayed, in the meantime, the OT and PS status register bits are set, and will remain set until they are reset and overtemperature condition is removed. You must wait until the load cools down to the normal temperature before you can reset the latched protection. The fans in the load will help to cool the load as quickly as possible.

2.14.6 Reverse Voltage

When reverse voltage is applied, the reverse voltage protection will be enabled; the input will be turned off with RV displayed, in the meantime, the RV and VF status register bits are set, and will remain set until they are reset and reverse voltage is removed.

2.15 Auxiliary Functions

2.15.1 Trigger Function Selection

The Trigger Function in main menu is used to select the trigger object. Selecting "Tran" is used to trigger transient operation, and selecting List is used to trigger sequence (list) operation.

2.15.2 Knob Function

The Knob in main menu is used to enable/disable the knob function. Select On to enable the knob function, and select Off to disable.

2.15.3 Key Sound

The Key Sound in main menu is used to control the key sound. Select On to activate the key sound and select Off to forbid.

3 Installation

3.1 Initial Check

When you receive the load, please check it for any obvious damage that may have occurred during shipment. Keep the original packing materials in case the load has to be returned to GMC-I Service GmbH in the future.

Please confirm that there are no broken keys or knobs, that the cabinet and panel surfaces are free of dents or scratches, and that the display is not scratched or cracked.

3.2 Environment/Installation Location

The load can operate at its full power within the temperature range of 0 °C to 40 °C, and at derated power from 40 °C to 55 °C, or the overtemperature protection will be caused.

Place the load in a location with good ventilation, and keep a distance from electromagnetic interference. Do not place the load in the flammable atmosphere.

Your load must be installed in a location that allows sufficient space at the sides and rear of the load for adequate air circulation. The fans cool the load by drawing in air through the sides and exhausting it out from the back. The rubber bumpers must be removed for rack mounting.

3.3 Power-On/ Self-Test

A power-on self-test can inspect the basic operations of the load to assure you that the load is operational. First, before the load is switched on, check AC power-line voltage to verify the power-line voltage selected by 115 V/230 V Toggle Key on the rear panel is in accordance with the proper voltage in your local place.

Connect the power-line cord and a power-on self-test occurs automatically when you turn on the load. If the load detects an error during power-on self-test, the error messages will be displayed as shown below:

Error Code	Error Message
601	LCD self-test error
603	System ADC test failed
607	Rundown too noisy
608	Keypad self-test error
609	EEPROM checksum failed
630	Temperature test failed

If no error is detected, the LCD will show CCH, the initial display, and the input will be turned off. If the parameters have been modified previously and saved in location 0, the load will recall these modified parameters automatically. After around 20 minutes' warm-up of the load, the following test can be executed.

Connect the output of a power supply to the load's input with correct polarity to execute CCH 5 A and CV 5 V operations. If the load works normally, it will draw 5 A or set input voltage to 5 V within the allowed tolerance.

3.4 Connections on the Rear Panel

The rear panel of the electronic load is shown as Figure 3.1, which mainly includes AC input part and communication interface part. The AC input part includes AC input socket, Fuse holder, and Line voltage switch; the interface part includes RS-232 interface and the interface for optional GPIB.

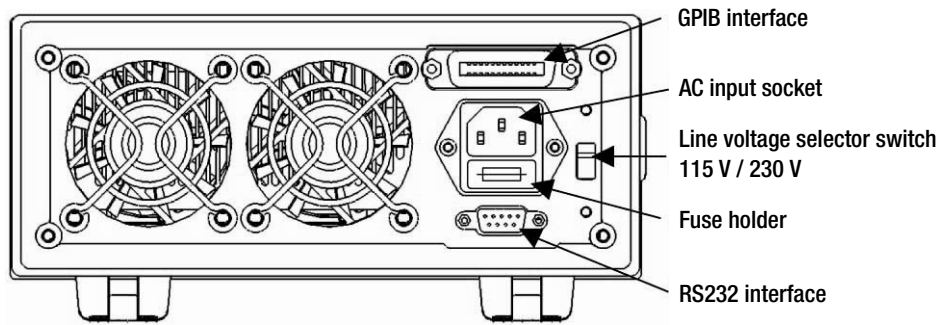

Figure 3.1 Connections on the Rear Panel

AC input

AC power-line cord must be appropriate for your local standard.

Fuse: 250 V, 315 mA

Line voltage switch can select 110V or 220V.

The selected voltage should be in accordance with the proper voltage in your local place.

Communication Interfaces

RS-232

The load provides a RS-232 interface, which is a standard DB9 pin connector using DTR and DSR to execute flow control. The pin assignment is shown below:

Pinbelegung

Pin	Input/Output	Description
1	—	not used
2	Input	RXD Receive data
3	Output	TXD Transmit data
4	Output	DTR Data terminal ready
5	Common	GND Ground
6	Input	DSR Data set ready
7	—	not used
8	—	not used
9	—	not used

The interface parameters can be set in the MENU, and you can use SCPI language for programming to realize the communication with the load.

GPIB Interface

The load provides a GPIB interface, and you can set its address to any value between 0 and 30 in MENU. When multiple GPIB devices are connected, each device on the GPIB interface must have a unique address that is not be used by the devices on other interfaces. The address is set to “05” when the load is shipped from the factory.

3.5 Connections on the Front Panel

The terminals of the electronic load on the front panel include input terminals (INPUT+, INPUT-), remote sense terminals (SENSE +, SENSE -), and an external trigger input terminal. See Figure 3.2.

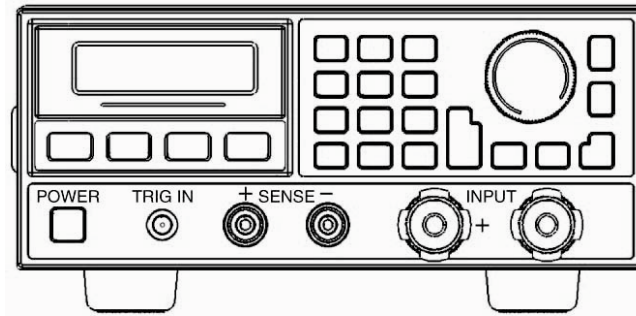

Figure 3.2 Connections on the Front Panel

Input Connections

Input connections are made to two binding posts (INPUT+, INPUT-) on the front panel. The maximum wire diameter is 6mm. In order to enhance the test accuracy, and reduce the test error when executing large current test, it would be better to use thicker wire.

Remote Sense Terminals

Remote sensing is made to two terminals (SENSE+, and SENSE-). It compensates for the voltage drop caused by the power supply and input wire resistance to achieve greater accuracy.

The electronic load can detect remote voltage inputs automatically, so there is no need to modify the parameter settings or change the hardware wiring when using remote sensing.

External Trigger Input Terminal

The external trigger input terminal on the front panel is a BNC connector, in which the middle part is the input+, and the outer casing is the input-. It receives 5 V TTL-compatible falling-edge trigger signals.

3.6 Wiring

Sense Connections

As the influence of connected power and the conductor resistance of the load, the voltage at the input terminals will be lower than output voltage when the current flows across the load. When greater accuracy of voltage test is needed, it is necessary to connect Sense input, and the load will switch to Sense status automatically. The relevant wiring is shown as Figure 3.3.

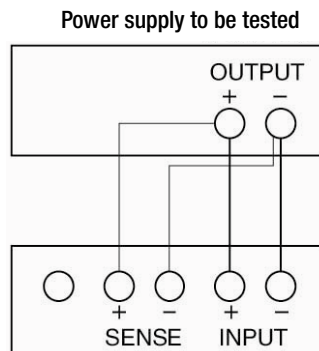

Figure 3.3 Measuring terminals

Parallel Connections

Figure 3.4 illustrates how two or more loads can be paralleled in CC /CR mode when high power or large current is needed.

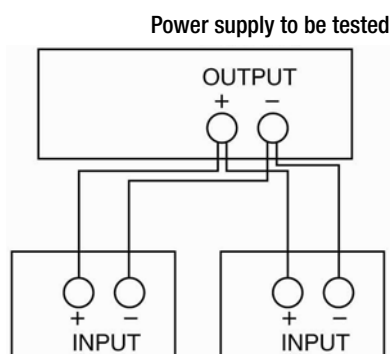



Figure 3.4 Parallel Connection

4 Local Operation

The local operation of the load has been briefly introduced in Chapter 2 „Functions and Features“. In this chapter, it will be explained in details with examples.

4.1 Local Control

If it is needed to control the load from the front panel, the load must stay in the local control status. The load enters into local control status once it is powered on, and preset parameters saved in EEPROM location 0 will be recalled automatically.

Under remote control status, all operations on front panel keypad and knobs become invalid (except  key +  key). When the load receives a remote command (SYST:REM) via RS232 or GPIB, the remote control goes into effect and REM indicator is turned on.



Under remote control status, all operations on electronic load are controlled by remote controller. The electronic load will return to local control after receiving the return command (SYST:LOCa).

Or you can return the electronic load to local control by pressing  key +  key.

4.2 Main Operation on the Front Panel

- Connecting to the power supply
- Turning the Input On/Off
- CC mode
- CV mode
- CR mode
- CP mode
- Short circuit operation
- Continuous transient operation
- Pulsed transient operation
- Toggled transient operation
- List operation
- Battery discharge operation
- Saving and recalling parameters
- Clear protection settings
- Error messages
- Triggered operation
- Main menu

4.3 Connecting to the Power Supply







Connect the positive pole of the power supply to the INPUT + terminal, and connect the negative pole of the power supply to the INPUT - terminal. If the input is connected reversely, the RV protection status of the load will become effective. In this case, disconnect the power supply from the load and then make the correct connections. After the power supply is correctly connected to the load, press  key +  key to clear the RV protection status or restart the load. The relevant details will be described in “Clearing Protection Settings”.

4.4 Turning the Input On/Off

Press  key to turn on or turn off the input.

4.5 Basic Operation

The operating procedures for basic tests are shown below:

- 1 Press  key to enter into mode selection and parameter setting menu.
- 2 Use  and  keys to select one operating mode.
- 3 Use Entry keys, or use the knob together with   keys to input set value.  key may be used to clear the values entered at present, or exit mode selection and parameter setting menu.
- 4 Press the **Enter** key to confirm and exit mode selection and parameter setting menu.
- 5 Press the  key to turn on the load's input.

4.5.1 CC Mode

Constant current mode has two ranges, the high range (CCH) and the low range (CCL).

Example 1: In CV mode, set the load to CCH, the current to 5.12 A and turn on the load.

The operating procedures are shown below:

Procedure	Operation Description	Display
1	Press the Set key to enter into the mode selection and parameter setting menu (e.g: the load is in CV mode).	MODE : CV VOLT : 80.00V
2	Use ▲ or ▼ key to select CCH mode.	MODE : CCH CURR : 0.00A
3	Use Entry keys, or use the knob together with the ◀ ▶ cursor keys to input the current value to 5.12.	MODE : CCH CURR : 5.120A
4	Press the Enter key to confirm and exit mode selection and parameter setting menu.	0.000V 0.000A 5.120A CCH OFF
5	Press the Input on/off key to turn on the load.	0.000V 0.000A 5.120A CCH ON
6	Use the ▲ and ▼ key to check the power value	

For the above operating procedures, the corresponding SCPI commands should be:

MODE	CCH	Sets the mode
CURR	5,12	Sets the current value
INPUT	ON	Turns on the load

Example 2: Current setting is 5.8A in CCH.

Switch on the load. The current setpoint can be set in two ways:

Option 1:

Procedure	Operation Description	Display
1	Press the Set key to enter into the mode selection and parameter setting menu.	MODE : CCH CURR : 5.120A
2	Use Entry keys, or use the knob together with the ◀ ▶ keys to input the current value to 5.8.	MODE : CCH CURR : 5.800A
3	Press the Enter key to confirm and exit the mode selection and parameter setting menu.	0.000V 0.000A 5.800A CCH OFF
4	Press the Input on/off key to turn on the load.	0.000V 0.000A 5.800A CCH ON

Option2:

Procedure	Operation Description	Display
1	Move the ◀ cursor to the hundredths with key.	0.000V 0.000A 5.120A CCH OFF
2	Rotate the knob to set the hundredths to 0. (Rotating the knob will change the set value immediately. And when the load is powered on, the new set value will become valid at the input terminal at once.)	0.000V 0.000A 5.100A CCH OFF
3	Move the cursor to the tenths with the ◀ key.	0.000V 0.000A 5.100A CCH OFF
4	Rotate the knob to set the tenths to 8. (Rotating the knob will change the set value immediately. And when the load is powered on, the new sett value will become valid in the input terminal at once.)	0.000V 0.000A 5.800A CCH OFF
5	Press the Input on/off key to turn on the load.	0.000V 0.000A 5.800A CCH ON

For the above operating procedures, the corresponding SCPI commands should be:

MODE	CCH	Sets the mode
CURR	5,8	Sets the current value
INPUT	ON	Turns on the load



Note

In CCH status or CCL status, CCH /CCL will be shown respectively in the lower right corner of the display.

4.5.2 CV Mode

Example 1: Set the load to CV mode and the voltage value to 50 V in CCH.

Then turn on the load, and check the present power value. The operating procedures are shown below:

Procedure	Operation Description	Display
1	Press the Set key to enter into the mode selection and parameter setting menu.	MODE : CCH CURR : 3.800A
2	Use the ▼ key to select CV mode.	MODE : CV VOLT : 80.000V
3	Use Entry keys or use the knob together with the ◀ ▶ cursor keys to input the voltage value to 50.	MODE : CV VOLT : 50.000V
4	Press the Enter key to confirm and exit the mode selection and parameter setting menu.	0.000V 0.000A 50.000V CV OFF
5	Press the Input on/off key to turn on the load.	0.000V 0.000A 50.000V CV ON
6	Check the present power value with the ▲ and ▼ keys.	0.000V 0.000A 50.000V 0.000W

For the above operating procedures, the corresponding SCPI commands should be:

MODE	CV	Sets the mode
VOLT	50	Sets the voltage value
INPUT	ON	Turns on the load

Example 2: Set the voltage value to 60 V in CV mode.

Turn on the load, and there are two ways to set the voltage value.

Option 1:

Procedure	Operation Description	Display
1	Press the Set key to enter into the mode selection and parameter setting menu.	MODE : CV VOLT : 50.000V
2	Use Entry keys or the knob together with the ◀ ▶ keys to input the voltage setpoint value to 60.	MODE : CV VOLT : 60.000V
3	Press the Enter key to confirm and exit the mode selection and parameter setting menu.	0.000V 0.000A 60.000V CV OFF
4	Press the Input on/off key to turn on the load.	0.000V 0.000A 60.000V CV ON

Option 2:

Procedure	Operation Description	Display
1	Move the cursor to the tens with key ◀.	0.000V 0.000A 50.000V CV ON
2	Rotate the knob to set the tens to 6. (Rotating the knob will change the set value immediately. The set value will become effective as soon as the power input is active.)	0.000V 0.000A 60.000V CV OFF
3	Press the Input on/off key to turn on the load.	0.000V 0.000A 60.000V CV ON

For the above operating procedures, the corresponding SCPI commands should be:

MODE	CV	Sets the mode
VOLT	60	Sets the voltage value
INPUT	ON	Turns on the load



Note

CV will be shown in the lower right corner of the display when the load is in CV mode.

4.5.3 CR Mode

CR Mode includes constant resistance low range (CRL), constant resistance medium range (CRM), and constant resistance high range (CRH).

Example 1: Set the load to CRL and set the resistance value to 1.5 Ω in CV mode.

Turn on the load, and check the present power value. The operating procedures are shown below:

Procedure	Operation Description	Display
1	Press Set key to enter into the mode selection and parameter setting menu.	MODE : CV VOLT : 50.000V
2	Use ▼ key to select CRL.	MODE : CRL RES : 0.0200Ω
3	Use Entry keys or the knob together with ◀ ▶ keys to input the resistance value to 1.5.	MODE : CRL RES : 1.5000Ω
4	Press the Enter key to confirm and exit the mode selection and parameter setting menu.	0.000V 0.000A 1.5000Ω CRL OFF
5	Press the Input on/off key to turn on the load.	0.000V 0.000A 1.5000Ω CRL ON
6	Check the present power value with ▲ and ▼ .	0.000V 0.000A 1.5000Ω 0.000W

For the above operating procedures, the corresponding SCPI commands should be:

MODE	CRL	Sets the mode
RES	1,5	Sets the resistance value
INPUT	ON	Turns on the load

Example 2: Set the resistance value to 1.8 Ω in CRL.

Turn on the load, and there are two ways to set the resistance value.

Option 1:

Procedure	Operation Description	Display
1	Press the Set key to enter into the mode selection and parameter setting menu.	MODE : CRL RES : 1.5000Ω
2	Use Entry keys or the knob together with the ◀ ▶ keys to input the resistance value to 1.8.	MODE : CRL RES : 1.8000Ω
3	Press the Enter key to confirm and exit the mode selection and parameter setting menu.	0.000V 0.000A 1.8000Ω CRL OFF
4	Press the Input on/off key to turn on the load.	0.000V 0.000A 1.8000Ω CRL ON

Option 2:

Procedure	Operation Description	Display
1	Move the cursor to the tenths with key ◀ .	0.000V 0.000A 1.5 <u>0</u> 00Ω CRL OFF
2	Rotate the knob to set the tenths to 8. (Rotating the knob will change the set value immediately. The set value will become effective at input at once when the load is turned on.)	0.000V 0.000A 1.8 <u>0</u> 00Ω CRL OFF
3	Press the Input on/off key to turn on the load.	0.000V 0.000A 1.8 <u>0</u> 00Ω CRL ON

For the above operating procedures, the corresponding SCPI commands should be:

MODE	CRL	Sets the mode
RES	1,8	Sets the resistance value
INPUT	ON	Turns on the load



Note

CRH /CRM/CRL will be shown respectively in the lower right corner of the display when the load is in CRH status, CRM status or CCL status.

4.5.4 CP Mode

CP Mode includes constant power-current source mode (CPC) and constant power-voltage source mode (CPV).

Example 1: Set the load to CPV and set the power value to 100 W.

Turn on the load, and check the present power value. The operating procedures are shown below:

Procedure	Operation Description	Display
1	Press the Set key to enter into the mode selection and parameter setting menu.	MODE : CRL RES : 1.800QΩ
2	Use the ▼ key to select CPV.	MODE : CPV POWR : 0.00QW
3	Use Entry keys or the knob together with ◀ ▶ keys to input the power value to 100.	MODE : CPV POWR : 100.00W
4	Press the Enter key to confirm and exit the mode selection and parameter setting menu.	0.000V 0.000A 100.0QW CPV OFF
5	Press the Input on/off key to turn on the load.	0.000V 0.000A 100.0QW CPV ON
6	Check the present power value with ▲ and ▼.	0.000V 0.000A 100.0QW 0.000W

For the above operating procedures, the corresponding SCPI commands should be:

MODE	CPV	Sets the mode
POW	100	Sets the power value
INPUT	ON	Turns on the load

Example 2: Set the power value to 200 W in CPV mode.

Turn on the load, and there are two ways to set the power value.

Option 1:

Procedure	Operation Description	Display
1	Press Set key to enter into the mode selection and parameter setting menu.	MODE : CPV POWR : 100.0QW
2	Use Entry keys or the knob together with ◀ ▶ keys to input the power value to 200.	MODE : CPV POWR : 200.00W
3	Press the Enter key to confirm and exit the mode selection and parameter setting menu.	0.000V 0.000A 200.0QW CPV OFF
4	Press the Input on/off key to turn on the load.	0.000V 0.000A 200.0QW CPV ON

Option 2:

Procedure	Operation Description	Display
1	Move the cursor to the hundredths with key ◀.	0.000V 0.000A 100.00W CPV OFF
2	Rotate the knob to set the hundredths to 2. (Rotating the knob will change the set value immediately. The set value will become effective at input at once when the load is turned on.)	0.000V 0.000A 200.00W CPV OFF
3	Press the Input on/off key to turn on the load.	0.000V 0.000A 200.00W CPV ON

For the above operating procedures, the corresponding SCPI commands should be:

MODE CPV	Sets the mode
POW 200	Sets the power value
INPUT ON	Turns on the load



Note

CPV /CPC will be shown respectively in the lower right corner of the display when the load is in CPV or CPC mode

4.6 Short Circuit Operation

The operating procedures for short circuit operation are shown below:

Example 1: The load was in CV mode previously and it is turned off. Set the load to short circuit in CCH status. Turn on the load to execute short circuit operation.

Procedure	Description	Display
1	Press the Menu key to enter into main menu, and select Short (short circuit) item with the ▼ key.	Short : On *Off
2	Use the ◀ key or knob to set On, and press the Enter key to confirm.	Short : On *Off
3	Press the Clear key to exit the main menu. The display shows "s" to indicate in the basic test mode.	0.000V 0.000A 0.000V sCV OFF
4	Press the Set key to enter into the mode selection and parameter setting menu; use ▲ and ▼ keys to select one basic operating mode; press the Enter key to confirm and exit the mode selection and parameter setting menu.	0.000V 0.000A 44.000A sCCH OFF
5	Press the Input on/off key to turn on the load.	0.000V 0.000A 44.000A sCCH ON

For the above operating procedures, the corresponding SCPI commands should be:

```
INPUT:SHORT    ON        Sets the load to short circuit operation
MODE            CCH        Sets the mode
INPUT            ON        Turns on the load
```

Example 2: Based on the last example, exit the short circuit operation, and turn off the load.

Procedure	Description	Display
1	Press the Menu key to enter into main menu, and select Short (short circuit) item with the ▲ key.	Short : On *Off
2	Use the ◀ key or knob to set Off, and press the Enter key to confirm.	Short : On *Off
3	Press the Clear key to exit the main menu. On the display, "s" disappears in CCH status.	0.000V 0.000A 0.000A CCH ON
4	Press the Input on/off key to turn off the load.	0.000V 0.000A 0.000A CCH OFF

For the above operating procedures, the corresponding SCPI commands should be:

```
INPUT:SHORT    OFF        Sets the load to exit the short circuit
INPUT            ON        Turns on the load
```

4.7 Transient Operation

The operating procedures for transient operation are shown below:

- 1 Press the **Set** key to enter into the mode selection and parameter setting menu; use ▲ and ▼ keys to select one basic operating mode; press the **Enter** key to confirm and exit the mode selection and parameter setting menu.
- 2 Press the **Tran** key to enter into transient operation. The display shows "t" to indicate in the basic test mode.
- 3 Press the **Set** key to enter into the transient operation menu.
- 4 Use ▲ and ▼ keys to select the parameter: LevelL, LevelH, TimeL, TimeH, TimeR und TimeF
- 5 Use Entry keys or use the knob together with ◀ ▶ keys to set values for LevelL, LevelH, TimeL, TimeH, TimeR, and TimeF. Use ◀ ▶ keys or knob to set Mode value: continuous, pulsed or toggled operation.
- 6 Press the **Clear** key to exit the transient operation menu.
- 7 Press the **Input on/off** key to turn on the load.
- 8 If it is the pulsed transient operation or the toggled transient operation, one trigger occurs when pressing **2nd** key + **Trigger** key or the signal at the trigger input terminal (TRIG IN) is low level.

4.7.1 Continuous Transient Operation

In continuous transient operation, the load switches at defined intervals between high and low level.

Relevant parameters:

- low-Pegel (LevelL),
- high-Pegel (LevelH),
- low-Pegel-Zeit (TimeL),
- high-Pegel-Zeit (TimeH),
- time for rising edge (TimeR) and
- time for falling edge (TimeF).

Example 1: Set the load voltage value to periodically switch between 1 V and 5 V; set the time for rising edge (TimeR) to 10 ms; set high level time (TimeH) to 200 ms; set time for falling edge (TimeF) to 20 ms; set low level time (TimeL) to 400 ms, and the load is in continuous transient operation. The operating procedures are shown as below:







Procedure	Description	Display
1	Press the Set key to enter into the mode selection and parameter setting menu; use ▲ ▼ keys to select CV mode; press the Enter key to confirm and exit the mode selection and parameter setting menu.	0.000V 0.000A 0.00QV CV OFF
2	Press the Tran key to enter into transient operation. The display shows "t" to indicate in CV mode.	0.000V 0.000A 80.000V tCV OFF
3	Press the Set key to enter into the transient operation menu.	▶ LevelL: 80.000V LevelH: 80.000V
4	Use Entry keys or use the knob together with ◀ ▶ keys to set LevelL to 1, and press the Enter key to confirm.	LevelL: 1.000V ▶LevelH: 80.00QV
5	Use Entry keys or use the knob together with ◀ ▶ keys to set LevelH to 5, and press the Enter key to confirm.	▶TimeL : 530.00ms TimeH : 500.00ms
6	Use Entry keys or use the knob together with ◀ ▶ keys to set TimeL to 400 ms, and press the Enter key to confirm.	TimeL : 400.00ms ▶TimeH : 500.00ms
7	Use Entry keys or use the knob together with ◀ ▶ keys to set TimeH auf 200 ms, and press the Enter key to confirm. The menu will show the next item automatically.	▶TimeR: 100.00ms TimeF: 100.00ms
8	Use Entry keys or use the knob together with ◀ ▶ keys to set TimeR auf 10 ms, and press the Enter key to confirm.	TimeR: 10.00ms ▶TimeF: 100.00ms
9	Use Entry keys or use the knob together with ◀ ▶ keys to set TimeF auf 20 ms, and press the Enter key to confirm.	▶Mode: ◀ Cont ▶
10	Betätigen Sie die Taste ◀ ▶ bzw. den Drehgeber, um Cont zu setzen und bestätigen Sie mit Enter .	▶Mode: ◀ Cont ▶
11	Use Clear keys or knob to set Mode value to Cont, and press key to confirm.	0.000V 0.000A 1.000V tCV OFF
12	Press the Input on/off key to turn on the load.	0.000V 0.000A 1.000V tCV ON 0.000V 0.000A 5.000V tCV ON

For the above operating procedures, the corresponding SCPI commands should be:

MODE	CV	Sets the mode
TRAN	ON	Enables the transient operation
VOLT:LLEV	1	Sets a value to low level
VOLT:HLEV	5	Sets a value to high level
TRAN:LTIME	400 ms	Sets a value to low level time
TRAN:HTIME	200 ms	Sets a value to high level time
TRAN:RTIME	10 ms	Sets a value to time for rising edge
TRAN:FTIME	20 ms	Sets a value to time for falling edge
TRAN:MODE	CONT	Selects continuous transient operation
INPUT	ON	Turns on the load

4.7.2 Pulsed Transient Operation

Example 1: Assume that the load is in external triggering mode, set the load current value to periodically switch between 1 A and 5 A; set the time for rising edge (TimeR) to 10 ms; set high level time (TimeH) to 200 ms; set time for falling edge (TimeF) to 10 ms; the load is in pulsed transient operation, and a trigger occurs at this time.

Procedure	Description	Display
1	Press the  key to enter into the mode selection and parameter setting menu; use the ▲ ▼ keys to select CCH mode; press the Enter key to confirm and exit the mode selection and parameter setting menu.	0.000V 0.000A 0.000A CCH OFF
2	Press the Tran key to enter into transient operation. The display shows “t” to indicate in CCH status.	0.000V 0.000A 0.500A tCCH
3	Press the  key to enter into the transient operation menu.	► LevelL: 0.500A LevelH: 1.000A
4	Use Entry keys or use the knob together with ◀ ▶ keys to set LevelL to 1, and press the Enter key to confirm.	LevelL: 1.000A ► LevelH: 1.000A
5	Use Entry keys or use the knob together with ◀ ▶ keys to set LevelH to 5, and press the Enter key to confirm.	► TimeL: 400.00ms TimeH: 400.00ms
6	Press the ▼ key to select TimeH; use Entry keys or use the knob together with ◀ ▶ keys to set TimeH to 200 ms, and press the Enter key to confirm.	► TimeR: 10.00ms TimeF: 20.00ms
7	Use Entry keys or use the knob together with ◀ ▶ keys to set TimeR to 10 ms, and press the Enter key to confirm.	TimeR: 10.00ms ► TimeF: 20.00ms
8	Use Entry keys or use the knob together with ◀ ▶ keys to set TimeF to 10 ms, and press the Enter key to confirm.	► Mode: ◀ Cont ▶
9	Use the ◀ ▶ keys or knob to set Mode value to pulse , and press the Enter key to confirm.	► Mode: ◀ Puls ▶
10	Press the  key to exit the transient operation menu.	0.000V 0.000A 1.000A tCCH OFF
11	Press the  key to turn on the load.	0.000V 0.000A 1.000A tCCH ON
12	One trigger occurs when pressing  +  key or the signal at the trigger input terminal (TRIG IN) is low level.	0.000V 0.000A 5.000A tCCH ON

For the above operating procedures, the corresponding SCPI commands should be:







```

MODE          CCH      Sets the mode
TRAN          ON       Enables the transient operation
CURR:LLEV    1         Sets a value to low level
CURR:HLEV    5         Sets a value to high level
TRAN:HTIME   200ms    Sets a value to high level time
TRAN:RTIME   10us     Sets a value to time for rising edge
TRAN:FTIME   10us     Sets a value to time for falling edge
TRAN:MODE    PULS     Selects pulsed transient operation
INPUT        ON       Turns on the load
.
.
Trig                    One trigger occurs

```

4.7.3 Toggled Transient Operation

Example 1: Assume that the load is in external triggering mode, set the load resistance value to periodically switch between 200 Ω and 500 Ω; set the time for rising edge (TimeR) to 10 ms; set time for falling edge (TimeF) to 10 ms; the load is in toggled transient operation, and a trigger occurs at this time.

Procedure	Description	Display
1	Press the  key to enter into the mode selection and parameter setting menu; use the ▲ ▼ keys to select CRH mode; press the Enter key to confirm and exit the mode selection and parameter setting menu.	0.000V 0.000A 20.000Ω CRH OFF
2	Press the Tran key to enter into transient operation. The display shows "t" to indicate in CRH status.	0.000V 0.000A 2000.0Ω tCRH OFF
3	Press the  key to enter into the transient operation menu.	►LevelL: 2000.0Ω LevelH: 2000.0Ω
4	Use Entry keys or use the knob together with ◀ ▶ keys to set LevelL to 200, and press the Enter key to confirm.	LevelL: 200.00Ω ►LevelH: 2000.0Ω
5	Use the Entry keys or the knob together with ◀ ▶ keys to set LevelH to 500, and press Enter key to confirm.	►TimeL: 400.00ms TimeH: 200.00ms
6	Press the ▼ key to select TimeR; Use the Entry keys or the knob together with ◀ ▶ keys to set TimeR to 10 ms, and press the Enter key to confirm.	TimeR: 10.00ms ►TimeF: 10.00ms
7	Use the Entry keys or the knob together with ◀ ▶ keys to set TimeF to 10 ms, and press Enter key to confirm.	►Mode: ◀ Puls ▶
8	Use ◀ ▶ keys or knob to set Mode value to Togg, and press the Enter key to confirm.	►Mode: ◀ Togg ▶
9	Press the  key to exit the transient operation menu.	0.000V 0.000A 200.00Ω tCRH OFF
10	Press the  key to turn on the load.	0.000V 0.000A 200.00Ω tCRH
11	One trigger occurs when pressing  +  key or the signal at the trigger input terminal (TRIG IN) is low level.	0.000V 0.000A 500.00Ω tCRH ON

For the above operating procedures, the corresponding SCPI commands should be:







```

MODE          CRH      Sets the mode
TRAN          ON       Enables the transient operation
RES:LLEV     200       Sets a value to low level
RES:HLEV     500       Sets a value to high level
TRAN:RTIME   10us     Sets a value to time for rising edge
TRAN:FTIME   10us     Sets a value to time for falling edge
TRAN:MODE    TOGG     Selects toggled operation
INPUT        ON       Turns on the load
.
.
Trig                    One trigger occurs













```

4.8 Sequence Operation (List)

The operating procedures for enabling/disabling sequence (list) operation are shown below:

- 1 Press the  key +  the key to enter into sequence (list) operation menu.
- 2 Use Entry keys or the knob to select list number (No.), and press the **Enter** key to confirm.
- 3 Use the  key to quit the sequence operation menu.
- 4 Use the  and  keys to activate the sequence (list) operation.
- 5 Use the  and  keys to stop the sequence (list) operation.









The operating procedures for setting the sequence (list) parameters are shown below:

- 1 Press the  key + the  key to enter into sequence (list) operation menu.
- 2 Use the Entry keys or the knob to select list number (No.), and press the **Enter** key to confirm.
- 3 Use the ▼ key to select list memo (Memo).
- 4 Use knob and the ◀ ▶ keys to edit memo (max. 10 characters).
- 5 Use the ▼ key to select sequence data (Data:<New/Edit>).
- 6 Use ◀ ▶ keys or knob to select New or Edit operation, and press the **Enter** key to confirm.
- 7 Use ◀ ▶ to select parameters.
- 8 Use Entry keys or use the knob together with ◀ ▶ keys to input set value; or use the knob/ key to select one operating mode, and press the **Enter** key to confirm. After setting the third parameter, press the **Enter** key to confirm and enter into the next step.
- 9 If it is needed to modify one step, use ▲ and ▼ keys to select this step. The setting operations for this step are the same as described under item 8.
- 10 If it is needed to add one step to the last step, use the ▼ key to select the new step. The setting operations for this new step are the same as described under item 9.
- 11 If it is needed to insert one step above an edited step, use ▲ and ▼ keys to select this edited step. The LCD display doesn't flash at this time, and press  key +  key to insert a new step.
The setting operations for this new step are the same as described under item 8.
- 12 If it is needed to delete an edited step, use the ▲ and ▼ keys to select this step. The LCD display will stop flashing, and press the  key +  key to delete. If there is only one step exists, it will exit the step edit screen.
- 13 Press the  key to exit step edit screen, and save the sequence data in EEPROM assigned by the sequence number.
- 14 Use the ▼ key to select the cycle times (Count); use Entry keys or the knob together with ◀ ▶ keys to input set value. Press the **Enter** key to confirm and save the cycle times (Count) in EEPROM assigned by the sequence number.
- 15 Use the ▼ key to select "Chain"; use Entry keys (the "Chain" is OFF when the Entry key exceeds 6) or the knob to input the set value. Press the **Enter** key to confirm.
- 16 Press the  key to exit sequence operation menu.
- 17 Press the  key +  key to activate sequence operation.
- 18 Press the  key +  key to stop sequence operation.

4.8.1 Sequence (List) editing

Example 1: Edit a new sequence. The sequence number is 0; the sequence Memo is Test Power; the sequence steps: step 1: CCL, 1 A, 1 S; step 2: CCH, 2 A, 1S; step 3: CV, 1 V, 1 S; step 4: CRL, 1 Ω , 1 S; step 5: CRH, 200 Ω , 1 S.

The cycle times (Count) for sequence operation is 5; disabling the sequence chain; starting sequence operation; stopping sequence operation.









Procedure	Description	Display
1	Press the  key +  key to enter into sequence (list) operation menu.	▶ No.: 0 Memo
2	Use Entry keys or the knob to set the sequence number (No.) to 0, and press the Enter key to confirm. (Recall the sequence in EEPROM assigned by the sequence number).	▶ No.: 0 Memo
3	Use the ▼ key to select sequence memo (Memo).	▶ No.: 0 Memo
4	Rotate the knob to select the letter "T".	▶ No.: 0 Memo T
5	Use the ▶ key to move the cursor to the right.	▶ No.: 0 Memo: T
6	Rotate the knob to select the letter "e".	No.: 0 ▶ Memo: Te
7	Set Memo to "Test Power" according to step 5 and step 6 operations. Press the Enter key to confirm.	No.: 0 ▶ Memo: Test Power
8	Use the ▼ key to select Data:<New/Edit>.	▶ Data:<New/Edit> Count: 1
9	Use the ◀ key or knob to select New, and press Enter key to confirm.	Clear Data: Yes *No
10	Use the ◀ key or knob to select Yes, and press the Enter key to confirm. The data is cleared and step edit screen appears.	01. 0.0000qs CC 0.000A
11	Edit the step 1: CCL, 1 A, 1 S. The time set value in the upper right corner of the display flashes. Use the Entry keys or the knob together with ◀ ▶ keys to input time to 1 s, and press the Enter key to confirm.	01. 1.0000qs CCH 0.000A
12	The basic mode showed in lower left corner of the display flashes. Use the knob or  key to select operating mode to CCL, and press the Enter key to confirm.	01. 1.0000qs CCL 0.000A
13	The set value in the lower right corner of the display flashes. Use Entry keys or the knob together with the ◀ ▶ keys to input the current value to 1 A. Press the Enter key to confirm and enter into the next operation.	01. 1.0000qs CCL 1.000A
14	Repeat the procedures 11 through 13 to set the rest four steps.	
15	The five sequence steps have been edited, and there is no need to edit step 6. Press the Clear key to exit step edit screen and save the sequence data in EEPROM assigned by the sequence number.	06. 0.0000qs CRH 20.000 Ω
16	Use the ▼ key to select "Count"; use Entry keys or the knob together with the ◀ ▶ keys to input "5". Press the Enter key to confirm and save the Count value in EEPROM assigned by the sequence number.	Data:<New/Edit> ▶ Count: 5
17	Use the ▼ key to select "Chain"; use the Entry keys (the "Chain" is OFF when the Entry key exceeds 6) or the knob to input "Off". Press the Enter key to confirm and save the Chain value in the EEPROM assigned by the sequence number.	▶ Chain: Off
18	Press the  key to exit sequence operation menu.	0.000V 0.000A 0.000A CCH OFF
19	Press the  key +  key to activate sequence operation.	0.000V 0.0000A 1.000A LCCL ON
20	Press the  key +  key to deactivate sequence operation.	0.000V 0.000A 0.000A CCH OFF

For the above operating procedures, the corresponding SCPI commands should be:

LIST:RECALL	0	Recalls the number 0 sequence
LIST:MEMO	Test Power	Sequence memo is "Test Power"
LIST:DATA	CCL,1A,1S	
LIST:DATA	CCH,2A,1S	
LIST:DATA	CV,1V,1S	
LIST:DATA	CRL,1 Ω ,1S	
LIST:DATA	CRH,200 Ω ,1S	The above 5 commands are sequence steps
LIST:COUNT	5	Cycle times for this sequence
LIST:CHAIN	OFF	Disables the chained sequence
LIST	ON	Activates sequence operation
LIST	OFF	Stops sequence operation

4.8.2 Modifying, Adding, Inserting, Deleting Sequences

Exempel 1: Based on the example 1 in section 4.8.1, step 1 modifies the time to 2 s. Add “CCH, 5 A, 1S” to the last step. Insert “CRL , 1 Ω, 10 S” at step 3. Delete step 2. The sequence is chained to itself to realize the continuous execution.

Steps	Description	Display
Step 1	Press the  key +  key to enter into sequence operation menu.	►No.: 0 Memo: Test Power
Step 2	Use the ▼ key to select Data:<New/Edit>.	►Data:<New/Edit> Count: 5
Step 3	Use the ► key or knob to select Edit, and press the Enter key to confirm and enter step edit screen.	01. 1.0000s CCL 1.0000A
Step 4	Use the ► key to select time parameter, and the time set value flashes.	01. 1.0000s CCL 1.0000A
Step 5	Use the Entry keys or the knob together with ◀ ► keys to input the time to 2 s, and press the Enter key to confirm.	01. 2.0000s CCL 1.0000A
Step 6	Use the ▼ key to select the last new step (Step6).	06. 0.0000s CRH 20.000Ω
Step 7	Add a new step: CCH, 5 A, 1 S. The set value in the upper right corner of the display flashes. Use Entry keys or the knob together with ◀ ► keys to input time to 1 s, and press the Enter key to confirm.	06. 1.0000s CRH 20.000Ω
Step 8	The basic mode showed in lower left corner of the display flashes. Use the knob or the  key to select operating mode to CCH, and press the Enter key to confirm.	06. 1.0000s CCH 0.000A
Step 9	The set value in the lower right corner of the display flashes. Use Entry keys or the knob together with the ◀ ► keys to input the current value to 5 A. Press the Enter key to confirm and enter into the next operation.	06. 1.0000s CCH 5.000A
Step 10	Use the ▲ key to select the step 3.	07. 0.0000s CCH 0.000A
Step 11	Press the  key +  key to insert a new step at step 3.	03. 1.0000s CV 1.000V
Step 12	Insert a new step: CRL, 1 Ω, 10 S at step 3. The setting operations for this new step are the same as described under items 7 to 9.	03. 0.0000s CV 0.000V
Step 13	Use the ▲ key to select the step 2.	03. 10.0000s CRL 1.0000Ω
Step 14	Press the  key +  key to delete the step 2.	02. 1.0000s CCH 2.000A
Step 15	Press the  key to exit step edit screen and save the sequence data in EEPROM assigned by the sequence number.	02. 10.000s CRL 1.0000Ω
Step 16	Use the ▼ key to select Chain.	►Data:<New/Edit> Count: 5
Step 17	Use Entry keys or the knob to input 0 (it is chained to itself to realize continuous execution). Press the Enter key to confirm and save the Chain value in EEPROM assigned by the sequence number.	►Chain: Off
Step 18	Press the  key to exit sequence operation menu.	►Chain: 0
		0.000V 0.000A 0.000A CCH OFF

4.8.3 Starting/Stopping the List

Example 1: Start the No.0 sequence, and stop the active sequence operation.

Steps	Description	Display
Step 1	Press 2nd and 9 key to enter into sequence operation menu.	▶ No.: 1 Memo:
Step 2	Use Entry keys or knob to set the sequence number (No.) to 0, and press the Enter key to confirm (recall the sequence in EEPROM assigned by the sequence number).	▶ No.: 0 Memo: Test Power
Step 3	Press the Clear key to exit sequence operation menu.	0.000V 0.000A 0.000A CCH OFF
Step 4	Press the 2nd key + 4 key to activate sequence operation.	0.000V 0.0000A 1.0000A LCCL ON
Step 5	Press the 2nd key + 5 key to stop sequence operation.	0.000V 0.000A 0.000A CCH OFF

For the above steps, the corresponding SCPI commands should be:

```
LIST:RECALL 0 Recalls the number 0 sequence
LIST ON Starts sequence operation
LIST OFF Stops sequence operation
```

4.9 Battery Discharge Operation

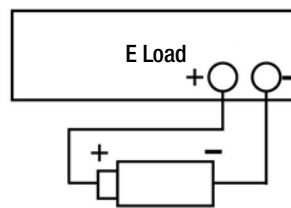















Figure 1.1 Battery discharge operation diagram

The operating procedures for battery discharge operation are shown below:

- 1 Press the **Input on/off** key to turn off the load, and connect the tested battery correctly.
- 2 Press the **2nd** key + **6** key to enter into battery discharge operation screen.
- 3 Press the **Set** key to enter into battery discharge parameters edit screen. Use ▲ and ▼ keys to select the parameter. Use the Entry keys or the knob together with ◀ ▶ keys to input termination voltage value and discharge current value. Press the **Enter** key to confirm.
- 4 Press the **Clear** key to exit the battery discharge parameters edit screen.
- 5 Press the **Input on/off** key to turn on the load, and start battery discharge operation.
- 6 Press the **Input on/off** key to turn off the load, and stop battery discharge operation.
- 7 Press the **Clear** key to clear the discharge time and discharge capacity of the battery.
- 8 Press the **2nd** key + **6** key to exit the battery discharge operation.

Example 1: Enter into the battery discharge operation; set the termination voltage to 15 V, and the discharge current to 3 A; turn on the load, and start the battery discharge operation; turn off the load and stop the battery discharge operation; clear the discharged time and discharged capacity of the battery; exit the battery discharge operation.

Steps	Description	Display
Step 1	Press the  key to turn off the load, and connect the tested battery correctly.	20.000V 0.000A 0.000A CCH OFF
Step 2	Press the  key +  key to enter into battery discharge operation screen.	20.000V 0.000A 0.000AH 00:00:00
Step 3	Press the  key to enter into battery discharge parameters edit screen. Use the Entry keys or the knob together with the   keys to set termination voltage to 15 V. Press the Enter key to confirm.	▶MinVolt:0.000V DisCurr:2.000A
Step 4	Use the Entry keys or the knob together with   keys to set discharge current to 3 A. Press the Enter key to confirm.	MinVolt:15.000V ▶DisCurr:3.000A
Step 5	Press the  key to exit the battery discharge parameters edit screen.	20.000V 0.000A 0.000AH 00:00:00
Step 6	Press the  key to turn on the load, and start battery discharge operation.	20.000V 3.000A 0.000AH 00:00:01
Step 7	Press the  key to turn off the load, and stop battery discharge operation.	20.000V 0.000A 0.012AH 00:00:15
Step 8	Press the  key to clear the discharged time and discharged capacity of the battery.	20.000V 0.000A 0.000AH 00:00:00
Step 9	Press the  key +  key to exit the battery discharge operation.	20.000V 0.000A 0.000A CCH OFF

For the above operating procedures, the corresponding SCPI commands should be:





```

INPUT          OFF  Turns off the load
BATTERY        ON   Activates the battery discharge operation screen
BATT:VOLT:OFF  15V  Sets termination voltage to 15V
BATT:DIS:CURR  3A   Sets discharge current to 3A
INPUT          ON   Turns on the load, and start battery discharge operation
INPUT          OFF  Turns off the load, and stop battery discharge operation
operationBATTERY OFF Exits the battery discharge operation



```

4.10 Saving and Recalling

The operating procedures for saving and recalling operation are shown below:

- 1 Press the  key +  key to enter into the saving menu, or press the  key +  key to enter into the recalling menu.
- 2 Press the Entry keys or the knob to select saving or recalling position.
- 3 Press the **Enter** key to confirm and exit the saving or recalling menu. If the saving is selected, the values of the 2-1 parameters will be saved in the specified location (0-9) in EEPROM; if the recalling is selected, the values of the parameters should be the values saved in specified location in EEPROM.

Example 1: Set the mode to CCL; set the current value to 2 A; turn on the load; save the settings in Location 0 in EEPROM; the next time the load is turned on, these settings will become the power-on settings.

Procedure	Description	Display
1	Set the mode to CCL; set the current value to 2 A; turn on the load.	0.000V 0.000A 2.0000A CCL ON
2	Press the  +  keys to enter into the saving menu.	Save File No. <u>1</u>
3	Press Entry keys or the knob to select the Location 0 for saving.	Save File No. <u>0</u>
4	Press the Enter key to confirm and exit the load saving menu.	0.000V 0.000A 2.0000A CCL ON



For the above operating procedures, the corresponding SCPI commands should be:

```

MODE          CCH   Sets the load to CCH status
CURR          2     Sets the current value to 2A
*SAV         0     Saves the present settings in Location 0 in EEPROM

```

Example 2: Based on the above example, set the mode to CV; set the voltage value to 40 V; turn off the load; recall the values saved in Location 0 in EEPROM. The detailed operations are shown below:



Procedure	Description	Display
1	Set the mode to CV; set the voltage value to 40 V; turn off the load(please refer to section 4.4 for detailed operations).	0.000V 0.000A 40.000V CV OFF
2	Press the  key +  key to enter into the recalling menu..	Recall File: No. <u>0</u>
3	Press the Entry keys or the knob to select the recalled Location 0.	Recall File: No. <u>0</u>
4	Press the Enter key to confirm and return to the previous menu.	0.000V 0.000A 2.0000A CCL ON

For the above operating procedures, the corresponding SCPI commands should be:



```
MODE            CV        Sets the CV mode
VOLT            40        Sets the voltage value to 40V
*RCL            0        Recalls the values saved in location 0 in EEPROM
```

4.11 Clearing Protection Settings

The operating procedures for clear protection settings are shown below:

- 1 Eliminate the reason that causes the protection status.
- 2 Press the  and  keys.

Example 1: Clear RV protection of the load. The detailed operations are shown below:

Procedure	Description	Display
1	Connect the power supply to the load again.	0.000V 0.0000A 2.0000A RV OFF
2	Press  and  keys.	0.000V 0.0000A 2.0000A CCL OFF

For the above operating procedures, the corresponding SCPI commands should be:

```
INP:PROT:CLE    S:        Clears the protection status
```



4.12 Error Messages

When an error occurs to the load, the operating procedures are shown below:

- 1 Press the  key +  key to display the error messages.

Example 1: When a wrong command is sent, the ERR indicator will turn red. Check the error message.

The detailed operations are shown below:

Procedure	Description	Display
1	Press the  key +  key to display the error message.	ERROR -103
2	If there are still errors that have not been examined, repeat the first operation.	
3	If all errors have been checked, the EER indicator will be turned off. If repeat the first operation right now, display will shows "NO ERROR".	NO ERROR

For the above operating procedures, the corresponding SCPI commands should be:

```
SYST:ERR?                    Queries the error code and error messages
```



Note

An overview of the individual error messages and the associated explanations are provided in the „SPL SCPI Programming Guide“ in Chapter 3.







4.13 Triggered Operation

When the triggering mode is EXTERNAL, the triggered operations are shown below:

- 1 Set pending trigger function (see section 2.8).
- 2 Press the  key +  key or trigger terminal (TRIG IN) to receive TTL falling edge, and a trigger occurs.

Example 1: Select "List" for the trigger function to trigger a sequence operation. The sequence is the one mentioned in Example 1 in section 4.8.1.

The detailed operations are shown below:



Steps	Description
Step 1	Select "List" in main menu for the trigger function (please see section 4.14.6 for detailed introduction).
Step 2	Press  key +  key or trigger terminal (TRIG IN) to receive TTL low level. The load's input will change accordingly when the sequence parameters are changed. Pressing  key +  key has the same effect as pressing  key +  key at this time.

For the above operating procedures, the corresponding SCPI commands should be:

TRIG:FUNC LIST Selects „LIST“ for trigger function
 TRIG A trigger occurs

4.14 Main Menu



The operating procedures for the main menu are shown below:

- 1 Press the  key to enter into the main menu.
- 2 Use ▲ and ▼ keys to select the menu item.
- 3 Use the knob or ◀ ▶ keys to select the parameter; or use Entry keys or the knob together with ◀ ▶ keys to input set value. Press  key to exit the parameter modification or exit the main menu.
- 4 Press the **Enter** key to confirm.
- 5 Press the  key to exit the main menu.

4.14.1 Loading Default Values

Example: Load the default values.





The detailed operations are shown below:

Procedure	Description	Display
1	Press the  key to enter into the main menu.	Load Default : Yes *No
2	Use the knob or ◀ key to select the parameter "Yes". Press the Enter key to confirm.	Load Default : *Yes No
3	Press the  key to exit the main menu.	

4.14.2 Short Circuit Operation

Example: Short circuit operation in CV mode. The detailed operations are shown below:

The detailed operations are shown below:



Procedure	Description	Display
1	Press the  key to enter into the main menu.	Load Default : Yes *No
2	Use the ▼ key to select the menu item "Short"; use the knob or ◀ key to select the parameter "On". Press the Enter key to confirm.	Short On *Off
3	Press the  key to exit the main menu.	
4	Press the  key to enter into the mode selection and parameter setting menu; use ▲ ▼ keys to select CV mode. Press the Enter key to confirm and exit the mode selection and parameter setting menu.	0.000V 0.000A 0.000V sCV OFF
5	Press the  key to turn on the load.	0.000V 0.000A 0.000V sCV ON

For the above operating procedures, the corresponding SCPI commands should be:

```
INPUT:SHORT      ON          Sets the load to short circuit
MODE              CV              Sets the mode
INPUT              ON              Turns on the load
```

4.14.3 Von Point/Von Latch

Example: Set the Von Latch to Off; set Von Point to 1 V; turn on the load; This example implements the automatic turning on/off of the load's input, which simplifies the test operations greatly. The detailed operations are shown below:

Procedure	Description	Display
1	Press the  key to enter into the main menu.	Load Default : Yes *No
2	Use the ▼ key to select the menu item "Von Latch"; use the knob or ▶ key to select the parameter "Off". Press the Enter key to confirm.	Von Latch : On *Off
3	Use the ▼ key to select the menu item "Von Point"; use Entry keys or the knob together with ▲ ▼ keys to input the voltage value. Press the Enter key to confirm.	Von Point : 1.00QV
4	Press the  key to exit the main menu.	0.000V 0.000A 0.000A CCH OFF
5	Press the  key to turn on the load.	0.000V 0.000A 0.000A CCH ON

For the above steps, the corresponding SCPI commands should be:

```
INP:VOLT:ON:LATCH      OFF      Disables the Von Latch
INP:VOLT:ON              1        Sets the Von voltage to 1 V
INPUT                      ON        Turns on the load
```

4.14.4 Current Limit in CV Mode

Example: Set the load to CV mode; set the voltage value to 2 V; set the current limit value in CV mode (CV Curr Limit) to 20 A; turn on the load. The detailed operations are shown below:

Procedure	Description	Display
1	Set the load to CV mode, and set the voltage value to 2 V (see section 4.5 for details).	0.000V 0.000A 2.000V CV OFF
Step2	Press the Menu key to enter into the main menu.	Load Default : Yes *No
Step3	Use the ▼ key to select the menu item "CV Curr Limit"; use Entry keys or the knob together with ◀ ▶ keys to input the current limit value to 20 A. Press the Enter key to confirm.	CV Curr Limit : 20.000A
Step4	Press the Clear key to exit the main menu.	0.000V 0.000A 2.000A CCH OFF
Step5	Press the Input on/off key to turn on the load.	0.000V 0.000A 2.000A CCH ON

For the above operating procedures, the corresponding SCPI commands should be:

```
MODE          CV   Sets the mode
VOLT          2   Sets the voltage setpoint to 2 V
CV:CURRE:LIM 20A  Sets the current limit value to 20 A in CV mode
INPUT        ON   Turns on the load
```

4.14.5 Current Rise/Fall Rate in CC Mode

Example: Set the load to CCH mode, set the current value to 2 A; set the current rise rate (Curr Rise Rate) in CC mode to 0.002 A/μs; set the current fall rate (Curr Fall Rate) in CC mode to 0.005 A/μs; turn on the load; turn off the load.

The detailed operations are shown below:



Procedure	Description	Display
1	Set the load to CCH mode, and set the current value to 2 A (see section 5.1 for details).	0.000V 0.000A 2.000A CCH OFF
2	Press the Menu key to enter into the main menu.	Load Default : Yes *No
3	Use the ▼ key to select the menu item "Curr Rise Rate"; use Entry keys or the knob together with ◀ ▶ keys to input the current value to 0.002 A/μs. Press the Enter key to confirm.	Curr Rise Rate : 0.002A/us
4	Use the ▼ key to select the menu item "Curr Fall Rate"; use Entry keys or the knob together with the ◀ ▶ keys to input the current value to 0.005 A/μs. Press the Enter key to confirm.	Curr Fall Rate : 0.005A/us
5	Press the Clear key to exit the main menu.	0.000V 0.000A 2.000A CCH OFF
6	Press the Input on/off key to turn on the load.	0.000V 0.000A 2.000A CCH ON
7	Press the Input on/off key to turn off the load.	0.000V 0.000A 2.000A CCH OFF

For the above operating procedures, the corresponding SCPI commands should be:

```
MODE          CCH  Sets the mode
CURR          2   Sets the current value to 2 A
CURR:RISE:RATE 0.002 Sets the current rise rate in CC mode to 0.002 A/μs
CURR:FALL:RATE 0.005 Sets the current fall rate in CC mode to 0.005 A/μs
INPUT        ON   Turns on the load
INPUT        OFF  Turns off the load
```

4.14.6 Trigger Function Selection

Example: Select „Tran“ in trigger function selection (Trig Function).



Procedure	Description	Display
1	Press the  key to enter into the main menu.	Load Default : Yes *No
2	Use the ▼ key to select the menu item “Trig Function”; use the knob or the ◀ key to select the parameter “Tran”. Press the Enter key to confirm.	Trig Function : *Tran List
3	Press the  key to exit the main menu.	0.000V 0.000A 0.00QA CCH OFF

For the above operating procedures, the corresponding SCPI commands should be:

TRIG:FUNC TRAN Selects transient operation (TRAN) for trigger function



4.14.7 Knob Function

Example: Enable the knob function.

Procedure	Description	Display
1	Press the  key to enter into the main menu.	Load Default : Yes *No
2	Use the ▼ key to select the menu item “Knob”; use the knob or the ◀ key to select the parameter “On”. Press the Enter key to confirm.	Knob : On *Off
3	Press the  key to exit the main menu.	0.000V 0.000A 0.00QA CCH OFF



4.14.8 Key Sound

Example: Enable the key sounds.



Procedure	Description	Display
1	Press the  key to enter into the main menu.	Load Default : Yes *No
2	Use the ▼ key to select the menu item “Key Sound”; use the knob or the ◀ key to select the parameter “On”. Press the Enter key to confirm.	Key Sound : On *Off
3	Press the  key to exit the main menu.	0.000V 0.000A 0.00QA CCH OFF

4.14.9 Communication Interface

Example 1: Select RS232 interface; set the baud rate to 9600; set parity check to None; set data bit to 8; set stop bit to 2; enable the flow control.

Steps	Description	Display
Step 1	Press the  key to enter into the main menu.	Load Default : Yes *No
Step 2	Use the ▼ key to select the menu item “Interface”; use the knob or the ◀ key to select the parameter “RS232”. Press the Enter key to confirm.	Interface : *RS232 GPIB
Step 3	Use the ▼ key to select the menu item “Baud Rate”; use the knob or the ◀ key to select the parameter “9600”. Press the Enter key to confirm.	Baud Rate : *9600 19200
Step 4	Use the ▼ key to select the menu item “Knob”; use the knob or the ◀ key to select the parameter “On”. Press the Enter key to confirm. Wählen Sie mit Hilfe der Taste ▼ den Menüpunkt „Parity Check“. Setzen Sie mit dem Drehgeber oder der Taste ◀ den Parameter auf „None“. Betätigen Sie die Taste Enter , um die Eingabe zu bestätigen.	Parity Check : *None Even Odd
Step 5	Use the ▼ key to select the menu item “Data Bit”; use the knob or the ◀ key to select the parameter “8”. Press the Enter key to confirm.	Data Bit : *8 7
Step 6	Use the ▼ key to select the menu item “Stop Bit”; use the knob or the ◀ key to select the parameter “2”. Press the Enter key to confirm.	Stop Bit : 1 *2
Step 7	Use the ▼ key to select the menu item “Flow Control”; use the knob or the ◀ key to select the parameter “On”. Press the Enter key to confirm.	Flow Control : On *Off
Step 8	Press the  key to exit the main menu.	0.000V 0.000A 0.00QA CCH OFF

Example 2: Select GPIB interface, set the address to 18.

Steps	Description	Display
Step 1	Press the  key to enter into the main menu.	Load Default : Yes *No
Step 2	Use the ▼ key to select the menu item “Interface”; use the knob or the ▶ key to select the parameter “GPIB”. Press the Enter key to confirm.	Interface : RS232 *GPIB
Step 3	Use the ▼ key to select the menu item “GPIB Address”; use Entry keys or the knob together with ◀ ▶ keys to select the parameter “18”. Press the Enter key to confirm.	GPIB-Adresse : 18
Step 4	Press the  key to exit the main menu.	0.000V 0.000A 0.00QA CCH OFF

5 Remote Programming Operation

SPL Series Electronic Load supports both local operation and remote control. The previous chapter has introduced how to use the front panel keys and knobs to operate on the load. This chapter will introduce you to how to program the load from the remote controller. The similarities between local and remote programming will become apparent as you read this chapter. The intent of this chapter is to help users quickly become familiar with remote programming operations. Programming examples given in this chapter use the SCPI commands in their simplest form. Please refer to the “SPL SCPI Programming Guide” for detailed introduction of all SCPI commands.

5.1 Communication Interface

5.1.1 RS232

RS232 interface is standard. Use the cable shipped with the load to connect the load to a computer correctly. Select RS232 interface in the MENU, and set the baud rate, parity, data bit, stop bit, and flow control parameters to be used. Set the same parameters in the software on the computer, and input the right SCPI command to operate the load.





5.1.2 GPIB

GPIB interface is optional. It can be used only when the load has installed GPIB communication module and the relevant driver has been installed on the computer. Use GPIB cable to connect the load to a computer correctly. Select the GPIB interface in the MENU, and set GPIB address. Each instrument you connect to the GPIB interface has a unique address assigned to it. Input the right SCPI command to operate the load.

5.2 Flow Control Selection

When RS232 interface is used, the flow control can be enabled or disabled. The load provides two options: ON and OFF. ON: enabling the flow control; OFF: disabling the flow control. When “OFF” is selected for flow control, the lower baud rate should be set to ensure normal communication.

5.3 Remote Control Indicator

There is a REM indicator on the front panel of the load. When the load receives the remote command (SYSTem:REMOte) via RS232 or GPIB interface, the REM annunciator turns on. And the load enters remote control status. In this status, all operations on the load are controlled by the remote controller; the front panel keypad and knob has no effect (except  key +  key). The REM remote control indicator turns off and the load returns to the local control after receiving the command to return to local control (e.g. SYSTem:LOCAl). Or you can return the load to local control from remote control by pressing the  key +  key.

5.4 Sending a Remote Command

You can use the computer to set operation mode and operation parameters remotely for the load.

5.5 Returning Data

The load can return the values of parameter settings, input voltage and current, as well as input power to computer. It can also return information relating to the internal operation and module identification. For example: the query command (“MEAS:CURRE?”) asks the load to return the actual current at the Input binding posts. Please refer to “SPL SCPI Programming Guide” for detailed information on using query commands. The load stores the response to the query in an output buffer which will hold the information until it is read by the computer or is replaced with new information.

5.6 Remote Programming Commands

The SCPI commands have many optional key words for the programmer. Getting familiar with those key words will help you to know the programming better. Most of the commands have a query syntax which allows the present parameter settings to be returned to the controller. Please refer to “SPL SCPI Programming Guide” for details. The load’s major functions can be programmed with a relatively few number of these commands. The following points are important to remember when you are remotely programming CC, CR, CV, and CP values.

5.6.1 Modes

The CC, CR, CV, and CP values can be programmed whether or not the associated mode is active. If the input is turned on, all of the applicable values will take effect at the input when the associated mode is selected.

5.6.2 Transient Levels

The transient CC, CV, or CR level must be set to a higher level than the respective low level, or the transient operation will be disabled.

5.6.3 Programmable Current Protection

When programmable current protection is enabled, and the programmed current limit and time delay are exceeded, the load's input will be turned off.

5.7 CC Mode Examples

This example sets the current level to 0.5 A, and then reads back the actual current value.

1 "INPUT OFF"	Turns off the load's input
2 "MODE CCL"	Selects the CCL mode
3 "CURR 0.5"	Sets current level to 0.5 A
4 "INPUT ON"	Turns on the load's input
5 "MEAS:CURR?"	Measures the actual input current

5.8 CV Mode Examples

This example presets the trigger voltage to 5 V, and selects the external trigger source.

1 "INPUT OFF"	Turns off the load's input
2 "MODE VOLT"	Selects the CV mode
3 "VOLT:TRIG 5"	Presets the trigger voltage to 5V
4 "TRIG:SOUR EXT"	Selects the external input as the trigger source
5 "INPUT ON"	Turns on the load's input

In this example, the input voltage will be set to 5 V when the change in the level of the external trigger signal is received.

5.9 CR Mode Examples

This example sets the current protection limit to 3 A, sets the time delay to 10 s, programs the resistance level to 10 Ω , and reads back the computed power.

1 "INPUT OFF"	Turns off the load's input
2 "MODE CRM"	Selects the CRM mode
3 "CURR:PROT:LEV 3.DEL 10"	Sets the current protection limit to 3 A and current protection delay time to 10 s
4 "CURR:PROT:STAT ON"	Activates the current protection
5 "RES 10"	Sets resistance level to 10 Ω
6 "INPUT ON"	Turns on the load's input
7 "MEAS:POW?"	Measures the input power level

5.10 Continuous Transient Operation Example

This example sets CV transient high/low levels, the associated times for transient rising/falling edge, high/low level times, and parameters for transient operation.

1 "INPUT OFF"	Turns off the load's input
2 "MODE CV"	Selects the CV mode
3 "VOLT:LLEV 0.5"	Sets the transient low level to 0.5 V
4 "VOLT:HLEV 1"	Sets the transient high level to 1 V
5 "TRAN:LTIM 200us"	Sets transient low level time to 200 μ s
6 "TRAN:HTIM 300us"	Sets transient high level time to 300 μ s
7 "TRAN:RTIM 10us"	Sets the time for transient rising edge to 10 μ s
8 "TRAN:FTIM 20us"	Sets the time for transient falling edge to 20 μ s
9 "TRAN:MODE CONT "	Selects the continuous transient operation
10 "TRAN ON"	Activates the transient operation
11 "INPUT ON"	Turns on the load's input

5.11 Pulsed Transient Operation Example

This example selects CV pulsed transient operation, selects the bus as the trigger source, and programs a pulse width of 1 millisecond.

1 "INPUT OFF"	Turns off the load's input
2 "MODE CV"	Selects the CV mode
3 "TRIG:SOUR BUS"	Selects the bus as the trigger source
4 "VOLT:LLEV 0.5"	Sets the transient low level to 0.5 V
5 "VOLT:HLEV 1"	Sets the transient high level to 1 V
6"TRAN:HTIM 1ms"	Sets transient high level time to 1 ms
7 "TRAN:RTIM 10us"	Sets the time for transient rising edge to 10 μ s
8 "TRAN:FTIM 10us"	Sets the time for transient falling edge to 10 μ s
9 "TRAN:MODE PULSE "	Selects the pulsed transient operation
10 "TRAN ON"	Activates the transient operation
11 "INPUT ON"	Turns on the load's input
12 "*TRG"	*TRG command generates a 1 millisecond high-level pulse at the load's input

6 Specifications

Type	SPL 250-30	SPL 400-40	SPL 200-20	SPL 350-30
Article number	K852A	K853A	K854A	K855A
Input Ratings				
Front Load Input	1	1	1	1
Current	0 ... 30 A	0 ... 40 A	0 ... 20 A	0 ... 30 A
Voltage	0 ... 80 V	0 ... 80 V	0 ... 200 V	0 ... 200 V
Power ¹	250 W at 40 °C	400 W at 40 °C	200 W at 40 °C	350 W at 40 °C
Input Characteristics				
Minimum Operating Voltage @ Full Scale Current	0.6 V	0.6 V	1.2 V	1.2 V
Constant Current Mode (CC)				
Low Range (CCL)	0 ... 3 A	0 ... 4 A	0 ... 2 A	0 ... 3 A
Resolution	0.1 mA	0.1 mA	0.1 mA	0.1 mA
Accuracy	0.1% + 5 mA	0.1% + 5 mA	0.1% + 5 mA	0.1% + 5 mA
High Range (CCH)	0 ... 30 A	0 ... 40 A	0 ... 20 A	0 ... 30 A
Resolution	1 mA	1 mA	1 mA	1 mA
Accuracy	0.1% + 10 mA	0.1% + 10 mA	0.1% + 10 mA	0.1% + 10 mA
Constant Voltage Mode (CV)				
Range	0 ... 80 V	0 ... 80 V	0 ... 200 V	0 ... 200 V
Resolution	1 mV	1 mV	2 mV	2 mV
Accuracy	0.1% + 10 mV	0.1% + 10 mV	0.1% + 25 mV	0.1% + 25 mV
Constant Resistance Mode (CR)				
Low Range (CRL)	0.02 to 2 Ω	0.02 to 2 Ω	0.0666 ... 6.66 Ω	0.0666 ... 6.66 Ω
Resolution	0.1 mΩ	0.1 mΩ	0.1 mΩ	0.1 mΩ
Accuracy	0.5% + 12 mΩ @ I > 4 A	0.5% + 12 mΩ @ I > 4 A	0.5% + 40 mΩ @ I > 3 A	0.5% + 40 mΩ @ I > 3 A
Middle Range (CRM)	2 ... 200 Ω	2 ... 200 Ω	6.66 ... 666 Ω	6.6 ... 666 Ω
Resolution	8.6 μS ²	8.6 μs	2.6 μS ²	2.6 μS
Accuracy	0.3% + 1.25 mS @ U > 8 V	0.3% + 1.25 mS @ U > 8 V	0.3% + 375 mS @ U > 20 V	0.3% + 375 mS @ U > 20 V
High Range (CRH)	20 ... 2000 Ω	20 ... 2000 Ω	66.6 ... 6660 Ω	66.6 ... 6660 Ω
Resolution	0.96 μs	0.96 μs	0.29 μS	0.29 μS
Accuracy	0.3% + 0.625 mS @ U > 8 V	0.3% + 0.625 mS @ U > 8 V	0.3% + 188 μS @ U > 20 V	0.3% + 188 μS @ U > 20 V
Constant Power Mode (CP)				
Range	0 ... 250 W	0 ... 400 W	0 ... 200 W	0 ... 350 W
Resolution @ P < 100 W	1 mW	1 mW	1 mW	1 mW
Resolution @ P ≥ 100 W	10 mW	10 mW	10 mW	10 mW
Accuracy	0.2% + 600 mW	0.2% + 600 mW	0.2% + 600 mW	0.2% + 600 mW
Current Measurement				
Low Range	0 ... 3 A	0 ... 4 A	0 ... 2 A	0 ... 3 A
Resolution	0.1 mA	0.1 mA	0.1 mA	0.1 mA
Accuracy	0.05% + 4 mA	0.05% + 4 mA	0.05% + 4 mA	0.05% + 4 mA
High Range	0 ... 30 A	0 ... 40 A	0 ... 20 A	0 ... 30 A
Resolution	1 mA	1 mA	1 mA	1 mA
Accuracy	0.05% + 8 mA	0.05% + 8 mA	0.05% + 8 mA	0.05% + 8 mA
Voltage Measurement				
Range	0 ... 80 V	0 ... 80 V	0 ... 200 V	0 ... 200 V
Resolution	1 mV	1 mV	1 mV	1 mV
Accuracy	0.1% + 8 mV	0.1% + 8 mV	0.1% + 50 mV	0.1% + 50 mV

Type	SPL 250-30	SPL 400-40	SPL 200-20	SPL 350-30
Article number	K852A	K853A	K854A	K855A
Power Measurement				
Range	0 ... 250 W	0 ... 400 W	0 ... 200 W	0 ... 350 W
Resolution @ P < 100 W	1 mW	1 mW	1 mW	1 mW
Resolution @ P ≥ 100 W	10 mW	10 mW	10 mW	10 mW
Accuracy	0.1% + 600 mW	0.1% + 600 mW	0.1 % + 600 mW	0.1 % + 600 mW
Current Slew Rates				
Range CCH	1 mA/μs ... 3 A/μs	1 mA/μs ... 4 A/μs	1 mA/μs ... 2 A/μs	1 mA/μs ... 3 A/μs
Range CCL ³	100 μA/μs ... 300 mA/μs	100 μA/μs ... 400 mA/μs	100 μA/μs ... 200 mA/μs	100 μA/μs ... 300 mA/μs
Resolution	1 mA/μs	1 mA/μs	1 mA/μs	1 mA/μs
Accuracy ⁴	3% + 10 μs	3% + 10 μs	3 % + 10 μs	3 % + 10 μs
Transient Operation				
Transient Mode	Continuous, pulse, toggled	Continuous, pulse, toggled	Continuous, pulse, toggled	Continuous, pulse, toggled
Frequency Range ⁵	0.38 Hz ... 50 kHz	0.38 Hz ... 50 kHz	0.38 Hz ... 50 kHz	0.38 Hz ... 50 kHz
Highest/Lowest Time	0 ... 655.35 ms	0 ... 655.35 ms	0 ... 655.35 ms	0 ... 655.35 ms
Resolution	10 μs	10 μs	10 μs	10 μs
Accuracy	0.2% + 10 μs	0.2% + 10 μs	0.2 % + 10 μs	0.2 % + 10 μs
Rise/Fall Time	10 μs ... 655.35 ms	10 μs ... 655.35 ms	10 μs ... 655.35 ms	10 μs ... 655.35 ms
Resolution	10 μs	10 μs	10 μs	10 μs
Accuracy	0.2% + 10 μs	0.2% + 10 μs	0.2 % + 10 μs	0.2 % + 10 μs
List Characteristics (Sequence)				
Step Rate	10 μs ... 100,000 s	10 μs ... 100,000 s	10 μs ... 100000 s	10 μs ... 100000 s
Resolution	10 μs	10 μs	10 μs	10 μs
Accuracy	0.2% + 10 μs	0.2% + 10 μs	0.2 % + 10 μs	0.2 % + 10 μs
Number of Steps	1 ... 50	1 ... 50	1 ... 50	1 ... 50
Cycle	1 ... 65,535	1 ... 65,535	1 ... 65535	1 ... 65535
Storage Capacity	7 Lists	7 Lists	7 Lists	7 Lists
Expanded Functions	Chain	Chain	Chain	Chain
Battery Discharge				
Discharge Time	1 s ... 100 h	1 s ... 100 h	1 s ... 100 h	1 s ... 100 h
Resolution	1 s	1 s	1 s	1 s
Accuracy	0.2% + 1 s	0.2% + 1 s	0.2 % + 1 s	0.2 % + 1 s
Battery Capacity	1 mA ... 3000 Ah	1 mA ... 4000 Ah	1 mA ... 2000 Ah	1 mA ... 3000 Ah
Resolution	1 mAh	1 mAh	1 mAh	1 mAh
Accuracy	0.3% + 0.01 Ah	0.3% + 0.01 Ah	0.3 % + 0.01 Ah	0.3 % + 0.01 Ah
Short Circuit				
CCL Mode	3.3 A	4.4 A	2.2 A	3.3 A
CCH Mode	33 A	44 A	22 A	33 A
CV Mode	0 V	0 V	0 V	0 V
CRL Mode	0.0180 Ω	0.0180 Ω	0.06 Ω	0.06 Ω
CRM Mode	1.80 Ω	1.80 Ω	6 Ω	6 Ω
CRH Mode	18 Ω	18 Ω	60 Ω	60 Ω
CPV Mode	270 W	420 W	220 W	370 W
CPC Mode	0 W	0 W	0 W	0 W
Maximum Slew Rate				
Current	3 A/μs	4 A/μs	2 A/μs	3 A/μs
Voltage	0.6 V/μs	0.6 V/μs	0.6 V/μs	0.6 V/μs
Programmable Open Circuit	≥ 20 kΩ	≥ 20 kΩ	≥ 20 kΩ	≥ 20 kΩ
Trigger Input				
Trigger Level	TTL falling edge	TTL falling edge	TTL falling edge	TTL falling edge
Trigger Pulse Width	≥ 10 μs	≥ 10 μs	≥ 10 μs	≥ 10 μs
Maximum Input Levels				
Current	33 A	44 A	22 A	33 A
Voltage	84 V	84 V	210 V	210 V
Protection Features	OV, OC, OP, OT, RV	OV, OC, OP, OT, RV	OV, OC, OP, OT, RV	OV, OC, OP, OT, RV

Type	SPL 250-30	SPL 400-40	SPL 200-20	SPL 350-30
Article number	K852A	K853A	K854A	K855A
Reverse Current Capacity				
Input OFF	25 A	30 A	25 A	25 A
Input ON	40 A	50 A	35 A	40 A
Ripple and Noise				
Current (rms/p-p)	3 mA / 30 mA	3 mA / 30 mA	3 mA / 30 mA	3 mA / 30 mA
Voltage (rms)	5 mV	5 mV	12 mV	12 mV
Environmental Conditions				
Temperature	0 ... 50 °C	0 ... 50 °C	0 ... 50 °C	0 ... 50 °C
Relative Humidity	≤ 85%	≤ 85%	≤ 85%	≤ 85%
Remote Interface ⁶	RS232, GPIB	RS232, GPIB	RS232, GPIB	RS232, GPIB
Programming Language	SCPI	SCPI	SCPI	SCPI
Mains Input				
Supply Voltage	AC 115 V / AC 230 V +10/-15%	AC 115 V / AC 230 V +10/-15%	AC 115 V / AC 230 V +10/-15%	AC 115 V / AC 230 V +10/-15%
Line Frequency	48 ... 63 Hz	48 ... 63 Hz	48 ... 63 Hz	48 ... 63 Hz
Dimensions	213 mm x 104 mm x 391 mm	213 mm x 104 mm x 391 mm	213 mm x 104 mm x 391 mm	213 mm x 104 mm x 391 mm
Dimensions with rubber protection	226 mm x 110 mm x 414 mm	226 mm x 110 mm x 414 mm	226 mm x 110 mm x 414 mm	226 mm x 110 mm x 414 mm
Net Weight	5.8 kg	5.8 kg	5.8 kg	5.8 kg
Gross Weight (rubber protection included)	Approx. 6 kg	Approx. 6 kg	Approx. 6 kg	Approx. 6 kg

¹⁾ Maximum continuous power available is derated linearly from 100% of maximum at 40 °C to 75 % of maximum at 55 °C.

²⁾ Conductance (S) = 1 / resistance (Ω).

³⁾ The setpoint is 10 times larger than the rise rate in CCL mode (constant current low level range).

⁴⁾ The momentary transition time is defined as the time required for the input to change from 10% to 90% or from 90% to 10% of the programmed excursion.

⁵⁾ Transient frequency depends on the time for high/low level and rising/falling edge.

⁶⁾ Full remote control via RS232 with optional GPIB.

Dimensions

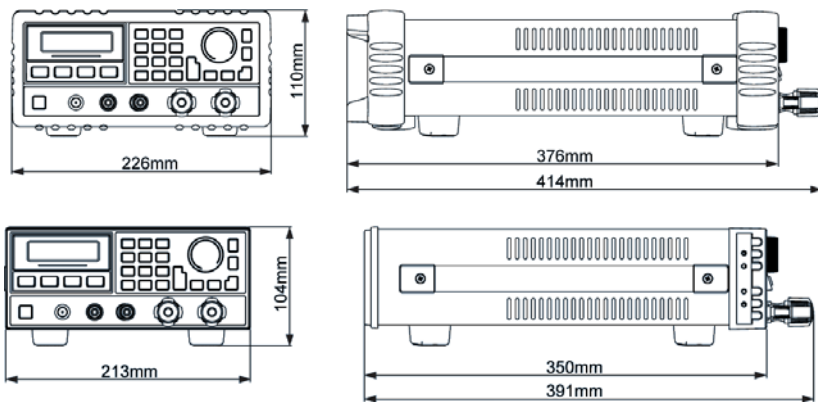

7 Repair and Replacement Parts Service

When you need service, please contact:

GMC-I Service GmbH
Service-Center
Thomas-Mann-Straße 16 - 20
90471 Nürnberg • Germany
Phone +49 911 817718-0
Fax +49 911 817718-253
E-Mail service@gossenmetrawatt.com
www.gmci-service.com

8 Product Support

When you need service, please contact:

GMC-I Messtechnik GmbH
Hotline Produktsupport
Phone +49 911 8602-0
Fax +49 911 8602-709
E-Mail support@gossenmetrawatt.com

Edited in Germany • Subject to change without notice • A pdf version is available on the internet

 **GOSSEN METRAWATT**

GMC-I Messtechnik GmbH
Südwestpark 15
90449 Nürnberg • Germany

Phone +49 911 8602-111
Fax +49 911 8602-777
E-Mail info@gossenmetrawatt.com
www.gossenmetrawatt.com