

Operating Instructions

METRA HIT | 27EX

Milliohmmeter for deployment
in potentially explosive atmospheres

3-349-336-49
7/2.15



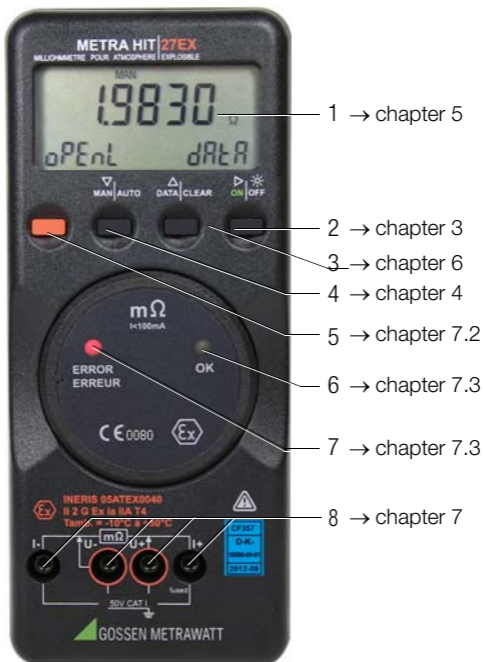

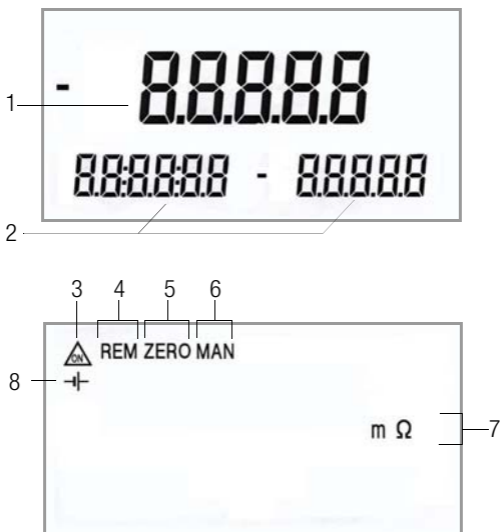

Measurement only on voltage-free objects!

- 1 Display (LCD)
- 2 ON/OFF key for ON / OFF
(ON short: instrument ON → ON short: background illumination ON →
→ OFF short: background illumination OFF → OFF long: instrument OFF)
Operating mode menu: open submenus / acknowledge entries
- 3 DATA/CLEAR key for the functions save/delete measured value
Operating mode menu: Selection of individual menu items
against direction of flow,
△ increase values
- 4 MAN/AUTO key for manual measuring range selection
Operating mode menu: Selection of individual menu items
in direction of flow
▽ decrease values
- 5 **MENU/ESC**
Operating mode menu: Exit menu level and
return to a higher level,
exit parameters configuration
without saving data
- 6 LED **OK** blinks: valid measured value
- 7 LED **ERROR** blinks: incorrect connection
- 8 Connector jacks *



Symbols used in the Digital Display

- 1 Main display with decimal point
- 2 Auxiliary displays
- 3 : Milliohm meter in continuous operation, ON blinks at transmission frequency in transmission mode
- 4 REM: Memory mode operation, disappears after communication via the interface is ended by means of key or switch operation
- 5 ZERO: Zero balancing
- 6 MAN: Manual measuring range selection
- 7 Unit of measure (if blinking, refer to chapter 11 on page 33)
- 8 : Low battery voltage, replace batteries

- * I- Measurement input
- U- Sense - for 4-wire measurement
- U+ Sense + for 4-wire measurement
- I+ mΩ; Ω measurement input

Contents	Page
1 Application	5
2 Safety Features and Precautions	5
3 Initial Start-Up	8
4 Selecting Measuring Functions and Measuring Ranges .10	
4.1 Automatic Measuring Range Selection	10
4.2 Manual Measuring Range Selection	10
4.3 Quick Measurements	10
5 Triple Digital Display	11
6 Measured Value Storage	12
6.1 Measured Value Storage – Key Function “DATA”	12
7 Milliohm Measurement (4-Pole-Measurement) ... 14	
7.1 Compensation of Cable Resistance	14
7.1.1 Measurement with Kelvin Probe KC27	14
7.2 Thermovoltage Compensation	15
7.3 Milliohm Measurement with ≤ 100 mA DC [$m\Omega$]	16
8 Using the Menus – from the Initial InFO Menu to Operating and Measuring Parameters	17
8.1 Sampling <i>rAtE</i>	17
8.2 Saving Measured Values	18
8.2.1 Memory Mode – DATA Key Function (see also chapter 6.1) ..	18
8.2.2 Memory Mode Operation – STORE Menu Function	19
8.3 Querying Memory Occupancy – INFO ▷ MEMO/OCCUP	19
8.4 Clearing the Memory – MEMO ▷ CLEAR	20
8.5 Activating the Default Values	20
8.6 Transmission Mode Operation with RS 232 or USB Interface	21
9 Characteristic Values	26
10 Maintenance	30
10.1 Batteries	30
10.2 Fuses	31
10.3 Housing and Display	32
10.4 Collection of Used Instruments and Environmentally Compatible Disposal	33
11 System Messages	33
12 Repair and Replacement Parts Service, Calibration Center and Rental Instrument Service	34
13 Manufacturer’s Guarantee	35
14 Product Support	35
15 Recalibration	36

1 Application

METRA HIT | **27EX** is a milliohmmeter with 4-pole measurement, which is designed for deployment in potentially explosive environment.

In accordance with directive 94/9/CE dated 23th March 1994 the device is approved for being used in explosive, gaseous atmospheres (IIA T4) with ambient temperatures between $-10\text{ }^{\circ}\text{C}$ and $+50\text{ }^{\circ}\text{C}$.

The device conforms to the following standards:

- EN 60079-0:2009 and EN 60079-0:2012
- EN 60079-11:2012

It bears CE certification number, type INERIS 05ATEX0040, which has been conferred by the Ineris certification authority.

2 Safety Features and Precautions

You have selected an instrument which provides you with high levels of safety.

This instrument fulfills the requirements of the applicable European and national EC guidelines. We confirm this with the CE marking. The relevant declaration of conformity can be obtained from GMC-I Messtechnik GMBH.

The METRA HIT | **27EX** is manufactured and tested in accordance with safety regulations IEC 61010–1:2010 / EN 61010–1:2010/VDE 0411–1:2011/EN 60079-0:2009 and EN 60079-0:2012/EN 60079-11:2012. When used for its intended purpose, safety of the operator, as well as that of the instrument, is assured. Their safety is however not guaranteed, if the instrument is used improperly or handled carelessly.

In order to maintain flawless technical safety conditions, and to assure safe use, it is imperative that you read the operating instructions thoroughly and carefully before placing your instrument into service, and that you follow all instructions contained therein.

Use for Intended Purpose:

- The milliohmmeter described herein is a portable instrument which can be held in one hand during measurements.
- The milliohmmeter may only be operated with the included or with type-tested batteries, as specified in the Characteristic Values.
- The milliohmmeter may only be operated with closed housing. The instrument must be removed from the potentially explosive environment before opening the housing to replace batteries or fuses.
- Only the type-tested fuses specified in the Characteristic Values may be used.
- The milliohmmeter may only be used to perform such measurements as described in chapter 7.
- The limits of the overload capacity may not be exceeded. Refer to the “Characteristic Values” on page 26 for overload values and overload duration.

- Measurements may only be performed within the indicated ambient conditions. See page 29 for operating temperature range and relative humidity.
- The instrument may not be used in a dusty atmosphere.
- No maintenance operation may be performed in potentially explosive atmospheres (cleaning, replacement of batteries, opening the device, etc.)

Observe the following safety precautions:

- **Type-tested Housing**

The milliohmmeter may not be operated with open housing.

In a potentially explosive atmosphere the housing may not be opened. In this case, there is no protection against explosions.

- **Type-tested Batteries**

Use the included or other type-tested batteries with identical technical features only, see Characteristic Values.

Before use, please make sure that the housing cover is closed. There is no protection against explosions when the housing is open.

Batteries may only be replaced outside the potentially explosive environment. No spare batteries may be brought into the potentially explosive environment.

- **Operation by qualified electricians**

The instrument may only be operated by persons who are capable of recognizing shock hazards and taking the appropriate safety precautions. Shock hazards exist anywhere, where voltages of greater than 33 V (RMS) may occur.

- **Shock Hazards**

Avoid working alone when taking measurements which involve shock hazards. Be certain that a second person is present.

- **Measurement Cables**

Make sure that all measurement cables are in faultless condition, e.g. undamaged insulation, no interruptions in cables and plugs, etc.

- **Unexpected Voltages**

Be prepared for the occurrence of unexpected voltages at devices under test (e.g. defective devices, after inspecting the winding resistance of contactor relays, etc.). For example, capacitors can still be dangerously charged.

Perform measurements on voltage-free objects only.

- **Type-tested Fuses** (cannot be replaced by the user)

Only use type-tested fuses, as specified in the Characteristic Values. There is no protection against explosions when other fuses are used.

In order to prevent major damage to the instrument when interference voltage is applied (within the admissible limit values), the $m\Omega/\Omega$ measuring circuit is equipped with a fuse F1 which makes these measur-

ing circuits highly resistive for the duration of the overload when high currents occur as a result of a disturbance. Another fuse F2 is located in the path between batteries and instrument.

- **Dusty Atmosphere**

The instrument may not be used in a dusty atmosphere.

Meanings of symbols on the instrument:



Warning concerning a source of danger (attention: observe documentation!)



Ground



Continuous, doubled or reinforced insulation



Indicates EC conformity



Symbol for explosion protection: Electrical equipment for intended use in potentially explosive environments per EN 60079-11



This device may not be disposed of with the trash. Further information regarding the WEEE mark can be accessed on the Internet at www.gossenmetrawatt.com by entering the search term 'WEEE'.

Repair, Parts Replacement and Balancing

When the instrument is opened, voltage conducting parts may be exposed. The instrument must be disconnected from the measuring circuit before the performance of repairs, the replacement of parts, or balancing. If balancing, maintenance or repair of a live open instrument is required, this may only be carried out by trained personnel who are familiar with the dangers involved.

Defects and Extraordinary Strains

If it may be assumed that the instrument can no longer be operated safely, it must be removed from service and secured against unintentional use. This applies particularly for potentially explosive environments.

Safe operation can no longer be relied upon,

- If the instrument or the test probes are damaged
- If the instrument no longer functions
- If the limits of the overload capacity have been exceeded, e.g. after the fuse has blown
- After long periods of storage under unfavorable conditions (e.g. humidity, dust, or excessive temperature), see „Ambient Conditions“ on page 29.

3 Initial Start-Up

Insert Batteries



Warning!

Remove the instrument from the potentially explosive environment before opening.
Only use the included type-tested batteries, as indicated in the Characteristic Values.

Refer to chapter 10.1 regarding correct battery installation.



Note!

As a result of internal voltage monitoring, the instrument may respond as follows if the battery voltage level is low:

- Cannot be switched on
- Shuts back down immediately
- Shuts back down immediately when a load is applied in the $m\Omega$ range.

If this is the case, replace the batteries.



Warning!

Never replace the batteries in potentially explosive atmospheres.

Switching the Instrument On Manually

- Press the ON/OFF key.
As long as the key is held depressed, all of the segments at the LCD are illuminated. The LCD is shown on page 2. Power-up is acknowledged with a brief acoustic signal. The instrument is ready for use as soon as the key is released.

Switching the Instrument On with a PC

After transmission of a data frame from the PC, the milliohmmeter is switched on. See also chapter 8.6.

Switching the Instrument On Automatically

The milliohmmeter is switched on automatically in the transmission and memory modes.



Note!

Electrical discharge and high frequency interference may cause incorrect displays to appear, and may disable the measuring sequence. In such cases, switch the instrument off and back on again in order to reset. If the problem persists, briefly dislodge the batteries from the connector contacts.

Setting Time and Date

See chapter 8 on page 17.

Switching the Instrument Off Manually

- Press the ON/OFF key until OFF is shown on the display.

Shutdown is acknowledged with two, brief acoustic signals.

Switching the Milliohmmeter Off Automatically – „SLEEP MODE“

The instrument is switched off automatically if none of the keys are activated for approximately 10 minutes. Shutdown is acknowledged with a brief acoustic signal.

Transmission mode: In this case, checking is first performed to determine whether or not the sampling rate has been set to a value of greater than 10 s. The instrument is switched off after 10 minutes, but the instrument is reactivated 10 s before data is to be saved to memory. The instrument is then switched back off again.

In the transmission mode, the instrument can be manually activated with the ON/OFF key. After activation of this type, the instrument returns to the “SLEEP MODE”.

If the instrument is to be fully shut down, it must first be activated and then switched off with the ON/OFF key. This ends both memory mode and transmission mode operation.

We recommend setting the instrument to continuous operation for **transmission mode** operation.

The continuous operation mode is not effected by automatic shutdown.

Disabling Automatic Shutdown

The instrument can be set to continuous operation.

- Press and hold the MENU/ESC key and then switch the instrument on by pressing the ON/OFF key. Continuous operation is indicated at the display with the  symbol.

Switching LCD Illumination On and Off

- Briefly press the ON/OFF key after the instrument has already been switched on.

Illumination is switched off automatically after approximately 2 minutes.

Note: Electrical discharge and high frequency interference may cause incorrect displays to appear, and may disable the measuring sequence. In such cases, switch the instrument off and back on again in order to reset.

If the problem persists,

- 1 leave the potentially explosive environment,**
- 2 disconnect the instrument from the measuring circuit before opening and refer to chapter 10.1 „Batteries“,
- 3 Briefly dislodge the batteries from the connector contacts.

4 Selecting Measuring Functions and Measuring Ranges

4.1 Automatic Measuring Range Selection

The milliohmmeter is equipped with auto-ranging for all measuring ranges. Auto-ranging is active as soon as the instrument is switched on. The instrument automatically selects the measuring range which allows for highest possible resolution for the applied quantity.

The instrument automatically switches to the next highest or next lowest measuring range for the following measured quantities:

Measuring Ranges	Resolution	Switching to next highest range at $+ (... d + 1 d)$	Switching to next lowest range at $+ (... d - 1 d)$
300 m Ω , 3 Ω , 30 Ω	4 $\frac{3}{4}$	31 000	2 800
30 m Ω	3 $\frac{3}{4}$	3 100	280

4.2 Manual Measuring Range Selection

Auto-ranging can be deactivated and measuring ranges can be selected manually in accordance with the following table.

The manual mode is deactivated by pressing and holding the MAN/AUTO key (approx. 1 s) or by switching the instrument off and then back on again.

\Downarrow MAN/AUTO	Function	Acknowledgement	
		Display	Acoust. Signal
short	Manual mode active: utilized measuring range is fixed	MAN	1 x
short	Range switching sequence for: m Ω : 30 m Ω \rightarrow 300 m Ω \rightarrow 3 Ω \rightarrow 30 Ω \rightarrow 30 m Ω \rightarrow ...	MAN	1 x
long	Return to automatic range selection	—	2 x



Note!

If the red ERROR LED lights up and OL is shown on the display during manual measuring range selection, you should switch to the next higher range.

4.3 Quick Measurements

If you wish to perform quicker measurements than those possible with the automatic measuring range selection function, make sure to establish the appropriate measuring range and to perform the following two functions:

- by **manual measuring range selection**, i. e. by selecting the measuring range with the best resolution, see chapter 4.2.

or

- via **DATA function**, see chapter 6.1. After the first measurement, the proper measuring range will be automatically determined so that measurements are performed more rapidly from the second measured value onwards.

With both functions, the established measuring range is maintained for the subsequent series mode measurements.

5 Triple Digital Display

The three digital displays (1 main display and 2 auxiliary displays) show the measured value with decimal and plus or minus sign. The selected unit of measure is displayed as well.

“OL” (overload) appears if the measuring range upper limit is exceeded for the following measured quantities (the red ERROR LED lights up simultaneously and **OPENL** appears on the auxiliary display):

300 mΩ, 3 Ω, 30 Ω:	30999
30 mΩ:	3099

The digital display is refreshed at different frequencies for the various measured quantities.

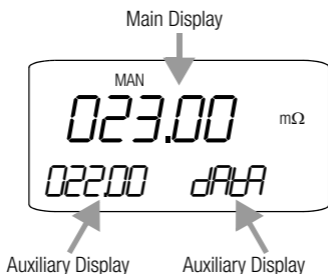

The main display appears immediately after the milliohm-meter is switched on, but the auxiliary displays have to be activated by pressing the DATA/CLEAR key.

In the following flowcharts, the initial displays are highlighted through the use of a bold border line.

6 Measured Value Storage

The METRA HIT | 27EX provides two entirely different options for storing data:

- **Measured Value Memory – DATA Key Function:**
Each time the DATA key is pressed and a measuring point is contacted, a measured value is stored (see chapter 6.1).
- **Memory Mode Operation – STORE Menu Function:**
After activating the STORE menu function, all measured values are saved in accordance with the selected sampling rate. Memory mode operation is ended manually using the same menu function, see chapter 8.2.

In both cases, saved measured values can be read out with the help of METRAWin®10 PC software (as of version 5.22). However, read-out is only possible if a IR adapter (BD232 or USB-HIT) has been plugged into the METRA HIT | 27EX and connected to the PC with an interface cable (see Data Interface page 29).

6.1 Measured Value Storage – Key Function “DATA”

Measured values can be automatically “frozen” with the DATA hold function. This is useful when, for example, contacting the measuring points with the test probes requires your full attention.

Preparation of Measurement

Memory should be cleared before starting a measurement series with the DATA key function.

This assures, on the one hand, that adequate memory capacity is available and, on the other hand, that only data from the last measurement series are read out in a contiguous fashion. Check current memory occupancy to this end: INFO ▷ MEMO/OCCUP

Clear memory if required: MEMO ▷ CLEAR.

Performing Measurements

⇒ Press the DATA key.

The message *dAtA* blinks and indicates readiness for acquiring the first measured value.

⇒ Contact the measuring point as described in chapter 7.3.

After applying the test probes to the measuring point:

- the green LED OK indicates: safe measurement connection.
- The initially acquired value is transferred to the main display where it remains stored. This is acknowledged by two successive acoustic signals.
„MAN“ (and, additionally, „ZERO“ in the MΩ measuring ranges) is displayed simultaneously and indicates that the measuring range is now fixed.
- the momentary measured values continue to be shown in the auxiliary display on the left.

⇒ Lift the test probes from the measuring point.

The message *aPErL* appears on the auxiliary display.

The red LED ERROR lights up as long as no contact has been established between the test probes and the measuring point. The green LED OK continues to light up when a valid measured value has already been stored.

Prior to contacting the next measuring point, the function DATA must be activated once more by pressing the DATA key. The message *dAtA* blinks and indicates readiness for acquiring the next measured value.

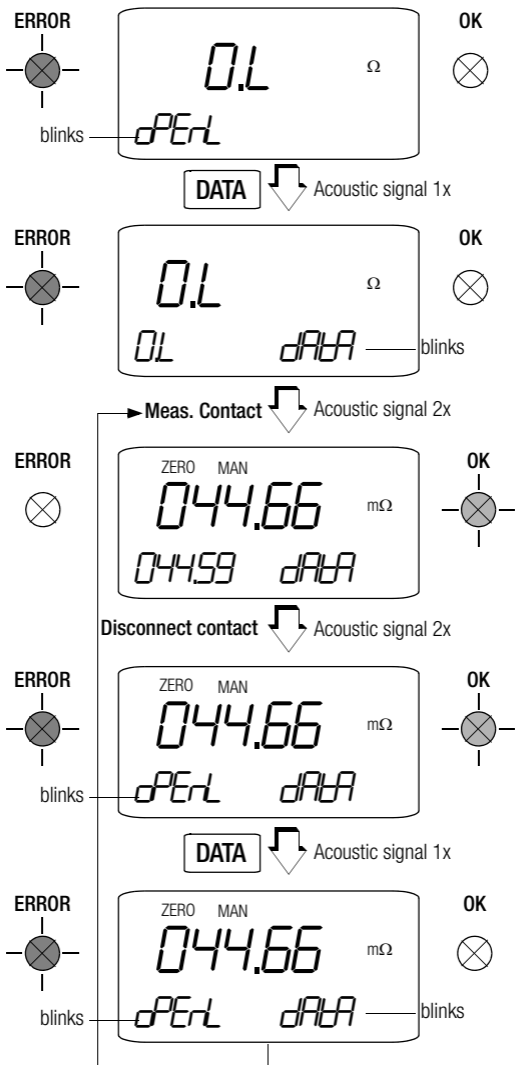

As long as the DATA function is active and all measurements are within the measuring range which has been

automatically adjusted, the measuring ranges should not be changed manually.

The DATA function is deactivated if the DATA/CLEAR key is pressed and held (approx. 1 s) or by switching the instrument off and back on again.

7 Milliohm Measurement (4-Pole-Measurement)

7.1 Compensation of Cable Resistance

Electrical resistance is a dipole quantity which can generally only be measured using two poles. This is accomplished by directing a measuring current of predetermined magnitude through the device under test, and measuring the resultant voltage drop. The respective resistance value is derived from the quotient of these two values.

The two points between which voltage is measured are decisive as regards the results of the measurement. All resistances between these two points add to the measured resistance value. These include contact resistance, as well as cable resistance. If a very low resistance value needs to be measured, for example contact resistance at a contactor with a value of only a few milliohms, the points between which voltage is measured must be moved out of the measuring instrument and positioned as closely as possible to the device under test. For this reason, the measuring instrument is equipped with separate jacks for current feed and voltage measurement. This type of 4-pole connection is known as connection according to Kelvin.

KC4 Kelvin clips and KC27 Kelvin probes (available as accessories) allow for easy, correct connection.

7.1.1 Measurement with Kelvin Probe KC27

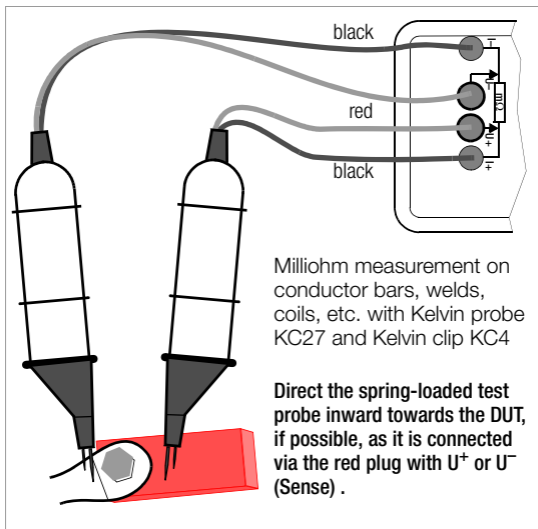

7.2 Thermovoltage Compensation

Thermovoltages which occur as a result of material and temperature differences may distort measurement results. For this reason, the instrument is equipped with automatic thermovoltage compensation in the relevant measuring ranges.

After switching on the milliohmmeter, „tErToc“ is displayed, indicating that an automatic thermovoltage compensation for the 30 m Ω and 300 m Ω measuring ranges will be performed in the background for all future measurements. ZERO signals that the value of the thermovoltage has already been taken into account for the indicated measuring result.

After the first measurement – lift the test probe from the measuring point – „tErToc“ disappears to facilitate the reading of the measured values. The automatic thermovoltage compensation remains activated.

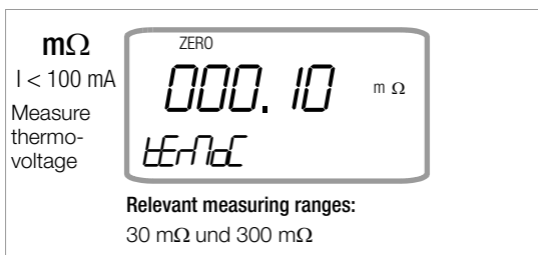

7.3 Milliohm Measurement with $\leq 100 \text{ mA DC}$ [$\text{m}\Omega$]

- Make sure that the device under test is voltage-free.
- Connect the device under test as shown.

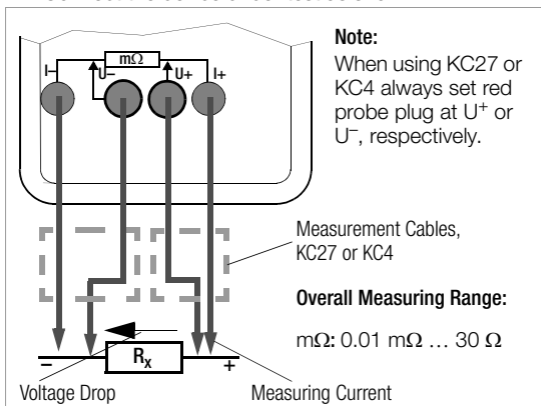

KC4 Kelvin clips and KC27 Kelvin probes (available as accessories) allow for easy, correct connection.

Resistance at the current jacks should amount to $< 1 \Omega$.

- If applicable, select the desired measuring range using the MANIAUTO key: **30 mΩ**, **300 mΩ**, **3 Ω** or **30 Ω**.
- Contact the measuring point.
The green LED OK must light up.



Note!

If the measuring current is interrupted during 4-wire-mΩ-measurement or if the fuse F1 is defective, the message „oPEr“ flashes on the display and the red LED ERROR lights up.

If fuse is defective, see chapter 10.2.

8 Using the Menus – from the Initial InFO Menu to Operating and Measuring Parameters

Menu-driven operation via the initial „InFO“ menu allows the user to query online help, activate the memory and query memory occupancy, activate the interface and configure device parameters.

- The initial „InFO“ menu is accessed by simultaneously pressing and holding the MENU/ESC and ON/OFF keys with the instrument switched on, until „InFO“ appears at the display.
- The display can be switched from the main „InFO“ menu to the other main menus including “StorE”, “rENd”, “SEnd” and “SEt”, and then back to the „InFO“ menu, by repeatedly pressing the ∇/Δ keys.
- After accessing the desired main menu, the associated submenus are opened by activating the \triangleright key.
- The desired parameter or the desired function is selected by repeatedly pressing the ∇/Δ keys.
- Acknowledge with the \triangleright key in order to change the corresponding parameter or parameters.
- After the desired digit has been selected with the $\triangleleft/\triangleright$ keys and the value has been adjusted with the ∇/Δ keys, the next digit is accessed with the \triangleright key, or the display is returned to the start menu or switched to the next submenu.
- The measuring mode is started by repeatedly pressing the MENU/ESC key until the measuring display appears.
- The milliohmmeter is switched off by pressing and holding the ON/OFF key until the display goes blank.

The following pages include an overview of the menu structure.

8.1 Sampling rAtE

The sampling rate specifies the time interval after which the respective measured value is transmitted to the interface or to measured value memory. See page 24 for possible settings. The lower limit of the sampling rate which cannot be fallen short of, is 0.5 s.

8.2 Saving Measured Values

The METRA HIT | 27EX provides two entirely different options for storing data:

- **Messwertspeicherung – Tastenfunktion DATA: Measured Value Memory – DATA Key Function:**
Each time a measuring point is contacted, a measured value is stored in accordance with a defined condition (see chapter 6.1 and chapter 8.2.1).
- **Memory Mode Operation – STORE Menu Function:**
After activating the STORE menu function, all measured values are saved in accordance with the selected sampling rate. Memory mode operation is ended manually using the same menu function.

In both cases, saved measured values can be read out with the help of METRAwin[®]10 PC software (as of version 5.22). However, read-out is only possible if a BD232 IR adapter has been plugged into the METRA HIT | 27EX and connected to the PC with an interface cable.

8.2.1 Memory Mode – DATA Key Function (see also chapter 6.1)

The instrument is equipped with a measured value memory (32 kB) which is synchronized with a quartz movement, and has an average capacity of 1000 measured values. Minimum capacity is 800 measured values and maximum capacity is 1200 measured values. Data are stored and can be transmitted directly to a PC with the METRAwin[®]10 software. Date and time must be reset if the batteries are depleted and/or replaced.

Measured values are stored in so-called blocks. Measured values resulting from the same measuring function are saved to the same block.

Only absolute values and absolute time stamps can be saved, i.e. no relative or Δ values, and no relative time stamps.

Memory content can only be read out with the help of a PC, an IR adapter (BD232), and METRAwin[®]10 analysis software.

Stored measurement data blocks are retained even if the instrument is without voltage supply.

Vorbereitungen für den Speicherbetrieb

Preparing for Memory Mode Operation

- First set the **sampling rate** for memory mode operation, and then start memory mode operation.
The sampling rate can also be changed during memory mode operation.
- First select the desired measuring function and an appropriate measuring range.
- Check the battery voltage level before starting long-term measurement recordings (see chapter 10.1 on page 30).

8.2.2 Memory Mode Operation – STORE Menu Function

- First set the **sampling rate** for memory mode operation, and then start memory mode operation. The sampling rate can also be changed during memory mode operation.
- First select the desired measuring function and an appropriate measuring range.
- Check the battery voltage level before starting long-term measurement recordings, see chapter 10.1 on page 30.

Starting Memory Mode Operation with Menu Functions

- Open the “Operating Mode” menu (refer to the menu diagram) and select the StorE function.
- Now activate the ▷ key to open the start menu for memory mode operation: StArt blinks. Activate the ▷ key once again in order to start memory mode operation: REM appears at the display.
- Press the ◀ key in order to switch to the measuring function.

The “SLEEP MODE” is still active, i.e. the device is switched on and off automatically at sampling rates of long duration (see chapter 3).

When memory capacity has been exhausted, MEMO FULL appears at the display, and an acoustic signal is generated simultaneously. The signal can be deactivated by pressing any key.

REM Display

The REM symbol indicates that memory mode operation has been activated via menu function STORE.

Press the ◀ key if you wish to monitor the measured values also during the memory process.

The „STORE“ function cannot be started while the „DATA“ function is activated.

Exiting Memory Mode Operation with Menu Functions

- Select the StorE menu.
- Activate the ▷ key: StOP blinks.
- Activate the ▷ key once again: the auxiliary displays are cleared. Memory mode operation has now been deactivated.
- Press the ◀ key in order to return to the measuring function.
- Memory mode operation can also be exited by switching the instrument off.

8.3 Querying Memory Occupancy – INFO ▷ MEMO/OCCUP

Memory occupancy can be queried from the „*Info*“ menu. The main display shows current occupancy as a percentage between 001 and 100%.



Attention!

This function deletes all measured values from memory.

This function cannot be performed during memory mode; $\text{bUSY}_{\text{MEMO}}$ is displayed instead of CLEAR.

8.5 Activating the Default Values

Previously entered changes can be undone, and the default settings can be reactivated. This may be advisable after the occurrence of software or hardware errors.

- Simultaneously press and hold the MENU/ESC, MANIAUTO and DATA/CLEAR keys, and switch the instrument on with the ON/OFFkey.

8.6 Transmission Mode Operation with RS 232 or USB Interface

The METRA HIT | 27EX is equipped with an bidirectional infrared interface for the transmission of measurement data to a PC. Data are transferred optically through the instrument housing by means of infrared light to an interface adapter (accessory BD232 or USB-HIT), which is attached to the instrument. The adapter's RS 232 or USB interface allows for the establishment of a connection to the PC via an interface cable. Beyond this, commands and parameters can be transmitted from the PC to the instrument as well. The following functions can be executed:

- Configuration and read-out of measuring parameters
- Measuring function and measuring range selection
- Start measurements
- Read out measured values.

Activating the Interface

The interface is switched on manually as described below for transmission mode operation. The instrument continuously transmits measurement data to the PC via the interface adapter in this operating mode. The interface is activated automatically by the PC for receiving operation (i.e. the instrument receives data from the PC).

Starting Transmission with Menu Functions

InFO ▾ SEnd ▷ StArt ▷

The  symbol blinks at the display in order to indicate interface operation.

Automatic Activation and Deactivation of the Transmission Mode

If the sampling rate is 20 s or longer, the display is switched off automatically between samples in order to prolong battery service life.

Exception: continuous operation

As soon as an event occurs, the display is automatically switched back on.

Configuring Interface Parameters

Addr – Address

If several milliohmmeters are connected to the PC via interface adapters, an unique address must be assigned to each device. Address 1 should be used for the first device, address 2 for the second etc. If only one milliohmmeter is utilized, an address between 1 and 14 should be used. Address 15 is not used for addressing, i.e. the device with address 15 always responds, regardless of the actual address.

Main Menus and Submenus

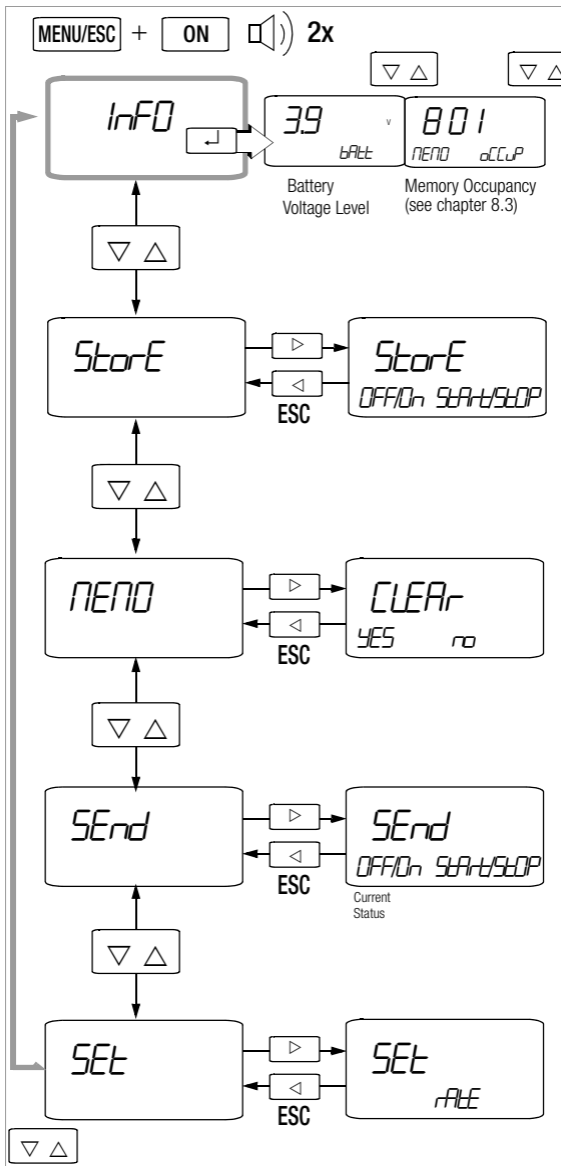

Query Information



tIME
12:58:08

dATE
150802

tCAL
150802

tADU
150802

Current Time

Current Date

Calibration Date

Balancing Date

Memory Mode Menu



StArt blinks

▷ Activate:

Memory mode active

REM is displayed



StOP blinks

▷ Activate:

Memory mode inactive

REM disappears

Delete Memory Menu (see chapter 8.4)



Selection must blink:

YES: delete memory

no: do not delete



Acknowledge
selection

During memory mode the memory cannot be deleted, BUSY_{MEMO} is displayed instead of CLEAR.

Display „EMPTY“: Memory is empty

Transmission Mode (see chapter 8.6)



StArt blinks

▷ Activate:

Transmission mode

active

▲ blinks



StOP blinks

▷ Activate:

no Transmission mode

▲ does not blink

Configure Device Parameters (see chapter 8.1)

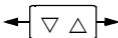

See next page for
more submenus

Continued from previous page

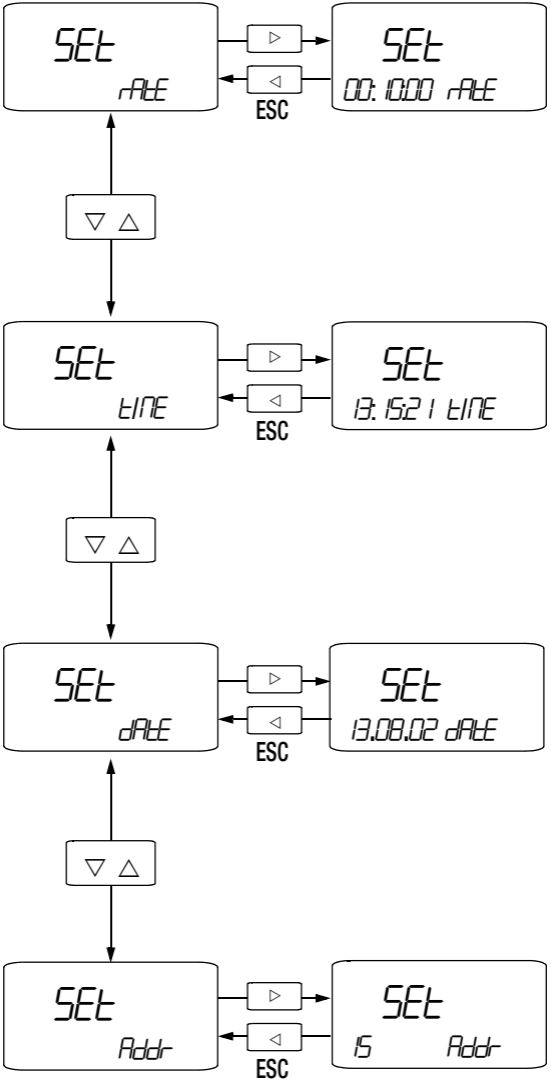

Set Sampling Rate (see also chapter 8.1)



Change
Value



Acknowledge
Sampling Rate

Possible Settings

(hh:mm:ss, h = hours, m = minutes, s = seconds)

00:00:01, 00:00:02, 00:00:05, 00:00:10, 00:00:20, 00:01:00

00:02:00, 00:05:00, 00:10:00, 00:20:00, 01:00:00; 0.50 = 500 ms

Set Time



Select
Position
Digits
blinks



Change
Value



Acknowledge
Selection

Possible Settings

(hh:mm:ss, hh=hours, mm=minutes, ss=seconds)

Set Date



Select
Position



Change
Value



Acknowledge
Selection

Possible Settings

(TT:MM:JJ, TT=day, MM=month, JJ=year)

Set Device Address



Change
Value



Acknowledge
Address

Possible Settings (see also chapter 8.6): 0 ... 15

9 Characteristic Values

Measuring Function	Measuring Range	Resolution at Upper Range Limit	Open-circuit voltage approx.	Meas. current approx.
		4 $\frac{3}{4}$ 30000 / 3 $\frac{3}{4}$ 3000 ¹⁾		
mΩ (4 L)	30 m Ω	0.01 m Ω	4 ... 6 V	100 mA
	300 m Ω	0.01 m Ω		100 mA
	3 Ω	0.1 m Ω		10 mA
	30 Ω	1 m Ω		10 mA

- 1) Display:
 4 $\frac{3}{4}$ places in the range of 300 m Ω , 3 Ω , 30 Ω ,
 3 $\frac{3}{4}$ places in the range of 30 m Ω ,
 A different sampling rate can be selected in the rAtE menu for saving and transmitting measured values.

Measuring Function	Intrinsic Error at Max. Resolution under Reference Conditions		Overload Capacity ²⁾	
	$\pm(\dots\% \text{ rdg.} + \dots \text{ d})$		Value	Time
mΩ (4 L)	30 m Ω	2 + 20	$\pm 0.6 \text{ V}$ 3)	cont.
	300 m Ω	1 + 20 ⁴⁾		
	3 Ω	1 + 10		
	30 Ω	1 + 10		

- 2) at 0 ° ... + 40 °C
 3) In the event of an overload (connections I+, I-), the integrated 500 mA/600V fuse is triggered.
 4) applies as from 10% of the measuring range

EX parameters: $V_o = 6 \text{ V}$, $C_o = 559 \mu\text{F}$, $I_o = 576 \text{ mA}$,
 $L_o = 300 \mu\text{H}$, $P_o = 0,785 \text{ W}$

Key

rdg. = measured value, d = digit, 4 L = 4-wire measurement

Influencing Quantities and Influence Error

Influencing Quantity	Sphere of Influence	Measuring Range ¹⁾	Influence Error $\pm(\dots\% \text{ rdg.} + \text{d})/10 \text{ K}$
Temperature	0 ... +21 °C and +25...+40 °C	m Ω , Ω	1 + 10

- 1) With zero balancing

Influencing Quantity	Sphere of Influence	Measuring Range ¹⁾	Influence Error
Relative humidity	90 % 3 days instrument off	All measured quantities	1 x intrinsic error

- 1) With zero balancing

Real-Time Clock

Accuracy $\pm 1 \text{ min/month}$
 Temperature Influence 50 ppm/K

Reference Conditions

Ambient temperature +23 °C $\pm 2 \text{ K}$
 Relative humidity 40 ... 60 %
 Battery voltage 5.0 V $\pm 0.1 \text{ V}$

Response Time

Response time (after manual range selection)

Measuring Range	Response Time for Digital Display	Measured Quantity Step Function
m Ω , Ω	1.5 s	from ∞ to 50% of upper range limit value

* without parallel capacity

Display Elements

LCD panel (65 mm x 30 mm) with triple 7 segment display (measured values), units of measure and various special functions.

Display / Char. Height	7-segment characters Main display: 12 mm Auxiliary displays: 7 mm
Number of places	4¾ places \cong 30999 steps
Overflow display	„D.L.“ appears
LCD test	All display segments available during operation are briefly activated after the instrument is switched on
Background illumination	can be activated or deactivated
LED OK (green)	lights up when contacting of measuring point is OK
LED ERROR (red)	lights up when measuring current is interrupted (invalid measurement, poor contact, when „D.L.“ is displayed)

Power Supply

Batteries 4 x 1,5 V Philips Longlife R6L4B LR6 (AA-Size)

Service life

Measuring Function	Number of Measurements *
m Ω @100mA	> 500
Ω @10mA	> 800

* 1 measuring cycle = 5 s

Additional consumption for:

Interface operation:	0.5 mA
LCD illumination:	40 mA at 6 V.
Battery test	Range m Ω @100mA: “- ” is displayed automatically if battery voltage drops below approx. 4.6 V. The instrument is switched off if battery voltage drops to below approx. 4.3 V.

Fuses

Fusible link F1 for all m Ω / Ω measuring ranges	500 mA/600 V AC; breaking capacity 60 A at 600 V AC
For batteries F2	250 mA/125 V AC EX

Electrical Safety

Safety class	II per IEC/EN 61010-1:2010 /VDE 0411-1:2011
Measurement category	50 V CAT I
Contamination degree	2
EX marking	CE 0080  II 2 G Ex ia IIA T4 Gb EX = prototype tested II = Device group 2 = Device category G = Atmosphere (gas) Ex = conforms to European Ex standards ia = Type of protection (intrinsic safety) IIA = Explosion category T4 = Temperature class Gb = Equipment Protection Level (EPL)

Tamb. = -10 °C ... +50 °C

(Tamb. = ambient temperature)

Prototype test certificate	INERIS 05ATEX0040 INERIS = Inspection and Certification Authority 05 = Year ATEX = Guideline (Atmospheres Explosives) 0040 = Test Report No.
----------------------------	---

Serial number (fabrication number)

X Y 123456	X = year of manufacture: P=2005, Q=2006, R=2007, ... Y = month of manufacture January A February B March C April D May E June F July G August H September I October J November K December L 123456 = serial number
------------	--

PG123456 means for example = device was built in July 2005

Serial plate

GOSSSEN METRAWATT	manufacturer
Thomas-Mann-Str. 16-20	street
D-90471 Nürnberg	post code / place
METRA HIT 27EX	designation of device
INERIS 05ATEX0040	prototype test certificate see above
X Y 123456	serial number see above
 II 2 G	EX marking see above
EX ia IIA T4 Gb	EX marking see above
Tamb.= -10 °C ... +50 °C	ambient temperature

Electromagnetic Compatibility (EMC)

Interference emission	
Interference immunity	EN 61326-1:2006 Tab A1

Data Interface

Data transmission	bidirectional, optical via infrared light through the housing (read data and configure parameters)
-------------------	--

With interface adapter as accessory

BD232	IR to RS232C, serial, per DIN 19241, cascable for multi-channel operation
USB-HIT	IR to USB 1.1/USB 2.0, single-channel operation
baud rate (MM ↔ PC)	9600 baud

Ambient Conditions

Accuracy range	0 °C ... +40 °C
Operating temperatures	-10 °C ... +50 °C
Storage temperatures	-25 °C ... +70 °C (w/o batteries)
Relative humidity	45% ... 90%, no condensation allowed
Elevation	up to 2000 m

Mechanical Design

Protection	IP 54
------------	-------

Extract from table on the meaning of IP codes

IP XY (st digit X)	Protection against foreign object entry	IP XY (^{2nd} digit Y)	Protection against the penetration of water
5	dust protected	4	splashing water

Dimensions	84 mm x 195 mm x 35 mm
Weight	approx. 380 g with batteries (without GH18 protective rubber cover)

10 Maintenance

10.1 Batteries



Warning!

Ex Environment: Remove the instrument from the potentially explosive environment before opening.



Attention!

Non-Ex Environment: Disconnect the instrument from the measuring circuit before opening to replace batteries!

Removing the Batteries During Periods of Non-Use

The integrated quartz clock draws power from the batteries, even when the instrument is switched off. It is advisable to remove the batteries during long periods of non-use for this reason (e.g. vacation). This prevents excessive depletion of the batteries, which may result in damage under unfavorable conditions.

Checking Battery Voltage-Level and Condition

The current battery voltage level can be queried in the “Info” menu (see chapter 8 on page 17):

MENU/ESC + ON/OFF ▽△ InFO ▷ X.X V (bAtt).

Make sure that no battery leakage has occurred before initial start-up, and after long periods of storage. Continue to inspect the batteries for leakage at short, regular intervals.

- **If battery leakage has occurred**, carefully and completely clean electrolyte from the instrument with a damp cloth, and replace the batteries before using the instrument.
- **If the “-|” symbol appears at the display**, the batteries should be replaced as soon as possible. You can continue working with the instrument, but reduced measuring accuracy may result.

Replacing the Batteries



Warning!

Use the included type-tested batteries only, as described in the Characteristic Values.

- Set the instrument face down onto a flat working surface, loosen the two screws at the back and lift off the housing base, starting at the bottom. The housing top and housing base are held together with the help of snap hooks at the top front.
- Remove the batteries from the battery compartment.
- Insert four 1.5 V batteries into the battery compartment, making sure that the plus and minus poles match up with the provided polarity symbols.
- Important for reassembly: First set the housing base onto the housing top and align accurately (see photo below). Then press the two housing halves together, first at the bottom front (a), and then at the top front (b).



- Secure the housing base with the two screws.
-



Warning!

The instrument may not be operated if the housing base has not been properly installed and secured!

Disposing of Batteries

Dispose of old batteries properly, i.e. at a designated collection point.

10.2 Fuses

Inspecting the Integrated Fuse F1

The fuse F1 is located at the measuring input. When the fuse is defective, the measurements in the $m\Omega/\Omega$ ranges are faulty.

- Short circuit the two outer „I-“ and „I+“ jacks.
Display $< 0.4 \Omega$: fuse OK.
Display „OL“ and „oPErT“: fuse blown.
-



Attention!

If a fuse should blow, eliminate the cause of overload before placing the instrument back into service!

Inspecting the Integrated Fuse F2

The fuse F2 is located in the battery supply path. If the LC display is not active upon switching the instrument on:

- ⇒ check whether the batteries have been inserted with the polarity symbols at the correct end.

If the LCD remains inactive it might be defective.

Replacing the Fuses

Fuse F1 for the $m\Omega/\Omega$ measuring ranges and fuse F2 for the battery power supply are both firmly soldered in. They are not intended to be replaced by the user.

If one of the fuses is defective, you are requested to send the instrument to our repair service or to the respective subsidiary abroad (the address is given in chapter 12). This provides you with the guarantee that type-tested and/or Ex-approved fuses with the correct triggering characteristics, nominal current and breaking capacity are inserted. Additionally, the instrument will be subjected to a safety test.

Instructions for the service



Warning!

Ex Environment: Remove the instrument from the potentially explosive environment before opening.



Attention!

Non-Ex Environment: Disconnect the instrument from the measuring circuit before opening to replace batteries!

- ⇒ Open the instrument in the same manner as for replacing the batteries.
-



Warning!

Use the specified type-tested fuses only! If fuses with other blowing characteristics, other current ratings or other breaking capacities are used, the operator is placed in danger, and protective diodes, resistors and other components may be damaged. The use of repaired fuses and short-circuiting the fuse holder are prohibited.

10.3 Housing and Display

No special maintenance is required for the housing. Keep outside surfaces clean. Use a cloth slightly dampened with water for cleaning.

Attention ! Do not under any circumstances use cleansers, abrasives and solvents !

This particularly applies to the display surface to avoid damaging the high-quality explosion protection coating, thus reducing its efficiency.

10.4 Collection of Used Instruments and Environmentally Compatible Disposal

The milliohmmeter is a category 9 product (monitoring and control instrument) in accordance with ElektroG (*German Electrical and Electronic Device Law*). This device is subject to the RoHS Directive. Further-more, we make reference to the fact that the current status in this regard can be accessed on the Internet at www.gossenmetrawatt.com by entering the search term WEEE.

We identify our electrical and electronic devices in accordance with WEEE 2012/19EU and ElektroG with the symbol shown to the right per DIN EN 50419. These devices may not be disposed with the trash. Please contact our service department regarding the return of old devices. (see chapter 12).



If you use type-tested **batteries** in your instrument or accessories which no longer function properly, they must be duly disposed of in compliance with the applicable national regulations.

Batteries or rechargeable batteries may contain harmful substances or heavy metal such as lead (Pb), cadmium (Cd) or mercury (Hg).

The symbol shown to the right indicates that batteries or rechargeable batteries may not be disposed of with the trash, but must be delivered to collection points specially provided for this purpose.



11 System Messages

The following messages appear at the main display, or the auxiliary displays as required. See “Symbols used in the Digital Display” on page 3 for messages displayed at visible segments.

Message	Function	Meaning
$\square . L$	Measuring	Indicates overflow
$\square PE_n L$	4-wire- $m\Omega$	Measuring current interrupted or fuse defective.

Blinking Unit of Measure

All measuring functions are balanced for each METRA HIT | 27EX at the factory in accordance with the respective technical specification. If a unit of measure blinks, this indicates that balancing constants which have been established and saved to the milliohmmeter are no longer available for the respective function. If this is the case, measurement results may deviate from the specification. We recommend sending the instrument to our Repair and Replacement Parts department for rebalancing (see chapter 12).

12 Repair and Replacement Parts Service, Calibration Center* and Rental Instrument Service

If required please contact:

GMC-I Service GmbH
Service Center
Thomas-Mann-Straße 20
90471 Nürnberg • Germany
Phone +49 911 817718-0
Fax +49 911 817718-253
E-Mail service@gossenmetrawatt.com
www.gmci-service.com

This address is only valid in Germany.
Please contact our representatives or subsidiaries for service in other countries.

French subsidiary:
GMC Instruments France SAS
3, rue René Cassin
F-91349 Massy Cedex
Phone +33 1 69 20 89 49
Fax +33 1 69 20 54 92
E-mail info@gmc-instruments.fr

* **DAkkS Calibration Laboratory for Electrical Quantities D-K-15080-01 accredited as per DIN EN ISO/IEC 17025:2005**

Accredited quantities: direct voltage, DC value, DC resistance, alternating voltage, AC value, AC active power, AC apparent power, DC power, capacitance, frequency and temperature

Competent Partner

GMC-I Messtechnik GMBH is certified per DIN EN ISO 9001:2008.

Our DAkkS Calibration Laboratory has been accredited in accordance with DIN EN ISO/IEC 17025:2005 by the Deutsche Kalibrierdienst (*German Calibration Service*) under registration number D-K-15080-01-01.

Our competence in the field of metrology covers **test reports, Proprietary Calibration Certificates** as well as **DAkkS Calibration Certificates**.

Our range of services is complemented by our **Test Equipment Management** service which is provided free of charge. An on-site **DAkkS calibration station** is an integral part of our service department. If any faults are detected during calibration, our specialists are able to carry out the necessary repairs with original replacement parts.

Needless to say, in our function as calibration laboratory, we calibrate all instruments, irrespective of the manufacturer.

13 Manufacturer's Guarantee

The guarantee period for all METRA HIT digital multimeters and calibration instruments is 3 years after date of shipment.

The guarantee covers materials and workmanship. Damage resulting from use for any other than the intended purpose or operating errors, as well as any and all consequential damage, is excluded.

The calibration certificate confirms that the product conformed to the specified technical data at the time of calibration. We guarantee the observance of the specified technical data within the admissible tolerance limits for a period of 12 months from delivery.

14 Product Support

If required please contact:

GMC-I Messtechnik GMBH

Product Support Hotline

Phone +49 911 8602-0

Fax +49 911 8602-709

E-Mail support@gossenmetrawatt.com

French subsidiary:

GMC Instruments France SAS

3, rue René Cassin

F-91349 Massy Cedex

Phone +33 1 69 20 89 49

Fax +33 1 69 20 54 92

E-mail info@gmc-instruments.fr

15 Recalibration

The respective measuring task and the stress to which your measuring instrument is subjected affect the ageing of the components and may result in deviations from the guaranteed accuracy.

If high measuring accuracy is required and the instrument is frequently used in field applications, combined with transport stress and great temperature fluctuations, we recommend a relatively short calibration interval of 1 year. If your measuring instrument is mainly used in the laboratory and indoors without being exposed to any major climatic or mechanical stress, a calibration interval of 2-3 years is usually sufficient.

During recalibration* in an accredited calibration laboratory (DIN EN ISO/IEC 17025) the deviations of your instrument in relation to traceable standards are measured and documented. The deviations determined in the process are used for correction of the readings during subsequent application.

We are pleased to perform DAkkS or factory calibrations for you in our calibration laboratory. Please visit our website at

www.gossenmetrawatt.com (→ Company → DAkkS Calibration Center or → FAQs → Calibration questions and answers).

By having your measuring instrument calibrated regularly, you fulfill the requirements of a quality management system per DIN EN ISO 9001.

* Verification of specifications or adjustment services are not part of the calibration. For products from our factory, however, any necessary adjustment is frequently performed and the observance of the relevant specification is confirmed.

Edited in Germany • Subject to change without notice

 **GOSSEN METRAWATT**

GMC-I Messtechnik GMBH

Südwestpark 15

90449 Nürnberg • Germany

Phone +49 911 8602-111

Fax +49 911 8602-777

E-Mail info@gossenmetrawatt.com

www.gossenmetrawatt.com