



**EurotestXC**  
**MI 3152**  
**EurotestXC 2,5 kV**  
**MI 3152H**  
**Instruction manual**  
*Version 1.2.2, Code no. 20 752 411*

**Distributor:**

**Manufacturer:**

METREL d.d.  
Ljubljanska cesta 77  
1354 Horjul  
Slovenia  
web site: <http://www.metrel.si>  
e-mail: [metrel@metrel.si](mailto:metrel@metrel.si)



Mark on your equipment certifies that this equipment meets the requirements of the EU (European Union) concerning safety and electromagnetic compatibility regulations

© 2015 METREL

*The trade names Metrel, Smartec, Eurotest, Autosequence are trademarks registered or pending in Europe and other countries.*

No part of this publication may be reproduced or utilized in any form or by any means without permission in writing from METREL.

# Table of Contents

<b>1</b>	<b>General description</b>	<b>7</b>
1.1	Warnings and notes	7
1.1.1	<i>Safety warnings</i>	7
1.1.2	<i>Markings on the instrument</i>	8
1.1.3	<i>Warnings related to safety of batteries</i>	8
1.1.4	<i>Warnings related to safety of measurement functions</i>	8
1.1.5	<i>Notes related to measurement functions</i>	9
1.2	Testing potential on PE terminal	11
1.3	Battery and charging	13
1.4	Standards applied	14
<b>2</b>	<b>Instrument set and accessories</b>	<b>15</b>
2.1	Standard set MI 3152 EurotestXC	15
2.2	Standard set MI 3152H EurotestXC 2,5 kV	15
2.2.1	<i>Optional accessories</i>	15
<b>3</b>	<b>Instrument description</b>	<b>16</b>
3.1	Front panel	16
3.2	Connector panel	17
3.3	Back side	18
3.4	Carrying the instrument	20
3.4.1	<i>Secure attachment of the strap</i>	20
<b>4</b>	<b>Instrument operation</b>	<b>22</b>
4.1	General meaning of keys	22
4.2	General meaning of touch gestures	23
4.3	Virtual keyboard	24
4.4	Display and sound	25
4.4.1	<i>Terminal voltage monitor</i>	25
4.4.2	<i>Battery indication</i>	26
4.4.3	<i>Measurement actions and messages</i>	26
4.4.4	<i>Result indication</i>	28
4.5	Instruments main menu	29
4.6	General Settings	30
4.6.1	<i>Language</i>	30
4.6.2	<i>Power Save</i>	31
4.6.3	<i>Date and time</i>	31
4.6.4	<i>Settings</i>	32
4.6.5	<i>Initial Settings</i>	34
4.6.6	<i>About</i>	35
4.7	Instrument profiles	36
4.8	Workspace Manager menu	37
4.8.1	<i>Workspaces and Exports</i>	37
4.8.2	<i>Workspace Manager main menu</i>	37
4.8.3	<i>Operations with Workspaces</i>	38
4.8.4	<i>Operations with Exports</i>	38
4.8.5	<i>Adding a new Workspace</i>	40
4.8.6	<i>Opening a Workspace</i>	41
4.8.7	<i>Deleting a Workspace / Export</i>	41
4.8.8	<i>Importing a Workspace</i>	42

4.8.9	Exporting a Workspace .....	43
<b>5</b>	<b>Memory Organizer .....</b>	<b>44</b>
5.1	Memory Organizer menu.....	44
5.1.1	Measurement statuses .....	44
5.1.2	Structure Objects.....	45
5.1.3	Operations in Tree menu.....	46
<b>6</b>	<b>Single tests.....</b>	<b>65</b>
6.1	Selection modes .....	65
6.1.1	Single test screens .....	66
6.1.2	Setting parameters and limits of single tests .....	68
6.1.3	Single test start screen.....	69
6.1.4	Single test screen during test.....	70
6.1.5	Single test result screen .....	71
6.1.6	Editing graphs (Harmonics).....	73
6.1.7	Help screens.....	74
6.1.8	Recall single test results screen.....	75
<b>7</b>	<b>Tests and measurements .....</b>	<b>76</b>
7.1	Voltage, frequency and phase sequence.....	76
7.2	R iso – Insulation resistance .....	78
7.3	The DAR and PI diagnostic (MI 3152H only) .....	80
7.4	R low – Resistance of earth connection and equipotential bonding.....	82
7.5	Continuity – Continuous resistance measurement with low current.....	84
7.5.1	Compensation of test leads resistance .....	85
7.6	Testing RCDs .....	87
7.6.1	RCD $U_c$ – Contact voltage .....	88
7.6.2	RCD $t$ – Trip-out time.....	89
7.6.3	RCD $I$ – Trip-out current .....	90
7.7	RCD Auto – RCD Auto test .....	91
7.8	Z loop – Fault loop impedance and prospective fault current.....	93
7.9	Zs rcd – Fault loop impedance and prospective fault current in system with RCD.....	95
7.10	Z loop m $\Omega$ – High precision fault loop impedance and prospective fault current.....	97
7.11	Z line – Line impedance and prospective short-circuit current .....	99
7.12	Z line m $\Omega$ – High precision line impedance and prospective short-circuit current ....	101
7.13	Voltage Drop.....	104
7.14	Earth – Earth resistance (3-wire test).....	107
7.15	Earth 2 clamp – Contactless earthing resistance measurement (with two current clamps) .....	109
7.16	Ro – Specific earth resistance.....	111
7.17	Power.....	113
7.18	Harmonics.....	115
7.19	Currents .....	117
7.20	ISFL – First fault leakage current (MI 3152 only).....	119
7.21	IMD – Testing of insulation monitoring devices (MI 3152 only) .....	121
7.22	Rpe – PE conductor resistance.....	124
7.23	Illumination.....	126
<b>8</b>	<b>Auto tests .....</b>	<b>128</b>
8.1	AUTO TT – Auto test sequence for TT earthing system .....	129
8.2	AUTO TN (RCD) – Auto test sequence for TN earthing system with RCD.....	131
8.3	AUTO TN – Auto test sequence for TN earthing system without RCD .....	133
8.4	AUTO IT – Auto test sequence for IT earthing system (MI 3152 only) .....	135

<b>9</b>	<b>Communication</b> .....	<b>137</b>
9.1	USB and RS232 communication.....	137
9.2	Bluetooth communication.....	137
<b>10</b>	<b>Upgrading the instrument</b> .....	<b>139</b>
<b>11</b>	<b>Maintenance</b> .....	<b>140</b>
11.1	Fuse replacement.....	140
11.2	Cleaning.....	140
11.3	Periodic calibration.....	141
11.4	Service.....	141
<b>12</b>	<b>Technical specifications</b> .....	<b>142</b>
12.1	R iso – Insulation resistance.....	142
12.2	Diagnostic test (MI 3152H only).....	143
12.3	R low – Resistance of earth connection and equipotential bonding.....	144
12.4	Continuity – Continuous resistance measurement with low current.....	144
12.5	RCD testing.....	145
12.5.1	RCD $U_c$ – Contact voltage.....	145
12.5.2	RCD $t$ – Trip-out time.....	146
12.5.3	RCD $I$ – Trip-out current.....	146
12.6	Z loop – Fault loop impedance and prospective fault current.....	147
12.7	Zs rcd – Fault loop impedance and prospective fault current in system with RCD....	147
12.8	Z line – Line impedance and prospective short-circuit current.....	148
12.9	Voltage Drop.....	148
12.10	Rpe – PE conductor resistance.....	149
12.11	Earth – Earth resistance (3-wire measurement).....	150
12.12	Earth 2 clamp – Contactless earthing resistance measurement (with two current clamps).....	150
12.13	Ro – Specific earth resistance.....	151
12.14	Voltage, frequency, and phase rotation.....	152
12.14.1	Phase rotation.....	152
12.14.2	Voltage.....	152
12.14.3	Frequency.....	152
12.14.4	Online terminal voltage monitor.....	152
12.15	Currents.....	153
12.16	Power.....	154
12.17	Harmonics.....	154
12.18	ISFL – First fault leakage current (MI 3152 only).....	155
12.19	IMD (MI 3152 only).....	155
12.20	Illumination.....	156
12.21	General data.....	157
<b>Appendix A</b>	<b>Fuse table – IPSC</b> .....	<b>158</b>
<b>Appendix B</b>	<b>Profile Notes</b> .....	<b>162</b>
B.1	Profile Austria (ALAJ).....	162
B.2	Profile Finland (profile code ALAC).....	163
B.3	Profile Hungary (profile code ALAD).....	167
B.4	Profile Switzerland (profile code ALAI).....	169
B.5	Profile UK (profile code ALAB).....	169
B.6	Profile AUS/NZ (profile code ALAE).....	169
<b>Appendix C</b>	<b>Commanders (A 1314, A 1401)</b> .....	<b>170</b>
C.1	 Warnings related to safety.....	170

C.2	Battery.....	170
C.3	Description of commanders.....	170
C.4	Operation of commanders.....	171
<b>Appendix D – Structure objects.....</b>		<b>172</b>

# 1 General description

## 1.1 Warnings and notes





### 1.1.1 Safety warnings

In order to reach high level of operator safety while carrying out various measurements using the EurotestXC instrument, as well as to keep the test equipment undamaged, it is necessary to consider the following general warnings:

- › **Read this user manual carefully, otherwise the use of the instrument may be dangerous for the operator, the instrument or for the equipment under test!**
- › **Consider warning markings on the instrument (see next chapter for more information).**
- › **If the test equipment is used in a manner not specified in this user manual, the protection provided by the equipment could be impaired!**
- › **Do not use the instrument or any of the accessories if any damage is noticed!**
- › **Consider all generally known precautions in order to avoid risk of electric shock while dealing with hazardous voltages!**
- › **Use only standard or optional test accessories supplied by your distributor!**
- › **In case a fuse has blown follow the instructions in this manual in order to replace it! Use only fuses that are specified!**
- › **Service, calibration or adjustment of instruments and accessories is only allowed to be carried out by a competent authorized person!**
- › **Do not use the instrument in AC supply systems with voltages higher than 550 V.a.c.**
- › **Consider that protection category of some accessories is lower than of the instrument. Test tips and Tip commander have removable caps. If they are removed the protection falls to CAT II. Check markings on accessories!**
  - **cap off, 18 mm tip: CAT II up to 1000 V**
  - **cap on, 4 mm tip: CAT II 1000 V / CAT III 600 V / CAT IV 300 V**
- › **The instrument comes supplied with rechargeable Ni-MH battery cells. The cells should only be replaced with the same type as defined on the battery compartment label or as described in this manual. Do not use standard alkaline battery cells while the power supply adapter is connected, otherwise they may explode!**
- › **Hazardous voltages exist inside the instrument. Disconnect all test leads, remove the power supply cable and switch off the instrument before removing battery compartment cover.**
- › **Do not connect any voltage source on C1/C2 inputs. It is intended only for connection of current clamps. Maximal input voltage is 3 V!**

### 1.1.2 Markings on the instrument

- ›  Read the Instruction manual with special care to safety operation«. The symbol requires an action!
- ›  Mark on your equipment certifies that it meets European Union requirements for EMC, LVD, and ROHS regulations.
- ›  This equipment should be recycled as electronic waste.

### 1.1.3 Warnings related to safety of batteries

- › When connected to an installation, the instruments battery compartment can contain hazardous voltage inside! When replacing battery cells or before opening the battery/fuse compartment cover, disconnect any measuring accessory connected to the instrument and turn off the instrument,
- › Ensure that the battery cells are inserted correctly otherwise the instrument will not operate and the batteries could be discharged.
- › Do not recharge alkaline battery cells!
- › Use only power supply adapter delivered from the manufacturer or distributor of the test equipment!

### 1.1.4 Warnings related to safety of measurement functions

#### Insulation resistance

- › Insulation resistance measurement should only be performed on de-energized objects!
- › Do not touch the test object during the measurement or before it is fully discharged! Risk of electric shock!

#### Continuity functions

- › Continuity measurements should only be performed on de-energized objects!



## 1.1.5 Notes related to measurement functions

### Insulation resistance

- › The measuring range is decreased if using Plug commander.
- › If a voltage of higher than 30 V (AC or DC) is detected between test terminals, the measurement will not be performed.

### Diagnostic test

- › If any insulation resistance values ( $R_{ISO}(15\text{ s})$  or  $R_{ISO}(60\text{ s})$ ) are over-ranged the **DAR** factor is not calculated. The result field is blank: DAR: \_\_\_\_\_!
- › If any insulation resistance values ( $R_{ISO}(60\text{ s})$  or  $R_{ISO}(10\text{ min})$ ) are over-ranged the **PI** factor is not calculated. The result field is blank: PI : \_\_\_\_\_!

### R low, Continuity

- › If a voltage of higher than 10 V (AC or DC) is detected between test terminals, the measurement will not be performed.
- › Parallel loops may influence on test results.

### Earth, Earth 2 clamp, Ro

- › If voltage between test terminals is higher than 10 V (Earth, Earth 2 clamps) or 30 V (Ro) the measurement will not be performed.
- › Contactless earthing resistance measurement (using two current clamps) enables simple testing of individual earthing rods in large earthing system. It is especially suitable for use in urban areas because there is usually no possibility to place the test probes.
- › For two clamps earth resistance measurement clamps A 1018 and A 1019 should be used. Clamps A 1391 are not supported. The distance between clamps should be at least 30 cm.
- › For specific earth resistance measurements  $\rho$  Adaptor A 1199 should be used.

### RCD t, RCD I, RCD Uc, RCD Auto

- › Parameters set in one function are also kept for other RCD functions!
- › Selective (time-delayed) RCDs have delayed response characteristics. As the contact voltage pre-test or other RCD tests influence the time delayed RCD it takes a certain period to recover into normal state. Therefore a time delay of 30 s is inserted before performing trip-out test by default.
- › Portable RCDs (PRCD, PRCD-K and PRCD-S) are tested as general (non-delayed) RCDs. Trip-out times, trip-out currents and contact voltage limits are equal to limits of general (non-delayed) RCDs.
- › The Zs rcd function takes longer to complete but offers much better accuracy of fault loop resistance (in comparison to the  $R_L$  sub-result in Contact voltage function).
- › Auto test is finished without x5 tests in case of testing the RCD types A, F, B and B+ with rated residual currents of  $I_{dN} = 300\text{ mA}$ ,  $500\text{ mA}$ , and  $1000\text{ mA}$  or testing the RCD type AC with rated residual current of  $I_{dN} = 1000\text{ mA}$ . In this case Auto test result passes if all other results pass, and indications for x5 are omitted.
- › Auto test is finished without x1 tests in case of testing the RCD types B and B+ with rated residual currents of  $I_{dN} = 1000\text{ mA}$ . In this case Auto test result passes if all other results pass, and indications for x1 are omitted (MI 3152 only).
- › Tests for sensitivity  $I_{dn}(+)$  and  $I_{dn}(-)$  are omitted for selective type RCD.
- › Trip out time measurement for B and B+ type RCDs in AUTO function is made with sine-wave test current, while trip-out current measurement is made with DC test current (MI 3152 only).

**Z loop, Zs rcd**

- › The specified accuracy of tested parameters is valid only if the mains voltage is stable during the measurement.
- › Fault loop impedance (Z loop) measurements will trip an RCD.
- › The Zs rcd measurement does not normally trip an RCD. However, the RCD can trip if a leakage current from L to PE already flows.

**Z line, Voltage drop**

- › In case of measurement of  $Z_{\text{Line-Line}}$  with the instrument test leads PE and N connected together the instrument will display a warning of dangerous PE voltage. The measurement will be performed anyway.
- › Specified accuracy of tested parameters is valid only if mains voltage is stable during the measurement.
- › If the reference impedance is not set the value of  $Z_{\text{REF}}$  is considered as 0.00  $\Omega$ .

**Power, Harmonics, Currents**

- › Consider polarity of current clamp (arrow on test clamp should be oriented toward connected load), otherwise result will be negative!

**Illumination**

- › LUXmeter type B and LUXmeter type C probes are supported by the instrument.
- › Artificial light sources reach full power of operation after a period of time (see technical data for light sources) and should be therefore switched on for this period of time before the measurements are taken.
- › For accurate measurement make sure that the milk glass bulb is lit without any shadows cast by hand, body or other unwanted objects.
- › Refer to the Illuminance handbook for more information.

**Rpe**

- › The specified accuracy of tested parameters is valid only if the mains voltage is stable during the measurement.
- › Measurement will trip an RCD if the parameter RCD is set to 'No'.
- › The measurement does not normally trip an RCD if the parameter RCD is set to 'Yes'. However, the RCD can trip if a leakage current from L to PE already flows.

**IMD**

- › It is recommended to disconnect all appliances from the tested supply to receive regular test results. Any connected appliance will influence the insulation resistance threshold test.

**Z line m $\Omega$ , Z loop m $\Omega$** 

- › A 1143 Euro Z 290 A adapter is required for this measurements.

**Auto Tests**

- › Voltage drop (dU) measurement in each Auto test sequence is enabled only if  $Z_{\text{REF}}$  is set.
- › See other notes related to single tests / measurements of selected Auto test sequence.

## 1.2 Testing potential on PE terminal

In certain instances faults on the installation's PE wire or any other accessible metal bonding parts can become exposed to live voltage. This is a very dangerous situation since the parts connected to the earthing system are considered to be free of potential. In order to properly

check the installation against this fault the  key should be used as an indicator prior to performing live tests.

### Examples for application of PE test terminal

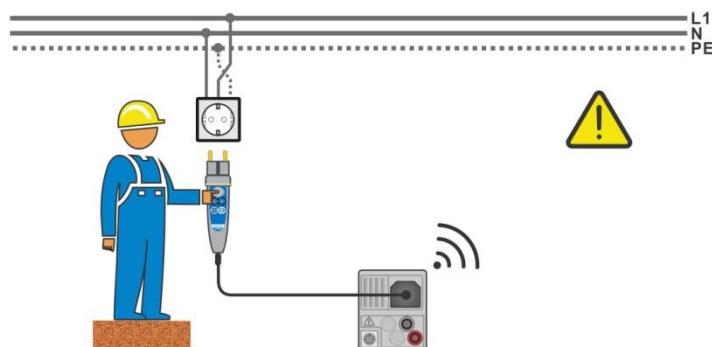

Figure 1.1: Reversed L and PE conductors (plug commander)

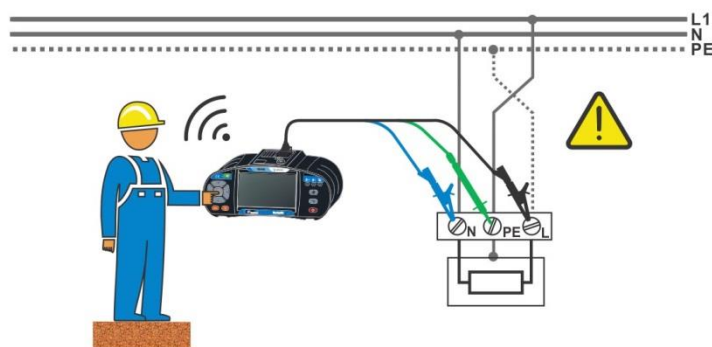

Figure 1.2: Reversed L and PE conductors (application of 3-wire test lead)

### Warning!



#### Reversed phase and protection conductors! The most dangerous situation!

If dangerous voltage is detected on the tested PE terminal, stop all measurements immediately and ensure the cause of the fault is eliminated before proceeding with any activity!

### Test procedure

- 
- › Connect test cable to the instrument.
  - › Connect test leads to the object under test, see **Figure 1.1** and **Figure 1.2**.
- 
- › Touch  test probe for at least 2 seconds.  
If PE terminal is connected to phase voltage the warning message is displayed, instrument buzzer is activated and further measurements are disabled in Z loop, Zs rcd, RCD tests and Auto test sequences.
- 

**Notes**

- › PE test terminal is active in the RCD tests, Z loop, Zs rcd, Z line, dU and Voltage measurements and Auto test sequences only!
- › For correct testing of PE terminal, the  key has to be touched for at least 2 seconds.
- › Make sure to stand on non-isolated floor while carrying out the test, otherwise test result may be wrong!

## 1.3 Battery and charging

The instrument uses six AA size alkaline or rechargeable Ni-MH battery cells. Nominal operating time is declared for cells with nominal capacity of 2100 mAh. Battery condition is always displayed in the upper right display part. In case the battery is too weak the instrument will be turned off automatically.

The battery is charged whenever the power supply adapter is connected to the instrument. Internal circuit controls charging and assures maximum battery lifetime.

Refer to chapters **3.2 Connector panel** and **4.4.2 Battery indication** for power socket polarity and battery indication.

### Notes:

- The charger in the instrument is a pack cell charger. This means that the battery cells are connected in series during the charging. The battery cells have to be equivalent (same charge condition, same type and age).
- If the instrument is not to be used for a long period of time, remove all batteries from the battery compartment.
- Alkaline or rechargeable Ni-MH batteries (size AA) can be used. METREL recommends only using rechargeable batteries with a capacity of 2100 mAh or above.
- Unpredictable chemical processes can occur during the charging of battery cells that have been left unused for a longer period (more than 6 months). In this case METREL recommends repeating the charge/discharge cycle at least 2-4 times.
- If no improvement is achieved after several charge / discharge cycles, then each battery cell should be checked (by comparing battery voltages, testing them in a cell charger, etc). It is very likely that only some of the battery cells are deteriorated. One different battery cell can cause an improper behaviour of the entire battery pack!
- The effects described above should not be confused with the normal decrease of battery capacity over time. Battery also loses some capacity when it is repeatedly charged / discharged. This information is provided in the technical specification from battery manufacturer.

## 1.4 Standards applied

The EurotestXC instruments are manufactured and tested in accordance with the following regulations:

---

### **Electromagnetic compatibility (EMC)**

EN 61326-1 Electrical equipment for measurement, control and laboratory use – EMC requirements  
Class B (Hand-held equipment used in controlled EM environments)

---

### **Safety (LVD)**

EN 61010-1 Safety requirements for electrical equipment for measurement, control and laboratory use – Part 1: General requirements

EN 61010-2-030 Safety requirements for electrical equipment for measurement, control and laboratory use – Part 2-030: Particular requirements for testing and measuring circuits

EN 61010-031 Safety requirements for electrical equipment for measurement, control and laboratory use – Part 031: Safety requirements for hand-held probe assemblies for electrical measurement and test

EN 61010-2-032 Safety requirements for electrical equipment for measurement, control, and laboratory use - Part 2-032: Particular requirements for hand-held and hand-manipulated current sensors for electrical test and measurement

---

### **Functionality**

EN 61557 Electrical safety in low voltage distribution systems up to 1000 V<sub>AC</sub> and 1500 V<sub>AC</sub> – Equipment for testing, measuring or monitoring of protective measures  
Part 1: General requirements  
Part 2: Insulation resistance  
Part 3: Loop resistance  
Part 4: Resistance of earth connection and equipotential bonding  
Part 5: Resistance to earth  
Part 6: Residual current devices (RCDs) in TT and TN systems  
Part 7: Phase sequence  
Part 10: Combined measuring equipment  
Part 12: Performance measuring and monitoring devices (PMD)

DIN 5032 Photometry  
Part 7: Classification of illuminance meters and luminance meters

---

### **Reference standards for electrical installations and components**

EN 61008 Residual current operated circuit-breakers without integral overcurrent protection for household and similar uses

EN 61009 Residual current operated circuit-breakers with integral overcurrent protection for household and similar uses

IEC 60364-4-41 Electrical installations of buildings Part 4-41 Protection for safety – protection against electric shock

BS 7671 IEE Wiring Regulations (17<sup>th</sup> edition)

AS/NZS 3017 Electrical installations – Verification guidelines

---

## 2 Instrument set and accessories

### 2.1 Standard set MI 3152 EurotestXC

- Instrument MI 3152 EurotestXC
- Soft carrying bag
- Earth set 3-wire, 20 m
- Plug commander
- Test lead, 3 x 1.5 m
- Test probe, 3 pcs
- Crocodile clip, 3 pcs
- Set of carrying straps
- RS232-PS/2 cable
- USB cable
- Set of Ni-MH battery cells
- Power supply adapter
- CD with instruction manual, "Guide for testing and verification of low voltage installations" handbook and PC software Metrel ES Manager.
- Short instruction manual
- Calibration Certificate

### 2.2 Standard set MI 3152H EurotestXC 2,5 kV

- Instrument MI 3152H EurotestXC 2,5 kV
- Soft carrying bag
- Earth set 3-wire, 20 m
- Plug commander
- Test lead, 3 x 1.5 m
- 2.5 kV test lead, 2 x 1.5 m
- Test probe, 3 pcs
- Crocodile clip, 3 pcs
- Set of carrying straps
- RS232-PS/2 cable
- USB cable
- Set of Ni-MH battery cells
- Power supply adapter
- CD with instruction manual, "Guide for testing and verification of low voltage installations" handbook and PC software Metrel ES Manager.
- Short instruction manual
- Calibration Certificate

#### 2.2.1 Optional accessories

See the attached sheet for a list of optional accessories that are available on request from your distributor.

## 3 Instrument description

### 3.1 Front panel



Figure 3.1: Front panel

1	<b>4,3" COLOR TFT DISPLAY WITH TOUCH SCREEN</b>
2	<b>SAVE key</b> Stores actual measurement result(s)
3	<b>CURSOR keys</b> Navigate in menus
4	<b>RUN key</b> Start / stop selected measurement. Enter selected menu or option. View available values for selected parameter / limit.
5	<b>OPTIONS key</b> Show detailed view of options.
6	<b>ESC key</b> Back to previous menu.
7	<b>ON / OFF key</b> Switch instrument on / off. The instrument automatically switches off after 10 minutes of idle state (no key pressed or any touchscreen activity) Press and hold the key for 5 s to switch off the instrument.
8	<b>GENERAL SETTINGS key</b> Enter General settings menu.
9	<b>BACKLIGHT key</b> Toggle screen brightness between high and low intensity.
10	<b>MEMORY ORGANIZER key</b> Shortcut key to enter Memory organizer menu.
11	<b>SINGLE TESTS key</b> Shortcut key to enter Single Tests menu.
12	<b>AUTO TESTS key</b> Shortcut key to enter Auto Tests menu.



## 3.2 Connector panel

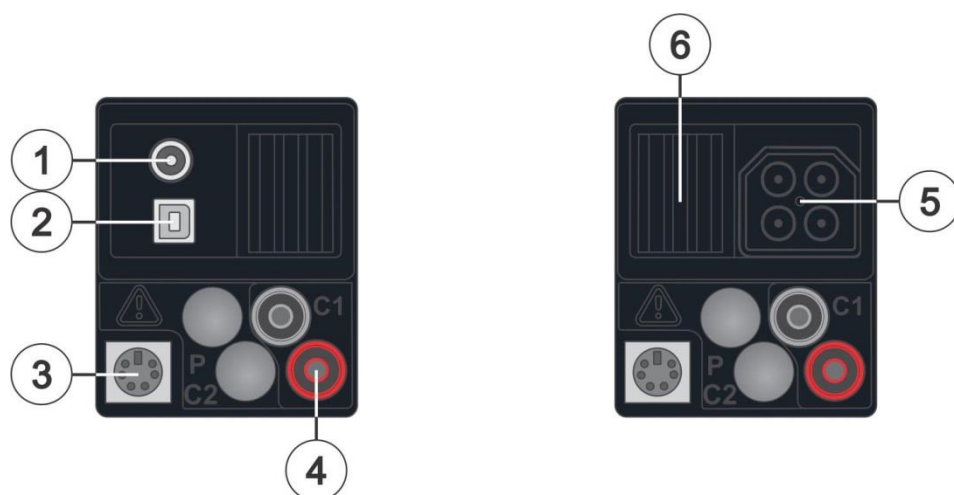

Figure 3.2: Connector panel

---

### 1 Charger socket



---

### 2 USB communication port

Communication with PC USB (1.1) port

---

### 3 PS/2 communication port

Communication with PC RS232 serial port  
Connection to optional measuring adapters  
Connection to barcode / RFID reader

---

### 4 C1 inputs

Current clamp measuring input

---

### 5 Test connector

---

### 6 Protection cover

---



### Warnings!

- › Maximum allowed voltage between any test terminal and ground is 550 V!
- › Maximum allowed voltage between test terminals on test connector is 550 V!
- › Maximum allowed voltage on test terminal C1 is 3 V!
- › Maximum short-term voltage of external power supply adapter is 14 V!

### 3.3 Back side

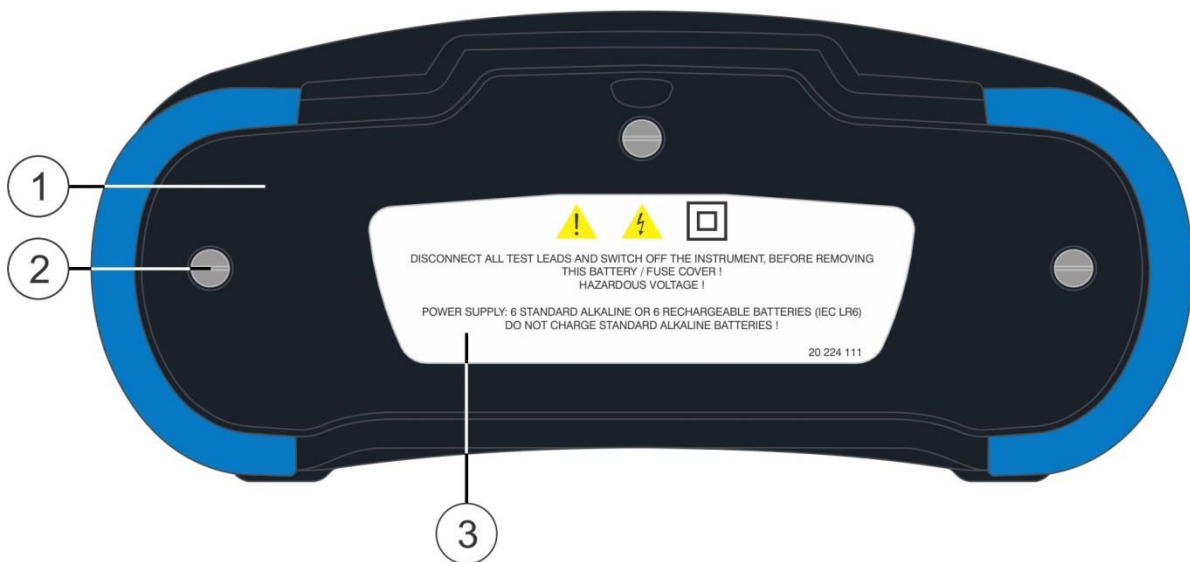

Figure 3.3: Back view

1	Battery / fuse compartment cover
2	Fixing screws for battery / fuse compartment cover
3	Back panel information label

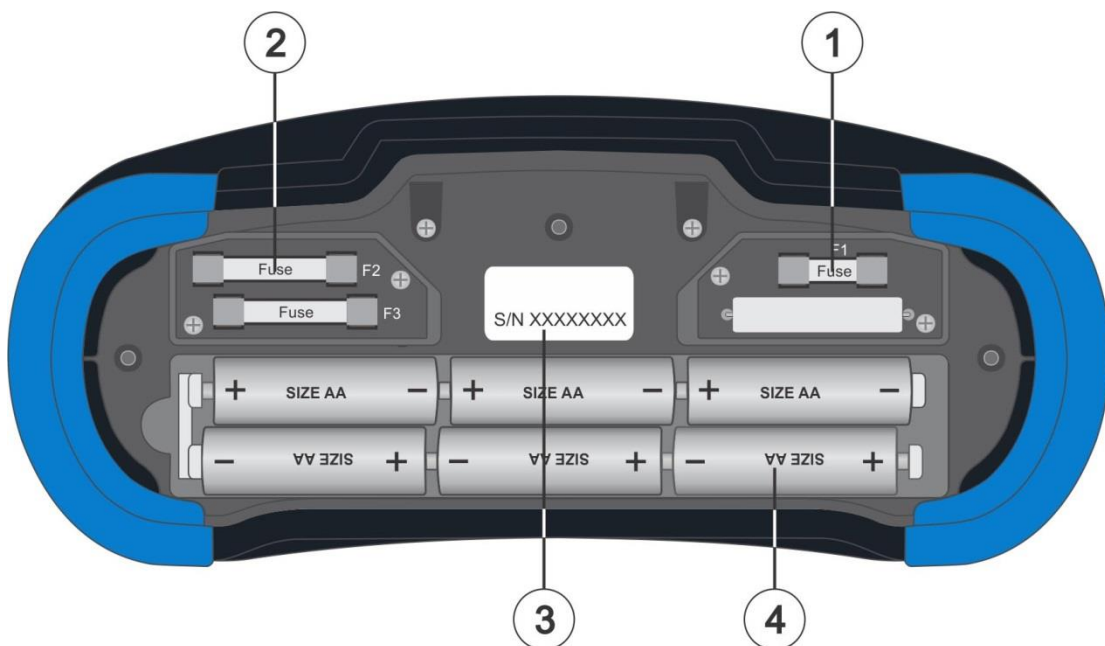

Figure 3.4: Battery and fuse compartment

1	<b>Fuse F1</b> M 315 mA / 250 V
2	<b>Fuses F2 and F3</b> F 4 A / 500 V (breaking capacity 50 kA)
3	<b>Serial number label</b>
4	<b>Battery cells</b> Size AA, alkaline / rechargeable NiMH

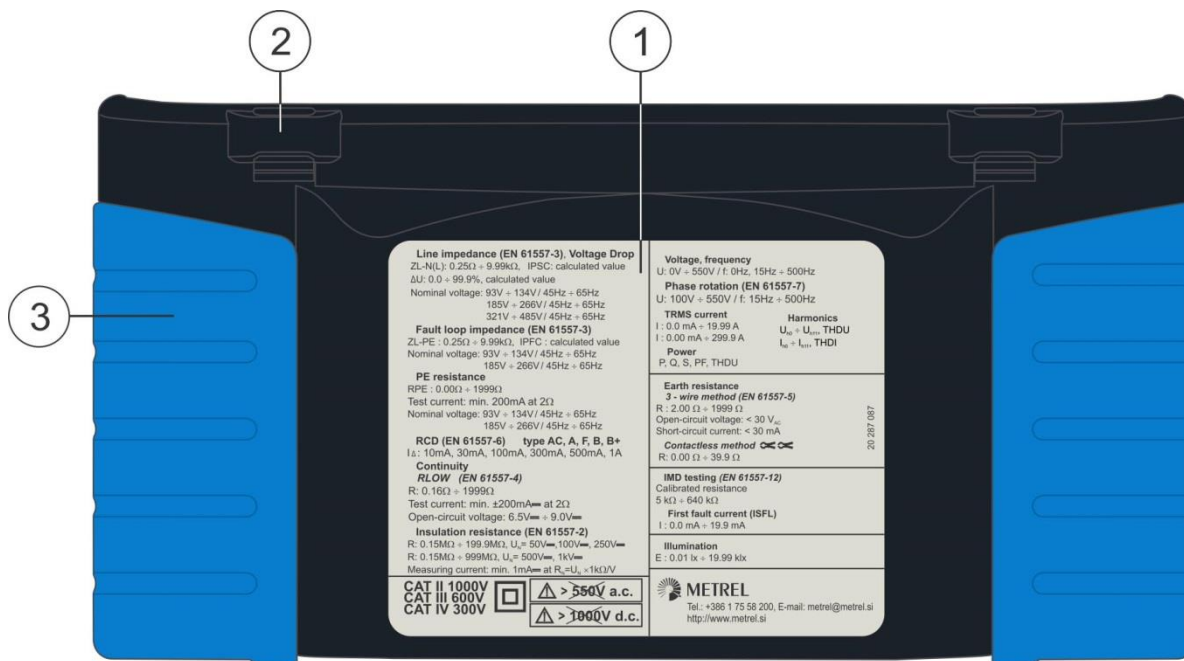

Figure 3.5: Bottom view

1	<b>Bottom information label</b>
2	<b>Neck belt openings</b>
3	<b>Handling side covers</b>

### 3.4 Carrying the instrument

With the neck-carrying belt supplied in standard set, various possibilities of carrying the instrument are available. Operator can choose appropriate one on basis of his operation, see the following examples:



The instrument hangs around operator's neck only – quick placing and displacing.



The instrument can be used even when placed in soft carrying bag – test cable connected to the instrument through the front aperture.

#### 3.4.1 Secure attachment of the strap

You can choose between two methods:

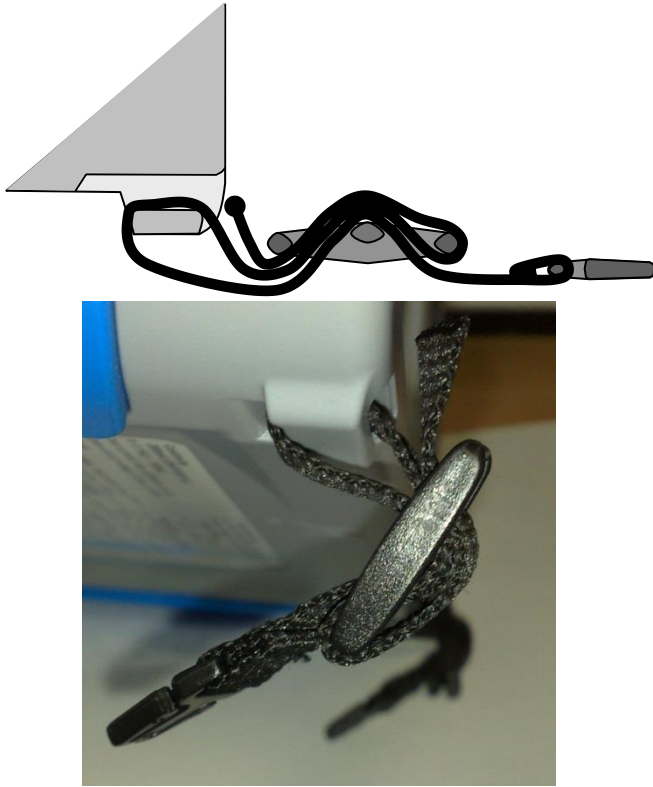

Figure 3.6: First method

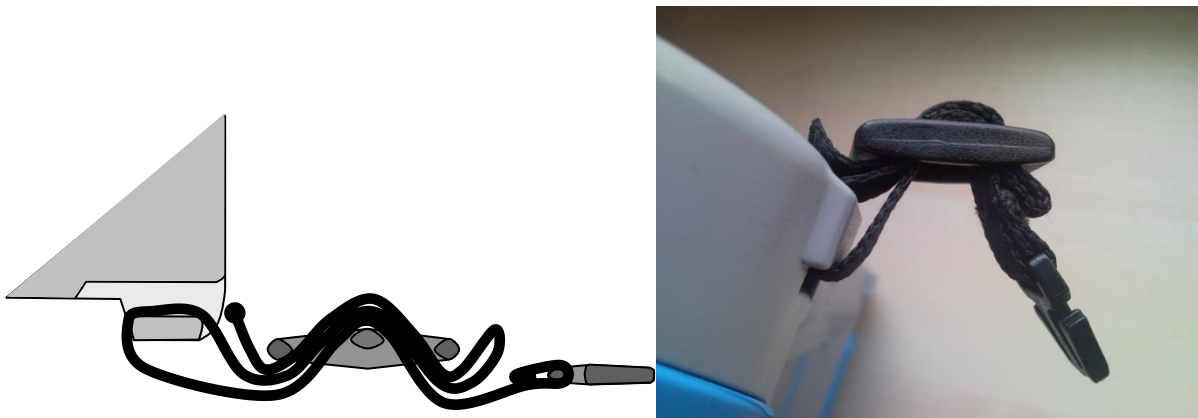

Figure 3.7: Alternative method

Please perform a periodical check of the attachment.

## 4 Instrument operation

The EurotestXC instrument can be manipulated via a keypad or touch screen.

### 4.1 General meaning of keys

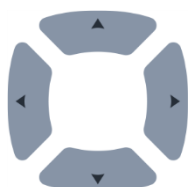

Cursor keys are used to:

- › select appropriate option.



Run key is used to:

- › confirm selected option;
- › start and stop measurements;
- › test PE potential.



Escape key is used to:

- › return to previous menu without changes;
- › abort measurements.



Option key is used to:

- › expand column in control panel.



Save key is used to:

- › store test results.



Single Tests key is used as:

- › shortcut key to enter Single Tests menu.



Auto Tests key is used as:

- › shortcut key to enter Auto Tests menu.



Memory Organizer key is used as:

- › shortcut key to enter Memory Organizer menu.



Backlight key is used to:

- › toggle screen brightness between High and Low intensity.



General Settings key is used to:

- › enter General Settings menu.



On / Off key is used to:

- › switch On / Off the instrument;
- › switch Off the instrument if pressed and held for 5 s.

## 4.2 General meaning of touch gestures

---



Tap (briefly touch surface with fingertip) is used to:

- › select appropriate option;
  - › confirm selected option;
  - › start and stop measurements.
- 



Swipe (press, move, lift) up / down is used to:

- › scroll content in same level;
  - › navigate between views in same level.
- 



**long**

Long press (touch surface with fingertip for at least 1 s) is used to:

- › select additional keys (virtual keyboard);
  - › enter cross selector from single test screens.
- 











Tap Escape icon is used to:

- › return to previous menu without changes;
  - › abort measurements.
-

## 4.3 Virtual keyboard



Figure 4.1: Virtual keyboard

	Toggle case between lowercase and uppercase. Active only when alphabetic characters keyboard layout selected.
	Backspace Clears last character or all characters if selected. (If held for 2 s, all characters are selected).
	Enter confirms new text.
	Activates numeric / symbols layout.
	Activates alphabetic characters.
	English keyboard layout.
	Greek keyboard layout.
	Returns to the previous menu without changes.



## 4.4 Display and sound

### 4.4.1 Terminal voltage monitor

The terminal voltage monitor displays on-line the voltages on the test terminals and information about active test terminals in the a.c. installation measuring mode.

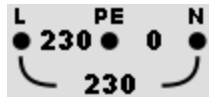

Online voltages are displayed together with test terminal indication. All three test terminals are used for selected measurement.

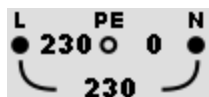

Online voltages are displayed together with test terminal indication.  
L and N test terminals are used for selected measurement.

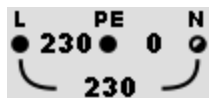

L and PE are active test terminals.  
N terminal should also be connected for correct input voltage condition.

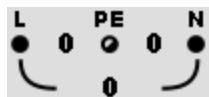

L and N are active test terminals.  
PE terminal should also be connected for correct input voltage condition.

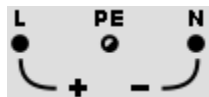

Polarity of test voltage applied to the output terminals, L and N.

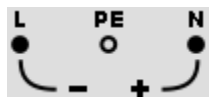

L and PE are active test terminals.

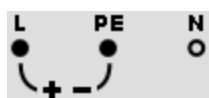

Polarity of test voltage applied to the output terminals, L and PE.

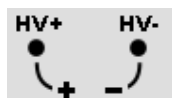
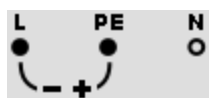

2.5 kV Insulation measurement terminal screen. (MI 3152H only)

## 4.4.2 Battery indication

The battery indication indicates the charge condition of battery and connection of external charger.



Battery capacity indication.

Battery is in good condition.



Battery is full.



Low battery.

Battery is too weak to guarantee correct result. Replace or recharge the battery cells.



Empty battery or no battery.



Charging in progress (if power supply adapter is connected).

## 4.4.3 Measurement actions and messages



Conditions on the input terminals allow starting the measurement. Consider other displayed warnings and messages.



Conditions on the input terminals do not allow starting the measurement. Consider displayed warnings and messages.



Proceeds to next step of the measurement.



Stop the measurement.



Result(s) can be stored.



Starts test leads compensation in Rlow / continuity measurement.

Starts Zref line impedance measurement at origin of electrical installation in Voltage Drop measurement. Zref value is set to 0.00  $\Omega$  if pressing this touch key while instrument is not connected to a voltage source.



Use A 1199 Specific earth resistance adapter for this test.



Use A 1143 Euro Z 290 A adapter for this test.



Use A 1172 or A 1173 Illumination sensor for this test.



Count down timer (in seconds) within measurement.



Measurement is running, consider displayed warnings.



RCD tripped-out during the measurement (in RCD functions).



Instrument is overheated. The measurement is prohibited until the temperature decreases under the allowed limit.



High electrical noise was detected during measurement. Results may be impaired.

Indication of noise voltage above 5 V between H and E terminals during earth resistance measurement.



L and N are changed.

In most instrument profiles L and N test terminals are reversed automatically according to detected voltages on input terminal. In instrument profiles for countries where the position of phase and neutral connector is defined the selected feature is not working.



**Warning!** High voltage is applied to the test terminals.

The instrument automatically discharge tested object after finished insulation measurement.

When an insulation resistance measurement has been performed on a capacitive object, automatic discharge may not be done immediately! The warning symbol and the actual voltage are displayed during discharge until voltage drops below 30 V.



**Warning!** Dangerous voltage on the PE terminal! Stop the activity immediately and eliminate the fault / connection problem before proceeding with any activity!

Continuous sound warning is also present.



Test leads resistance in R low / Continuity measurement is not compensated.



Test leads resistance in R low / Continuity measurement is compensated.



High resistance to earth of current test probes. Results may be impaired.



High resistance to earth of potential test probes. Results may be impaired.



High resistance to earth of potential and current test probes. Results may be impaired.



Too small current for declared accuracy. Results may be impaired. Check in Current Clamp Settings if sensitivity of current clamp can be increased. In Earth 2 Clamp measurement results are very accurate for resistances below 10  $\Omega$ . At higher values (several 10  $\Omega$ ) the test current drops to few mA. The measuring accuracy for small currents and immunity against noise currents must be considered!



Measured signal is out of range (clipped). Results are impaired.



Single fault condition in IT system. (MI 3152 only)



Fuse F1 is broken.

#### 4.4.4 Result indication



Measurement result is inside pre-set limits (PASS).

---



Measurement result is out of pre-set limits (FAIL).

---



Measurement is aborted. Consider displayed warnings and messages.

RCD t and RCD I measurements will only be performed if the contact voltage in the pre-test at nominal differential current is lower than the set contact voltage limit!

---

## 4.5 Instruments main menu

From the **Main menu** different main operation menus can be selected.

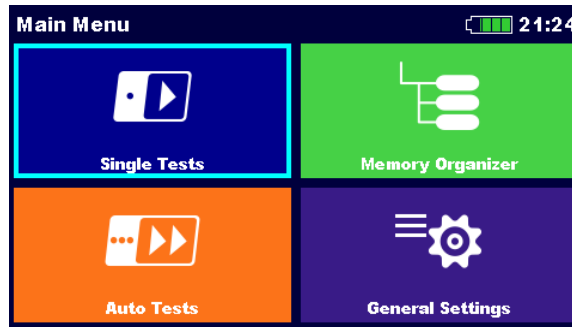

Figure 4.2: Main menu

### Options



#### Single Tests

Menu with single tests, see chapter **6 Single tests**.



#### Auto Tests

Menu with customized test sequences, see chapter **8 Auto tests**.



#### Memory Organizer

Menu for working with and documentation of test data, see chapter **5 Memory Organizer**.



#### General Settings

Menu for setup of the instrument, see chapter **4.6 General Settings**.

## 4.6 General Settings

In the **General settings menu** general parameters and settings of the instrument can be viewed or set.

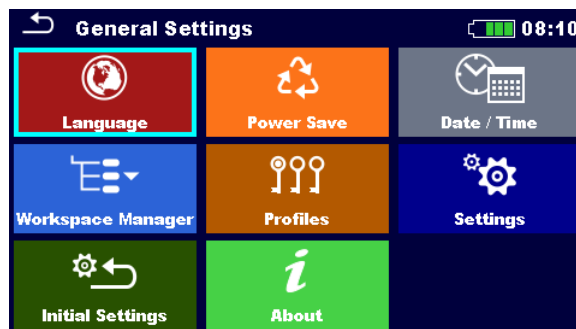









Figure 4.3: General settings menu

### Options

	<b>Language</b> Instrument language selection.
	<b>Power Save</b> Brightness of LCD, enabling/disabling Bluetooth communication.
	<b>Date /Time</b> Instruments Date and time.
	<b>Workspace Manager</b> Manipulation with project files. Refer to chapter <b>4.8 Workspace Manager menu</b> for more information.
	<b>Instrument Profile</b> Selection of available instrument profiles. Refer to chapter <b>4.7 Instrument profiles</b> .
	<b>Settings</b> Settings of different system / measuring parameters.
	<b>Initial Settings</b> Factory settings.
	<b>About</b> Instrument info.

### 4.6.1 Language

In this menu the language of the instrument can be set.

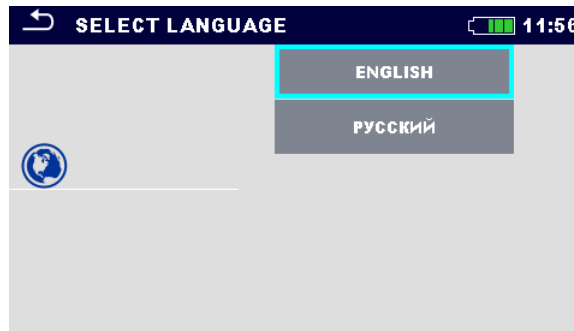

Figure 4.4: Language menu

### 4.6.2 Power Save

In this menu different options for decreasing power consumption can be set.

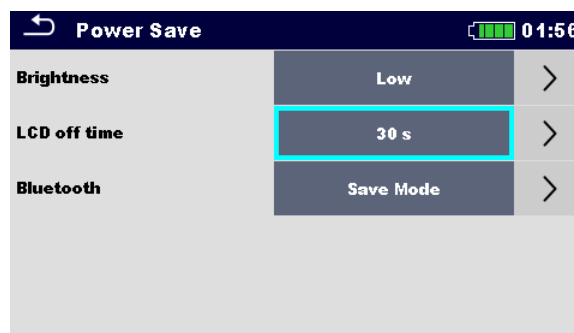

Figure 4.5: Power save menu

<b>Brightness</b>	Setting level of LCD brightness level. Power saving at low level: ca 15%
<b>LCD off time</b>	Setting LCD off after set time interval. LCD is switched on after pressing any key or touching the LCD. Power saving at LCD off (at low level brightness): ca 20%
<b>Bluetooth</b>	Always On: Bluetooth module is ready to communicate. Save mode: Bluetooth module is set to sleep mode and is not functioning. Power saving in Save mode: 7 %

### 4.6.3 Date and time

In this menu date and time of the instrument can be set.

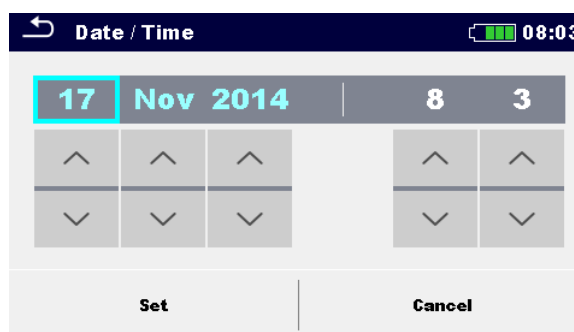

Figure 4.6: Setting date and time

**Note:**

- If the batteries are removed the set date and time will be lost.

## 4.6.4 Settings

In this menu different general parameters can be set.

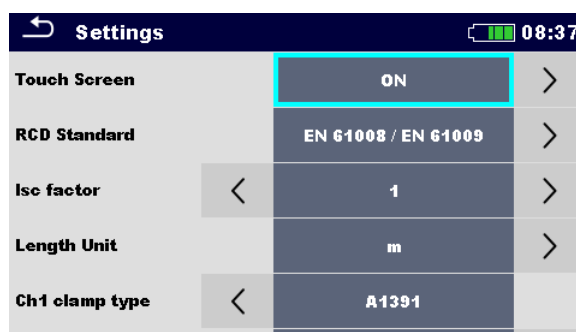

Figure 4.7: Settings menu

	Available selection	Description
<b>Touch screen</b>	[ON, OFF]	Enables / disables operation with touch screen.
<b>RCD Standard</b>	[EN 61008 / EN 61009, IEC 60364-4-41 TN/IT, IEC 60364-4-41 TT, BS 7671, AS/NZS 3017]	Used standard for RCD tests. Refer to the end of this chapter for more information. Maximum RCD disconnection times differ in various standards. The trip-out times defined in individual standards are listed below.
<b>Isc factor</b>	[0.20 ... 3.00] Default value: 1.00	Short circuit current Isc in the supply system is important for selection or verification of protective circuit breakers (fuses, over-current breaking devices, RCDs). The value should be set according to local regulative.
<b>Length Unit</b>	[m, ft]	Length unit for specific earth resistance measurement.
<b>Ch1 clamp type</b>	[A 1018, A 1019, A1391]	Model of current clamp adaptor.
<b>Range</b>	A 1018: [20 A] A1019: [20 A] A 1391: [40 A, 300 A]	Measuring range of selected current clamp adaptor. Measuring range of the instrument must be considered. Measurement range of current clamp adaptor can be higher than of the instrument.
<b>Merge fuses</b>	[yes, no]	[Yes]: fuse type and parameters set in one function are also kept for other functions! [No]: Fuse parameters will be considered only in function where they have been set.
<b>Commander</b>	[enabled, disabled]	The disabled option is intended to disable the commander's remote keys. In case of high EM interfering noise the operation of the commander can be irregular.
<b>Earthing system</b>	[TN/TT, IT (MI 3152 only)]	Terminal voltage monitor and measuring functions are suited to selected earthing



system.

#### 4.6.4.1 RCD standard

Maximum RCD disconnection times differ in various standards. The trip-out times defined in individual standards are listed below.

	$\frac{1}{2} \times I_{\Delta N}^{1)}$	$I_{\Delta N}$	$2 \times I_{\Delta N}$	$5 \times I_{\Delta N}$
<b>General RCDs (non-delayed)</b>	$t_{\Delta} > 300$ ms	$t_{\Delta} < 300$ ms	$t_{\Delta} < 150$ ms	$t_{\Delta} < 40$ ms
<b>Selective RCDs (time-delayed)</b>	$t_{\Delta} > 500$ ms	$130 \text{ ms} < t_{\Delta} < 500$ ms	$60 \text{ ms} < t_{\Delta} < 200$ ms	$50 \text{ ms} < t_{\Delta} < 150$ ms

Table 4.1: Trip-out times according to EN 61008 / EN 61009

Test according to standard IEC/HD 60364-4-41 has two selectable options:

- IEC 60364-4-41 TN/IT and
- IEC 60364-4-41 TT

The options differ to maximum disconnection times as defined in IEC/HD 60364-4-41 Table 41.1.

	$U_0^{3)}$	$\frac{1}{2} \times I_{\Delta N}^{1)}$	$I_{\Delta N}$	$2 \times I_{\Delta N}$	$5 \times I_{\Delta N}$
<b>TN / IT</b>	$\leq 120$ V	$t_{\Delta} > 800$ ms	$t_{\Delta} \leq 800$ ms	$t_{\Delta} < 150$ ms	$t_{\Delta} < 40$ ms
	$\leq 230$ V	$t_{\Delta} > 400$ ms	$t_{\Delta} \leq 400$ ms		
<b>TT</b>	$\leq 120$ V	$t_{\Delta} > 300$ ms	$t_{\Delta} \leq 300$ ms		
	$\leq 230$ V	$t_{\Delta} > 200$ ms	$t_{\Delta} \leq 200$ ms		

Table 4.2: Trip-out times according to IEC/HD 60364-4-41

	$\frac{1}{2} \times I_{\Delta N}^{1)}$	$I_{\Delta N}$	$2 \times I_{\Delta N}$	$5 \times I_{\Delta N}$
<b>General RCDs (non-delayed)</b>	$t_{\Delta} > 1999$ ms	$t_{\Delta} < 300$ ms	$t_{\Delta} < 150$ ms	$t_{\Delta} < 40$ ms
<b>Selective RCDs (time-delayed)</b>	$t_{\Delta} > 1999$ ms	$130 \text{ ms} < t_{\Delta} < 500$ ms	$60 \text{ ms} < t_{\Delta} < 200$ ms	$50 \text{ ms} < t_{\Delta} < 150$ ms

Table 4.3: Trip-out times according to BS 7671

RCD type	$I_{\Delta N}$ (mA)	$\frac{1}{2} \times I_{\Delta N}^{1)}$ $t_{\Delta}$	$I_{\Delta N}$ $t_{\Delta}$	$2 \times I_{\Delta N}$ $t_{\Delta}$	$5 \times I_{\Delta N}$ $t_{\Delta}$	Note
<b>I</b>	$\leq 10$	$> 999$ ms	40 ms	40 ms	40 ms	Maximum break time
<b>II</b>	$> 10 \leq 30$		300 ms	150 ms	40 ms	
<b>III</b>	$> 30$		300 ms	150 ms	40 ms	
<b>IV S</b>	$> 30$		$> 999$ ms	500 ms 130 ms	200 ms 60 ms	150 ms 50 ms

Table 4.4: Trip-out times according to AS/NZS 3017<sup>2)</sup>

Standard	$\frac{1}{2} \times I_{\Delta N}$	$I_{\Delta N}$	$2 \times I_{\Delta N}$	$5 \times I_{\Delta N}$
<b>EN 61008 / EN 61009</b>	300 ms	300 ms	150 ms	40 ms
<b>IEC 60364-4-41</b>	1000 ms	1000 ms	150 ms	40 ms
<b>BS 7671</b>	2000 ms	300 ms	150 ms	40 ms
<b>AS/NZS 3017 (I, II, III)</b>	1000 ms	1000 ms	150 ms	40 ms

Table 4.5: Maximum test times related to selected test current for general (non-delayed) RCD

Standard	$\frac{1}{2} \times I_{\Delta N}$	$I_{\Delta N}$	$2 \times I_{\Delta N}$	$5 \times I_{\Delta N}$
EN 61008 / EN 61009	500 ms	500 ms	200 ms	150 ms
IEC 60364-4-41	1000 ms	1000 ms	150 ms	40 ms
BS 7671	2000 ms	500 ms	200 ms	150 ms
AS/NZS 3017 (IV)	1000 ms	1000 ms	200 ms	150 ms

Table 4.6: Maximum test times related to selected test current for selective (time-delayed) RCD

- <sup>1)</sup> Minimum test period for current of  $\frac{1}{2} \times I_{\Delta N}$ , RCD shall not trip-out.  
<sup>2)</sup> Test current and measurement accuracy correspond to AS/NZS 3017 requirements.  
<sup>3)</sup>  $U_0$  is nominal  $U_{LPE}$  voltage.

**Note:**

- › Trip-out limit times for PRCD, PRCD-K and PRCD-S are equal to General (non-delayed) RCDs.

## 4.6.5 Initial Settings

In this menu the instrument settings, measurement parameters and limits can be set to initial (factory) values.

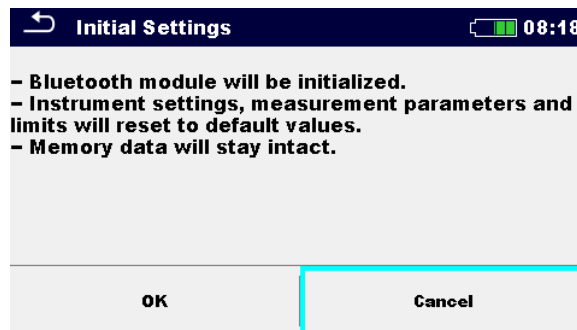

Figure 4.8: Initial settings menu

**Warning:**

Following customized settings will be lost when setting the instruments to initial settings:

- › Measurement limits and parameters,
- › Parameters and settings in General settings menu.
- › If the batteries are removed the custom made settings will be lost.

**Note:**

Following customized settings will stay:

- › Profile settings,
- › Data in memory.

## 4.6.6 About

In this menu instrument data (name, serial number, version, fuse version and date of calibration) can be viewed.

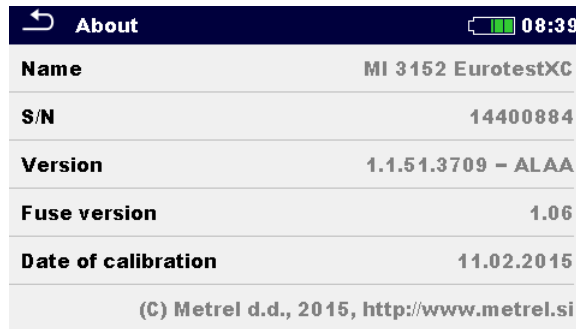

About	
Name	MI 3152 EurotestXC
S/N	14400884
Version	1.1.51.3709 - ALAA
Fuse version	1.06
Date of calibration	11.02.2015
(C) Metrel d.d., 2015, <a href="http://www.metrel.si">http://www.metrel.si</a>	

Figure 4.9: Instrument info screen

## 4.7 Instrument profiles

In this menu the instrument profile can be selected from the available ones.

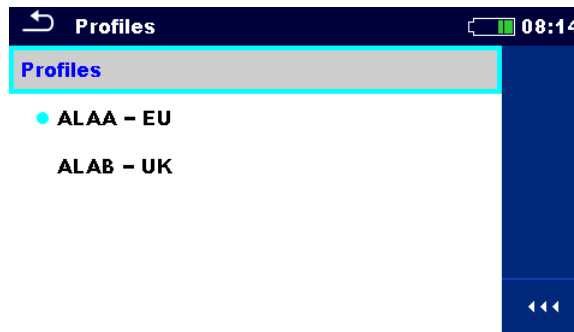

Figure 4.10: Instrument profiles menu

The instrument uses different specific system and measuring settings in regard to the scope of work or country it is used. These specific settings are stored in instrument profiles.

By default each instrument has at least one profile activated. Proper licence keys must be obtained to add more profiles to the instruments.

If different profiles are available they can be selected in this menu.

### Options



Loads the selected profile. The instrument will restart automatically with new profile loaded.



Deletes the selected profile.

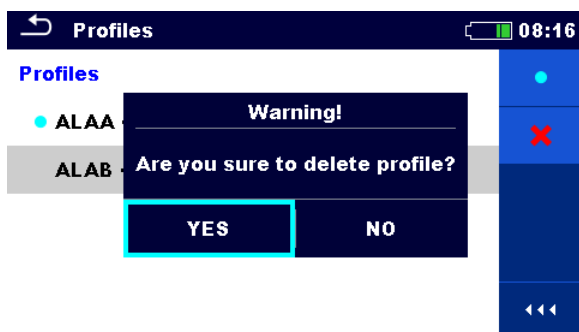

Before deleting the selected profile user is asked for confirmation.



Opens more options in control panel / expands column.

## 4.8 Workspace Manager menu

The Workspace Manager is intended to manage with different Workspaces and Exports that are stored into internal data memory.

### 4.8.1 Workspaces and Exports

The works with MI 3152(H) EurotestXC can be organized and structured with help of Workspaces and Exports. Exports and Workspaces contain all relevant data (measurements, parameters, limits, structure objects) of an individual work.

Workspaces are stored on internal data memory on directory WORKSPACES, while Exports are stored on directory EXPORTS. Export files can be read by Metrel applications that run on other devices. Exports are suitable for making backups of important works. To work on the instrument an Export should be imported first from the list of Exports and converted to a Workspace. To be stored as Export data a Workspace should be exported first from the list of Workspaces and converted to an Export.

### 4.8.2 Workspace Manager main menu

In Workspace manager Workspaces and Exports are displayed in two separated lists.

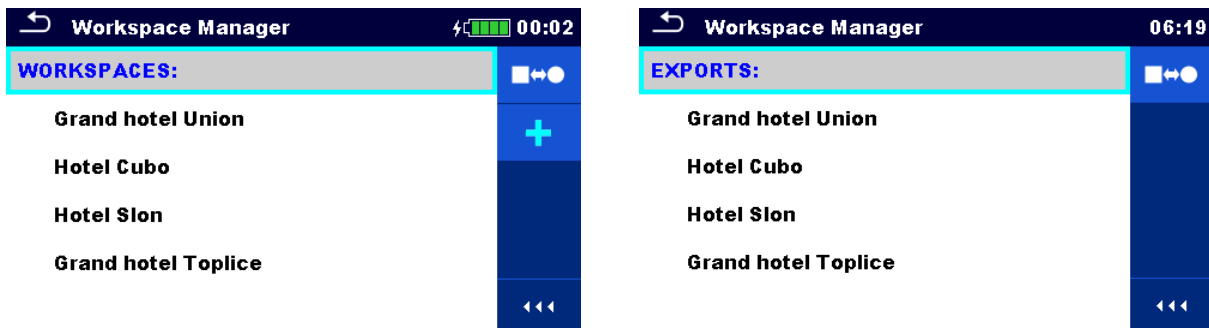

Figure 4.11: Workspace manager menu

#### Options

	List of Workspaces.
	Displays a list of Exports.
	Adds a new Workspace. Refer to chapter <b>4.8.5 Adding a new Workspace</b> for more information.
	List of Exports.
	Displays a list of Workspaces.
	Opens more options in control panel / expands column.

### 4.8.3 Operations with Workspaces

Only one Workspace can be opened in the instrument at the same time. The Workspace selected in the Workspace Manager will be opened in the Memory Organizer.

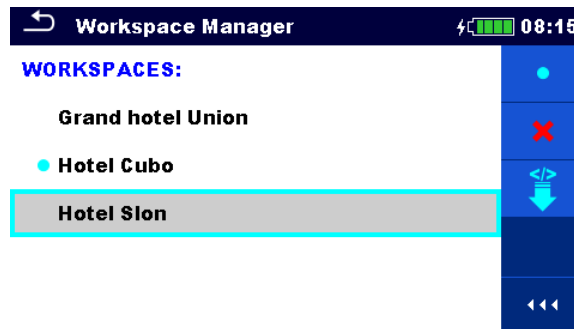

Figure 4.12: Workspaces menu

#### Options



Marks the opened Workspace in Memory Organizer.  
Opens the selected Workspace in Memory Organizer.  
Refer to chapter **4.8.6 Opening a Workspace** for more information.



Deletes the selected Workspace.  
Refer to chapter **4.8.7 Deleting a Workspace / Export** for more information.



Adds a new Workspace.  
Refer to chapter **4.8.5 Adding a new Workspace** for more information.



Exports a Workspace to an Export.  
Refer to **4.8.9 Exporting a Workspace** for more information.



Opens more options in control panel / expands column.

### 4.8.4 Operations with Exports

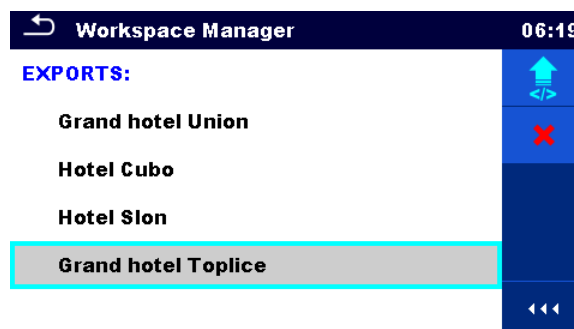

Figure 4.13: Workspace manager Exports menu

#### Options



Deletes the selected Export.

Refer to chapter **4.8.7 Deleting a Workspace / Export** for more information.

---



Imports a new Workspace from Export.

Refer to **4.8.8 Importing a Workspace** for more information.

---



Opens more options in control panel / expands column.

---

## 4.8.5 Adding a new Workspace

### Procedure

- ①  New Workspaces can be added from the Workspace Manager screen.

- ②  Enters option for adding a new Workspace.

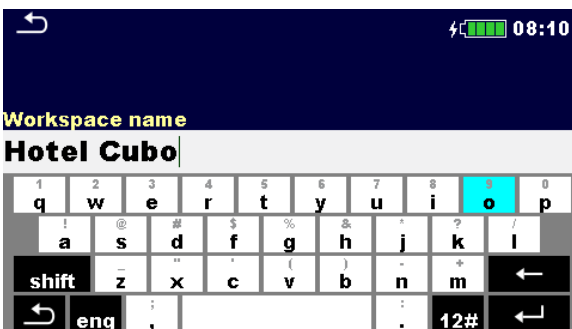
 Keypad for entering name of a new Workspace is displayed after selecting New.

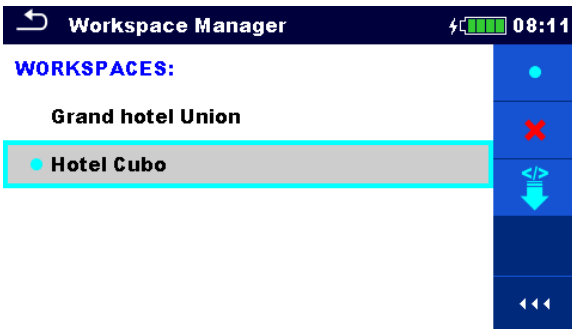
- ③  After confirmation a new Workspace is added in the list in Main Workspace Manager menu.



## 4.8.6 Opening a Workspace

### Procedure

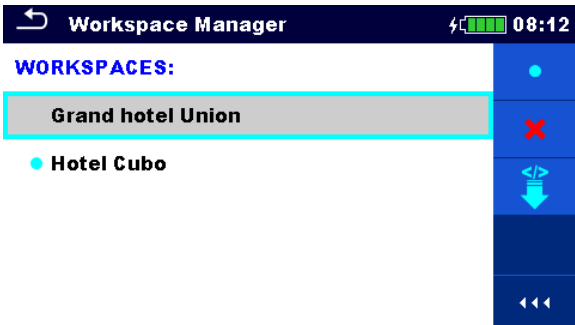
①  Workspace can be selected from a list in Workspace manager screen.

②  Opens a Workspace in Workspace manager.

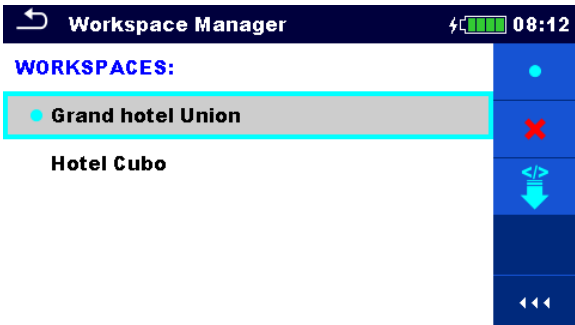
 The opened Workspace is marked with a blue dot. The previously opened Workspace will close automatically.

## 4.8.7 Deleting a Workspace / Export

### Procedure

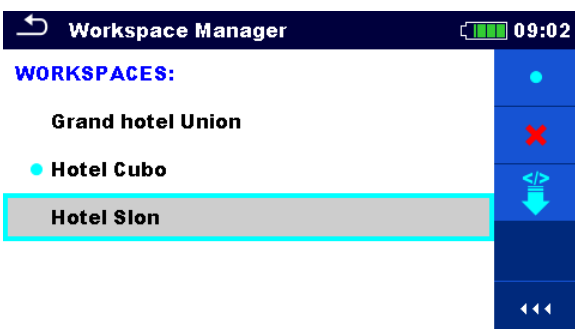
①  Workspace / Export to be deleted should be selected from the list of Workspaces / Exports.

Opened workspace can't be deleted.

②  Enters option for deleting a Workspace / Export.

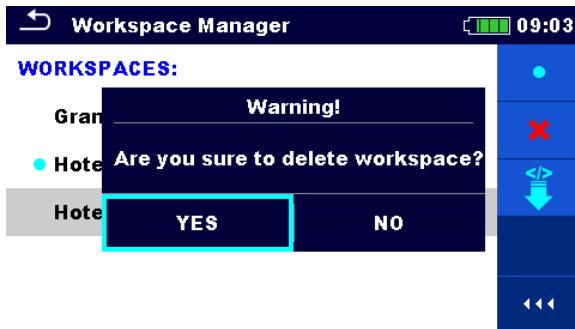

Before deleting the selected Workspace / Export the user is asked for confirmation.



Workspace / Export is removed from the Workspace / Export list.

### 4.8.8 Importing a Workspace



Select an Export file to be imported from Workspace manager Export list.



Enters option Import.

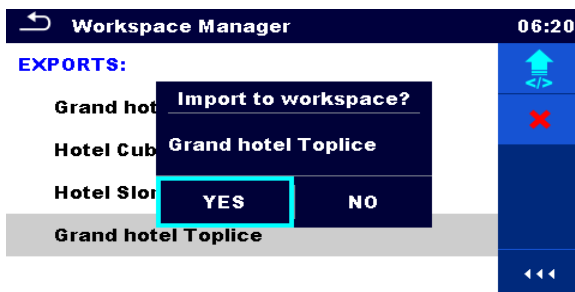

Before the import of the selected Export file the user is asked for confirmation.



The imported Export file is added to the list of Workspaces.

**Note:**

If a Workspace with the same name already exists the name of the imported Workspace will be changed (name\_001, name\_002, name\_003, ...).

### 4.8.9 Exporting a Workspace



Select a Workspace from Workspace manager list to be exported to an Export file.



Enters option Export.

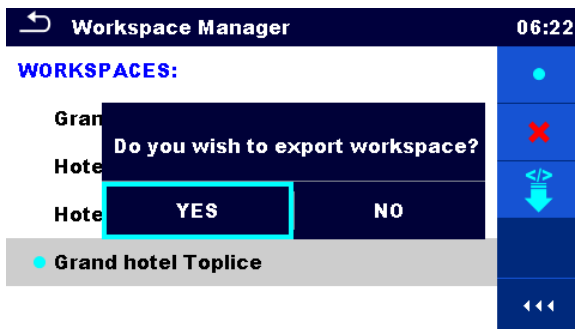

Before exporting the selected Workspace the user is asked for confirmation.

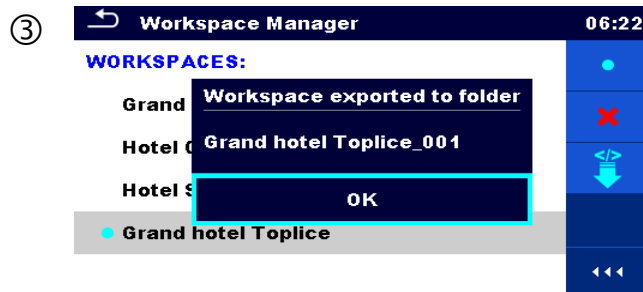

Workspace is exported to Export file and is added to the list of Exports.

**Note:**  
If an Export file with the same name already exists the name of the Export file will be changed (name\_001, name\_002, name\_003, ...).



## 5 Memory Organizer

Memory Organizer is a tool for storing and working with test data.

### 5.1 Memory Organizer menu

The data is organized in a tree structure with Structure objects and Measurements. EurotestXC instrument has a multi-level structure. The hierarchy of Structure objects in the tree is shown on **Figure 5.1**.

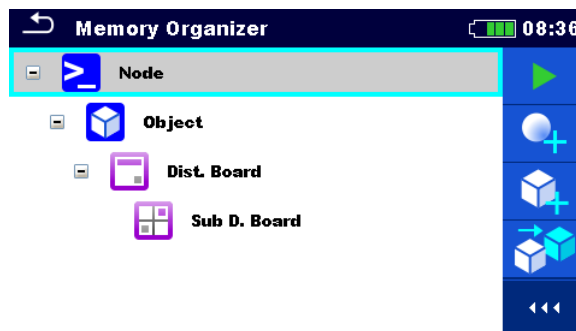

Figure 5.1: Default tree structure and its hierarchy

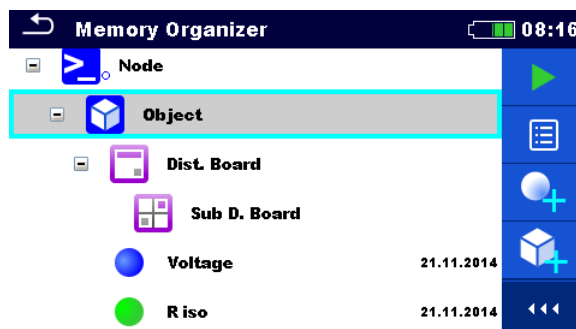

Figure 5.2: Example of a tree menu

#### 5.1.1 Measurement statuses

Each measurement has:

- › a status (Pass or Fail or no status),
- › a name,
- › results,
- › limits and parameters.

A measurement can be a Single test or an Auto test. For more information refer to chapters **7 Tests and measurements** and **8 Auto tests**.

#### Statuses of Single tests

---

● passed finished single test with test results

● failed finished single test with test results

---

- finished single test with test results and no status
- empty single test without test results

### Overall statuses of Auto tests

- at least one single test in the Auto test passed and no single test failed
- at least one single test in the Auto test failed
- at least one single test in the Auto test was carried out and there were no other passed or failed single tests.
- empty Auto test with empty single tests

## 5.1.2 Structure Objects

Each Structure object has:

- › an icon
- › a name and
- › parameters.

Optionally they can have:

- › an indication of the status of the measurements under the Structure object and
- › a comment or a file attached.



Figure 5.3: Structure object in tree menu

### 5.1.2.1 Measurement status indication under the Structure object

Overall status of measurements under each structure element /sub-element can be seen without spreading tree menu. This feature is useful for quick evaluation of test status and as guidance for measurements.

#### Options

 **Object** There are no measurement results under selected structure object. Measurements should be made.

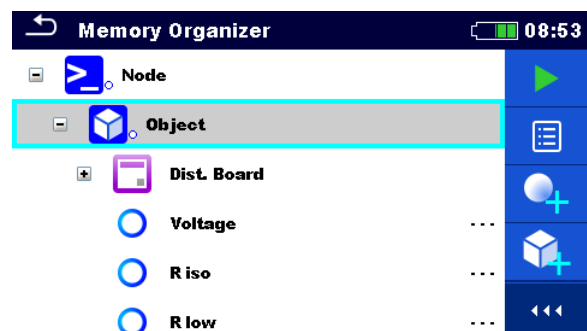

 **Object** One or more measurement result(s) under selected structure object has failed. Not all measurements under selected structure object have been made yet.

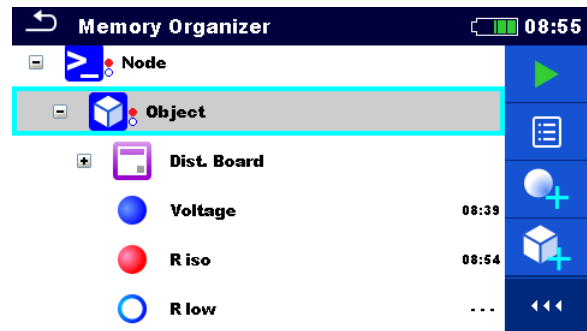

 **Object** All measurements under selected structure object are completed but one or more measurement result(s) has failed.

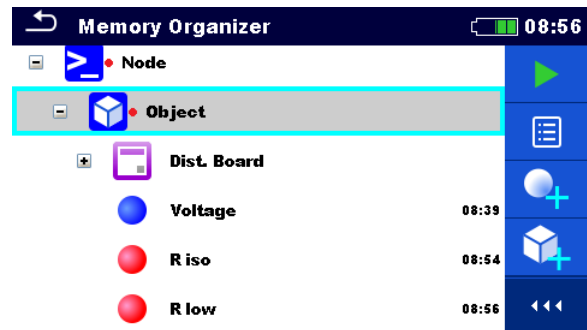

**Note:**

- There is no status indication if all measurement results under each structure element /sub-element have passed or if there is an empty structure element / sub-element (without measurements).

### 5.1.3 Operations in Tree menu

In the Memory organizer different actions can be taken with help of the control panel at the right side of the display. Possible actions depend on the selected element in the organizer.

#### 5.1.3.1 Operations on measurements (finished or empty measurements)

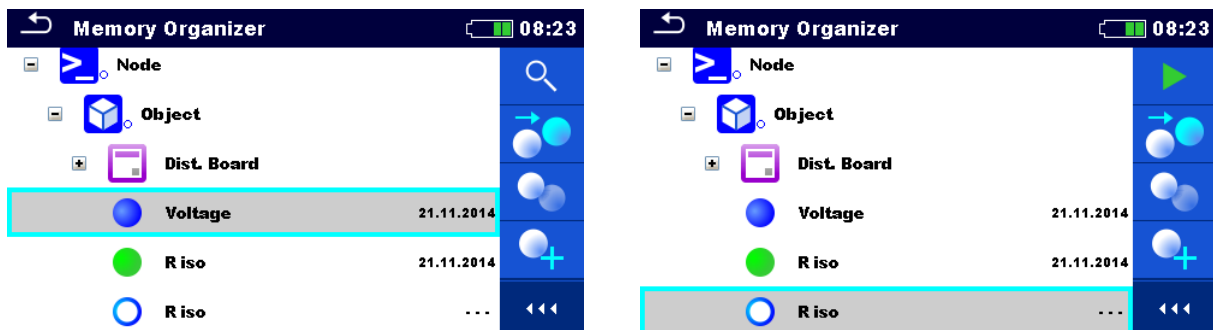

Figure 5.4: A measurement is selected in the Tree menu

### Options



Views results of measurement.

The instrument goes to the measurement memory screen. Refer to chapter **6.1.8**

**Recall single test results screen.**

Starts a new measurement.

The instrument goes to the measurement start screen. Refer to chapter **6.1.3 Single test start screen** for more information.



Clones the measurement.

The selected measurement can be copied as an empty measurement under the same Structure object. Refer to chapter **5.1.3.7 Clone a measurement** for more information.



Copies & Paste a measurement.

The selected measurement can be copied and pasted as an empty measurement to any location in structure tree. Multiple "Paste" is allowed. Refer to chapter **5.1.3.10 Copy & Paste a measurement** for more information.



Adds a new measurement.

The instrument goes to the Menu for adding measurements. Refer to chapter **5.1.3.5 Add a new measurement** for more information.



Deletes a measurement.

Selected Measurement can be deleted. User is asked for confirmation before the deleting. Refer to chapter **5.1.3.12 Delete a measurement** for more information.

**5.1.3.2 Operations on Structure objects**

The structure object must be selected first.

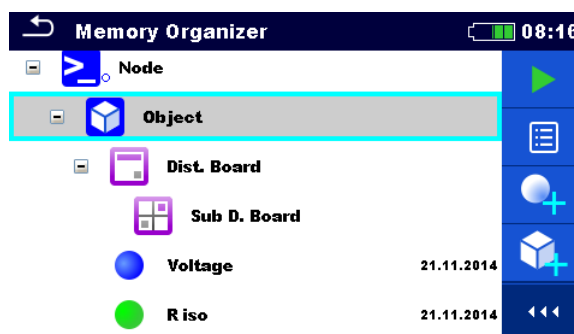

Figure 5.5: A structure object is selected in the Tree menu

**Options**

Starts a new measurement.

Type of measurement (Single test or Auto test) should be selected first. After proper type is selected, the instrument goes to Single Test or Auto Test selection screen. Refer to chapters **6.1 Selection modes**.



Saves a measurement.

Saving of measurement under the selected Structure object.



View / edit parameters and attachments.

---

Parameters and attachments of the Structure object can be viewed or edited.

Refer to chapter **5.1.3.3 View / Edit parameters and attachments of a Structure object** for more information.

---



Adds a new measurement.

The instrument goes to the Menu for adding measurement into structure. Refer to chapter **5.1.3.5 Add a new measurement** for more information.

---



Adds a new Structure object.

A new Structure object can be added. Refer to chapter **5.1.3.4 Add a new Structure Object** for more information.

---



Attachments.

Name and link of attachment is displayed.

---



Clones a Structure object.

Selected Structure object can be copied to same level in structure tree (clone). Refer to chapter **5.1.3.6 Clone a Structure object** for more information.

---



Copies & Paste a Structure object.

Selected Structure object can be copied and pasted to any allowed location in structure tree. Multiple "Paste" is allowed. Refer to chapter **5.1.3.8 Copy & Paste a Structure object** for more information.

---



Deletes a Structure object.

Selected Structure object and sub-elements can be deleted. User is asked for confirmation before the deleting. Refer to chapter **5.1.3.11 Delete a Structure object** for more information.

---



Renames a Structure object.

Selected Structure object can be renamed via keypad. Refer to chapter **5.1.3.13 Rename a Structure object** for more information.

---



Expands column in control panel.

---



### 5.1.3.3 View / Edit parameters and attachments of a Structure object

The parameters and their content are displayed in this menu. To edit the selected parameter, tap on it or press the  key to enter menu for editing parameters.

#### Procedure

①  Select structure object to be edited.

②  Select Parameters in Control panel.

③  Example of Parameters menu.

None	
Name (designation) of object	Object
Description (of object)	
Location (of object)	
Data	

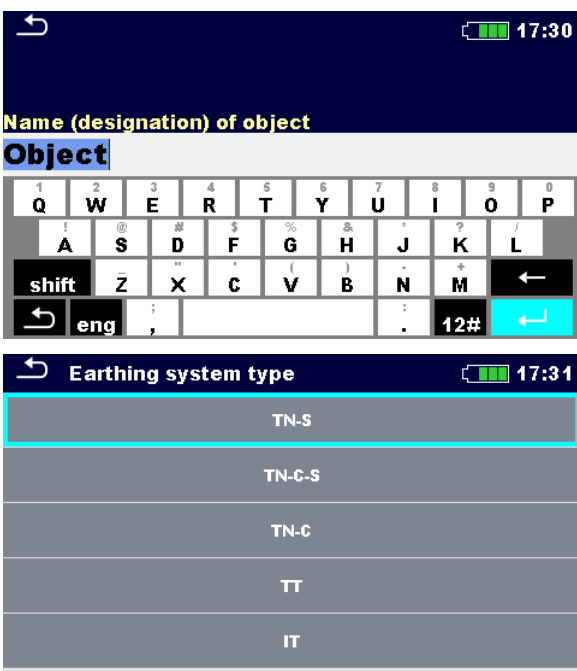
④  In menu for editing parameters the parameter's value can be selected from a dropdown list or entered via keypad. Refer to chapter **4 Instrument operation** for more information about keypad operation.

②a  Select Attachments in Control panel.

③ a





Attachments

The name of attachment can be seen.  
Operation with attachments is not supported in the instrument.

### 5.1.3.4 Add a new Structure Object

This menu is intended to add new structure objects in the tree menu. A new structure object can be selected and then added in the tree menu.

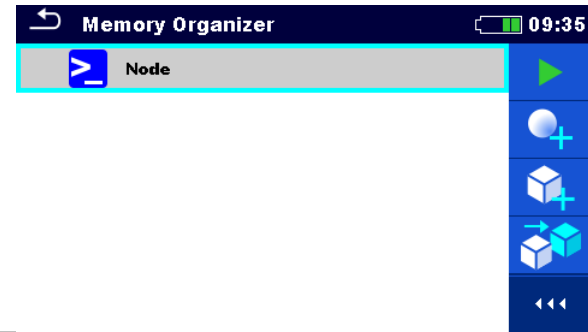
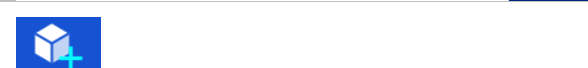
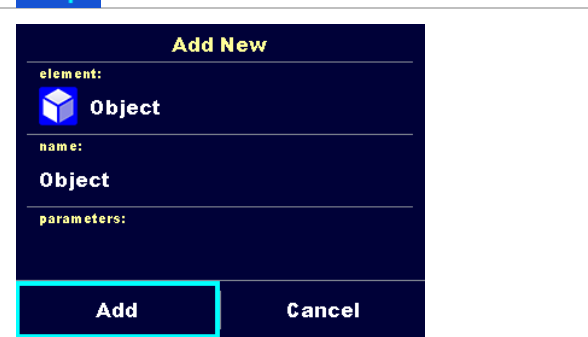
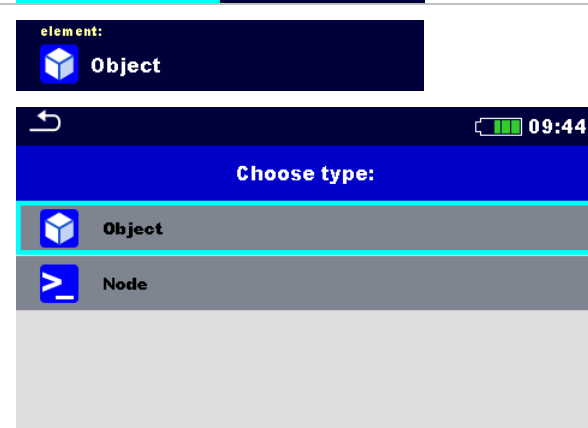
#### Procedure

- |    |   |   |
|----|---|---|
| ①  |    | Default initial structure.  |
| ②  |    | Select Add Structure in Control panel.  |
| ③  |   | Add a new structure object menu.  |
| ③a |  | <p>The type of structure object to be added can be selected first from dropdown menu.</p> <p>Only structure objects that can be used in the same level or next sub-level are offered.</p> |
| ③b |  | The name of structure object can be edited.   |



③c



Parameters of the Structure object can be edited.

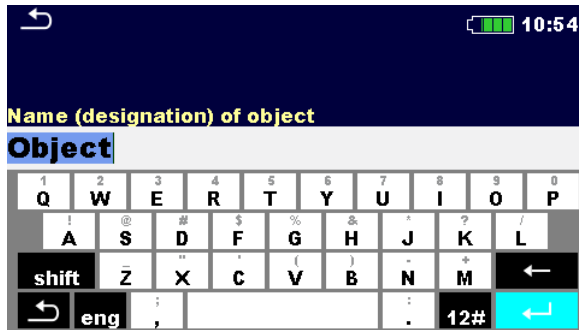
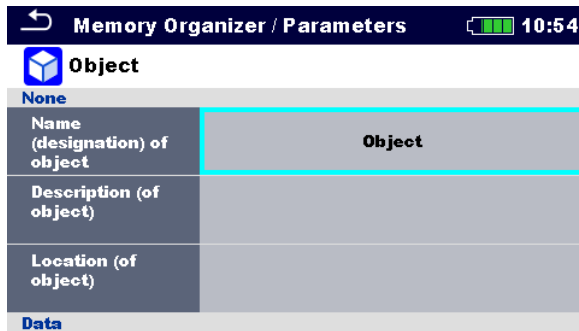

④



Adds the selected structure object in the tree menu.



Returns to the tree menu without changes.

⑤

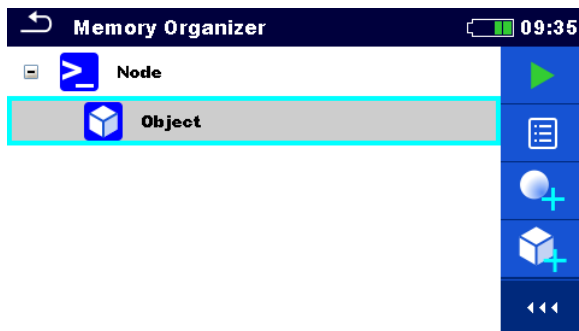

New object added.

### 5.1.3.5 Add a new measurement

In this menu new empty measurements can be set and then added in the structure tree. The type of measurement, measurement function and its parameters are first selected and then added under the selected Structure object.

#### Procedure

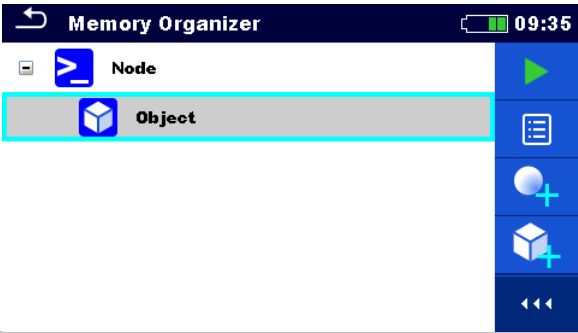
- ①  Select level in structure where measurement will be added.



---

- ②  Select Add measurement in Control panel.

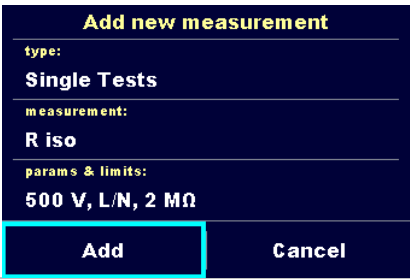

---

- ③  Add new measurement menu.

---

- ③a  Type of test can be selected from this field.  
Options: (Single Tests, Auto Tests)  
Tap on field or press the  key to modify.

---

- ③b  Last added measurement is offered by default.  
To select another measurement press the  to open menu for selecting measurements.

---

- ③c  params & limits: 500 V, L/N, 2 MΩ

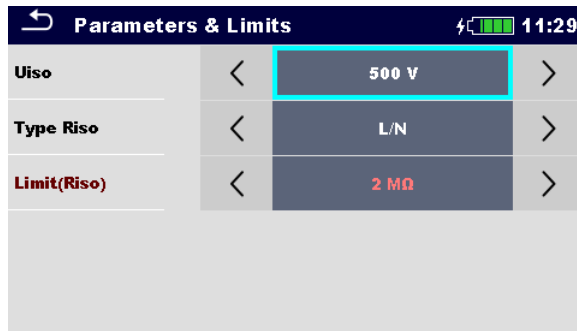

Select parameter and modify it as described earlier.

Refer to chapter **6.1.2 Setting parameters and limits of single tests** for more information.

④



Adds the measurement under the selected Structure object in the tree menu.



Returns to the structure tree menu without changes.

⑤

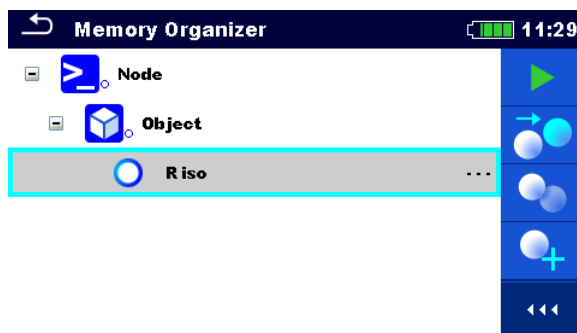



New empty measurement is added under the selected Structure object.

### 5.1.3.6 Clone a Structure object

In this menu selected structure object can be copied (cloned) to same level in the structure tree. Cloned structure object have same name as original.

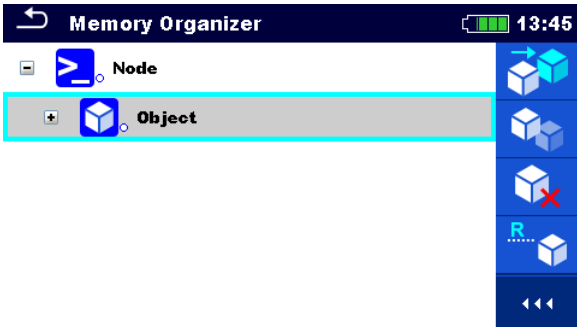
#### Procedure

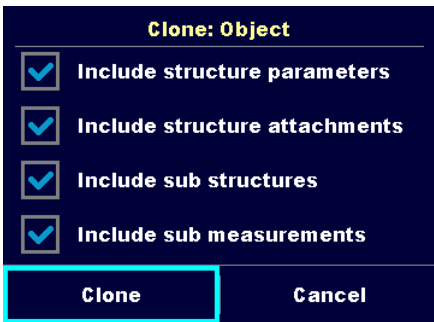
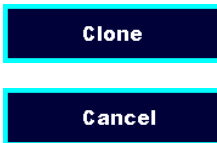
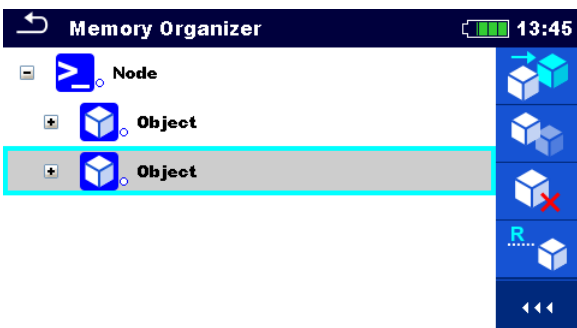
- ①  Select the structure object to be cloned.
- ②  Select Clone in Control panel.
- ③  The Clone Structure object menu is displayed. Sub-elements of the selected structure object can be marked or un-marked for cloning.  
Refer to chapter **5.1.3.9 Cloning and Pasting sub-elements of selected structure object** for more information.
- ④  Selected structure object is copied (cloned) to same level in the structure tree.  
Cloning is cancelled. No changes in the Structure tree.
- ⑤  The new structure object is displayed.

### 5.1.3.7 Clone a measurement

By using this function a selected empty or finished measurement can be copied (cloned) as an empty measurement to the same level in the structure tree.

#### Procedure

①  Select the measurement to be cloned.

The screenshot shows the 'Memory Organizer' application interface. At the top, there is a title bar with a back arrow, the text 'Memory Organizer', a battery icon, and the time '14:09'. Below the title bar is a tree structure with the following nodes: 'Node' (expanded), 'Object' (expanded), 'Dist. Board' (expanded), 'Voltage' (14:05), 'R iso' (14:07, highlighted with a red border), and another 'Object' (expanded). On the right side, there is a control panel with a search icon, a 'Clone' icon (two overlapping circles with an arrow), a 'Copy' icon (two overlapping circles), a 'Paste' icon (two overlapping circles with a plus sign), and a 'Back' icon (two left-pointing arrows).

②  Select Clone in Control panel.

The screenshot shows a close-up of the control panel, specifically the 'Clone' button, which is represented by two overlapping circles with a blue arrow pointing from the left circle to the right circle.

③  A new empty measurement is displayed.





The screenshot shows the 'Memory Organizer' application interface after the cloning process. The tree structure is the same as in step 1, but now there is a new 'R iso' measurement (14:07) added to the tree, highlighted with a red border. The control panel on the right is the same as in step 1.

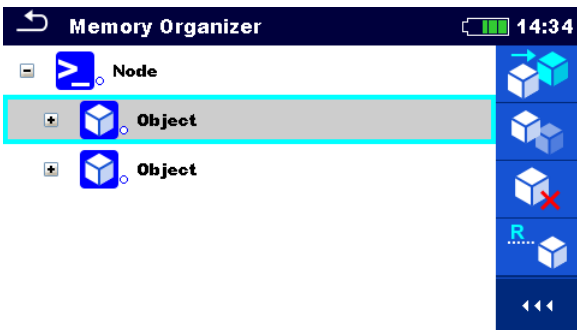

### 5.1.3.8 Copy & Paste a Structure object

In this menu selected Structure object can be copied and pasted to any allowed location in the structure tree.

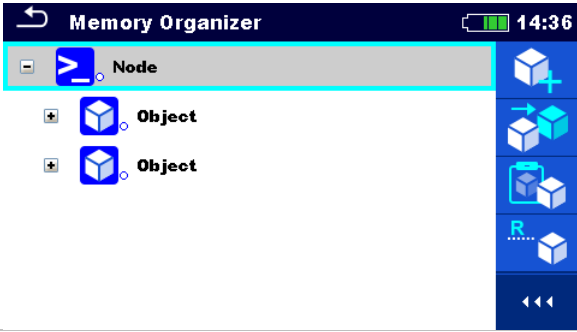
#### Procedure

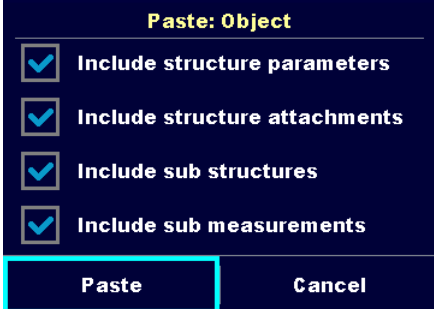
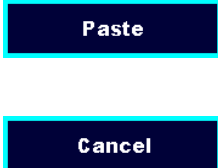
- |   |   |  |
|---|---|--|
| ① |    | Select the structure object to be copied.  |
| ② |    | Select Copy in control panel.  |
| ③ |   | Select location where structure element should be copied.  |
| ④ |  | Select Paste in Control panel.   |
| ⑤ |  | <p>The Paste structure object menu is displayed.</p> <p>Before copying it can be set which sub-elements of the selected structure object will be copied too. Refer to chapter <b>5.1.3.9 Cloning and Pasting sub-elements of selected structure object</b> for more information.</p> |
| ⑥ |  | <p>The selected structure object and elements are copied (pasted) to selected position in the tree structure.</p> <p>Returns to the tree menu without changes.</p>   |

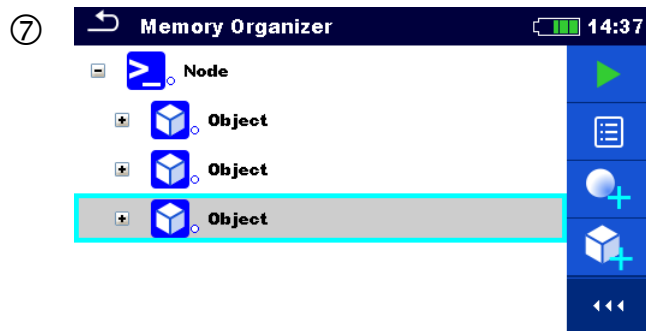

The new structure object is displayed.

**Note**

The Paste command can be executed one or more times.

### 5.1.3.9 Cloning and Pasting sub-elements of selected structure object

When structure object is selected to be cloned, or copied & pasted, additional selection of its sub-elements is needed. The following options are available:





#### Options

<input checked="" type="checkbox"/> <b>Include structure parameters</b>	Parameters of selected structure object will be cloned / pasted too.
<input checked="" type="checkbox"/> <b>Include structure attachments</b>	Attachments of selected structure object will be cloned / pasted too.
<input checked="" type="checkbox"/> <b>Include sub structures</b>	Structure objects in sub-levels of selected structure object will be cloned / pasted too.
<input checked="" type="checkbox"/> <b>Include sub measurements</b>	Measurements in selected structure object and sub-levels will be cloned / pasted too.

### 5.1.3.10 Copy & Paste a measurement

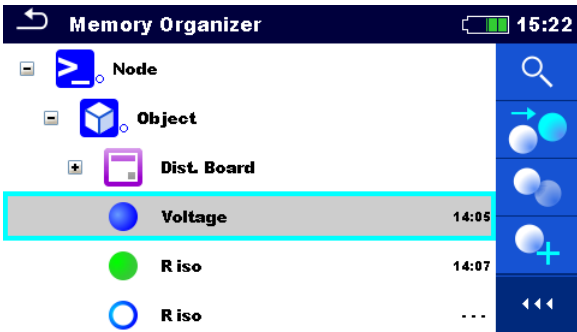
In this menu selected measurement can be copied to any allowed location in the structure tree.

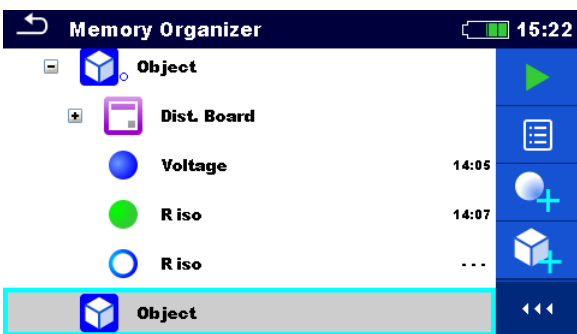
#### Procedure

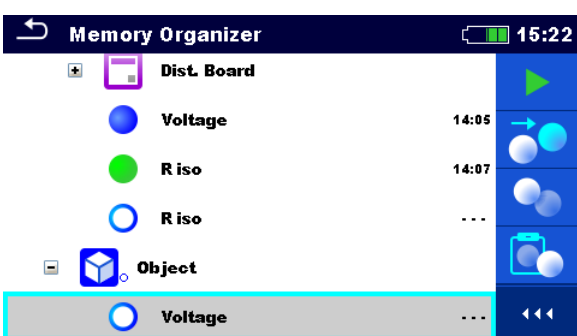
- |   |   |  |
|---|---|--|
| ① |    | Select the measurement to be copied.                                 |
| ② |    | Select Copy in Control panel.  |
| ③ |   | Select the location where measurement should be pasted.              |
| ④ |  | Select Paste in Control panel.                                       |
| ⑤ |  | A new (empty) measurement is displayed in selected Structure object. |

#### Note

The Paste command can be executed one or more times.

### 5.1.3.11 Delete a Structure object

In this menu selected Structure object can be deleted.

#### Procedure

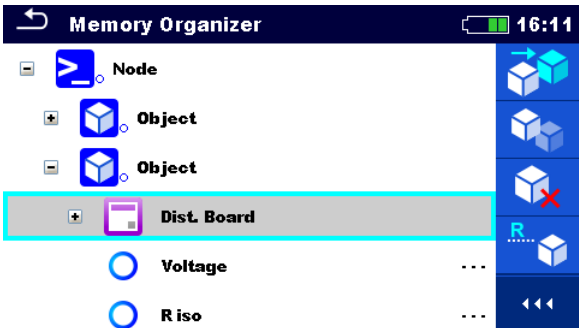
①  Select the structure object to be deleted.

The screenshot shows the 'Memory Organizer' interface. The menu structure is as follows:

- Node
  - Object
    - Object
    - Dist. Board** (highlighted)
    - Voltage
    - R iso

The 'Dist. Board' item is highlighted with a red border. The right-hand control panel shows a 'Delete' icon (a cube with a red X) which is highlighted.

②  Select Delete in Control panel.

The screenshot shows the 'Delete' icon (a blue cube with a red X) selected in the control panel.

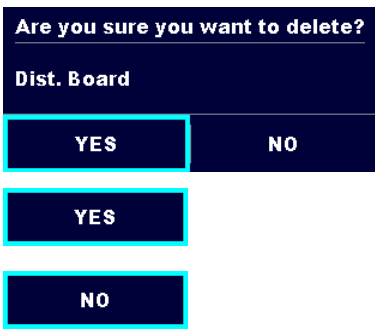
③  A confirmation window will appear.

The screenshot shows a confirmation dialog box with the following content:

Are you sure you want to delete?  
Dist. Board

YES NO

YES

NO

Selected structure object and its sub-elements are removed.

Returns to the tree menu without changes.

④  Structure without deleted object.

The screenshot shows the 'Memory Organizer' interface after the deletion. The menu structure is as follows:

- Node
  - Object
    - Object
    - Voltage
    - R iso
    - R iso

The 'Dist. Board' item has been removed from the menu. The 'Delete' icon in the control panel is no longer highlighted.

### 5.1.3.12 Delete a measurement

In this menu selected measurement can be deleted.



#### Procedure

①	<p>The screenshot shows the 'Memory Organizer' interface. A tree view on the left contains 'Node', 'Object', 'Dist. Board', 'Voltage' (14:05), 'R iso' (14:07), and another 'R iso' (highlighted in cyan). A control panel on the right shows a delete icon (a sphere with a red X) highlighted.</p>	Select a measurement to be deleted.
②	<p>A close-up of the delete icon from the control panel, which is a blue sphere with a red 'X' over it.</p>	Select Delete in Control panel.
③	<p>The screenshot shows a confirmation dialog box with the text 'Are you sure you want to delete?' and 'R iso' below it. There are two buttons: 'YES' (highlighted in cyan) and 'NO'. Below the dialog, two more buttons are shown: 'YES' (highlighted in cyan) and 'NO' (highlighted in cyan).</p>	A confirmation window will appear.
		Selected measurement is deleted.
		Returns to the tree menu without changes.
④	<p>The screenshot shows the 'Memory Organizer' interface after the deletion. The tree view now contains 'Node', 'Object' (highlighted in cyan), 'Dist. Board', 'Voltage' (14:05), 'R iso' (14:07), and 'Object 02'. The control panel on the right shows a play button, a list icon, and a plus icon.</p>	Structure without deleted measurement.

### 5.1.3.13 Rename a Structure object

In this menu selected Structure object can be renamed.

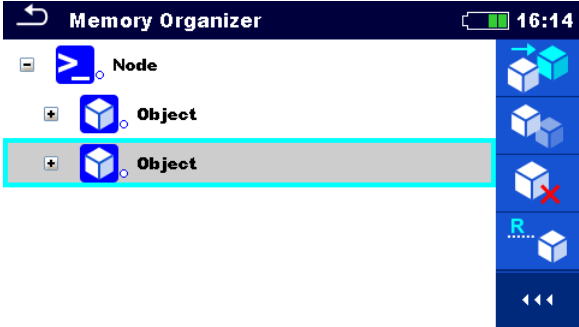
#### Procedure

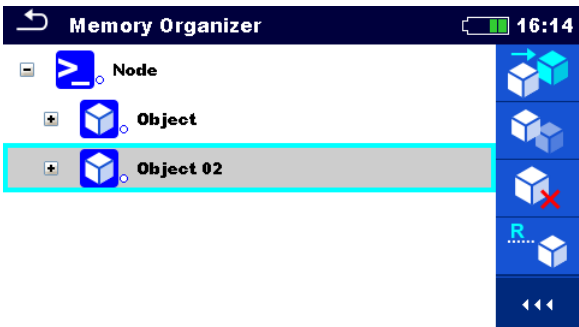
- ①  Select the structure object to be renamed.
- ②  Select Rename in Control panel.
- ③  Virtual keypad will appear on screen. Enter new text and confirm.  
Refer to chapter 4.3 *Virtual keyboard* for keypad operation.
- ④  Structure object with the modified name.

5.1.3.14 Recall and Retest selected measurement

Procedure

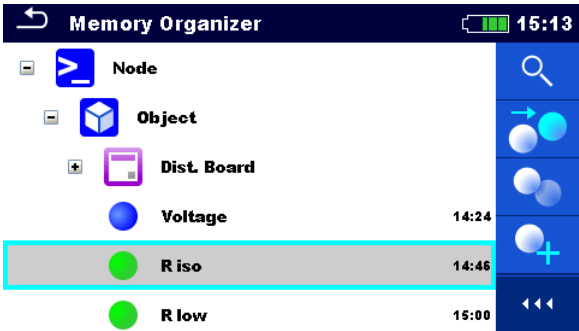
①  Select the measurement to be recalled.

②  Select Recall results in Control panel.

③  Measurement is recalled.

③a  Parameters and limits can be viewed but cannot be edited.

④  Select Retest in Control panel.

⑤  Measurement retest starting screen is displayed.

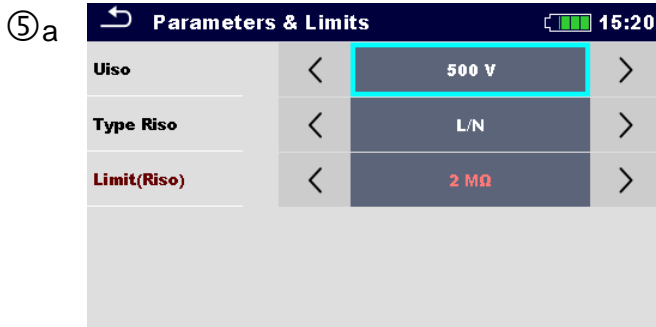

Parameters and limits can be viewed and edited.



Select Run in Control panel to retest the measurement.

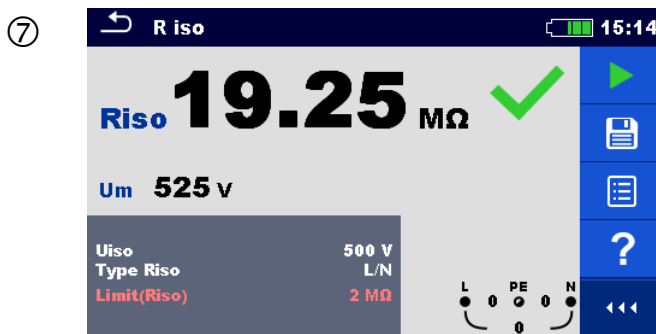

Results / sub-results after re-run of recalled measurement.



Select Save results in Control panel.

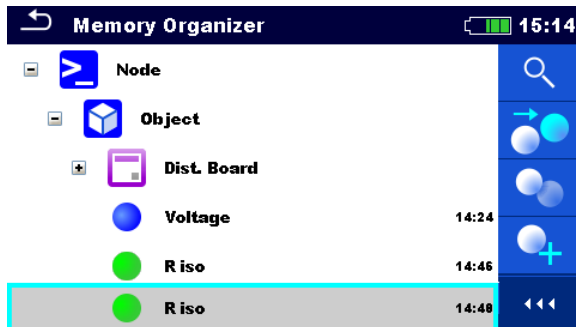

Retested measurement is saved under same structure object as original one.

Refreshed memory structure with the new performed measurement.



## 6 Single tests

Single tests can be selected in the main **Single tests** menu or in **Memory organizer** main menu and sub-menus.

### 6.1 Selection modes

In **Single tests main menu** four modes for selecting single tests are available.

#### Options



#### All

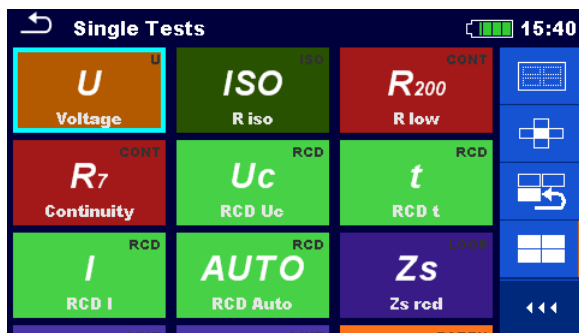

A single test can be selected from a list of all single tests.

The single tests are always displayed in the same (default) order.



#### Last used

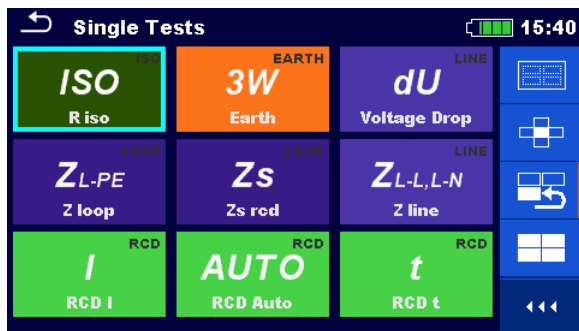

Last 9 made different single tests are displayed.



#### Groups

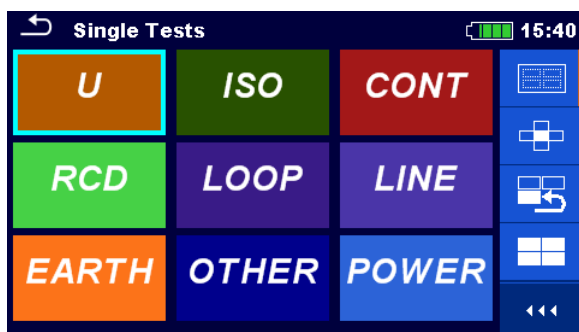

The single tests are divided into groups of similar tests.



**Cross selector**

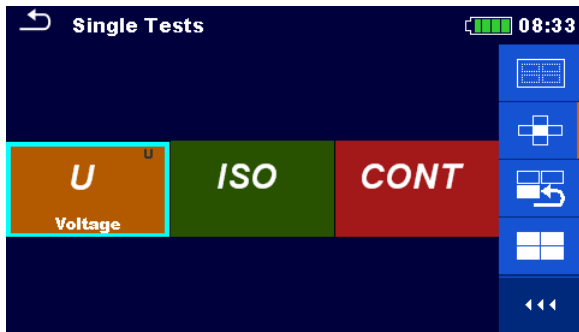

This selection mode is the fastest for working with the keypad.

Groups of single tests are organized in a row.

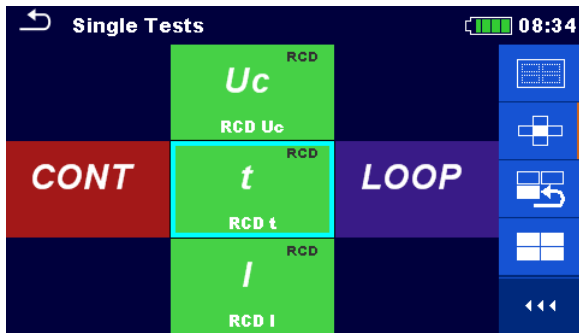

For the selected group all single tests are displayed and easy accessible with up /down keys.



Expands control panel / open more options.

**6.1.1 Single test screens**

In the Single test screens measuring results, sub-results, limits and parameters of the measurement are displayed. In addition on-line statuses, warnings and other info are displayed.



Figure 6.1: Single test screen organization, example of insulation resistance measurement

**Single test screen organization**



Header line:

- › ESC touch key
- › function name
- › battery status
- › real time clock

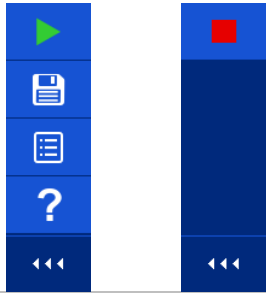

Control panel (available options)



Parameters (white) and limits (red)



Result field:











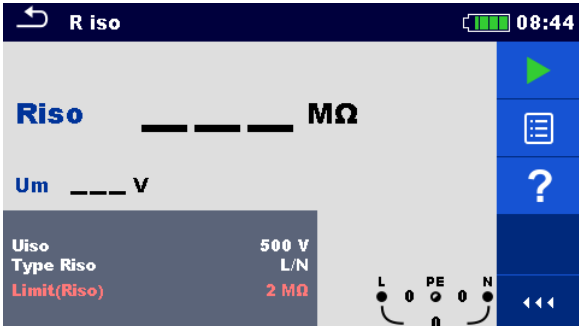

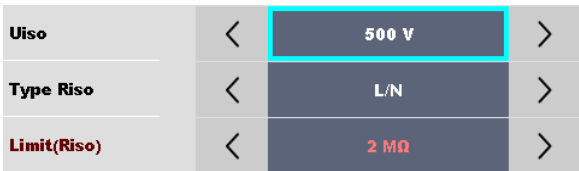
- main result(s)
- sub-result(s)
- PASS / FAIL indication

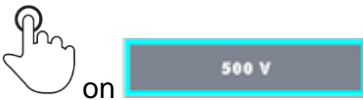

Voltage monitor with info and warning symbols

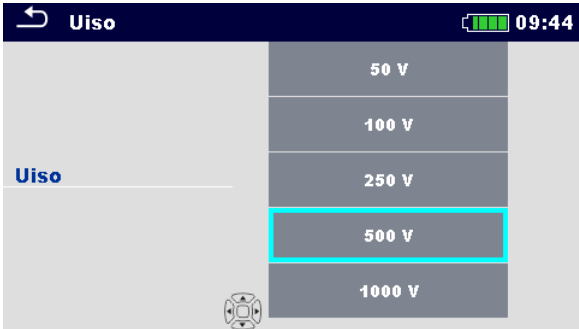
### 6.1.2 Setting parameters and limits of single tests

#### Procedure

- ①  Select the test or measurement.  
The test can be entered from:
- Single tests menu or
  - Memory organizer menu once the empty measurement was created in selected object structure.
- 
- ②  Select Parameters in Control panel.
- 
- ③  Select parameter to be edited or limit to be set.
-  on 
- Set parameter or limit value.
- 
- 
- ③a  on  Enters Set value menu.
- 
- 
- ③b  Set value menu.
- 
- ③c  on  Accepts a new parameter or limit value and exits.
- 



Accepts the new parameters and limit values and exits.

### 6.1.3 Single test start screen

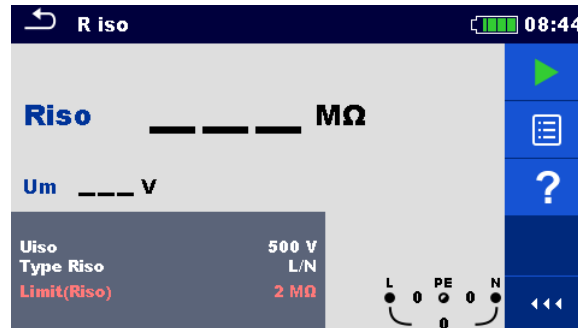

Figure 6.2: Single test start screen, example of insulation resistance measurement

Options (before test, screen was opened in Memory organizer or Single test main menu):



Starts the measurement.



long

Starts the continuous measurement (if applicable on selected single test).



long



Opens help screens.



Opens menu for changing parameters and limits.

Refer to chapter **6.1.2 Setting parameters and limits of single tests** for more information.



on



Enters cross selector to select test or measurement.



long on



Expands column in control panel.



### 6.1.4 Single test screen during test

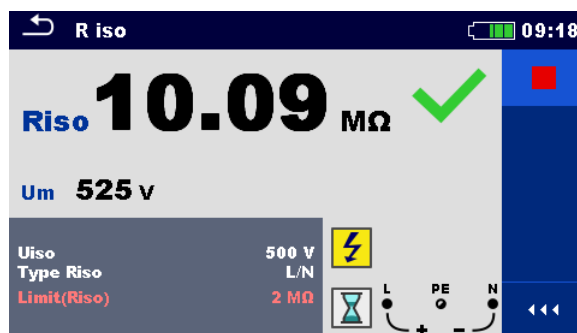

Figure 6.3: Single test is running, example of insulation resistance continuous measurement

Operations when test is running:



Stops the single test measurement.



Proceeds to next step of the measurement (if measurement consists of more steps).



Previous value.



Next value.



Stops or aborts the measurement and returns one menu back.



## 6.1.5 Single test result screen

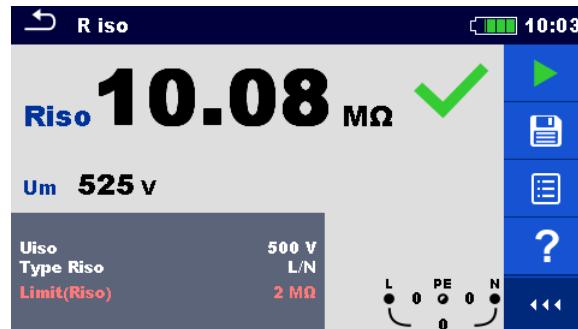

Figure 6.4: Single test results screen, example of insulation resistance measurement results

### Options (after measurement is finished)



Starts a new measurement.



long

Starts a new continuous measurement (if applicable on selected single test).



long



Saves the result.



A new measurement was selected and started from a Structure object in the structure tree:

- the measurement will be saved under the selected Structure object.

A new measurement was started from the Single test main menu:

- saving under the last selected Structure object will be offered by default. The user can select another Structure object or create a new Structure object.
- By pressing the  key in Memory organizer menu the measurement is saved under selected location.

An empty measurement was selected in structure tree and started:

- the result(s) will be added to the measurement. The measurement will change its status from 'empty' to 'finished'.

An already carried out measurement was selected in structure tree, viewed and then restarted:

- a new measurement will be saved under the selected Structure object.



Opens help screens.



Opens screen for changing parameters and limits.

Refer to chapter **6.1.2 Setting parameters and limits of single tests** for more information.



Enters cross selector to select test or measurement.



Expands column in control panel.





## 6.1.6 Editing graphs (Harmonics)

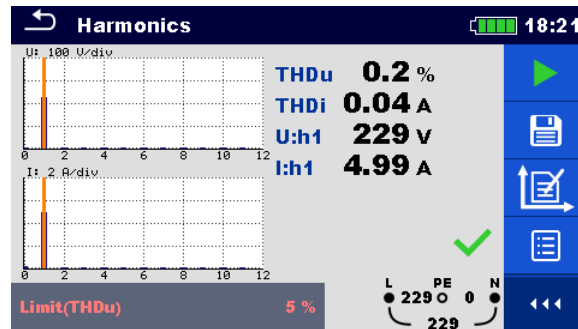

Figure 6.5: Example of Harmonics measurement results

### Options for editing graphs (start screen or after measurement is finished)



Plot edit

Opens control panel for editing graphs.



Increase scale factor for y-axis.



Decrease scale factor for y-axis.



Toggle between U and I graph to set scale factor



Exits from editing graphs.

## 6.1.7 Help screens

Help screens contain diagrams for proper connection of the instrument.

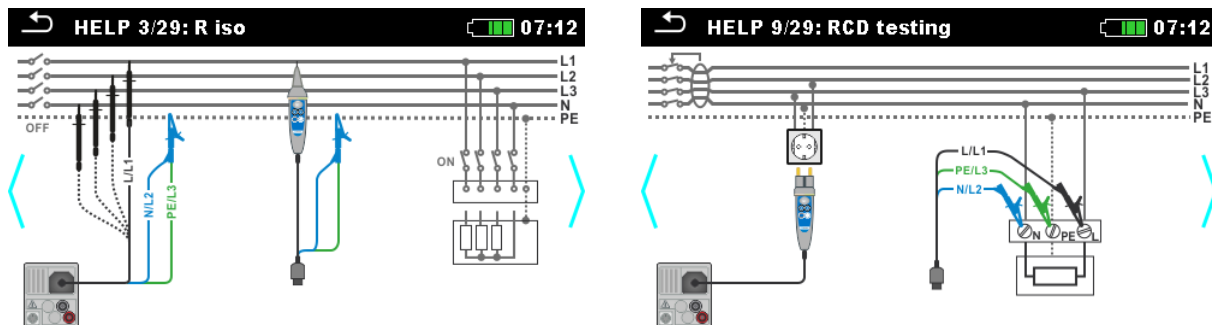
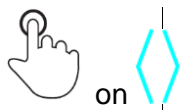

Figure 6.6: Examples of help screens

### Options



Goes to previous / next help screen.



Back to test / measurement menu.

## 6.1.8 Recall single test results screen

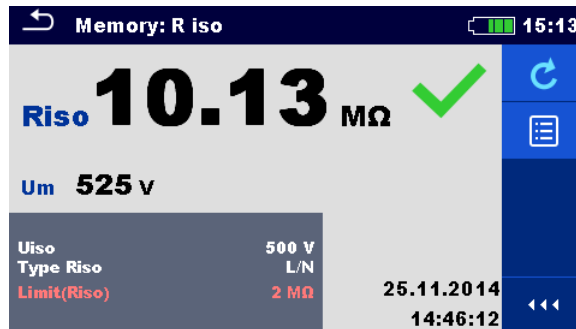

Figure 6.7: Recalled results of selected measurement, example of insulation resistance recalled results

### Options



Retest

Enters starting screen for a new measurement.

Refer to chapter **6.1.3 Single test start screen** for more information.



Opens menu for viewing parameters and limits.

Refer to chapter **6.1.2 Setting parameters and limits of single tests** for more information.



on

Uiso	500 V
Type Riso	L/N
Limit(Riso)	2 MΩ



Expands column in control panel.



# 7 Tests and measurements

See chapter 6.1 Selection modes for instructions on keys and touch screen functionality.

## 7.1 Voltage, frequency and phase sequence

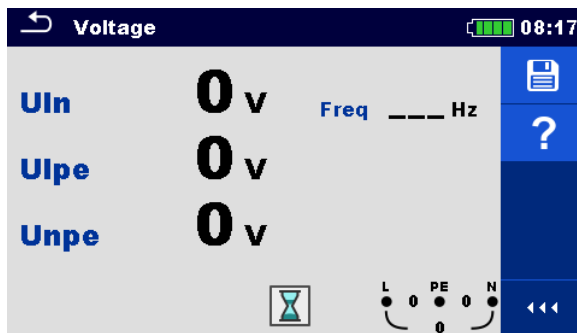

Figure 7.1: Voltage measurement menu

### Measurement parameters / limits

There are no parameters / limits to be set.

### Connection diagrams

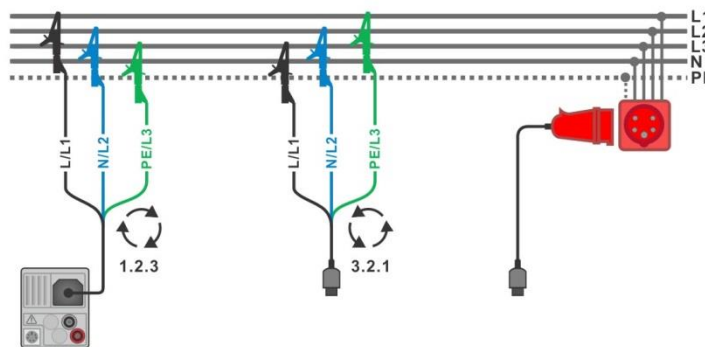

Figure 7.2: Connection of 3-wire test lead and optional adapter in three-phase system

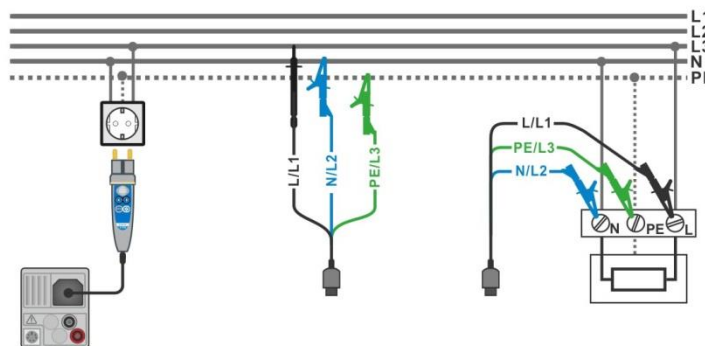

Figure 7.3: Connection of Plug commander and 3-wire test lead in single-phase system

### Measurement procedure

- › Enter the **Voltage** function.
- › Connect test cable to the instrument.
- › Connect test leads to object under test (see **Figure 7.2** and **Figure 7.3**).

- › Measurement runs immediately after entering to menu.
- › Save results (optional).



Figure 7.4: Examples of Voltage measurement in single-phase system

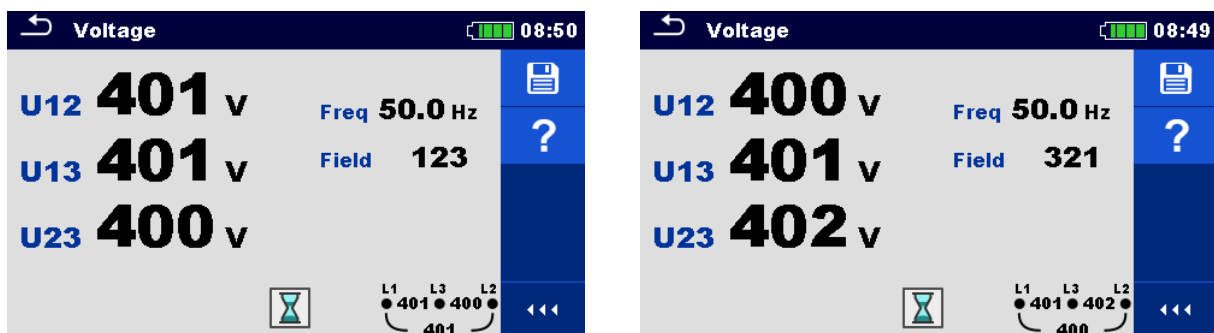

Figure 7.5: Examples of Voltage measurement in three-phase system

### Measurement results / sub-results

#### Single-phase system

<b>UIn</b>	voltage between phase and neutral conductors
<b>Uipe</b>	voltage between phase and protective conductors
<b>Unpe</b>	voltage between neutral and protective conductors
<b>Freq</b>	frequency

#### Three-phase system

<b>U12</b>	voltage between phases L1 and L2
<b>U13</b>	voltage between phases L1 and L3
<b>U23</b>	voltage between phases L2 and L3
<b>Freq</b>	frequency
<b>Field</b>	1.2.3 - correct connection – CW rotation sequence 3.2.1 - invalid connection – CCW rotation sequence

#### IT earthing system (selection of IT earthing system required)

<b>U12</b>	voltage between phases L1 and L2
<b>U1pe</b>	voltage between phase L1 and PE
<b>U2pe</b>	voltage between phase L2 and PE
<b>Freq</b>	frequency

## 7.2 R iso – Insulation resistance

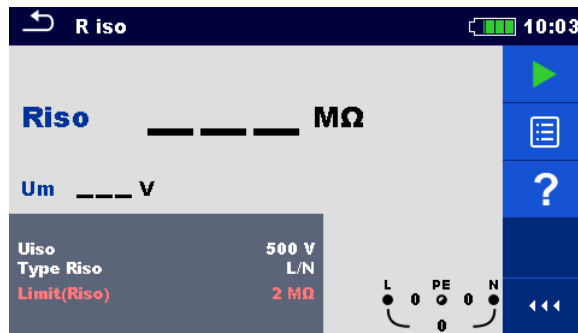

Figure 7.6: Insulation resistance measurement menu

### Measurement parameters / limits

<b>Uiso</b>	<b>Nominal test voltage</b> [50 V, 100 V, 250 V, 500 V, 1000 V, 2500 V*]
<b>Type Riso</b>	<b>Type of test</b> [L/PE, L/N, N/PE, L/L]
<b>Limit(Riso)</b>	<b>Min. insulation resistance</b> [Off, 0.01 MΩ ... 100 MΩ]

\* Nominal test voltage 2500 V is available on MI 3152H only.

### Connection diagrams

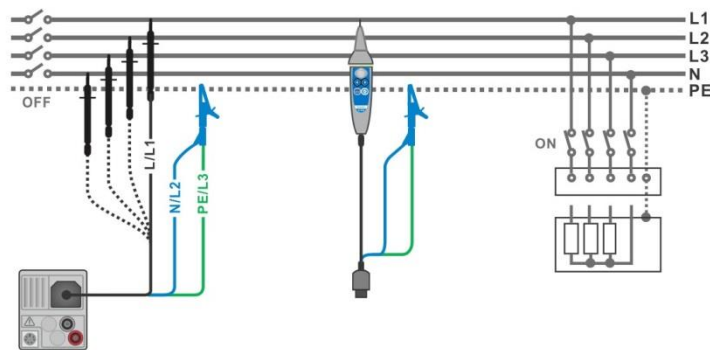

Figure 7.7: Connection of 3-wire test lead and Tip commander ( $U_N \leq 1$  kV)

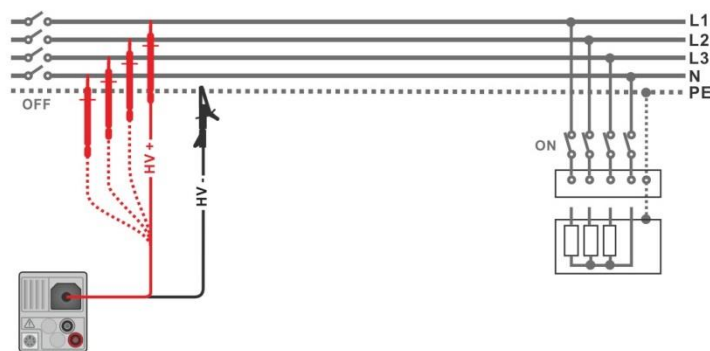

Figure 7.8: Connection of 2.5 kV test lead ( $U_N = 2.5$  kV)

## Measurement procedure

- › Enter the **R iso** function.
- › Set test parameters / limits.
- › Disconnect tested installation from mains supply and discharge installation as required.
- › Connect test cable to the instrument.
- › Connect test leads to object under test (see **Figure 7.7** and **Figure 7.8**).  
Different test cable must be used for testing with nominal test voltage  $U_N \leq 1000$  V and  $U_N = 2500$  V. Also different test terminals are used.  
The standard 3-wire test lead, Schuko test cable or Plug / Tip commanders can be used for the insulation test with nominal test voltages  $\leq 1000$  V. For the 2500 V insulation test the two wire 2.5 kV test lead should be used.
- › Start the measurement. A longer press on TEST key or a longer press on “Start test” option on touch screen starts a continuous measurement.
- › Stop the measurement. Wait until object under test is fully discharged.
- › Save results (optional).



Figure 7.9: Examples of Insulation resistance measurement result

## Measurement results / sub-results

**Riso** Insulation resistance

**Um** Actual test voltage

### 7.3 The DAR and PI diagnostic (MI 3152H only)

**DAR** (**D**ielectric **A**bsorption **R**ation) is ratio of insulation resistance values measured after 15 seconds and after 1 minute. The DC test voltage is present during the whole period of the measurement.

$$DAR = \frac{R_{ISO}(1 \text{ min})}{R_{ISO}(15 \text{ s})}$$

**PI** (**P**olarization **I**ndex) is the ratio of insulation resistance values measured after 1 minute and after 10 minutes. The DC test voltage is present during the whole period of the measurement

$$PI = \frac{R_{ISO}(10 \text{ min})}{R_{ISO}(1 \text{ min})}$$

For additional information regarding PI and DAR diagnostic, please refer to Metrel's handbook **Modern insulation testing**.

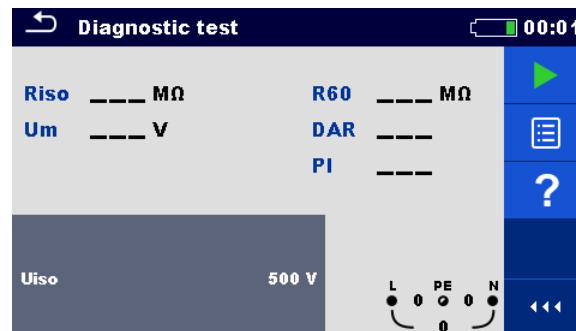

Figure 7.10: Diagnostic test menu

#### Measurement parameters / limits

Uiso	Nominal test voltage [500 V, 1000 V, 2500 V]
------	--

#### Connection diagrams

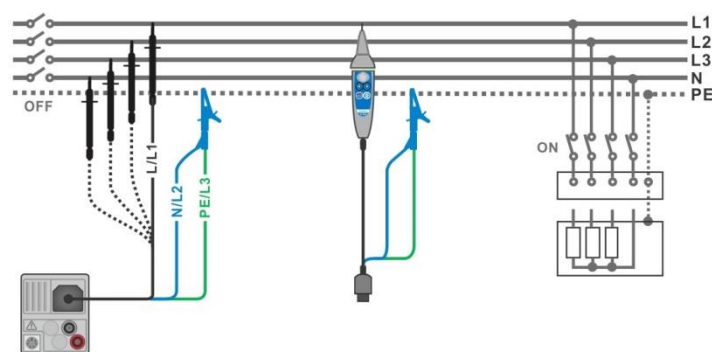
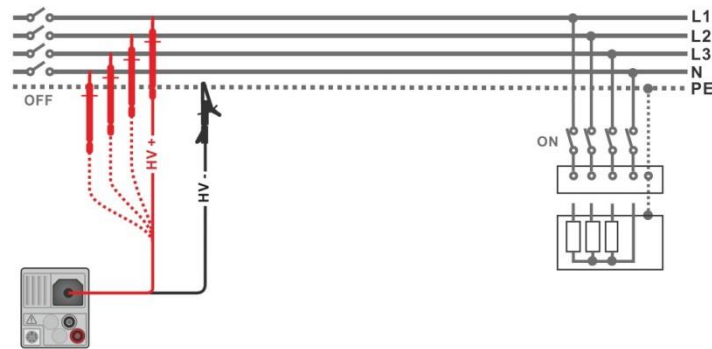

Figure 7.11: Connection of 3-wire test lead and Tip commander ( $U_N \leq 1 \text{ kV}$ )



Figure 7.12: Connection of 2.5 kV test lead ( $U_N = 2.5 \text{ kV}$ )

### Measurement procedure

- › Enter the **Diagnostic test** function.
- › Set test parameters / limits.
- › Disconnect tested installation from mains supply and discharge installation as required.
- › Connect test cable to the instrument.
- › Connect test leads to object under test (see **Figure 7.11** and **Figure 7.12**).  
Different test cable must be used for testing with nominal test voltage  $U_N \leq 1000 \text{ V}$  and  $U_N = 2500 \text{ V}$ . Also different test terminals are used.  
The standard 3-wire test lead, Schuko test cable or Plug / Tip commanders can be used for the insulation test with nominal test voltages  $\leq 1000 \text{ V}$ . For the 2500 V insulation test the two wire 2.5 kV test lead should be used.
- › Start the measurement. Internal timer begins to increment. When internal timer reaches 1 min R60 and DAR factor are displayed and short beep is generated. Measurement can be interrupted at any time.
- › When internal timer reaches 10 min also PI factor is displayed and measurement is completed. Wait until object under test is fully discharged.
- › After the measurement is finished wait until tested item is fully discharged.
- › Save results (optional).

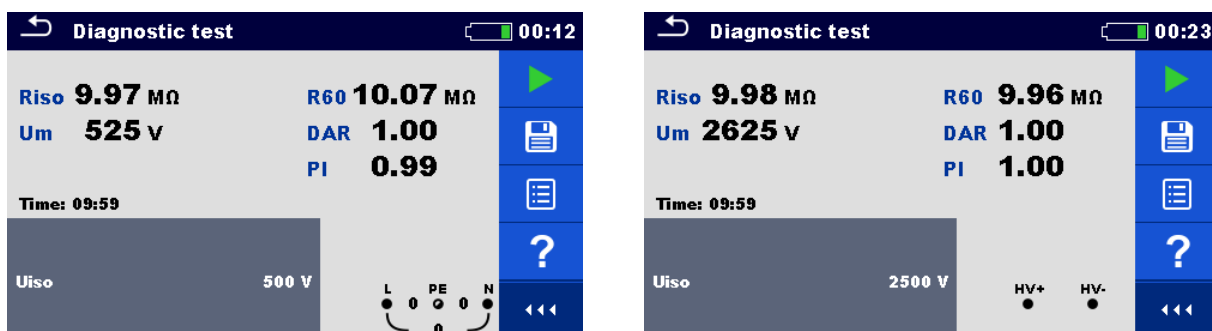

Figure 7.13: Examples of Diagnostic test result

### Measurement results / sub-results

<b>Riso</b>	Insulation resistance
<b>Um</b>	Actual test voltage
<b>R60</b>	Resistance after 60 seconds
<b>DAR</b>	Dielectric absorption ratio
<b>PI</b>	Polarization index

## 7.4 R low – Resistance of earth connection and equipotential bonding

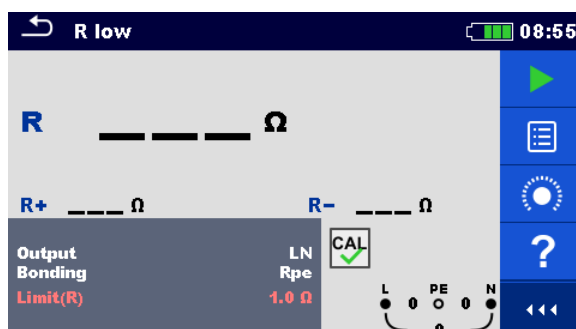

Figure 7.14: R low measurement menu

### Measurement parameters / limits

Output	[LN]
Bonding	[Rpe, Local]
Limit(R)	Max. resistance [Off, 0.1 Ω ... 20.0 Ω]

### Connection diagram

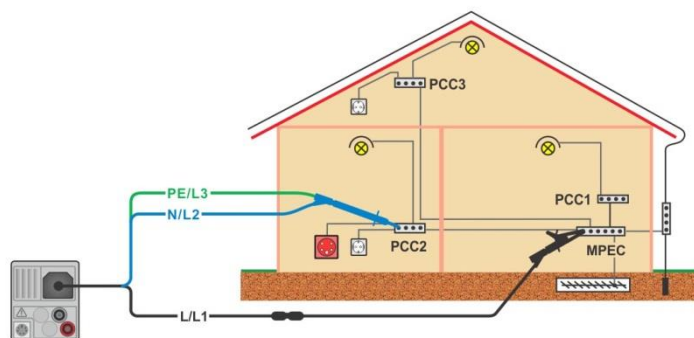

Figure 7.15: Connection of 3-wire test lead plus optional Extension lead

### Measurement procedure

- › Enter the **R low** function.
- › Set test parameters / limits.
- › Connect test cable to the instrument.
- › Compensate the test leads resistance if necessary, see section **7.5.1 Compensation of test leads resistance**.
- › Disconnect tested installation from mains supply and discharge insulation as required.
- › Start the measurement.
- › Save results (optional).

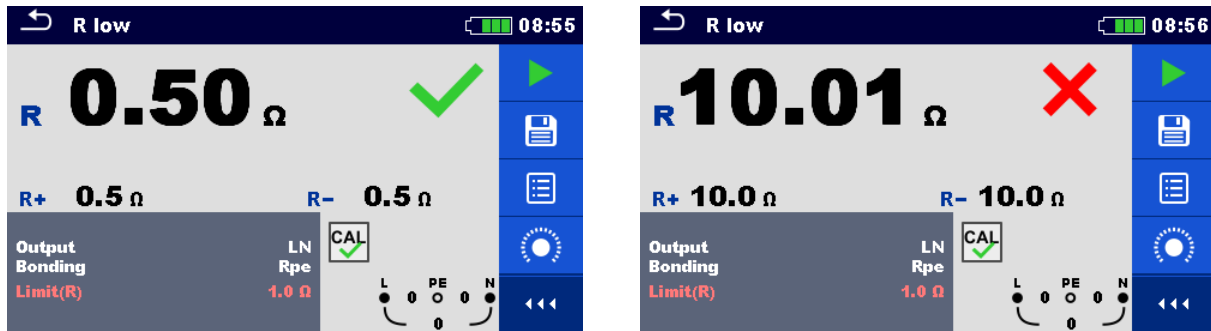

Figure 7.16: Examples of R low measurement result

### Measurement results / sub-results

R	Resistance
R+	Result at positive test polarity
R-	Result at negative test polarity

## 7.5 Continuity – Continuous resistance measurement with low current

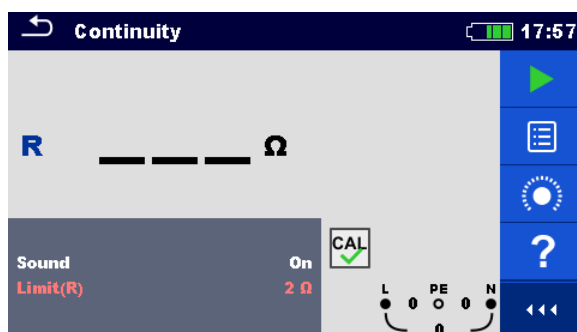

Figure 7.17: Continuity resistance measurement menu

### Measurement parameters / limits

Sound [On\*, Off]

Limit(R) Max. resistance [Off, 0.1 Ω ... 20.0 Ω]

\*Instrument sounds if resistance is lower than the set limit value.

### Connection diagrams

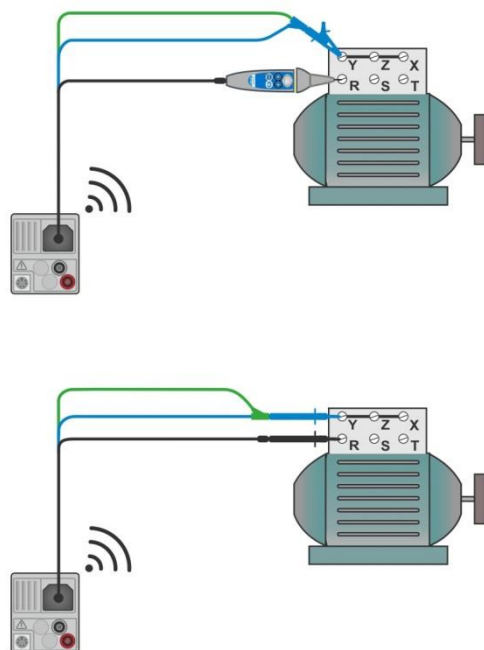

Figure 7.18: Tip commander and 3-wire test lead applications

### Measurement procedure

- Enter the **Continuity** function.
- Set test parameters / limits.
- Connect test cable to the instrument.

- › Compensate the test leads resistance if necessary, see section **7.5.1 Compensation of test leads resistance**.
- › Disconnect device under test from mains supply and discharge it as required.
- › Connect test leads to device under test, see **Figure 7.18**.
- › Start the measurement.
- › Stop the measurement.
- › Save results (optional).

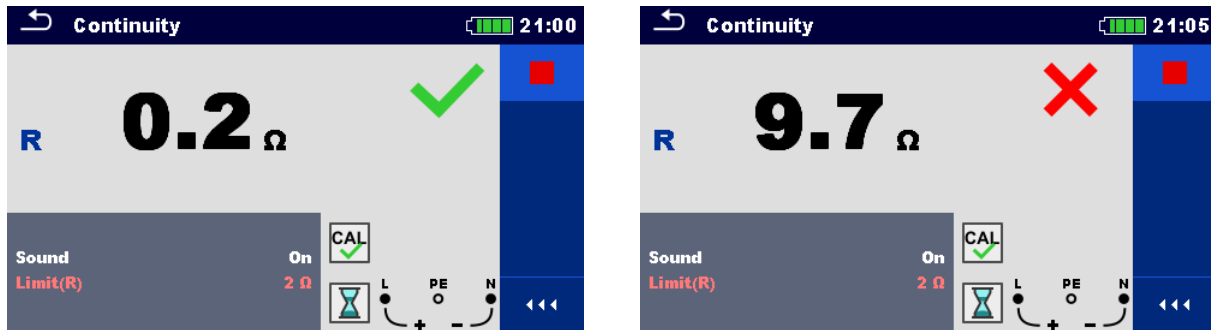

Figure 7.19: Examples of Continuity resistance measurement result

## Measurement results / sub-results

R Resistance

### 7.5.1 Compensation of test leads resistance

This chapter describes how to compensate the test leads resistance in **R low** and **Continuity** functions. Compensation is required to eliminate the influence of test leads resistance and the internal resistances of the instrument on the measured resistance. The lead compensation is therefore a very important feature to obtain correct result.

 symbol is displayed if the compensation was carried out successfully.

#### Connections for compensating the resistance of test leads

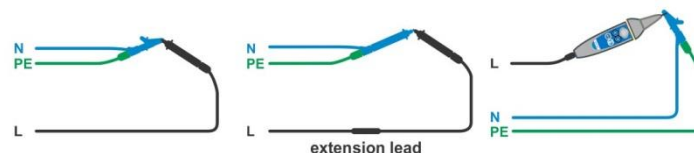

Figure 7.20: Shorted test leads

#### Compensation of test leads resistance procedure

- › Enter **R low** or **Continuity** function.
- › Connect test cable to the instrument and short the test leads together, see **Figure 7.20**.

- › Touch the  key to compensate leads resistance.

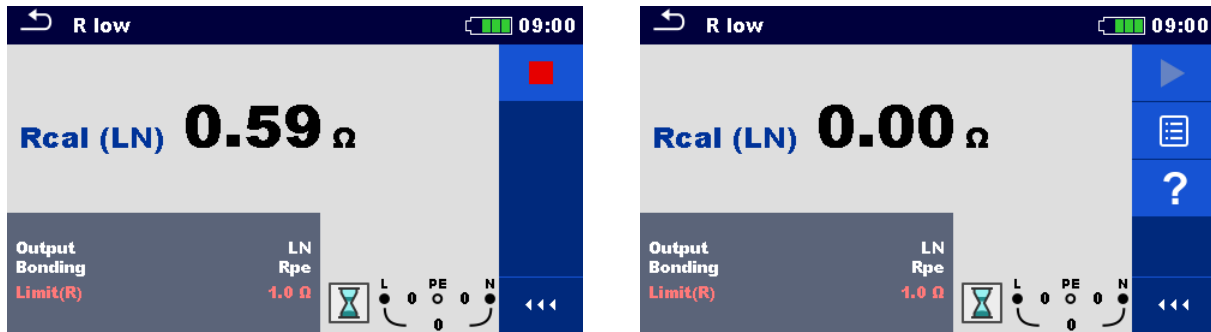

Figure 7.21: Result with old and new calibration values

## 7.6 Testing RCDs

Various test and measurements are required for verification of RCD(s) in RCD protected installations. Measurements are based on the EN 61557-6 standard.

The following measurements and tests (sub-functions) can be performed:

- › Contact voltage,
- › Trip-out time,
- › Trip-out current and
- › RCD Auto test.

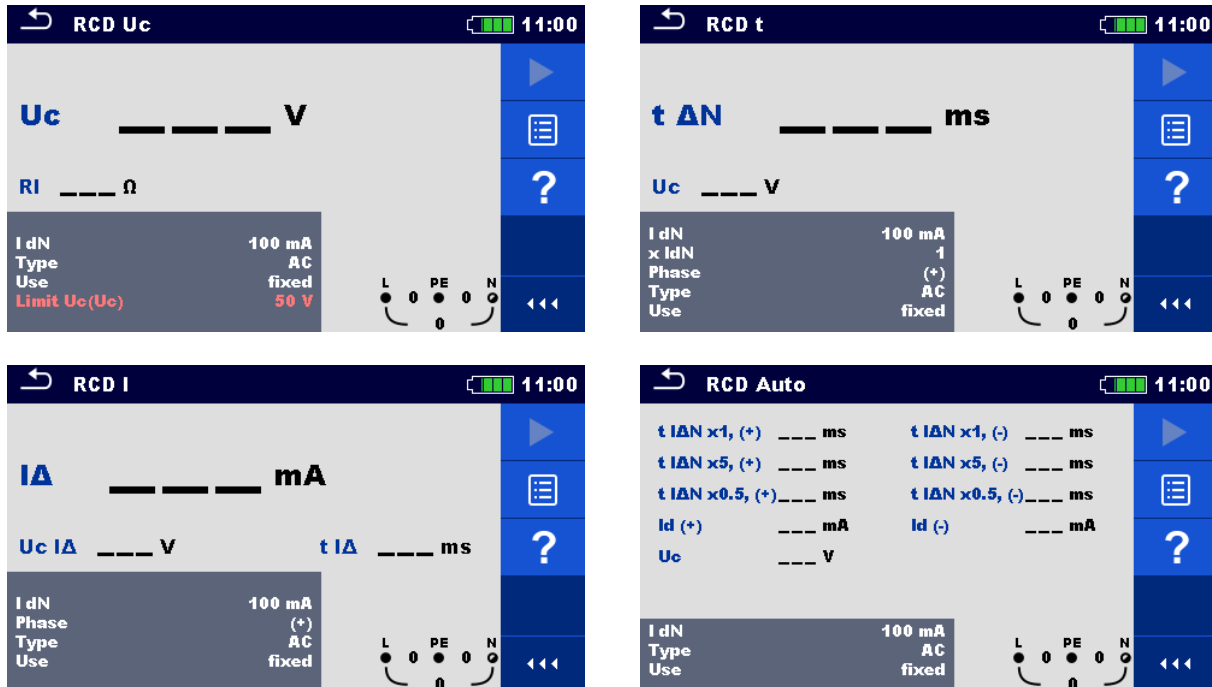

Figure 7.22: RCD menus

### Test parameters / limits

<b>I dN</b>	<b>Rated RCD residual current sensitivity</b> [10 mA, 30 mA, 100 mA, 300 mA, 500 mA, 1000 mA]
<b>Type</b>	<b>RCD type</b> [AC, A, F, B*, B+*]
<b>Use</b>	<b>RCD / PRCD selection</b> [fixed, PRCD, PRCD-S, PRCD-K]
<b>Selectivity</b>	<b>Characteristic</b> [G, S]
<b>X IdN</b>	<b>Multiplication factor for test current</b> [0.5, 1, 2, 5]
<b>Phase</b>	<b>Starting polarity</b> [+ , -]
<b>Limit Uc</b>	<b>Conventional touch voltage limit</b> [25 V, 50 V]

\* Model MI 3152 only.

### Connection diagram

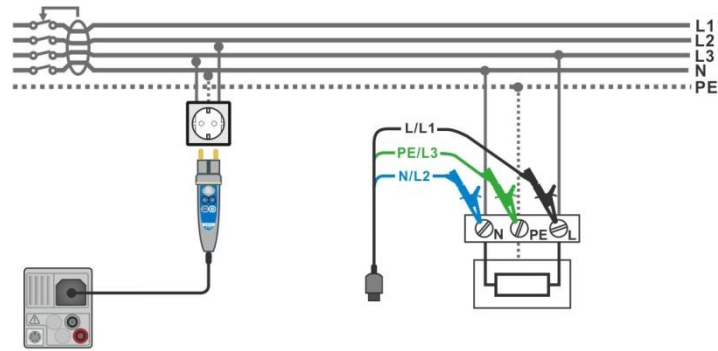

Figure 7.23: Connecting the Plug commander and the 3-wire test lead

## 7.6.1 RCD Uc – Contact voltage

### Test procedure

- › Enter the **RCD Uc** function.
- › Set test parameters / limits.
- › Connect test cable to the instrument.
- › Connect test leads or Plug commander to the object under test, see **Figure 7.23**.
- › Start the measurement.
- › Save results (optional).

The contact voltage result relates to the rated nominal residual current of the RCD and is multiplied by an appropriate factor (depending on RCD type and type of test current). The 1.05 factor is applied to avoid negative tolerance of result. See **Table 7.1** for detailed contact voltage calculation factors.

RCD type		Contact voltage $U_c$ proportional to	Rated $I_{\Delta N}$	Notes
AC	G	$1.05 \times I_{\Delta N}$	any	All models
AC	S	$2 \times 1.05 \times I_{\Delta N}$		
A, F	G	$1.4 \times 1.05 \times I_{\Delta N}$	$\geq 30$ mA	
A, F	S	$2 \times 1.4 \times 1.05 \times I_{\Delta N}$	< 30 mA	
A, F	G	$2 \times 1.05 \times I_{\Delta N}$		
A, F	S	$2 \times 2 \times 1.05 \times I_{\Delta N}$		
B, B+	G	$2 \times 1.05 \times I_{\Delta N}$	any	Model MI 3152 only
B, B+	S	$2 \times 2 \times 1.05 \times I_{\Delta N}$		

**Table 7.1: Relationship between  $U_c$  and  $I_{\Delta N}$**

Fault Loop resistance is indicative and calculated from  $U_c$  result (without additional proportional factors) according to:  $R_L = \frac{U_c}{I_{\Delta N}}$ .



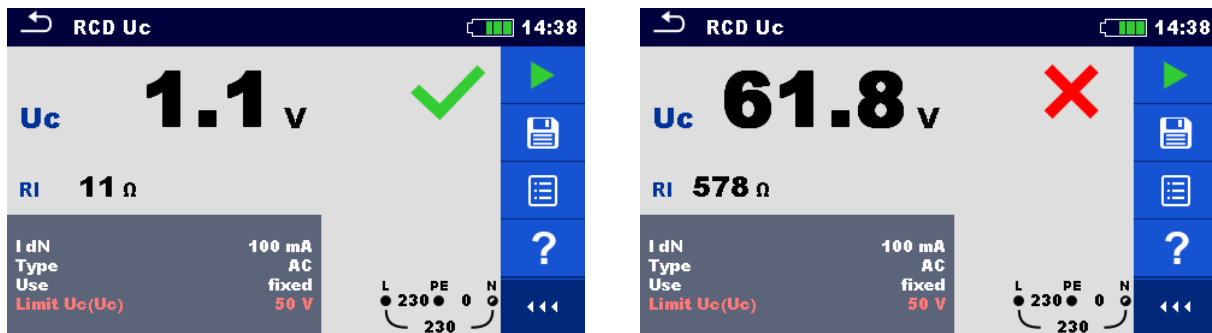

Figure 7.24: Examples of Contact voltage measurement result

### Test result / sub-results

<b>Uc</b>	Contact voltage
<b>RI</b>	Calculated fault loop resistance

## 7.6.2 RCD t – Trip-out time

### Test procedure

- › Enter the **RCD t** function.
- › Set test parameters / limits.
- › Connect test cable to the instrument.
- › Connect test leads or Plug commander to the object under test, see **Figure 7.23**.
- › Start the measurement.
- › Save results (optional).

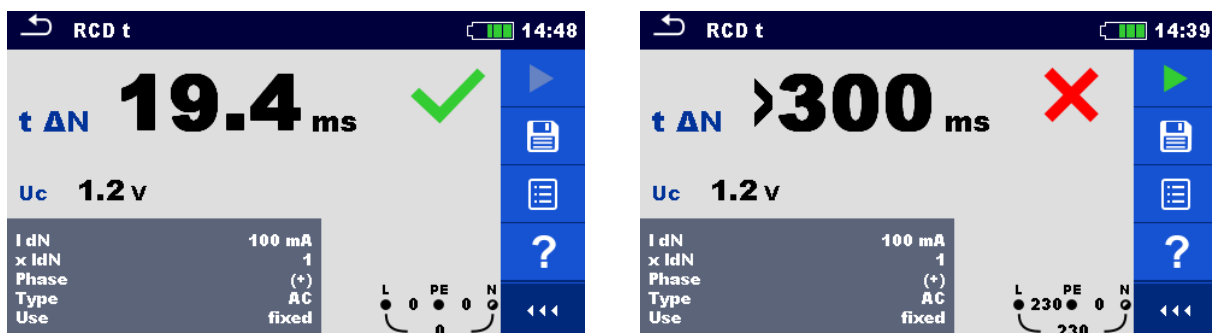

Figure 7.25: Examples of Trip-out time measurement result

### Test results / sub-results

<b>t ΔN</b>	Trip-out time
<b>Uc</b>	Contact voltage for rated $I_{\Delta N}$

### 7.6.3 RCD I – Trip-out current

The instrument increases the test current in small steps through appropriate range as follows:

RCD type	Slope range		Waveform	Notes
	Start value	End value		
AC	$0.2 \times I_{\Delta N}$	$1.1 \times I_{\Delta N}$	Sine	All models
A, F ( $I_{\Delta N} \geq 30$ mA)	$0.2 \times I_{\Delta N}$	$1.5 \times I_{\Delta N}$	Pulsed	
A, F ( $I_{\Delta N} = 10$ mA)	$0.2 \times I_{\Delta N}$	$2.2 \times I_{\Delta N}$		
B, B+	$0.2 \times I_{\Delta N}$	$2.2 \times I_{\Delta N}$	DC	Model MI 3152 only

Maximum test current is  $I_{\Delta}$  (trip-out current) or end value in case the RCD didn't trip-out.

#### Test procedure

- › Enter the **RCD I** function.
- › Set test parameters / limits.
- › Connect test cable to the instrument.
- › Connect test leads or Plug commander to the object under test, see **Figure 7.23**.
- › Start the measurement.
- › Save results (optional).

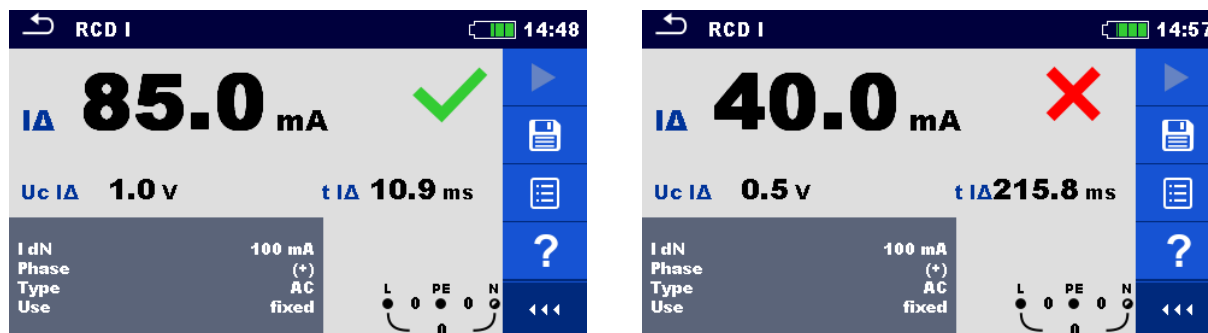

Figure 7.26: Examples of Trip-out current measurement result

#### Test results / sub-results

<b>I<math>\Delta</math></b>	Trip-out current
<b>Uc I<math>\Delta</math></b>	Contact voltage at trip-out current $I_{\Delta}$ or end value if the RCD didn't trip
<b>t I<math>\Delta</math></b>	Trip-out time at trip-out current $I_{\Delta}$

## 7.7 RCD Auto – RCD Auto test

RCD Auto test function performs a complete RCD test (trip-out time at different residual currents, trip-out current and contact voltage) in one set of automatic tests, guided by the instrument.

### RCD Auto test procedure

RCD Auto test steps	Notes
<ul style="list-style-type: none"> <li>› Enter the <b>RCD Auto</b> function.</li> <li>› Set test parameters / limits.</li> <li>› Connect test cable to the instrument.</li> <li>› Connect test leads or Plug commander to the object under test, see <b>Figure 7.23</b></li> <li>› Start the measurement.</li> </ul>	Start of test
Test with $I_{\Delta N}$ , (+) positive polarity (step 1).	RCD should trip-out
› <b>Re-activate RCD.</b>	
Test with $I_{\Delta N}$ , (-) negative polarity (step 2).	RCD should trip-out
› <b>Re-activate RCD.</b>	
Test with $5 \times I_{\Delta N}$ , (+) positive polarity (step 3).	RCD should trip-out
› <b>Re-activate RCD.</b>	
Test with $5 \times I_{\Delta N}$ , (-) negative polarity (step 4).	RCD should trip-out
› <b>Re-activate RCD.</b>	
Test with $\frac{1}{2} \times I_{\Delta N}$ , (+) positive polarity (step 5).	RCD should not trip-out
Test with $\frac{1}{2} \times I_{\Delta N}$ , (-) negative polarity (step 6).	RCD should not trip-out
Trip-out current test, (+) positive polarity (step 7).	RCD should trip-out
› <b>Re-activate RCD.</b>	
Trip-out current test, (-) negative polarity (step 8).	RCD should trip-out
› <b>Re-activate RCD.</b>	
Save results (optional).	End of test

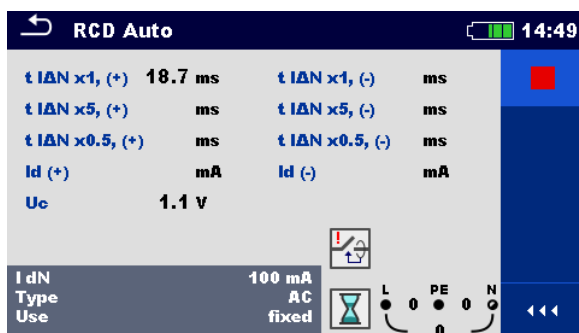

Step 1

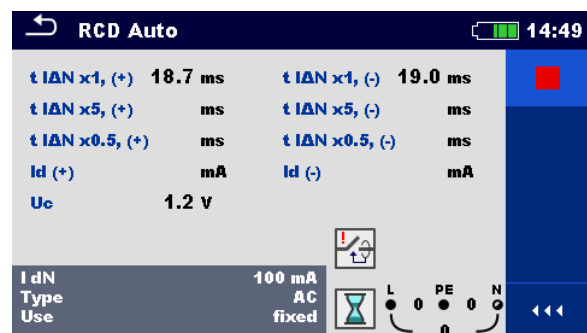

Step 2



Figure 7.27: Individual steps in RCD Auto test

### Test results / sub-results

$t I_{\Delta N} \times 1, (+)$	Step 1 trip-out time ( $I_{\Delta} = I_{\Delta N}, (+)$ positive polarity)
$t I_{\Delta N} \times 1, (-)$	Step 2 trip-out time ( $I_{\Delta} = I_{\Delta N}, (-)$ negative polarity)
$t I_{\Delta N} \times 5, (+)$	Step 3 trip-out time ( $I_{\Delta} = 5 \times I_{\Delta N}, (+)$ positive polarity)
$t I_{\Delta N} \times 5, (-)$	Step 4 trip-out time ( $I_{\Delta} = 5 \times I_{\Delta N}, (-)$ negative polarity)
$t I_{\Delta N} \times 0.5, (+)$	Step 5 trip-out time ( $I_{\Delta} = \frac{1}{2} \times I_{\Delta N}, (+)$ positive polarity)
$t I_{\Delta N} \times 0.5, (-)$	Step 6 trip-out time ( $I_{\Delta} = \frac{1}{2} \times I_{\Delta N}, (-)$ negative polarity)
$I_d (+)$	Step 7 trip-out current ((+) positive polarity)
$I_d (-)$	Step 8 trip-out current ((-) negative polarity)
$U_c$	Contact voltage for rated $I_{\Delta N}$

## 7.8 Z loop – Fault loop impedance and prospective fault current

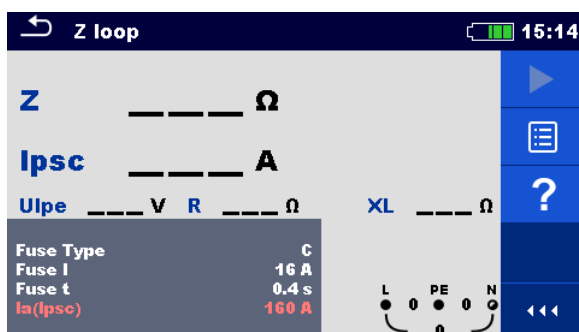

Figure 7.28: Z loop menu

### Measurement parameters / limits

<b>Fuse Type</b>	<b>Selection of fuse type [gG, NV, B, C, D, K]</b>
<b>Fuse I</b>	<b>Rated current of selected fuse</b>
<b>Fuse t</b>	<b>Maximum breaking time of selected fuse</b>
<b>Ia(Ipsc)</b>	<b>Minimum fault current for selected fuse</b>

See Appendix A for reference fuse data.

### Connection diagram

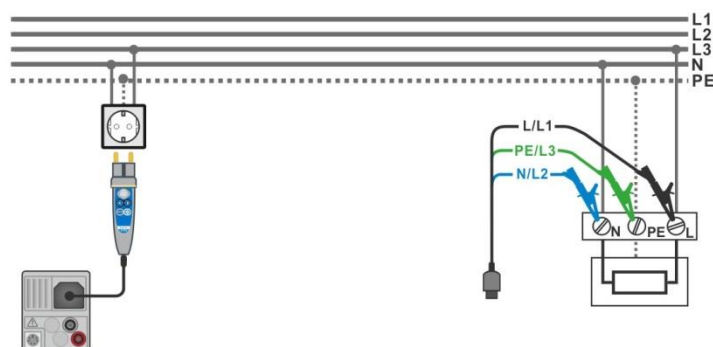

Figure 7.29: Connection of Plug commander and 3-wire test lead

### Measurement procedure

- Enter the **Z loop** function.
- Set test parameters / limits.
- Connect test cable to the instrument.
- Connect test leads or Plug commander to the object under test, see **Figure 7.29**.
- Start the measurement.
- Save results (optional).

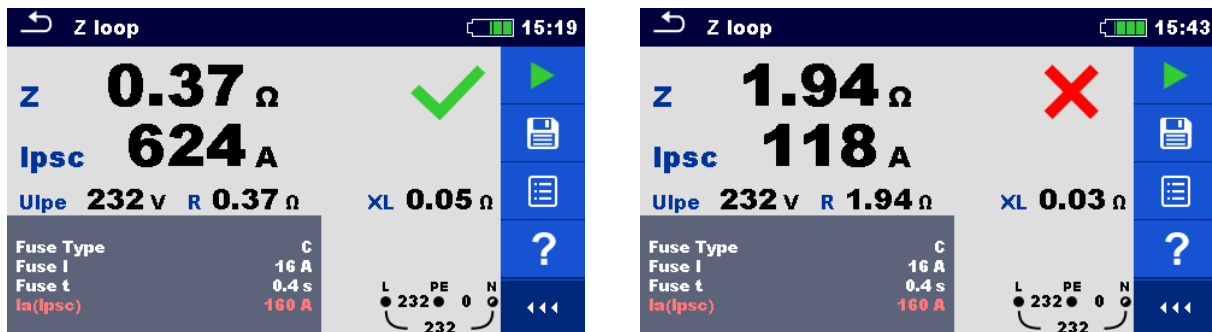

Figure 7.30: Examples of Loop impedance measurement result

### Measurement results / sub-results

<b>Z</b>	Loop impedance
<b>Ipsc</b>	Prospective fault current
<b>Ulpe</b>	Voltage L-PE
<b>R</b>	Resistance of loop impedance
<b>XL</b>	Reactance of loop impedance

Prospective fault current  $I_{PSC}$  is calculated from measured impedance as follows:

$$I_{PSC} = \frac{U_N \times k_{SC}}{Z}$$

where:

$U_N$  ..... Nominal  $U_{L-PE}$  voltage (see table below),

$k_{SC}$  ..... Correction factor (Isc factor) for  $I_{PSC}$  (see chapter **4.6.4 Settings**).

$U_N$	Input voltage range (L-PE)
110 V	$(93 \text{ V} \leq U_{L-PE} \leq 134 \text{ V})$
230 V	$(185 \text{ V} \leq U_{L-PE} \leq 266 \text{ V})$

## 7.9 Zs rcd – Fault loop impedance and prospective fault current in system with RCD

Zs rcd measurement prevents trip-out of the RCD in systems with the RCD.

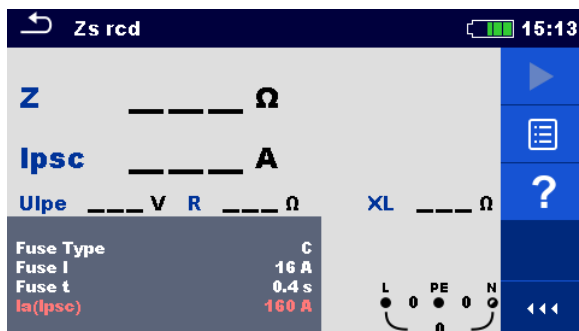

Figure 7.31: Zs rcd menu

### Measurement parameters / limits

<b>Fuse Type</b>	Selection of fuse type [gG, NV, B, C, D, K]
<b>Fuse I</b>	Rated current of selected fuse
<b>Fuse t</b>	Maximum breaking time of selected fuse
<b>Ia(Ipsc)</b>	Minimum fault current for selected fuse

See Appendix A for reference fuse data.

### Connection diagram

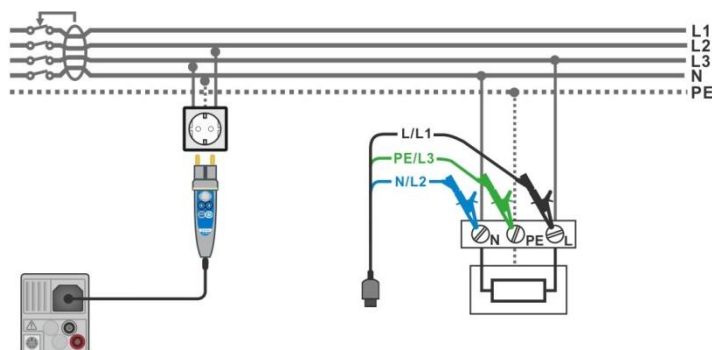

Figure 7.32: Connection of Plug commander and 3-wire test lead

**Measurement procedure**

- › Enter the **Zs rcd** function.
- › Set test parameters / limits.
- › Connect test cable to the instrument.
- › Connect test leads or Plug commander to the object under test, see **Figure 7.32**.
- › Start the measurement.
- › Save results (optional).

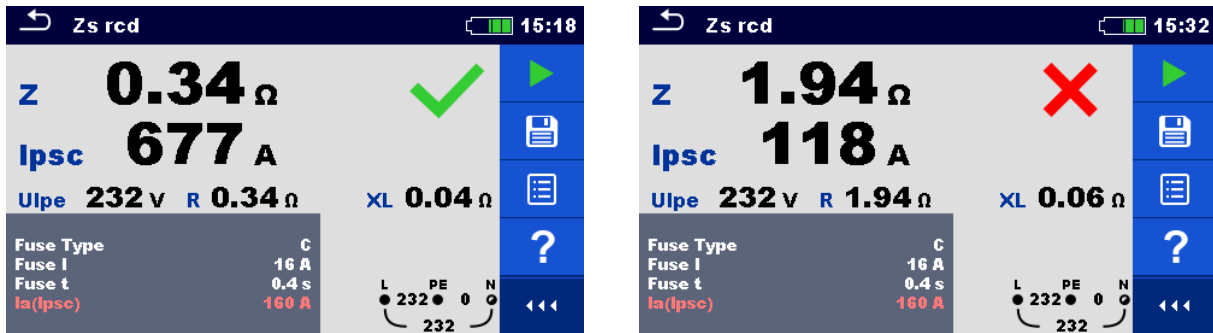

Figure 7.33: Examples of Zs rcd measurement result

**Measurement results / sub-results**

<b>Z</b>	Loop impedance
<b>Ipsc</b>	Prospective fault current
<b>Ulpe</b>	Voltage L-PE
<b>R</b>	Resistance of loop impedance
<b>XL</b>	Reactance of loop impedance

Prospective fault current  $I_{PSC}$  is calculated from measured impedance as follows:

$$I_{PSC} = \frac{U_N \times k_{SC}}{Z}$$

where:

$U_N$ .....Nominal  $U_{L-PE}$  voltage (see table below),

$k_{SC}$  .....Correction factor (Isc factor) for  $I_{PSC}$  (see chapter **4.6.4 Settings**).

<b><math>U_n</math></b>	<b>Input voltage range (L-PE)</b>
110 V	$(93 \text{ V} \leq U_{L-PE} \leq 134 \text{ V})$
230 V	$(185 \text{ V} \leq U_{L-PE} \leq 266 \text{ V})$



## 7.10 Z loop mΩ – High precision fault loop impedance and prospective fault current

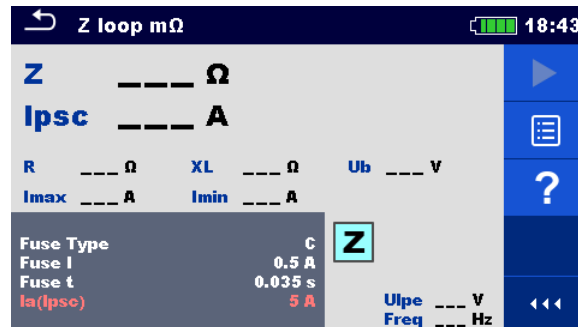

Figure 7.34: Z loop mΩ menu

### Measurement parameters / limits

<b>Fuse Type</b>	Selection of fuse type [gG, NV, B, C, D, K]
<b>Fuse I</b>	Rated current of selected fuse
<b>Fuse t</b>	Maximum breaking time of selected fuse
<b>Ia(Ipsc)</b>	Minimum fault current for selected fuse

See Appendix A for reference fuse data.

### Connection diagram

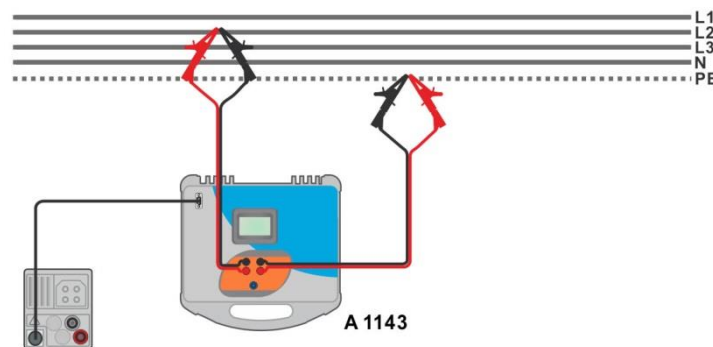

Figure 7.35: High precision Loop impedance measurement – Connection of A 1143

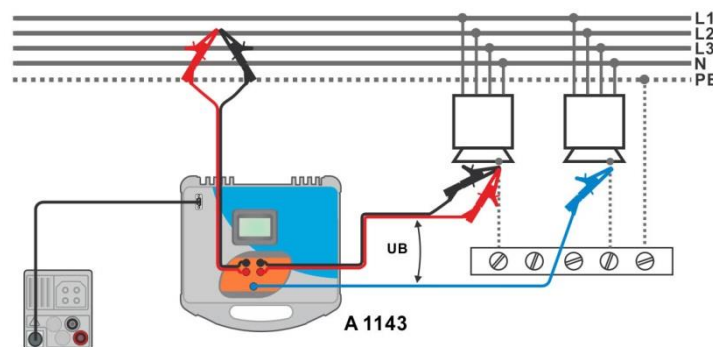



Figure 7.36: Contact voltage measurement – Connection of A 1143

## Measurement procedure

- › Enter the **Z loop mΩ** function.
- › Set test parameters / limits.
- › Connect test leads to A 1143 – Euro Z 290 A adapter and switch it on.
- › Connect A 1143 – Euro Z 290 A adapter to the instrument using RS232-PS/2 cable.
- › Connect test leads to the object under test, see **Figure 7.35** and **Figure 7.36**.
- › Start the measurement using  or  button.
- › Save results (optional).

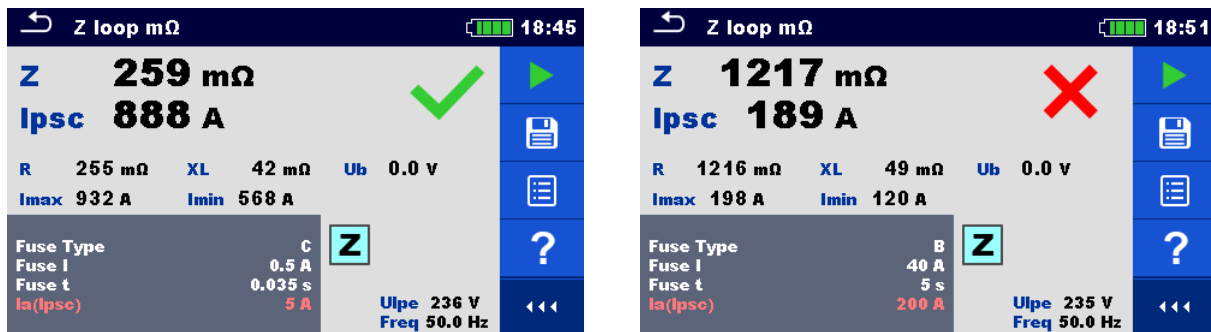

Figure 7.37: Examples of high precision Loop impedance measurement result

## Measurement results / sub-results

<b>Z</b>	Loop impedance
<b>Ipsc</b>	Standard prospective fault current
<b>I<sub>max</sub></b>	Maximal prospective fault current
<b>I<sub>min</sub></b>	Minimal prospective fault current
<b>U<sub>b</sub></b>	Contact voltage at maximal prospective fault current (contact voltage measured against Probe S if used)
<b>R</b>	Resistance of loop impedance
<b>XL</b>	Reactance of loop impedance
<b>Ulpe</b>	Voltage L-PE
<b>Freq</b>	Frequency

Standard prospective fault current  $I_{PSC}$  is calculated as follows:

$$I_{PSC} = \frac{230 V}{Z} \quad \text{where} \quad U_{L-PE} = 230 V \pm 10 \%$$

The prospective fault currents  $I_{Min}$  and  $I_{Max}$  are calculated as follows:

$$I_{Min} = \frac{C_{min} U_{N(L-PE)}}{Z_{(L-PE)hot}} \quad \text{where} \quad Z_{(L-PE)hot} = \sqrt{(1.5R_{L-PE})^2 + X_{L-PE}^2}$$

$$C_{min} = \begin{cases} 0.95; & U_{N(L-PE)} = 230 V \pm 10 \% \\ 1.00; & \text{otherwise} \end{cases}$$

and

$$I_{Max} = \frac{C_{max} U_{N(L-PE)}}{Z_{L-PE}} \quad \text{where} \quad Z_{L-PE} = \sqrt{R_{L-PE}^2 + X_{L-PE}^2}$$

$$C_{max} = \begin{cases} 1.05; & U_{N(L-PE)} = 230 V \pm 10 \% \\ 1.10; & \text{otherwise} \end{cases}$$

Refer to **A 1143 – Euro Z 290 A adapter Instruction manual** for detailed information.

## 7.11 Z line – Line impedance and prospective short-circuit current

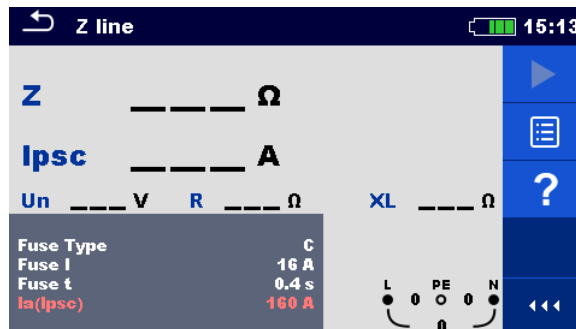

Figure 7.38: Z line measurement menu

### Measurement parameters / limits

Fuse Type	Selection of fuse type [gG, NV, B, C, D, K]
Fuse I	Rated current of selected fuse
Fuse t	Maximum breaking time of selected fuse
Ia(Ipsc)	Minimum short-circuit current for selected fuse

See Appendix A for reference fuse data.

### Connection diagram

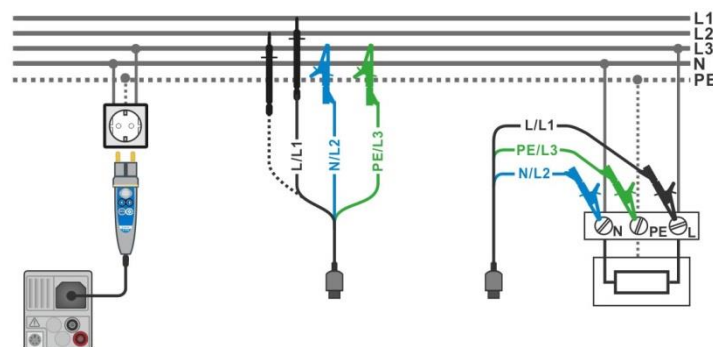

Figure 7.39: Phase-neutral or phase-phase line impedance measurement – connection of Plug commander and 3-wire test lead

### Measurement procedure

- › Enter the **Z line** function.
- › Set test parameters / limits.
- › Connect test cable to the instrument.
- › Connect test leads or Plug commander to the object under test, see **Figure 7.39**.
- › Start the measurement.
- › Save results (optional).

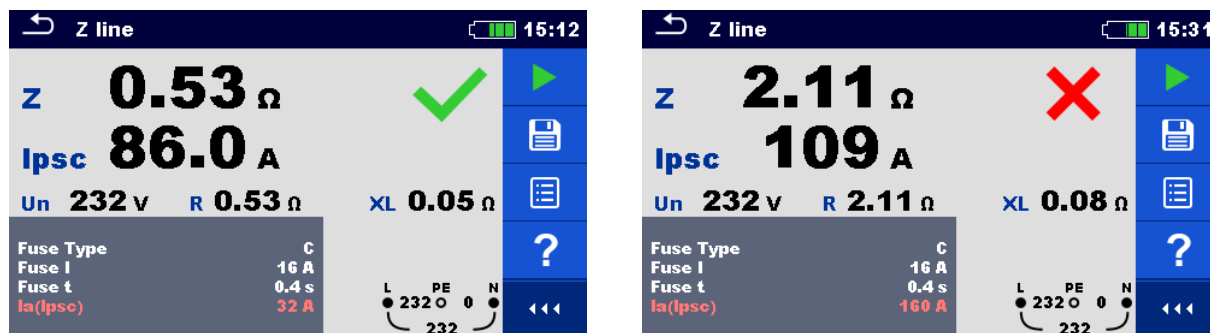

Figure 7.40: Examples of Line impedance measurement result

**Measurement results / sub-results**

<b>Z</b>	Line impedance
<b>IpSC</b>	Prospective short-circuit current
<b>Un</b>	Voltage L-N
<b>R</b>	Resistance of line impedance
<b>XL</b>	Reactance of line impedance

Prospective short circuit current  $I_{PSC}$  is calculated as follows:

$$I_{PSC} = \frac{U_N \times k_{SC}}{Z}$$

where:

$U_N$ .....Nominal  $U_{L-N}$  or  $U_{L-L}$  voltage (see table below),

$k_{SC}$  .....Correction factor (Isc factor) for  $I_{PSC}$  (see chapter **4.6.4 Settings**).

<b><math>U_n</math></b>	<b>Input voltage range (L-N or L-L)</b>
110 V	$(93\text{ V} \leq U_{L-N} \leq 134\text{ V})$
230 V	$(185\text{ V} \leq U_{L-N} \leq 266\text{ V})$
400 V	$(321\text{ V} \leq U_{L-L} \leq 485\text{ V})$

## 7.12 Z line mΩ – High precision line impedance and prospective short-circuit current

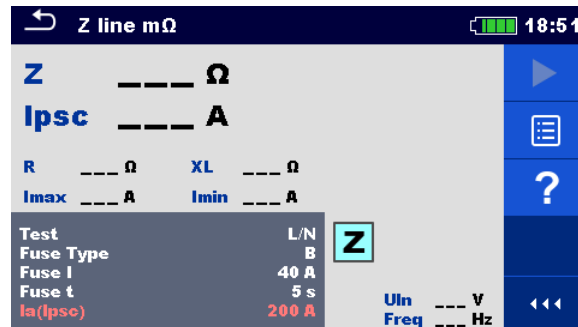

Figure 7.41: Z line mΩ menu

### Measurement parameters / limits

Test	Type of test [L/N, L/L]
Fuse Type	Selection of fuse type [gG, NV, B, C, D, K]
Fuse I	Rated current of selected fuse
Fuse t	Maximum breaking time of selected fuse
Ia(Ipsc)	Minimum short circuit current for selected fuse

See Appendix A for reference fuse data.

### Connection diagram

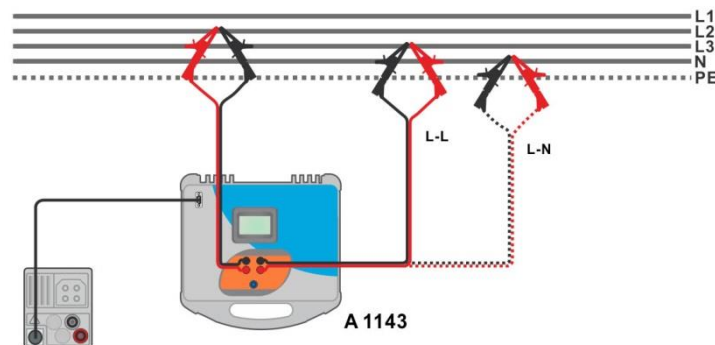



Figure 7.42: Phase-neutral or phase-phase high precision Line impedance measurement – Connection of A 1143

### Measurement procedure

- › Enter the **Z line mΩ** function.
- › Set test parameters / limits.
- › Connect test leads to A 1143 – Euro Z 290 A adapter and switch it on.
- › Connect A 1143 – Euro Z 290 A adapter to the instrument using RS232-PS/2 cable.
- › Connect test leads to the object under test, see **Figure 7.42**.

- › Start the measurement using  or  button.
- › Save results (optional).

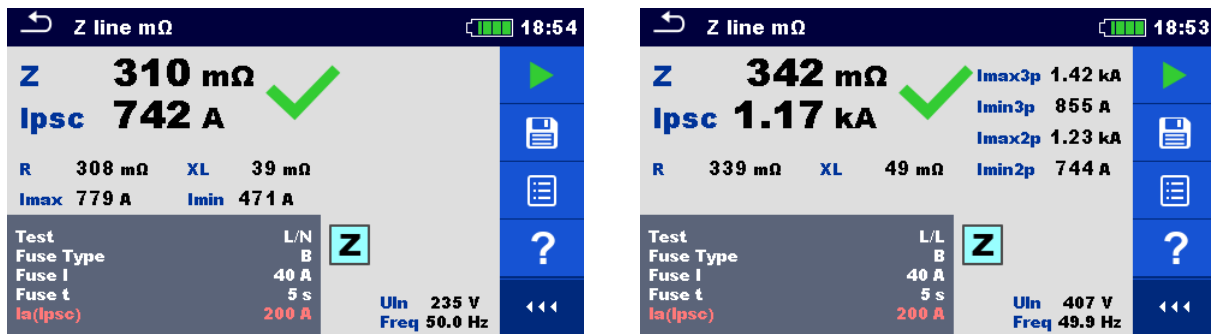

Figure 7.43: Examples of high precision Line impedance measurement result

### Measurement results / sub-results

<b>Z</b>	Line impedance
<b>Ipsc</b>	Standard prospective short-circuit current
<b>Imax</b>	Maximal prospective short-circuit current
<b>Imin</b>	Minimal prospective short-circuit current
<b>Imax2p</b>	Maximal two-phases prospective short-circuit current
<b>Imin2p</b>	Minimal two-phases prospective short-circuit current
<b>Imax3p</b>	Maximal three-phases prospective short-circuit current
<b>Imin3p</b>	Minimal three-phases prospective short-circuit current
<b>R</b>	Resistance of line impedance
<b>XL</b>	Reactance of line impedance
<b>Uln</b>	Voltage L-N or L-L
<b>Freq</b>	Frequency

Standard prospective short-circuit current  $I_{PSC}$  is calculated as follows:

$$I_{PSC} = \frac{230 V}{Z} \quad \text{where} \quad U_{L-N} = 230 V \pm 10 \%$$

$$I_{PSC} = \frac{400 V}{Z} \quad \text{where} \quad U_{L-L} = 400 V \pm 10 \%$$

The prospective short-circuit currents  $I_{Min}$ ,  $I_{Min2p}$ ,  $I_{Min3p}$  and  $I_{Max}$ ,  $I_{Max2p}$ ,  $I_{Max3p}$  are calculated as follows:

$I_{Min} = \frac{C_{min} U_{N(L-N)}}{Z_{(L-N)hot}}$	where	$Z_{(L-N)hot} = \sqrt{(1.5 \times R_{(L-N)})^2 + X_{(L-N)}^2}$ $C_{min} = \begin{cases} 0.95; & U_{N(L-N)} = 230 V \pm 10 \% \\ 1.00; & \text{otherwise} \end{cases}$
---	-------	--

$I_{Max} = \frac{C_{max} U_{N(L-N)}}{Z_{(L-N)}}$	where	$Z_{(L-N)} = \sqrt{R_{(L-N)}^2 + X_{(L-N)}^2}$ $C_{max} = \begin{cases} 1.05; & U_{N(L-N)} = 230 V \pm 10 \% \\ 1.10; & \text{otherwise} \end{cases}$
--	-------	--

$I_{Min2p} = \frac{C_{min} U_{N(L-L)}}{Z_{(L-L)hot}}$	where	$Z_{(L-L)hot} = \sqrt{(1.5 \times R_{(L-L)})^2 + X_{(L-L)}^2}$ $C_{min} = \begin{cases} 0.95; & U_{N(L-L)} = 400 V \pm 10 \% \\ 1.00; & otherwise \end{cases}$
$I_{Max2p} = \frac{C_{max} U_{N(L-L)}}{Z_{(L-L)}}$	where	$Z_{(L-L)} = \sqrt{R_{(L-L)}^2 + X_{(L-L)}^2}$ $C_{max} = \begin{cases} 1.05; & U_{N(L-L)} = 400 V \pm 10 \% \\ 1.10; & otherwise \end{cases}$
$I_{Min3p} = \frac{C_{min} \times U_{N(L-L)}}{\sqrt{3}} \frac{2}{Z_{(L-L)hot}}$	where	$Z_{(L-L)hot} = \sqrt{(1.5 \times R_{(L-L)})^2 + X_{(L-L)}^2}$ $C_{min} = \begin{cases} 0.95; & U_{N(L-L)} = 400 V \pm 10 \% \\ 1.00; & otherwise \end{cases}$
$I_{Max3p} = \frac{C_{max} \times U_{N(L-L)}}{\sqrt{3}} \frac{2}{Z_{(L-L)}}$	where	$Z_{(L-L)} = \sqrt{R_{(L-L)}^2 + X_{(L-L)}^2}$ $C_{max} = \begin{cases} 1.05; & U_{N(L-L)} = 400 V \pm 10 \% \\ 1.10; & otherwise \end{cases}$

Refer to **A 1143 – Euro Z 290 A adapter Instruction manual** for detailed information.

## 7.13 Voltage Drop

The voltage drop is calculated based on the difference of line impedance at connection points (sockets) and the line impedance at the reference point (usually the impedance at the switchboard).

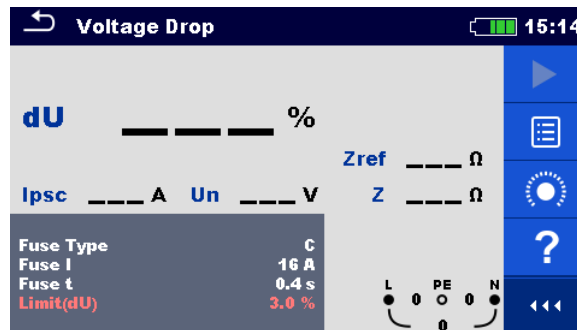

Figure 7.44: Voltage drop menu

### Measurement parameters / limits

<b>Fuse Type</b>	Selection of fuse type [gG, NV, B, C, D, K]
<b>Fuse I</b>	Rated current of selected fuse
<b>Fuse t</b>	Maximum breaking time of selected fuse
<b>Limit(dU)</b>	Maximum voltage drop [3.0 % ... 9.0 %]

See Appendix A for reference fuse data.

### Connection diagram

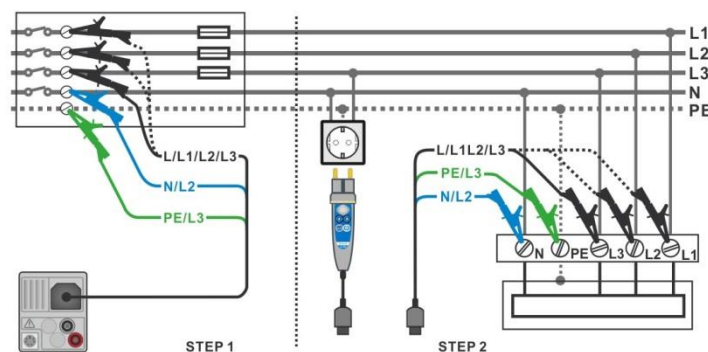



Figure 7.45: Voltage drop measurement – connection of Plug commander and 3-wire test lead

### Measurement procedure

#### STEP 1: Measuring the impedance $Z_{ref}$ at origin

- › Enter the **Voltage Drop** function.
- › Set test parameters / limits.
- › Connect test cable to the instrument.
- › Connect test leads to the origin of electrical installation, see **Figure 7.45**.
- › Touch or select the  icon to initiate  $Z_{ref}$  measurement.



- › Press the  button to measure Zref.

## STEP 2: Measuring the Voltage drop

- › Enter the **Voltage Drop** function.
- › Set test parameters / limits.
- › Connect test cable to the instrument.
- › Connect test leads or Plug commander to the tested points, see **Figure 7.45**.
- › Start the measurement.
- › Save results (optional).

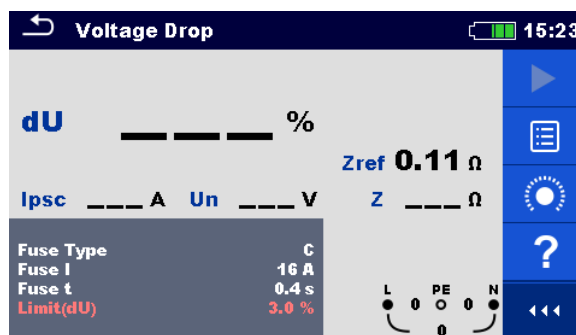

Figure 7.46: Example of Zref measurement result (STEP 1)

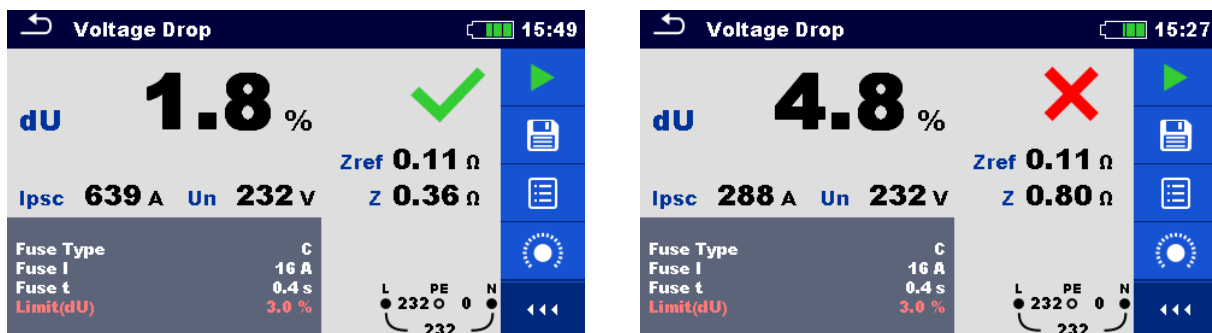

Figure 7.47: Examples of Voltage drop measurement result (STEP 2)

## Measurement results / sub-results

<b>dU</b>	Voltage drop
<b>Ip<sub>sc</sub></b>	Prospective short-circuit current
<b>Un</b>	Voltage L-N
<b>Zref</b>	Reference line impedance
<b>Z</b>	Line impedance

Voltage drop is calculated as follows:

$$dU[\%] = \frac{(Z - Z_{REF}) \cdot I_N}{U_N} \cdot 100$$

where:

<b>dU</b>	Calculated Voltage drop
<b>Zref</b>	Impedance at reference point (at origin)
<b>Z</b>	Impedance at test point
<b>U<sub>n</sub></b>	Nominal voltage
<b>I<sub>n</sub></b>	Rated current of selected fuse (Fuse I)

<b>U<sub>n</sub></b>	<b>Input voltage range (L-N or L-L)</b>
110 V	$(93 \text{ V} \leq U_{L-N} \leq 134 \text{ V})$
230 V	$(185 \text{ V} \leq U_{L-N} \leq 266 \text{ V})$
400 V	$(321 \text{ V} \leq U_{L-L} \leq 485 \text{ V})$

## 7.14 Earth – Earth resistance (3-wire test)

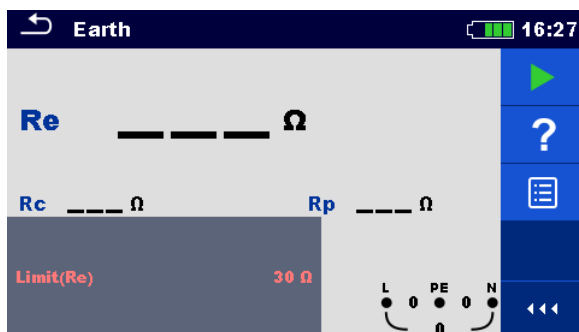

Figure 7.48: Earth menu

### Measurement parameters / limits

Limit(Re) Maximum resistance [Off, 1 Ω ... 5 kΩ]

### Connection diagrams

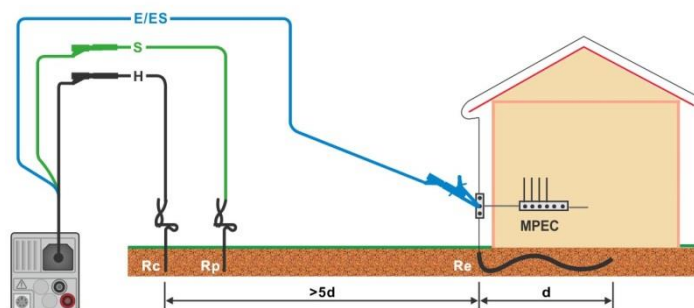

Figure 7.49: Resistance to earth, measurement of main installation earthing

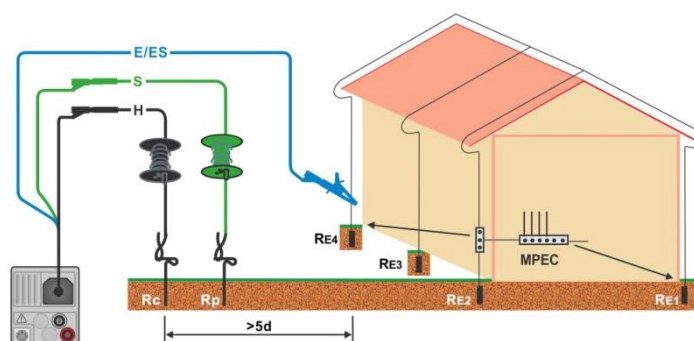

Figure 7.50: Resistance to earth, measurement of a lighting protection system

### Measurement procedure

- › Enter the **Earth** function.
- › Set test parameters / limits.
- › Connect test cable to the instrument.
- › Connect test leads to the object under test, see **Figure 7.49** and **Figure 7.50**.

- 
- Start the measurement.
  - Save results (optional).
- 

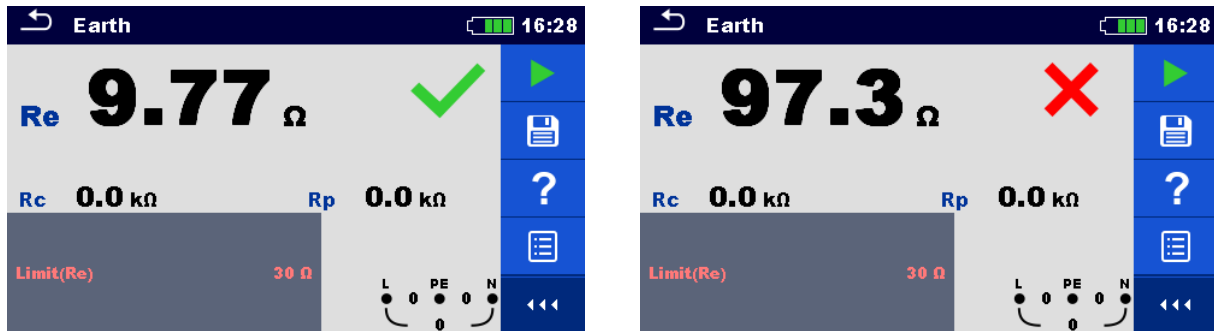

Figure 7.51: Examples of Earth resistance measurement result

### Measurement results / sub-results

<b>Re</b>	Earth resistance
<b>Rc</b>	Resistance of H (current) probe
<b>Rp</b>	Resistance of S (potential) probe

## 7.15 Earth 2 clamp – Contactless earthing resistance measurement (with two current clamps)

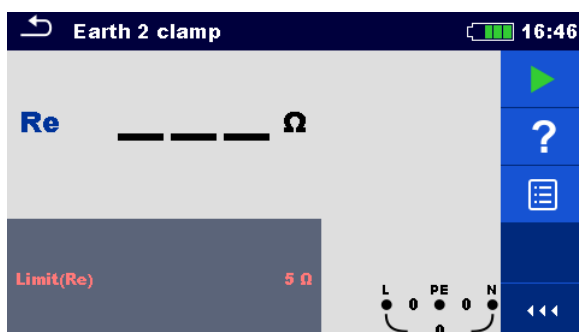

Figure 7.52: Earth 2 clamps menu

### Measurement parameters / limits

Limit(Re) Maximum resistance [Off, 1 Ω ... 30 Ω]

### Connection diagram

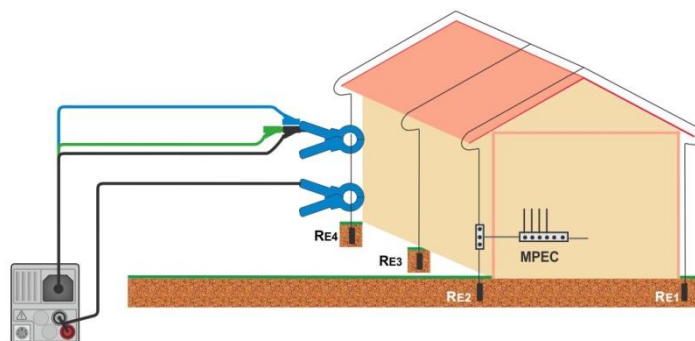

Figure 7.53: Contactless earthing resistance measurement

### Measurement procedure

- › Enter the **Earth 2 clamp** function.
- › Set test parameters / limits.
- › Connect test cable and clamps to the instrument.
- › Clamp on object under test, see **Figure 7.53**.
- › Start the measurement.
- › Stop the measurement.
- › Save results (optional).

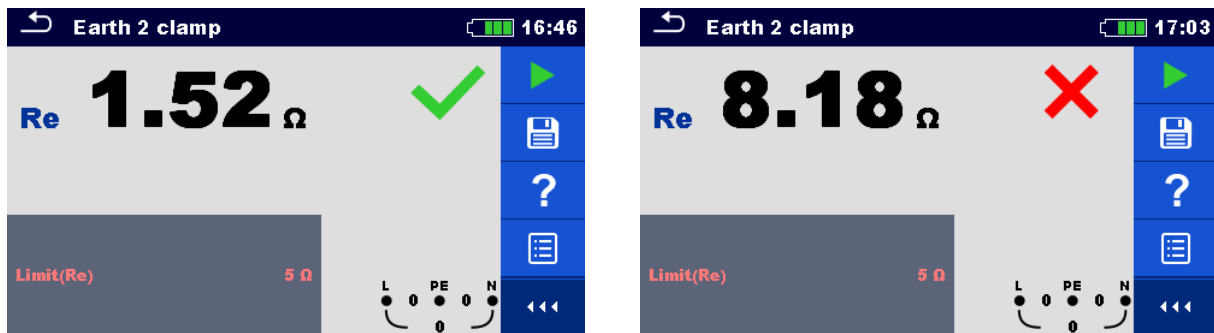

Figure 7.54: Examples of Contactless earthing resistance measurement result

### Measurement results / sub-results

Re	Earth resistance
----	------------------

## 7.16 Ro – Specific earth resistance

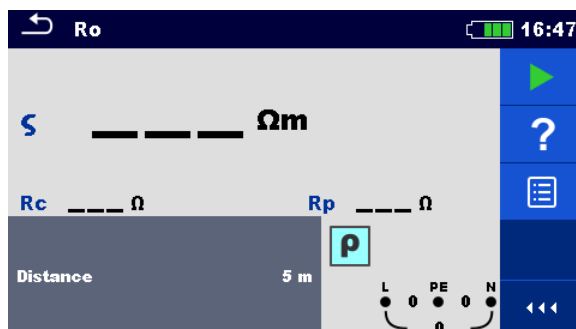

Figure 7.55: Earth Ro menu

### Measurement parameters / limits

Distance	Distance between probes [0.1 m ... 30.0 m] or [1 ft ... 100 ft]
----------	---

### Connection diagram

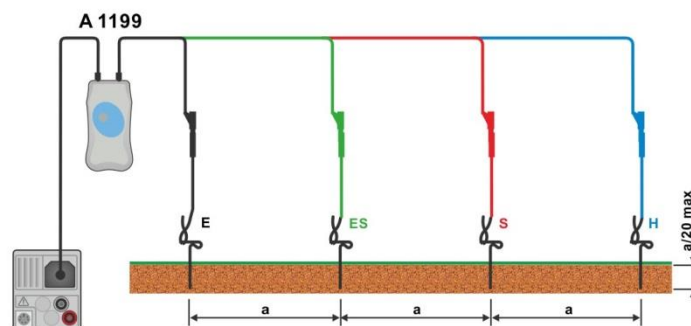

Figure 7.56: Specific earth resistance measurement

### Measurement procedure

- › Enter the **Ro** function.
- › Set test parameters / limits.
- › Connect A 1199 adapter to the instrument.
- › Connect test leads to earth probes, see **Figure 7.56**.
- › Start the measurement.
- › Save results (optional).

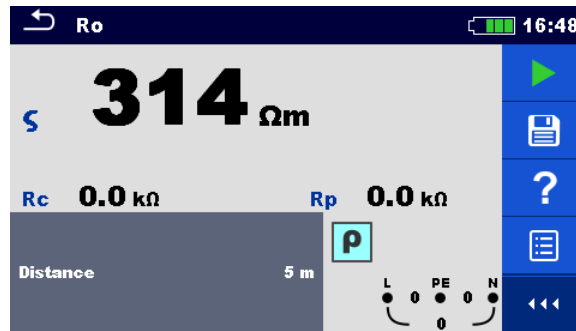

Figure 7.57: Example of Specific earth resistance measurement result

### Measurement results / sub-results

$\rho$	Specific earth resistance
<b>Rc</b>	Resistance of H, E (current) probe
<b>Rp</b>	Resistance of S, ES (potential) probe



## 7.17 Power

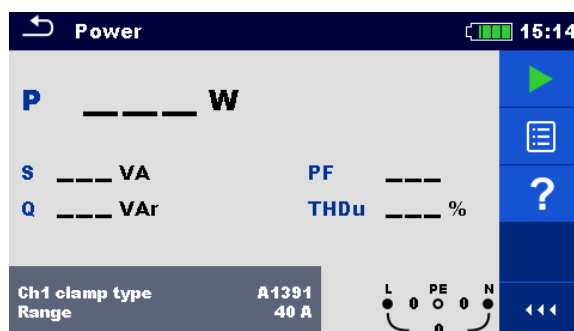

Figure 7.58: Power menu

### Measurement parameters / limits

Ch1 clamp type	Current clamp adapter [A1018, A1019, A1391]
Range	Range for selected current clamp adapter
	A1018 [20 A]
	A1019 [20 A]
	A1391 [40 A, 300 A]

### Connection diagram

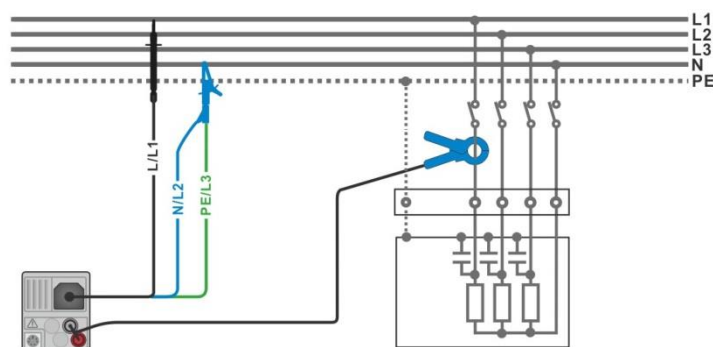

Figure 7.59: Power measurement

### Measurement procedure

- › Enter the **Power** function.
- › Set parameters / limits.
- › Connect the voltage test leads and current clamp to the instrument.
- › Connect the voltage test leads and current clamp to the item to be tested (see **Figure 7.59**).
- › Start the continuous measurement.
- › Stop the measurement.
- › Save results (optional).

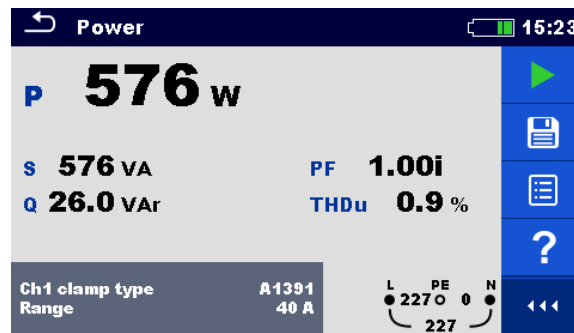

Figure 7.60: Example of Power measurement result

### Measurement results / sub-results

<b>P</b>	Active power
<b>S</b>	Apparent power
<b>Q</b>	Reactive power (capacitive or inductive)
<b>PF</b>	Power factor (capacitive or inductive)
<b>THDu</b>	Voltage total harmonic distortion

## 7.18 Harmonics

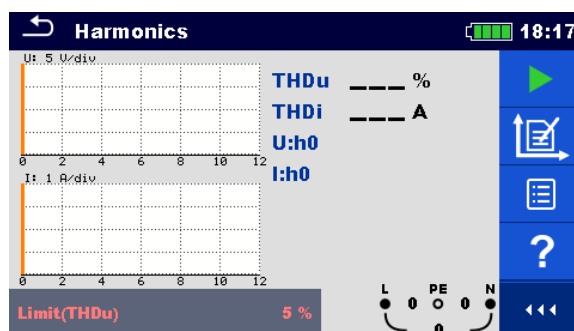

Figure 7.61: Harmonics menu

### Measurement parameters / limits

<b>Ch1 clamp type</b>	<b>Current clamp adapter [A1018, A1019, A1391]</b>
<b>Range</b>	<b>Range for selected current clamp adapter</b> A1018 [20 A] A1019 [20 A] A1391 [40 A, 300 A]
<b>Limit(THDu)</b>	<b>Max. THD of voltage [3 % ... 10 %]</b>

### Connection diagram

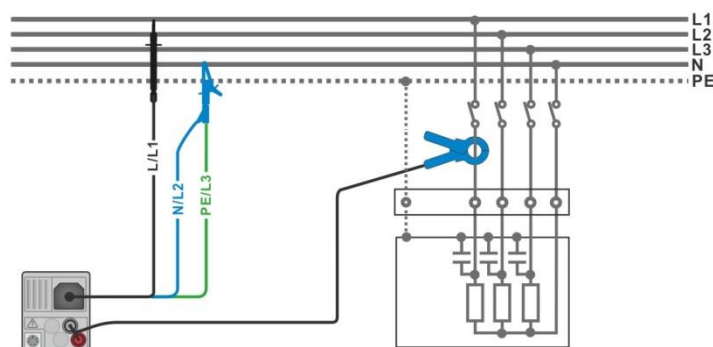

Figure 7.62: Harmonics measurement

### Measurement procedure

- › Enter the **Harmonics** function.
- › Set parameters / limits.
- › Connect voltage test leads and current clamp to the instrument.
- › Connect the voltage test leads and current clamp to the item to be tested, see **Figure 7.62**.
- › Start the continuous measurement.
- › Stop the measurement.
- › Save results (optional).

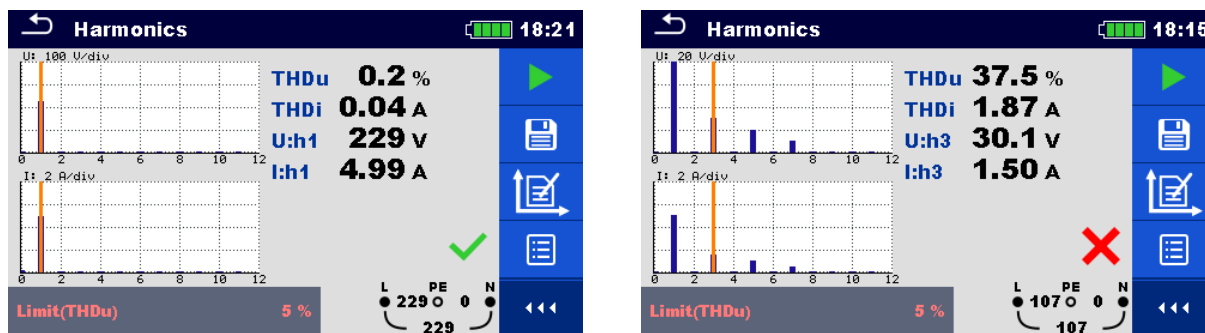

Figure 7.63: Examples of Harmonics measurement results

**Measurement results / sub-results**

<b>U:h(i)</b>	TRMS voltage of selected harmonic [h0 ... h12]
<b>I:h(i)</b>	TRMS current of selected harmonic [h0 ... h12]
<b>THDu</b>	Voltage total harmonic distortion
<b>THDi</b>	Current total harmonic distortion

## 7.19 Currents

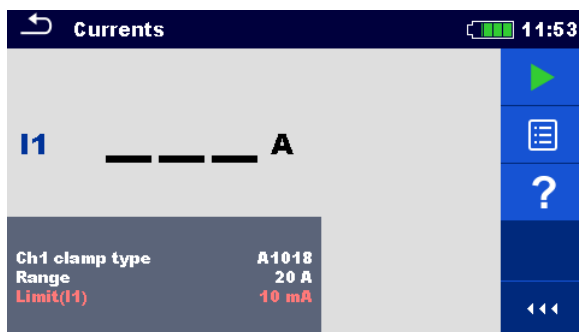

Figure 7.64: Current menu

### Measurement parameters / limits

<b>Ch1 clamp type</b>	<b>Current clamp adapter [A1018, A1019, A1391]</b>
<b>Range</b>	<b>Range for selected current clamp adapter</b> A1018 [20 A] A1019 [20 A] A1391 [40 A, 300 A]
<b>Limit(I1)</b>	<b>Max. differential leakage [Off, 0.1 mA ... 100 mA]</b>

### Connection diagram

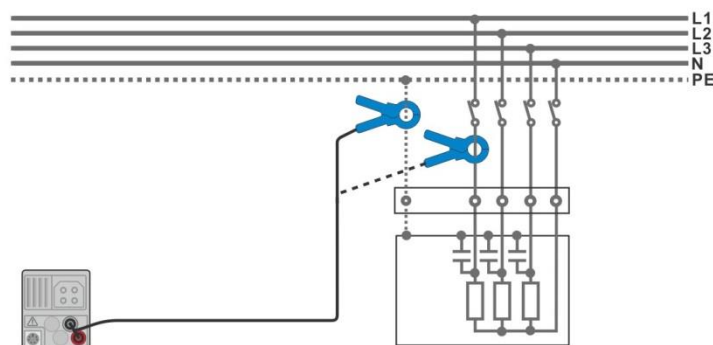

Figure 7.65: Leakage and load current measurements

### Measurement procedure

- › Enter the **Currents** function.
- › Set parameters / limits.
- › Connect the current clamp to the instrument.
- › Connect the clamp to the object under test, see **Figure 7.65**.
- › Start the continuous measurement.
- › Stop the measurement.
- › Save results (optional).

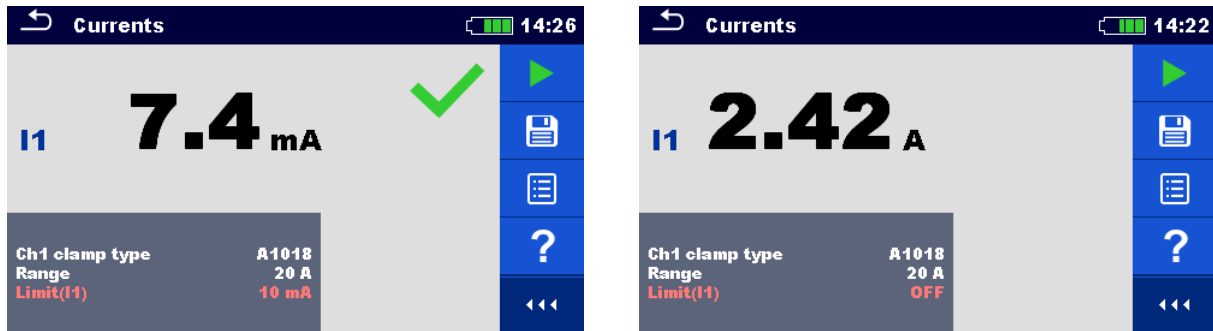

Figure 7.66: Examples of Current measurement result

### Measurement results / sub-results

I1 Leakage or load current

## 7.20 ISFL – First fault leakage current (MI 3152 only)

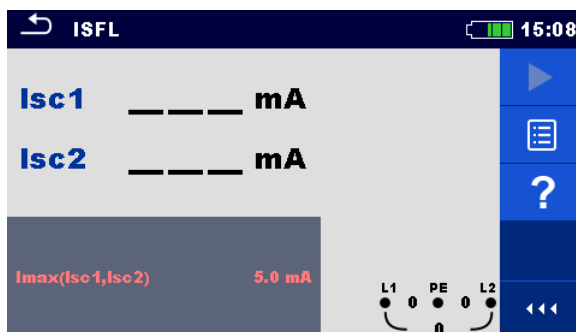

Figure 7.67: ISFL measurement menu

### Measurement parameters / limits

**Imax(Isc1, Isc2)** Maximum first fault leakage current [Off, 3.0 mA ... 19.5 mA]

### Connection diagrams

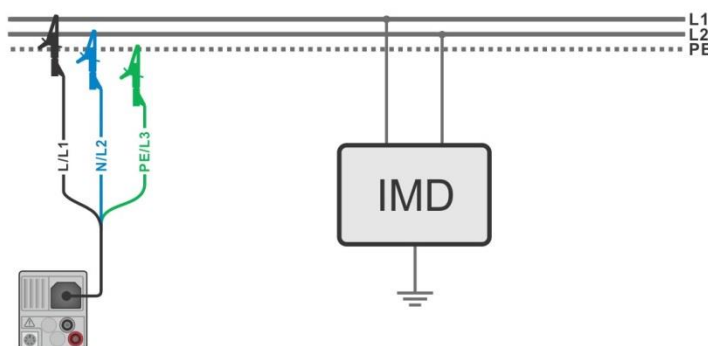

Figure 7.68: Measurement of highest First fault leakage current with 3-wire test lead

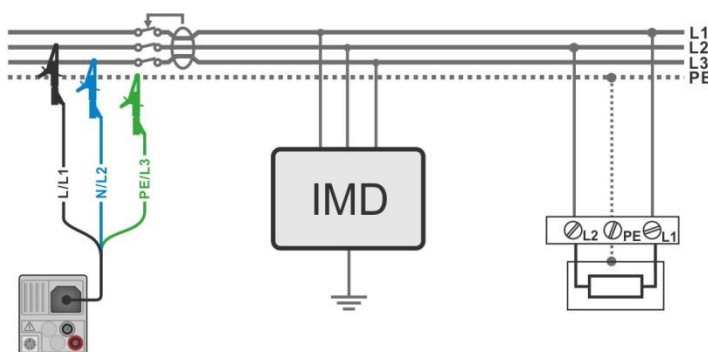

Figure 7.69: Measurement of First fault leakage current for RCD protected circuit with 3-wire test lead

### Measurement procedure

- ▶ Enter the **ISFL** function.
- ▶ Set test parameters / limits.
- ▶ Connect test cable to the instrument.

- › Connect test leads to the object under test, see **Figure 7.68** and **Figure 7.69**.
- › Start the measurement.
- › Save results (optional).



Figure 7.70: Examples of First fault leakage current measurement result

### Measurement results / sub-results

<b>I<sub>sc1</sub></b>	First fault leakage current at single fault between L1/PE
<b>I<sub>sc2</sub></b>	First fault leakage current at single fault between L2/PE



## 7.21 IMD – Testing of insulation monitoring devices (MI 3152 only)

This function checks the alarm threshold of insulation monitor devices (IMD) by applying a changeable resistance between L1/PE and L2/PE terminals.

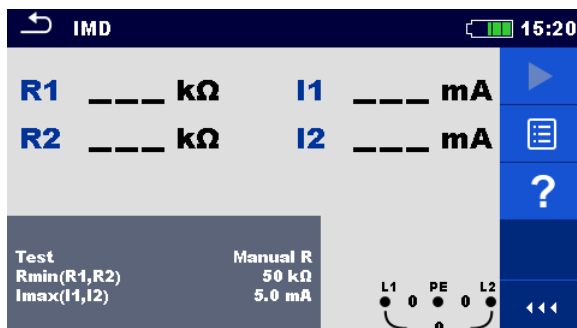

Figure 7.71: IMD test menu

### Test parameters / limits

Test	Test mode [MANUAL R, MANUAL I, AUTO R, AUTO I]
t step	Timer (AUTO R and AUTO I test modes) [1 s ... 99 s]
Rmin(R1,R2)	Min. insulation resistance [Off, 5 kΩ ... 640 kΩ],
Imax(I1,I2)	Max. fault current [Off, 0.1 mA ... 19.9 mA]

### Connection diagram

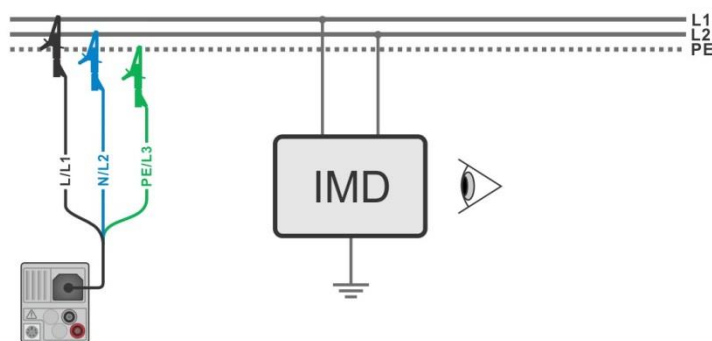











Figure 7.72: Connection with 3-wire test lead



**Test procedure (MANUAL R, MANUAL I)**

- › Enter the **IMD** function.
- › Set test parameter to MANUAL R or MANUAL I.  
Set other test parameters / limits.
- › Connect test cable to the instrument.
- › Connect test leads to the object under test, see **Figure 7.72**.
- › Start the measurement.



- › Use the   or   keys to change insulation resistance<sup>\*)</sup> until IMD alarms an insulation failure for L1.

- › Press  or the  key to change line terminal selection to L2.  
(If IMD switches off voltage supply, instrument automatically changes line terminal selection to L2 and proceeds with the test when supply voltage is detected.)

- › Use the   or   keys to change insulation resistance<sup>\*)</sup> until IMD alarms an insulation failure for L2.





- › Press the  or the  key.  
(If IMD switches off voltage supply, instrument automatically proceeds to the PASS / FAIL / NO STATUS indication.)



- › Use  to select PASS / FAIL / NO STATUS indication.

- › Press  or the  key to confirm selection and complete the measurement.
- › Save results (optional).

**Test procedure (AUTO R, AUTO I)**

- › Enter the **IMD** function.
- › Set test parameter to AUTO R or AUTO I.
- › Set other test parameters / limits.
- › Connect test cable to the instrument.
- › Connect test leads to the object under test, see **Figure 7.72**.
- › Start the measurement.  
Insulation resistance between L1-PE is decreased automatically according to limit value<sup>\*)</sup> every time interval selected with timer. To speed up the test press the



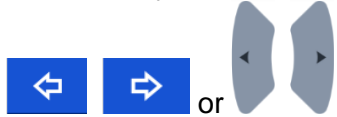

  or   keys until IMD alarms an insulation failure for L1.

- › Press  or the  key to change line terminal selection to L2.  
(If IMD switches off voltage supply, instrument automatically changes line terminal selection to L2 and proceeds with the test when supply voltage is detected.)
- › Insulation resistance between L2-PE is decreased automatically according to limit

value<sup>\*)</sup> every time interval selected with timer. To speed up the test press the



keys until IMD alarms an insulation failure for L2.

- ▶ Press the  or the  key.  
If IMD switches off voltage supply, instrument automatically proceeds to the PASS / FAIL / NO STATUS indication.
- ▶ Use  to select PASS / FAIL / NO STATUS indication.
- ▶ Press  or the  key to confirm selection and complete the measurement.
- ▶ Save results (optional).

- <sup>\*)</sup> When MANUAL R or AUTO R sub-function is selected, starting value of insulation resistance is determined by  $R_{START} \cong 1.5 \times R_{LIMIT}$ .  
When MANUAL I or AUTO I sub-function is selected, starting value of insulation resistance is determined by  $R_{START} \cong 1.5 \times \frac{U_{L1-L2}}{I_{LIMIT}}$

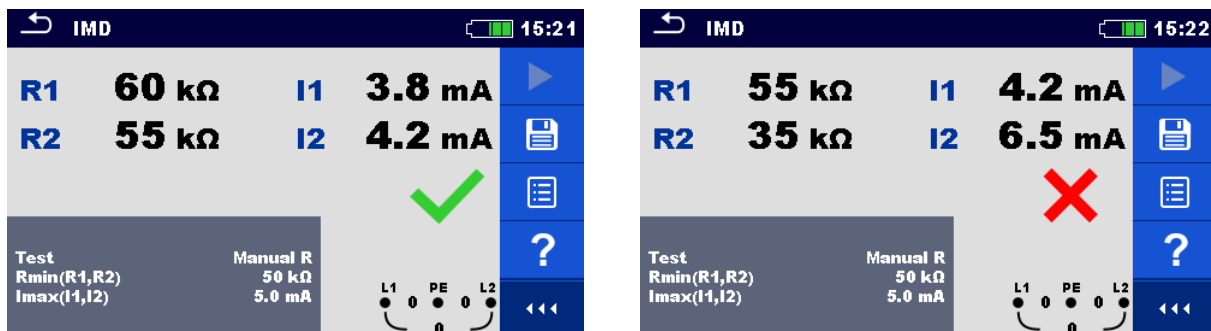

Figure 7.73: Examples of IMD test result

### Test results / sub-results

<b>R1</b>	Threshold insulation resistance between L1-PE
<b>I1</b>	Calculated first fault leakage current for R1
<b>R2</b>	Threshold insulation resistance between L2-PE
<b>I2</b>	Calculated first fault leakage current for R2

Calculated first fault leakage current at threshold insulation resistance is given as  $I_{1(2)} = \frac{U_{L1-L2}}{R_{1(2)}}$ , where  $U_{L1-L2}$  is line-line voltage. The calculated first fault current is the maximum current that would flow when insulation resistance decreases to the same value as the applied test resistance, and a first fault is assumed between opposite line and PE.

## 7.22 Rpe – PE conductor resistance



Figure 7.74: PE conductor resistance measurement menu

### Measurement parameters / limits

<b>Bonding</b>	[Rpe,Local]
<b>RCD</b>	[Yes, No]
<b>Limit(Rpe)</b>	<b>Max. resistance</b> [Off, 0.1 Ω ... 20.0 Ω]

### Connection diagram

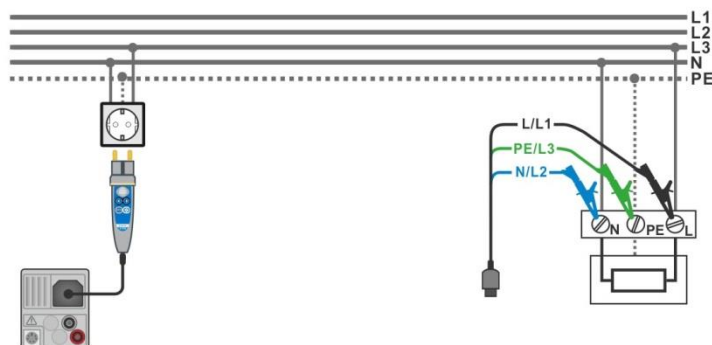

Figure 7.75: Connection of Plug commander and 3-wire test lead

## Measurement procedure

- › Enter the **Rpe** function.
- › Set test parameters / limits.
- › Connect test cable to the instrument.
- › Connect test leads or Plug commander to the object under test, see **Figure 7.75**.
- › Start the measurement.
- › Save results (optional).

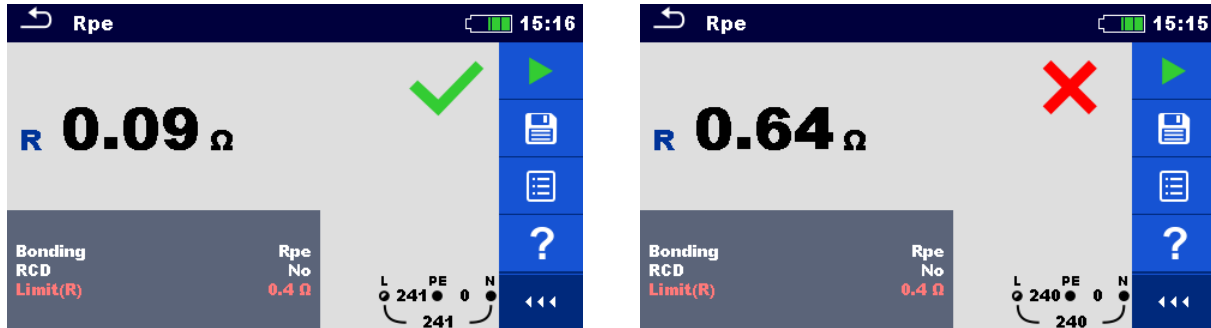

Figure 7.76: Examples of PE conductor resistance measurement result

## Measurement results / sub-results

**Rpe** PE conductor resistance

## 7.23 Illumination

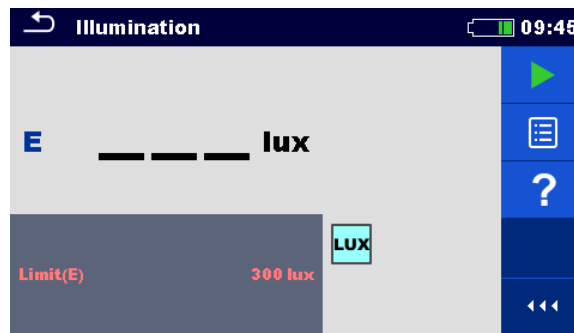

Figure 7.77: Illumination measurement menu

### Measurement parameters / limits

**Limit(E) Minimum illumination** [Off, 0.1 lux ... 20 klux]

### Probe positioning

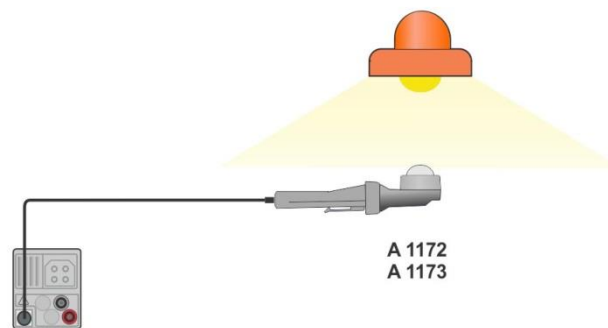

Figure 7.78: LUXmeter probe positioning

### Measurement procedure

- › Enter the **Illumination** function.
- › Set test parameters / limits.
- › Connect illumination sensor A 1172 or A 1173 to the instrument.
- › Take the position of LUXmeter probe, see **Figure 7.78**.  
Make sure that LUXmeter probe is turned on.
- › Start the continuous measurement.
- › Stop the measurement.
- › Save results (optional).



Figure 7.79: Examples of Illumination measurement result

### Measurement results / sub-results

E Illumination

## 8 Auto tests

Auto tests perform automatic executing of pre-defined measurement sequences. The following Auto Tests are available:

- › AUTO TT,
- › AUTO TN (RCD),
- › AUTO TN and
- › AUTO IT (MI 3152 only).

Auto test can be selected in the main **Auto Tests** menu or from **Memory organizer** by touching



button or pressing the  key from any selected structure object.

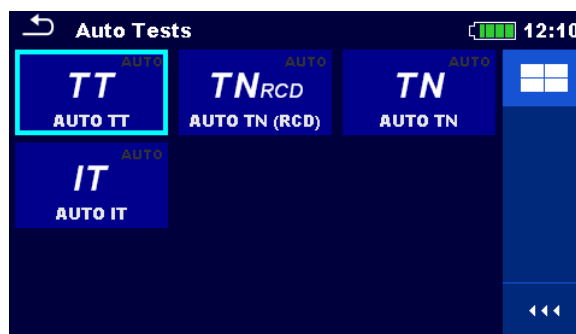

Figure 8.1: Auto Tests menu

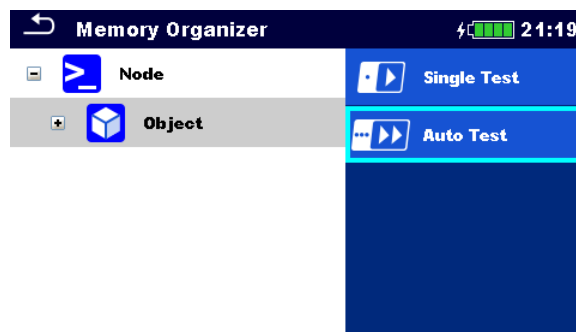

Figure 8.2: Auto Test selection from Memory organizer

Use chapter **6 Single tests** as a reference on Auto test screen organization and as guidance how to set parameters and limits.



## 8.1 AUTO TT – Auto test sequence for TT earthing system

Tests / measurements implemented in AUTO TT sequence

Voltage
Z line
Voltage Drop
Zs rcd
RCD Uc

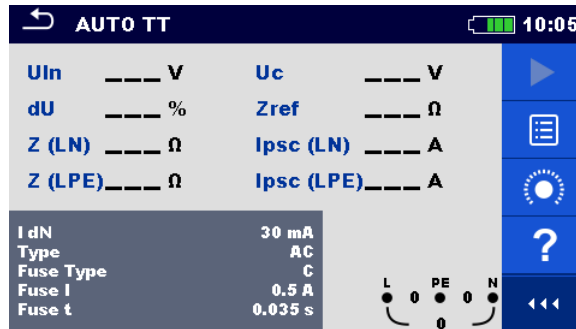

Figure 8.3: AUTO TT menu

### Measurement parameters / limits

<b>I dN</b>	<b>Rated RCD residual current sensitivity</b> [10 mA, 30 mA, 100 mA, 300 mA, 500 mA, 1000 mA]
<b>Type</b>	<b>RCD type</b> [AC, A, F, B*, B+*]
<b>Selectivity</b>	<b>Characteristic</b> [G, S]
<b>Fuse type</b>	<b>Selection of fuse type</b> [gG, NV, B, C, D, K]
<b>Fuse I</b>	<b>Rated current of selected fuse</b>
<b>Fuse t</b>	<b>Maximum breaking time of selected fuse</b>
<b>Limit(dU)</b>	<b>Maximum voltage drop</b> [3.0 % ... 9.0 %]
<b>Limit Uc(Uc)</b>	<b>Conventional touch voltage limit</b> [25 V, 50 V]
<b>Ia(IpSC (LN), IpSC (LPE))</b>	<b>Minimum short circuit current for selected fuse</b>

See Appendix A for reference fuse data.

\* Model MI 3152 only.

### Connection diagram

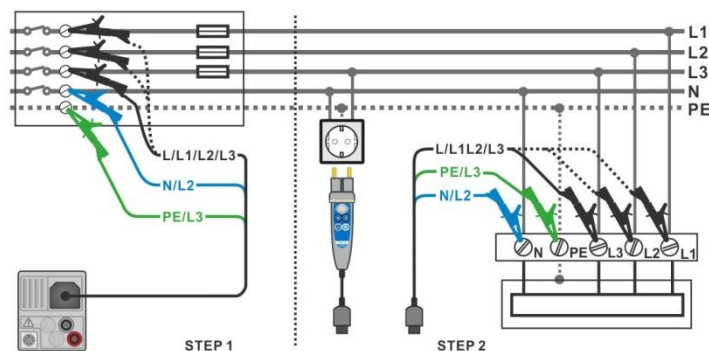

Figure 8.4: AUTO TT measurement

### Measurement procedure

- › Enter the **AUTO TT** function.
- › Set test parameters / limits.
- › Measure the impedance  $Z_{ref}$  at origin (optional), see chapter **7.13 Voltage Drop**.
- › Connect test cable to the instrument.
- › Connect test leads or Plug commander to the object under test, see **Figure 8.4**.
- › Start the Auto test.
- › Save results (optional).

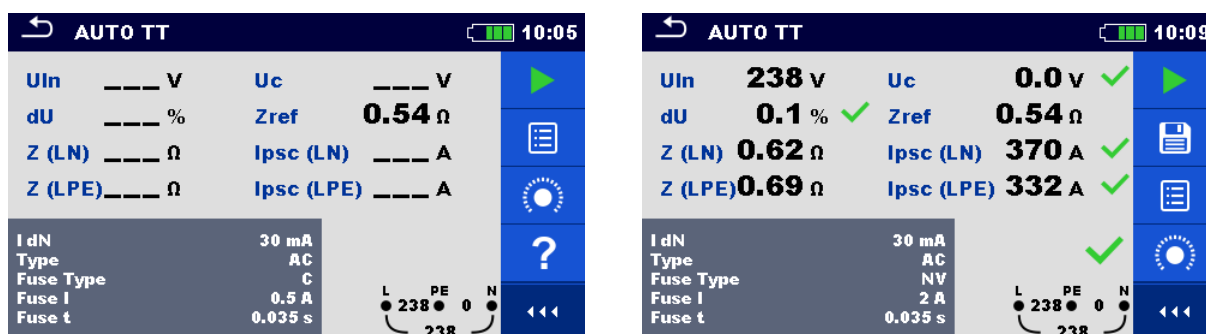

Figure 8.5: Examples of AUTO TT measurement results

### Measurement results / sub-results

<b><math>U_{In}</math></b>	Voltage between phase and neutral conductors
<b><math>dU</math></b>	Voltage drop
<b><math>Z(LN)</math></b>	Line impedance
<b><math>Z(LPE)</math></b>	Loop impedance
<b><math>U_c</math></b>	Contact voltage
<b><math>Z_{ref}</math></b>	Reference Line impedance
<b><math>I_{psc}(LN)</math></b>	Prospective short-circuit current
<b><math>I_{psc}(LPE)</math></b>	Prospective fault current

## 8.2 AUTO TN (RCD) – Auto test sequence for TN earthing system with RCD

Tests / measurements implemented in AUTO TN (RCD) sequence

Voltage
Z line
Voltage Drop
Zs rcd
Rpe rcd

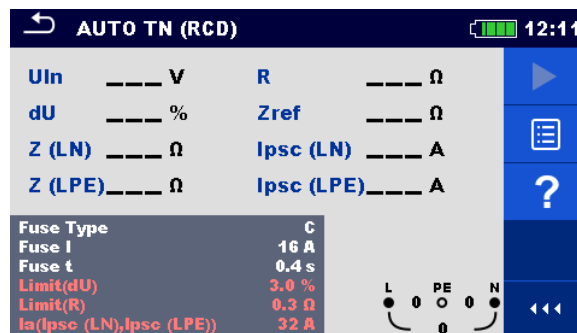

Figure 8.6: AUTO TN (RCD) menu

Measurement parameters / limits

<b>Fuse type</b>	<b>Selection of fuse type [gG, NV, B, C, D, K]</b>
<b>Fuse I</b>	<b>Rated current of selected fuse</b>
<b>Fuse t</b>	<b>Maximum breaking time of selected fuse</b>
<b>Limit(dU)</b>	<b>Maximum voltage drop [3.0 % ... 9.0 %]</b>
<b>Limit (Rpe)</b>	<b>Max. resistance [Off, 0.1 Ω ... 20.0 Ω]</b>
<b>Ia(Ipsc (LN), Ipsc (LPE))</b>	<b>Minimum short circuit current for selected fuse</b>

See Appendix A for reference fuse data.

Connection diagram

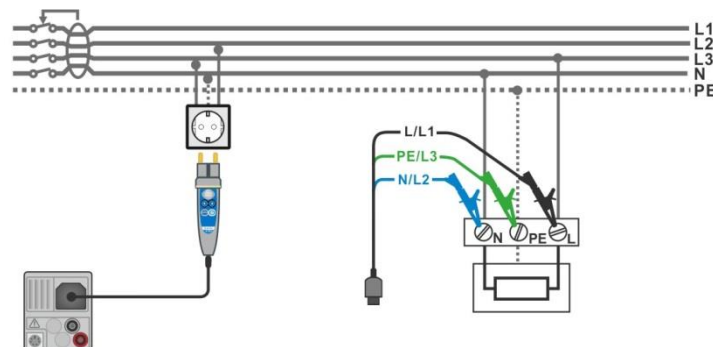

Figure 8.7: AUTO TN (RCD) measurement

## Measurement procedure

- › Enter the **AUTO TN (RCD)** function.
- › Set test parameters / limits.
- › Measure the impedance Zref at origin (optional), see chapter **7.13 Voltage Drop**.
- › Connect test cable to the instrument.
- › Connect test leads or Plug commander to the object under test, see **Figure 8.7**.
- › Start the Auto test.
- › Save results (optional).



Figure 8.8: Examples of AUTO TN (RCD) measurement results

## Measurement results / sub-results

<b>UIn</b>	Voltage between phase and neutral conductors
<b>dU</b>	Voltage drop
<b>Z (LN)</b>	Line impedance
<b>Z (LPE)</b>	Loop impedance
<b>Rpe</b>	PE conductor resistance
<b>Zref</b>	Reference Line impedance
<b>Ipsc (LN)</b>	Prospective short-circuit current
<b>Ipsc (LPE)</b>	Prospective fault current

### 8.3 AUTO TN – Auto test sequence for TN earthing system without RCD

Tests / measurements implemented in AUTO TN sequence

Voltage
Z line
Voltage Drop
Z loop
Rpe

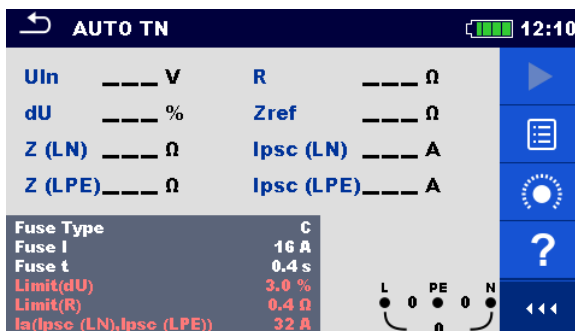

Figure 8.9: AUTO TN menu

Measurement parameters / limits

<b>Fuse type</b>	<b>Selection of fuse type [gG, NV, B, C, D, K]</b>
<b>Fuse I</b>	<b>Rated current of selected fuse</b>
<b>Fuse t</b>	<b>Maximum breaking time of selected fuse</b>
<b>Limit(dU)</b>	<b>Maximum voltage drop [3.0 % ... 9.0 %]</b>
<b>Limit(Rpe)</b>	<b>Max. resistance [Off, 0.1 Ω ... 20.0 Ω]</b>
<b>Ia(Ipsc (LN), Ipsc (LPE))</b>	<b>Minimum short circuit current for selected fuse</b>

See Appendix A for reference fuse data.

Connection diagram

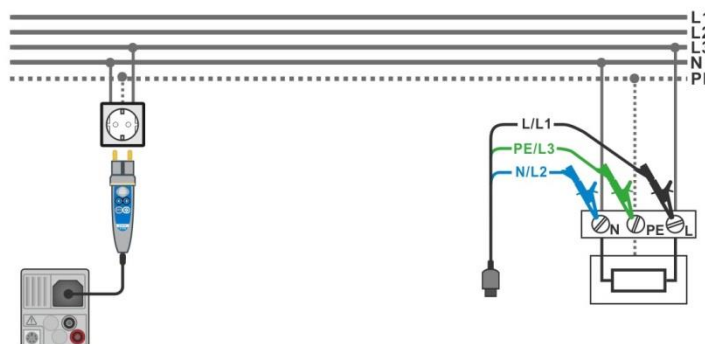

Figure 8.10: AUTO TN measurement

### Measurement procedure

- › Enter the **AUTO TN** function.
- › Set test parameters / limits.
- › Measure the impedance Zref at origin (optional), see chapter **7.13 Voltage Drop**.
- › Connect test cable to the instrument.
- › Connect test leads or Plug commander to the object under test, see **Figure 8.10**.
- › Start the Auto test.
- › Save results (optional).

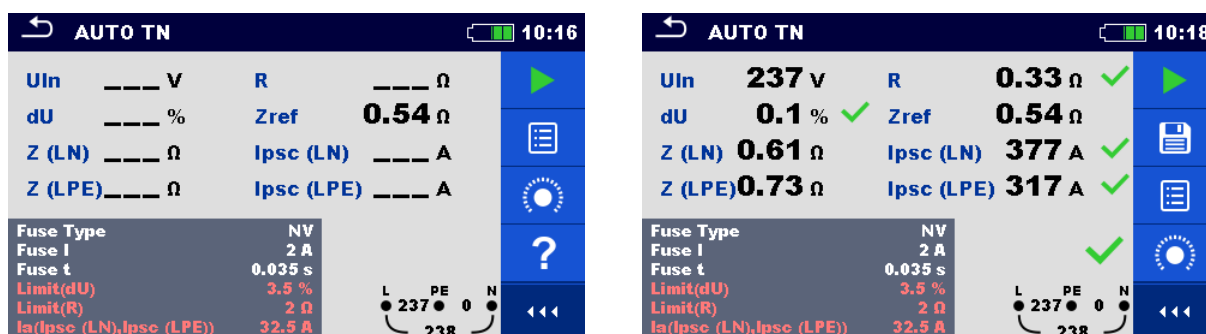

Figure 8.11: Examples of AUTO TN measurement results

### Measurement results / sub-results

<b>UIn</b>	Voltage between phase and neutral conductors
<b>dU</b>	Voltage drop
<b>Z (LN)</b>	Line impedance
<b>Z (LPE)</b>	Loop impedance
<b>Rpe</b>	PE conductor resistance
<b>Zref</b>	Reference Line impedance
<b>Ipsc (LN)</b>	Prospective short-circuit current
<b>Ipsc (LPE)</b>	Prospective fault current

## 8.4 AUTO IT – Auto test sequence for IT earthing system (MI 3152 only)

Tests / measurements implemented in AUTO IT sequence

Voltage
Z line
Voltage Drop
ISFL
IMD

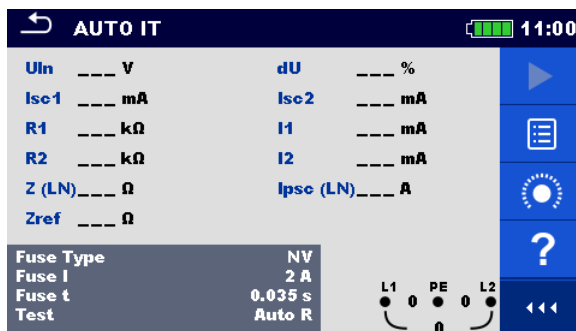

Figure 8.12: AUTO IT menu

Measurement parameters / limits

<b>Test</b>	<b>Test mode</b> [MANUAL R, MANUAL I, AUTO R, AUTO I]
<b>t step</b>	<b>Timer (AUTO R and AUTO I test modes)</b> [1 s ... 99 s]
<b>Fuse type</b>	<b>Selection of fuse type</b> [gG, NV, B, C, D, K]
<b>Fuse I</b>	<b>Rated current of selected fuse</b>
<b>Fuse t</b>	<b>Maximum breaking time of selected fuse</b>
<b>Limit(dU)</b>	<b>Maximum voltage drop</b> [3.0 % ... 9.0 %]
<b>Rmin(R1,R2)</b>	<b>Min. insulation resistance</b> [Off, 5 kΩ ... 640 kΩ],
<b>I<sub>max</sub>(I1,I2)</b>	<b>Max. fault current</b> [Off, 0.1 mA ... 19.9 mA]
<b>I<sub>max</sub>(Isc1,Isc2)</b>	<b>Maximum first fault leakage current</b> [Off, 3.0 mA ... 19.5 mA]
<b>I<sub>a</sub>(Ipsec (LN))</b>	<b>Minimum short circuit current for selected fuse</b>

See Appendix A for reference fuse data.

Connection diagram

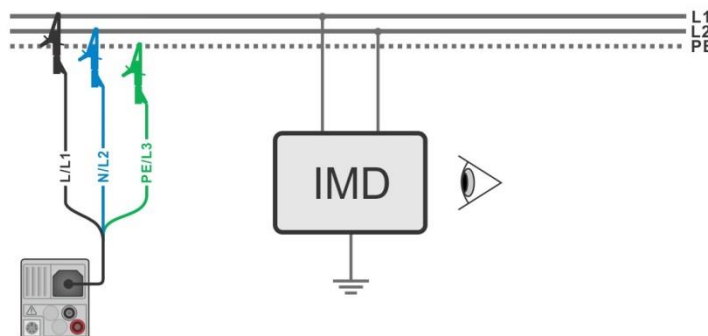

Figure 8.13: AUTO IT measurement

## Measurement procedure

- › Enter the **AUTO IT** function.
- › Set test parameters / limits.
- › Measure the impedance  $Z_{ref}$  at origin (optional), see chapter **7.13 Voltage Drop**.
- › Connect test cable to the instrument.
- › Connect test leads to the object under test, see **Figure 8.13**.
- › Start the Auto test.
- › Save results (optional).

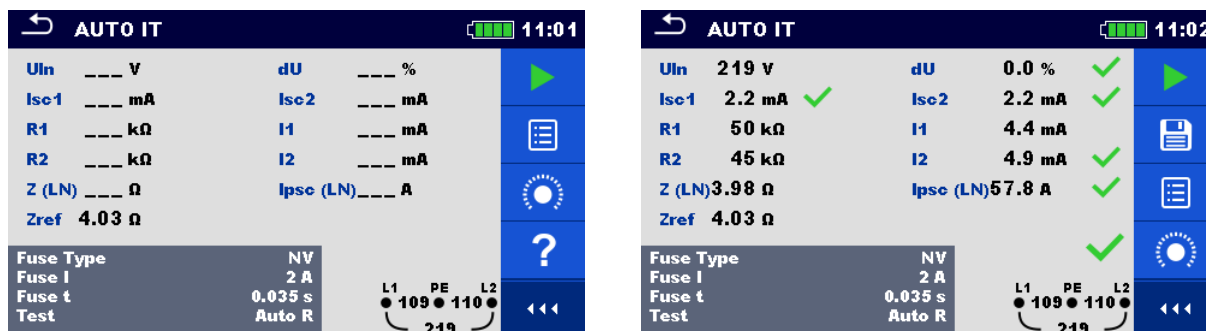

Figure 8.14: Examples of AUTO IT measurement results

## Measurement results / sub-results

<b>Uln</b>	Voltage between phases L1 and L2
<b>dU</b>	Voltage drop
<b>Isc1</b>	First fault leakage current at single fault between L1/PE
<b>Isc2</b>	First fault leakage current at single fault between L2/PE
<b>R1</b>	Threshold insulation resistance between L1-PE
<b>R2</b>	Threshold insulation resistance between L2-PE
<b>I1</b>	Calculated first fault leakage current for R1
<b>I2</b>	Calculated first fault leakage current for R2
<b>Z (LN)</b>	Line impedance
<b>Zref</b>	Reference Line impedance
<b>Ipsc (LN)</b>	Prospective short-circuit current



## 9 Communication

Tree structure and stored results from Memory Organizer can be transferred to a PC. A special communication program on the PC automatically identifies the instrument and enables data transfer between the instrument and the PC.

There are three communication interfaces available on the instrument: USB, RS 232 and Bluetooth.

### 9.1 USB and RS232 communication

The instrument automatically selects the communication mode according to detected interface. USB interface has priority.

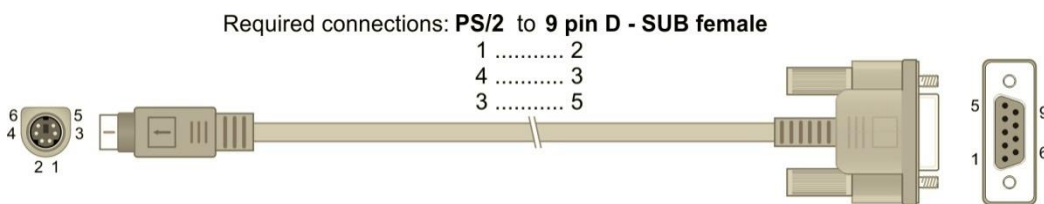

Figure 9.1: Interface connection for data transfer over PC COM port

#### How to establish an USB or RS-232 link:

- › RS-232 communication: connect a PC COM port to the instrument PS/2 connector using the PS/2 - RS232 serial communication cable;
- › USB communication: connect a PC USB port to the instrument USB connector using the USB interface cable.
- › Switch on the PC and the instrument.
- › Run the *Metrel ES Manager* software.
- › The PC and the instrument will automatically recognize each other.
- › The instrument is prepared to communicate with the PC.

Metrel ES Manager is a PC software running on Windows Vista, Windows 7, Windows 8 and Windows 8.1.

### 9.2 Bluetooth communication

The internal Bluetooth module enables easy communication via Bluetooth with PC and Android devices.

#### How to configure a Bluetooth link between instrument and PC

- › Switch On the instrument.
- › On PC configure a Standard Serial Port to enable communication over Bluetooth link between instrument and PC. Usually no code for pairing the devices is needed.
- › Run the *Metrel ES Manager* software.

- 
- › The PC and the instrument will automatically recognize each other.
  - › The instrument is prepared to communicate with the PC.
- 

#### **How to configure a Bluetooth link between instrument and Android device**

- 
- › Switch On the instrument.
  - › Some Android applications automatically carry out the setup of a Bluetooth connection. It is preferred to use this option if it exists. This option is supported by Metrel's Android applications.
  - › If this option is not supported by the selected Android application then configure a Bluetooth link via Android device's Bluetooth configuration tool. Usually no code for pairing the devices is needed.
  - › The instrument and Android device are ready to communicate.
- 

#### **Notes**

- › Sometimes there will be a demand from the PC or Android device to enter the code. Enter code 'NNNN' to correctly configure the Bluetooth link.
- › The name of correctly configured Bluetooth device must consist of the instrument type plus serial number, eg. *MI 3152-12240429I*. If the Bluetooth module got another name, the configuration must be repeated.
- › In case of serious troubles with the Bluetooth communication it is possible to reinitialize the internal Bluetooth module. The initialization is carried out during the Initial settings procedure. In case of a successful initialization "INITIALIZING... OK!" is displayed at the end of the procedure. See chapter **4.6.5 Initial Settings**.

## 10 Upgrading the instrument

The instrument can be upgraded from a PC via the RS232 or USB communication port. This enables to keep the instrument up to date even if the standards or regulations change. The firmware upgrade requires internet access and can be carried out from the **Metrel ES Manager** software with a help of special upgrading software – **FlashMe** which will guide you through the upgrading procedure. For more information refer to Metrel ES Manager Help file.

# 11 Maintenance

Unauthorized persons are not allowed to open the EurotestXC instrument. There are no user replaceable components inside the instrument, except the battery and fuses under back cover.

## 11.1 Fuse replacement

There are three fuses under back cover of the EurotestXC instrument.

<b>F1</b>	M 0.315 A / 250 V, 20×5 mm This fuse protects internal circuitry for continuity functions if test probes are connected to the mains supply voltage by mistake during measurement.
<b>F2, F3</b>	F 4 A / 500 V, 32×6.3 mm (breaking capacity: 50 kA) General input protection fuses of test terminals L/L1 and N/L2.

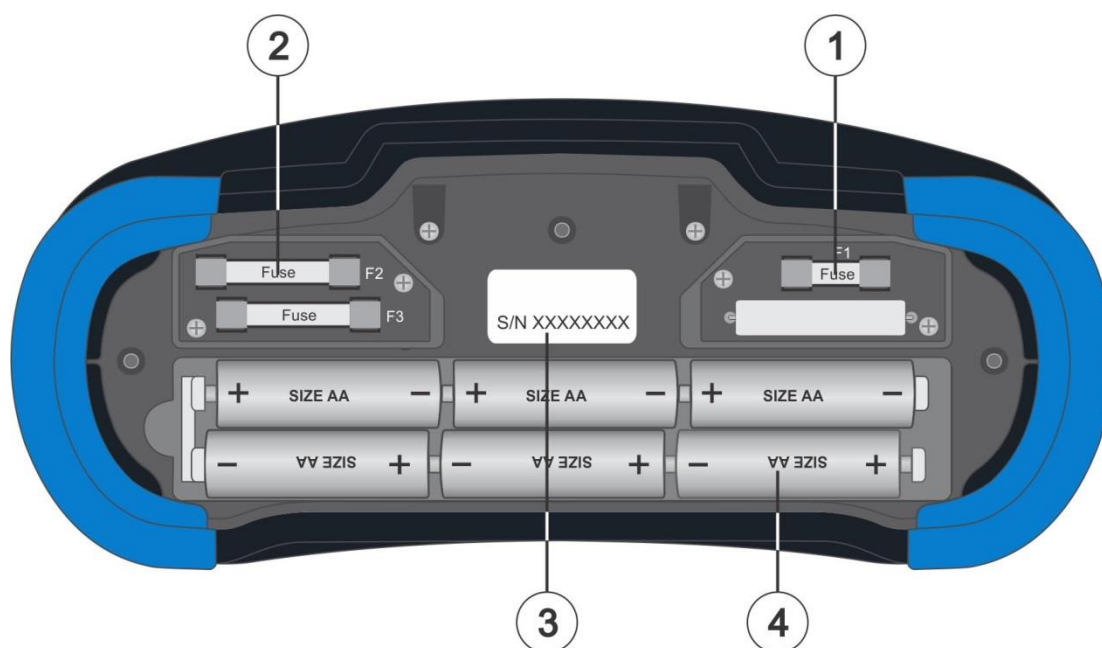

Figure 11.1: Fuses

### Warnings:

- › Disconnect all measuring accessory and switch off the instrument before opening battery / fuse compartment cover, hazardous voltage inside!
- › Replace blown fuse with original type only, otherwise the instrument or accessory may be damaged and / or operator's safety impaired!

## 11.2 Cleaning

No special maintenance is required for the housing. To clean the surface of the instrument or accessory use a soft cloth slightly moistened with soapy water or alcohol. Then leave the instrument or accessory to dry totally before use.

**Warnings:**

- › Do not use liquids based on petrol or hydrocarbons!
- › Do not spill cleaning liquid over the instrument!

## 11.3 Periodic calibration

It is essential that the test instrument is regularly calibrated in order that the technical specification listed in this manual is guaranteed. We recommend an annual calibration. Only an authorized technical person can do the calibration. Please contact your dealer for further information.

## 11.4 Service

For repairs under warranty, or at any other time, please contact your distributor.

## 12 Technical specifications

### 12.1 R iso – Insulation resistance

**Uiso: 50 V, 100 V and 250 V**

**Riso – Insulation resistance**

Measuring range according to EN 61557 is 0.15 M $\Omega$  ... 199.9 M $\Omega$ .

Measuring range (M $\Omega$ )	Resolution (M $\Omega$ )	Accuracy
0.00 ... 19.99	0.01	$\pm(5\%$ of reading + 3 digits)
20.0 ... 99.9	0.1	$\pm(10\%$ of reading)
100.0 ... 199.9		$\pm(20\%$ of reading)

**Uiso: 500 V and 1000 V**

**Riso – Insulation resistance**

Measuring range according to EN 61557 is 0.15 M $\Omega$  ... 999 M $\Omega$ .

Measuring range (M $\Omega$ )	Resolution (M $\Omega$ )	Accuracy
0.00 ... 19.99	0.01	$\pm(5\%$ of reading + 3 digits)
20.0 ... 199.9	0.1	$\pm(5\%$ of reading)
200 ... 999	1	$\pm(10\%$ of reading)

**Uiso: 2500V (MI 3152H only)**

**Riso – Insulation resistance**

Measuring range ( $\Omega$ )	Resolution ( $\Omega$ )	Accuracy
0.00 M ... 19.99 M	0.01 M	$\pm(5\%$ of reading + 3 digits)
20.0 M ... 199.9 M	0.1 M	$\pm(5\%$ of reading)
200 M ... 999 M	1 M	$\pm(10\%$ of reading)
1.00 G ... 19.99 G	0.01 G	$\pm(10\%$ of reading)

**Um – Voltage**

Measuring range (V)	Resolution (V)	Accuracy
0 ... 2700	1	$\pm(3\%$ of reading + 3 digits)

Nominal voltages Uiso..... 50 V<sub>DC</sub>, 100 V<sub>DC</sub>, 250 V<sub>DC</sub>, 500 V<sub>DC</sub>, 1000 V<sub>DC</sub>,  
2500 V<sub>DC</sub> (MI 3152H only)

Open circuit voltage..... -0 % / +20 % of nominal voltage

Measuring current..... min. 1 mA at  $R_N = U_N \times 1 \text{ k}\Omega/\text{V}$

Short circuit current ..... max. 3 mA

The number of possible tests ..... > 700, with a fully charged battery

Auto discharge after test.

Specified accuracy is valid if 3-wire test lead is used while it is valid up to 100 M $\Omega$  if Tip commander is used.

Specified accuracy is valid up to 100 M $\Omega$  if relative humidity is > 85 %.

In case the instrument gets moistened, the results could be impaired. In such case, it is recommended to dry the instrument and accessories for at least 24 hours.

The error in operating conditions could be at most the error for reference conditions (specified in the manual for each function)  $\pm 5\%$  of measured value.

## 12.2 Diagnostic test (MI 3152H only)

Uiso: 500V, 1000 V, 2500 V

DAR – Dielectric absorption ratio

Measuring range	Resolution	Accuracy
0.01 ... 9.99	0.01	±(5 % of reading + 2 digits)
10.0 ... 100.0	0.1	±(5 % of reading)

PI – Polarization index

Measuring range	Resolution	Accuracy
0.01 ... 9.99	0.01	±(5 % of reading + 2 digits)
10.0 ... 100.0	0.1	±(5 % of reading)

For **Riso**, **R60**, and **Um** sub-results technical specifications defined in chapter **12.1 Riso – Insulation resistance** apply.

## 12.3 R low – Resistance of earth connection and equipotential bonding

Measuring range according to EN 61557 is 0.16  $\Omega$  ... 1999  $\Omega$ .

### R – Resistance

Measuring range ( $\Omega$ )	Resolution ( $\Omega$ )	Accuracy
0.00 ... 19.99	0.01	$\pm(3\%$ of reading + 3 digits)
20.0 ... 199.9	0.1	$\pm(5\%$ of reading)
200 ... 1999	1	

### R+, R – Resistance

Measuring range ( $\Omega$ )	Resolution ( $\Omega$ )	Accuracy
0.0 ... 199.9	0.1	$\pm(5\%$ of reading + 5 digits)
200 ... 1999	1	

Open-circuit voltage..... 6.5 VDC ... 18 VDC

Measuring current..... min. 200 mA into load resistance of 2  $\Omega$

Test lead compensation ..... up to 5  $\Omega$

The number of possible tests ..... > 1400, with a fully charged battery

Automatic polarity reversal of the test voltage.

## 12.4 Continuity – Continuous resistance measurement with low current

### R – Continuity resistance

Measuring range ( $\Omega$ )	Resolution ( $\Omega$ )	Accuracy
0.0 ... 19.9	0.1	$\pm(5\%$ of reading + 3 digits)
20 ... 1999	1	

Open-circuit voltage..... 6.5 VDC ... 18 VDC

Short-circuit current ..... max. 8.5 mA

Test lead compensation ..... up to 5  $\Omega$



## 12.5 RCD testing

### General data

Nominal residual current (A,AC).....	10 mA, 30 mA, 100 mA, 300 mA, 500 mA, 1000 mA
Nominal residual current accuracy .....	-0 / +0.1·I $\Delta$ ; I $\Delta$ = I $\Delta$ N, 2×I $\Delta$ N, 5×I $\Delta$ N -0.1·I $\Delta$ / +0; I $\Delta$ = 0.5×I $\Delta$ N AS/NZS 3017 selected: ± 5 %
Test current shape.....	Sine-wave (AC), pulsed (A, F), smooth DC (B, B+)
DC offset for pulsed test current.....	6 mA (typical)
RCD type .....	(non-delayed), S (time-delayed), PRCD, PRCD-K, PRCD-S
Test current starting polarity .....	0° or 180°
Voltage range .....	93 V ... 134 V (45 Hz ... 65 Hz) 185 V ... 266 V (45 Hz ... 65 Hz)

I $\Delta$ N (mA)	I $\Delta$ N × 1/2			I $\Delta$ N × 1			I $\Delta$ N × 2			I $\Delta$ N × 5			RCD I $\Delta$		
	AC	A, F	B, B+	AC	A, F	B, B+	AC	A, F	B, B+	AC	A, F	B, B+	AC	A, F	B, B+
10	5	3.5	5	10	20	20	20	40	40	50	100	100	✓	✓	✓
30	15	10.5	15	30	42	60	60	84	120	150	212	300	✓	✓	✓
100	50	35	50	100	141	200	200	282	400	500	707	1000	✓	✓	✓
300	150	105	150	300	424	600	600	848	n.a.	1500	n.a.	n.a.	✓	✓	✓
500	250	175	250	500	707	1000	1000	1410	n.a.	2500	n.a.	n.a.	✓	✓	✓
1000	500	350	500	1000	1410	n.a.	2000	n.a.	n.a.	n.a.	n.a.	n.a.	✓	✓	n.a.

n.a. .... not applicable

AC type ..... sine wave test current

A, F types..... pulsed current

B, B+ types ..... smooth DC current (MI 3152 only)

### 12.5.1 RCD U<sub>c</sub> – Contact voltage

Measuring range according to EN 61557 is 20.0 V ... 31.0 V for limit contact voltage 25 V

Measuring range according to EN 61557 is 20.0 V ... 62.0 V for limit contact voltage 50 V

#### U<sub>c</sub> – Contact voltage

Measuring range (V)	Resolution (V)	Accuracy
0.0 ... 19.9	0.1	(-0 % / +15 %) of reading ± 10 digits
20.0 ... 99.9	0.1	(-0 % / +15 %) of reading

The accuracy is valid if mains voltage is stable during the measurement and PE terminal is free of interfering voltages. Specified accuracy is valid for complete operating range.

Test current.....max. 0.5×I $\Delta$ N

Limit contact voltage ..... 25 V, 50 V

## 12.5.2 RCD t – Trip-out time

Complete measurement range corresponds to EN 61557 requirements.  
Maximum measuring times set according to selected reference for RCD testing.

### t<sub>ΔN</sub> – Trip-out time

Measuring range (ms)	Resolution (ms)	Accuracy
0.0 ... 40.0	0.1	±1 ms
0.0 ... max. time*	0.1	±3 ms

\* For max. time see normative references in chapter **4.6.4.1 RCD standard**. This specification applies to max. time >40 ms.

Test current..... $\frac{1}{2} \times I_{\Delta N}$ ,  $I_{\Delta N}$ ,  $2 \times I_{\Delta N}$ ,  $5 \times I_{\Delta N}$

$5 \times I_{\Delta N}$  is not available for  $I_{\Delta N}=1000$  mA (RCD type AC) or  $I_{\Delta N} \geq 300$  mA (RCD types A, F).

$2 \times I_{\Delta N}$  is not available for  $I_{\Delta N}=1000$  mA (RCD types A, F).

Specified accuracy is valid for complete operating range.

## 12.5.3 RCD I – Trip-out current

Complete measurement range corresponds to EN 61557 requirements.

### I<sub>Δ</sub> – Trip-out current

Measuring range	Resolution I <sub>Δ</sub>	Accuracy
$0.2 \times I_{\Delta N} \dots 1.1 \times I_{\Delta N}$ (AC type)	$0.05 \times I_{\Delta N}$	$\pm 0.1 \times I_{\Delta N}$
$0.2 \times I_{\Delta N} \dots 1.5 \times I_{\Delta N}$ (A type, $I_{\Delta N} \geq 30$ mA)	$0.05 \times I_{\Delta N}$	$\pm 0.1 \times I_{\Delta N}$
$0.2 \times I_{\Delta N} \dots 2.2 \times I_{\Delta N}$ (A type, $I_{\Delta N} < 30$ mA)	$0.05 \times I_{\Delta N}$	$\pm 0.1 \times I_{\Delta N}$
$0.2 \times I_{\Delta N} \dots 2.2 \times I_{\Delta N}$ (B type)	$0.05 \times I_{\Delta N}$	$\pm 0.1 \times I_{\Delta N}$

### t I<sub>Δ</sub> – Trip out-time

Measuring range (ms)	Resolution (ms)	Accuracy
0 ... 300	1	±3 ms

### U<sub>c</sub> I<sub>Δ</sub> – Contact voltage

Measuring range (V)	Resolution (V)	Accuracy
0.0 ... 19.9	0.1	(-0 % / +15 %) of reading ± 10 digits
20.0 ... 99.9	0.1	(-0 % / +15 %) of reading

The accuracy is valid if mains voltage is stable during the measurement and PE terminal is free of interfering voltages. Specified accuracy is valid for complete operating range.

Trip-out measurement is not available for  $I_{\Delta N}=1000$  mA (RCD types B, B+).

## 12.6 Z loop – Fault loop impedance and prospective fault current

### Z – Fault loop impedance

Measuring range according to EN 61557 is 0.25  $\Omega$  ... 9.99 k $\Omega$ .

Measuring range ( $\Omega$ )	Resolution ( $\Omega$ )	Accuracy
0.00 ... 9.99	0.01	$\pm(5\%$ of reading + 5 digits)
10.0 ... 99.9	0.1	
100 ... 999	1	$\pm 10\%$ of reading
1.00 k ... 9.99 k	10	

### Ipsc – Prospective fault current

Measuring range (A)	Resolution (A)	Accuracy
0.00 ... 9.99	0.01	Consider accuracy of fault loop resistance measurement
10.0 ... 99.9	0.1	
100 ... 999	1	
1.00 k ... 9.99 k	10	
10.0 k ... 23.0 k	100	

The accuracy is valid if mains voltage is stable during the measurement.

Test current (at 230 V)..... 6.5 A (10 ms)

Nominal voltage range..... 93 V ... 134 V (45 Hz ... 65 Hz)

185 V ... 266 V (45 Hz ... 65 Hz)

R, X<sub>L</sub> values are indicative.

## 12.7 Zs rcd –Fault loop impedance and prospective fault current in system with RCD

### Z – Fault loop impedance

Measuring range according to EN 61557 is 0.46  $\Omega$  ... 9.99 k $\Omega$ .

Measuring range ( $\Omega$ )	Resolution ( $\Omega$ )	Accuracy
0.00 ... 9.99	0.01	$\pm(5\%$ of reading + 10 digits)
10.0 ... 99.9	0.1	
100 ... 999	1	$\pm 10\%$ of reading
1.00 k ... 9.99 k	10	

Accuracy may be impaired in case of heavy noise on mains voltage.

### Ipsc – Prospective fault current

Measuring range (A)	Resolution (A)	Accuracy
0.00 ... 9.99	0.01	Consider accuracy of fault loop resistance measurement
10.0 ... 99.9	0.1	
100 ... 999	1	
1.00 k ... 9.99 k	10	
10.0 k ... 23.0 k	100	

Nominal voltage range..... 93 V ... 134 V (45 Hz ... 65 Hz)

185 V ... 266 V (45 Hz ... 65 Hz)

No trip out of RCD. R, X<sub>L</sub> values are indicative.

## 12.8 Z line – Line impedance and prospective short-circuit current

### Z – Line impedance

Measuring range according to EN 61557 is 0.25  $\Omega$  ... 9.99 k $\Omega$ .

Measuring range ( $\Omega$ )	Resolution ( $\Omega$ )	Accuracy
0.00 ... 9.99	0.01	$\pm(5\% \text{ of reading} + 5 \text{ digits})$
10.0 ... 99.9	0.1	
100 ... 999	1	$\pm 10\% \text{ of reading}$
1.00 k ... 9.99 k	10	

### Ipsc – prospective short-circuit current

Measuring range (A)	Resolution (A)	Accuracy
0.00 ... 0.99	0.01	Consider accuracy of line resistance measurement
1.0 ... 99.9	0.1	
100 ... 999	1	
1.00 k ... 99.99 k	10	
100 k ... 199 k	1000	

Test current (at 230 V)..... 6.5 A (10 ms)

Nominal voltage range..... 93 V ... 134 V (45 Hz ... 65 Hz)

185 V ... 266 V (45 Hz ... 65 Hz)

321 V ... 485 V (45 Hz ... 65 Hz)

R, X<sub>L</sub> values are indicative.

## 12.9 Voltage Drop

### dU – Voltage drop

Measuring range (%)	Resolution (%)	Accuracy
0.0 ... 99.9	0.1	Consider accuracy of line impedance measurement(s)*

Z<sub>REF</sub> measuring range..... 0.00  $\Omega$  ... 20.0  $\Omega$

Test current (at 230 V)..... 6.5 A (10 ms)

Nominal voltage range..... 93 V ... 134 V (45 Hz ... 65 Hz)

185 V ... 266 V (45 Hz ... 65 Hz)

321 V ... 485 V (45 Hz ... 65 Hz)

\*See chapter 7.13 **Voltage Drop** for more information about calculation of voltage drop result.

## 12.10 Rpe – PE conductor resistance

RCD: No

R – PE conductor resistance

Measuring range ( $\Omega$ )	Resolution ( $\Omega$ )	Accuracy
0.00 ... 19.99	0.01	$\pm(5\% \text{ of reading} + 5 \text{ digits})$
20.0 ... 99.9	0.1	
100.0 ... 199.9	0.1	$\pm 10\% \text{ of reading}$
200 ... 1999	1	

Measuring current..... min. 200 mA into PE resistance of 2  $\Omega$

RCD: Yes, no trip out of RCD

R – PE conductor resistance

Measuring range ( $\Omega$ )	Resolution ( $\Omega$ )	Accuracy
0.00 ... 19.99	0.01	$\pm(5\% \text{ of reading} + 10 \text{ digits})$
20.0 ... 99.9	0.1	
100.0 ... 199.9	0.1	$\pm 10\% \text{ of reading}$
200 ... 1999	1	

Accuracy may be impaired in case of heavy noise on mains voltage.

Measuring current..... < 15 mA

Nominal voltage range..... 93 V ... 134 V (45 Hz ... 65 Hz)  
185 V ... 266 V (45 Hz ... 65 Hz)

## 12.11 Earth – Earth resistance (3-wire measurement)

### Re – Earth resistance

Measuring range according to EN61557-5 is 2.00  $\Omega$  ... 1999  $\Omega$ .

Measuring range ( $\Omega$ )	Resolution ( $\Omega$ )	Accuracy
0.00 ... 19.99	0.01	$\pm(5\% \text{ of reading} + 5 \text{ digits})$
20.0 ... 199.9	0.1	
200 ... 9999	1	

Max. auxiliary earth electrode resistance  $R_C$  .....100 $\times R_E$  or 50 k $\Omega$  (whichever is lower)

Max. probe resistance  $R_P$  .....100 $\times R_E$  or 50 k $\Omega$  (whichever is lower)

Additional probe resistance error at  $R_{Cmax}$  or  $R_{Pmax}$ .  $\pm(10\% \text{ of reading} + 10 \text{ digits})$

Additional error at 3 V voltage noise (50 Hz) ..... $\pm(5\% \text{ of reading} + 10 \text{ digits})$

Open circuit voltage .....< 30 VAC

Short circuit current .....< 30 mA

Test voltage frequency .....125 Hz

Test voltage shape .....sine wave

Noise voltage indication threshold .....1 V (< 50  $\Omega$ , worst case)

Automatic measurement of auxiliary electrode resistance and probe resistance.

Automatic measurement of voltage noise.

## 12.12 Earth 2 clamp – Contactless earthing resistance measurement (with two current clamps)

### Re – Earth resistance

Measuring range ( $\Omega$ )	Resolution ( $\Omega$ )	Accuracy <sup>*)</sup>
0.00 ... 19.99	0.01	$\pm(10\% \text{ of reading} + 10 \text{ digits})$
20.0 ... 30.0	0.1	$\pm(20\% \text{ of reading})$
30.1 ... 39.9	0.1	$\pm(30\% \text{ of reading})$

<sup>\*)</sup> Distance between current clamps > 30 cm.

Additional error at 3 V voltage noise (50 Hz) ..... $\pm 10\% \text{ of reading}$

Test voltage frequency .....125 Hz

Noise current indication .....yes

Low clamp current indication .....yes

Additional clamp error has to be considered.

## 12.13 Ro – Specific earth resistance

$\rho$  – Specific earth resistance

Measuring range ( $\Omega\text{m}$ )	Resolution ( $\Omega\text{m}$ )	Accuracy
0.0 ... 99.9	0.1	See accuracy note
100 ... 999	1	
1.00 k ... 9.99 k	0.01 k	
10.0 k ... 99.9 k	0.1 k	
100 k ... 9999 k	1 k	

$\rho$  – Specific earth resistance

Measuring range ( $\Omega\text{ft}$ )	Resolution ( $\Omega\text{ft}$ )	Accuracy
0.0 ... 99.9	0.1	See accuracy note
100 ... 999	1	
1.00 k ... 9.99 k	0.01 k	
10.0 k ... 99.9 k	0.1 k	
100 k ... 9999 k	1 k	

Principle:

$$\rho = 2 \cdot \pi \cdot d \cdot R_e$$

where  $R_e$  is a measured resistance in 4-wire method and  $d$  is distance between the probes.

### Accuracy note:

Accuracy of the specific earth resistance result depends on measured earth resistance  $R_e$  as follows:

$R_e$  – Earth resistance

Measuring range ( $\Omega$ )	Accuracy
1.00 ... 1999	$\pm 5$ % of measured value
2000 ... 19.99 k	$\pm 10$ % of measured value
>20 k	$\pm 20$ % of measured value

Additional error:

See *Earth resistance three-wire method*.

## 12.14 Voltage, frequency, and phase rotation

### 12.14.1 Phase rotation

Nominal system voltage range ..... 100 V<sub>AC</sub> ... 550 V<sub>AC</sub>

Nominal frequency range ..... 14 Hz ... 500 Hz

Result displayed ..... 1.2.3 or 3.2.1

### 12.14.2 Voltage

Measuring range (V)	Resolution (V)	Accuracy
0 ... 550	1	±(2 % of reading + 2 digits)

Result type ..... True r.m.s. (TRMS)

Nominal frequency range ..... 0 Hz, 14 Hz ... 500 Hz

### 12.14.3 Frequency

Measuring range (Hz)	Resolution (Hz)	Accuracy
0.00 ... 9.99	0.01	±(0.2 % of reading + 1 digit)
10.0 ... 499.9	0.1	

Nominal voltage range.....20 V ... 550 V

### 12.14.4 Online terminal voltage monitor

Measuring range (V)	Resolution (V)	Accuracy
10 ... 550	1	±(2 % of reading + 2 digits)



## 12.15 Currents

Instrument

Maximum voltage on C1 measuring input..... 3 V

Nominal frequency..... 0 Hz, 40 Hz ... 500 Hz

**Ch1 clamp type: A1018**

**Range: 20 A**

**I1 – Current**

Measuring range (A)	Resolution (A)	Accuracy*
0.0 m ... 99.9 m	0.1 m	$\pm(5\% \text{ of reading} + 5 \text{ digits})$
100 m ... 999 m	1 m	$\pm(3\% \text{ of reading} + 3 \text{ digits})$
1.00 ... 19.99	0.01	$\pm(3\% \text{ of reading})$

**Ch1 clamp type: A1019**

**Range: 20 A**

**I1 – Current**

Measuring range (A)	Resolution (A)	Accuracy*
0.0 m ... 99.9 m	0.1 m	indicative
100 m ... 999 m	1 m	$\pm(5\% \text{ of reading})$
1.00 ... 19.99	0.01	$\pm(3\% \text{ of reading})$

**Ch1 clamp type: A1391**

**Range: 40 A**

**I1 – Current**

Measuring range (A)	Resolution (A)	Accuracy*
0.00 ... 1.99	0.01	$\pm(3\% \text{ of reading} + 3 \text{ digits})$
2.00 ... 19.99	0.01	$\pm(3\% \text{ of reading})$
20.0 ... 39.9	0.1	$\pm(3\% \text{ of reading})$

**Ch1 clamp type: A1391**

**Range: 300 A**

**I1 – Current**

Measuring range (A)	Resolution (A)	Accuracy*
0.00 ... 19.99	0.01	indicative
20.0 ... 39.9	0.1	
40.0 ... 299.9	0.1	$\pm(3\% \text{ of reading} + 5 \text{ digits})$

\* Accuracy at operating conditions for instrument and current clamp is given.

## 12.16 Power

### Measurement characteristics

Function symbols	Class according to IEC 61557-12	Measuring range
P – Active power	2.5	5 % ... 100 % $I_{Nom}^{*)}$
S – Apparent power	2.5	5 % ... 100 % $I_{Nom}^{*)}$
Q – Reactive power	2.5	5 % ... 100 % $I_{Nom}^{*)}$
PF – Power factor	1	- 1 ... 1
THDu	2.5	0 % ... 20 % $U_{Nom}$

<sup>\*)</sup>  $I_{Nom}$  depends on selected current clamp type and selected range as follows:

A 1018: [20 A]

A1019: [20 A]

A 1391: [40 A, 300 A]

Function	Measuring range
Power (P, S, Q)	0.00 W (VA, Var) ... 99.9 kW (kVA, kVar)
Power factor	-1.00 ... 1.00
Voltage THD	0.1 % ... 99.9 %

Error of external voltage and current transducers is not considered in this specification.

## 12.17 Harmonics

### Measurement characteristics

Function symbols	Class according to IEC 61557-12	Measuring range
Uh	2.5	0 % ... 20 % $U_{Nom}$
THDu	2.5	0 % ... 20 % $U_{Nom}$
Ih	2.5	0 % ... 100 % $I_{Nom}^{*)}$
THDi	2.5	0 % ... 100 % $I_{Nom}^{*)}$

<sup>\*)</sup>  $I_{Nom}$  depends on selected current clamp type and selected range as follows:

A 1018: [20 A]

A1019: [20 A]

A 1391: [40 A, 300 A]

Function	Measuring range
Voltage harmonics	0.1 V ... 500 V
Voltage THD	0.1 % ... 99.9 %
Current harmonics and Current THD	0.00 A ... 199.9 A

Error of external voltage and current transducers is not considered in this specification.

## 12.18 ISFL – First fault leakage current (MI 3152 only)

### Isc1, Isc2 – First fault leakage current

Measuring range (mA)	Resolution (mA)	Accuracy
0.0 ... 19.9	0.1	±(5 % of reading + 3 digits)

Measuring resistance .....approx. 390 Ω

Nominal voltage ranges.....93 V ≤ U<sub>L1-L2</sub> < 134 V

185 V ≤ U<sub>L1-L2</sub> ≤ 266 V

## 12.19 IMD (MI 3152 only)

### R1, R2 – Threshold insulation resistance

R (kΩ)	Resolution (kΩ)	Notes
5 ... 640	5	up to 128 steps

### I1, I2 – First fault leakage current at threshold insulation resistance

I (mA)	Resolution (mA)	Note
0.0 ... 19.9	0.1	calculated value <sup>*)</sup>

Nominal voltage ranges.....93 V ≤ U<sub>L1-L2</sub> ≤ 134 V

185 V ≤ U<sub>L1-L2</sub> ≤ 266 V

<sup>\*)</sup>See chapter **7.21 IMD – Testing of insulation monitoring devices (MI 3152 only)** for more information about calculation of first fault leakage current at threshold insulation resistance.

## 12.20 Illumination

### Illumination (LUXmeter sensor, type B)

Specified accuracy is valid for complete operating range.

Measuring range (lux)	Resolution (lux)	Accuracy
0.01 ... 19.99	0.01	$\pm(5\% \text{ of reading} + 2 \text{ digits})$
20.0 ... 199.9	0.1	$\pm(5\% \text{ of reading})$
200 ... 1999	1	
2.00 ... 19.99 k	10	

Measurement principle ..... silicon photodiode with  $V(\lambda)$  filter

Spectral response error .....  $< 3.8\%$  according to CIE curve

Cosine error .....  $< 2.5\%$  up to an incident angle of  $\pm 85^\circ$

Overall accuracy ..... matched to DIN 5032 class B standard

### Illumination (LUXmeter sensor, type C)

Specified accuracy is valid for complete operating range.

Measuring range (lux)	Resolution (lux)	Accuracy
0.01 ... 19.99	0.01	$\pm(10\% \text{ of reading} + 3 \text{ digits})$
20.0 ... 199.9	0.1	$\pm(10\% \text{ of reading})$
200 ... 1999	1	
2.00 ... 19.99 k	10	

Measurement principle ..... silicon photodiode

Cosine error .....  $< 2.5\%$  up to an incident angle of  $\pm 85^\circ$

Overall accuracy ..... matched to DIN 5032 class C standard

## 12.21 General data

Power supply .....	6 x 1.2 V Ni-MH battery cells, size AA
Operation .....	typical 9 h
Charger socket input voltage.....	12 V $\pm$ 10 %
Charger socket input current.....	1000 mA max.
Battery charging current .....	125 mA (normal charging mode) 725 mA (fast charging mode)
Measuring category .....	600 V CAT III 300 V CAT IV
Protection classification .....	double insulation
Pollution degree.....	2
Protection degree .....	IP 40
Display .....	4.3 inch (10.9 cm) 480x272 pixels TFT colour display with touch screen
Dimensions (w $\times$ h $\times$ d).....	23 cm $\times$ 10.3 cm $\times$ 11.5 cm
Weight.....	1.3 kg, without battery cells

### Reference conditions

Reference temperature range .....	10 °C ... 30 °C
Reference humidity range .....	40 %RH ... 70 %RH

### Operation conditions

Working temperature range.....	0 °C ... 40 °C
Maximum relative humidity .....	95 %RH (0 °C ... 40 °C), non-condensing

### Storage conditions

Temperature range.....	-10 °C ... +70 °C
Maximum relative humidity .....	90 %RH (-10 °C ... +40 °C) 80 %RH (40 °C ... 60 °C)

### Communication ports, memory

RS 232 .....	115200 bits/s, 8N1 serial protocol
USB.....	USB 2.0 Hi speed interface with USB type B receptacle connector
Data storage capacity .....	8 GB internal memory
Bluetooth module.....	Class 2

The error in operating conditions could be at most the error for reference conditions (specified in the manual for each function) +1 % of measured value + 1 digit, unless otherwise specified in the manual for particular function.

## Appendix A – Fuse table – IPSC

### Fuse type NV

Rated current (A)	Disconnection time [s]				
	35m	0.1	0.2	0.4	5
	Min. prospective short-circuit current (A)				
2	32.5	22.3	18.7	15.9	9.1
4	65.6	46.4	38.8	31.9	18.7
6	102.8	70	56.5	46.4	26.7
10	165.8	115.3	96.5	80.7	46.4
16	206.9	150.8	126.1	107.4	66.3
20	276.8	204.2	170.8	145.5	86.7
25	361.3	257.5	215.4	180.2	109.3
35	618.1	453.2	374	308.7	169.5
50	919.2	640	545	464.2	266.9
63	1217.2	821.7	663.3	545	319.1
80	1567.2	1133.1	964.9	836.5	447.9
100	2075.3	1429	1195.4	1018	585.4
125	2826.3	2006	1708.3	1454.8	765.1
160	3538.2	2485.1	2042.1	1678.1	947.9
200	4555.5	3488.5	2970.8	2529.9	1354.5
250	6032.4	4399.6	3615.3	2918.2	1590.6
315	7766.8	6066.6	4985.1	4096.4	2272.9
400	10577.7	7929.1	6632.9	5450.5	2766.1
500	13619	10933.5	8825.4	7515.7	3952.7
630	19619.3	14037.4	11534.9	9310.9	4985.1
710	19712.3	17766.9	14341.3	11996.9	6423.2
800	25260.3	20059.8	16192.1	13545.1	7252.1
1000	34402.1	23555.5	19356.3	16192.1	9146.2
1250	45555.1	36152.6	29182.1	24411.6	13070.1

## Fuse type gG

Rated current (A)	Disconnection time [s]				
	35m	0.1	0.2	0.4	5
	Min. prospective short-circuit current (A)				
2	32.5	22.3	18.7	15.9	9.1
4	65.6	46.4	38.8	31.9	18.7
6	102.8	70	56.5	46.4	26.7
10	165.8	115.3	96.5	80.7	46.4
13	193.1	144.8	117.9	100	56.2
16	206.9	150.8	126.1	107.4	66.3
20	276.8	204.2	170.8	145.5	86.7
25	361.3	257.5	215.4	180.2	109.3
32	539.1	361.5	307.9	271.7	159.1
35	618.1	453.2	374	308.7	169.5
40	694.2	464.2	381.4	319.1	190.1
50	919.2	640	545	464.2	266.9
63	1217.2	821.7	663.3	545	319.1
80	1567.2	1133.1	964.9	836.5	447.9
100	2075.3	1429	1195.4	1018	585.4

## Fuse type B

Rated current (A)	Disconnection time [s]				
	35m	0.1	0.2	0.4	5
	Min. prospective short-circuit current (A)				
6	30	30	30	30	30
10	50	50	50	50	50
13	65	65	65	65	65
15	75	75	75	75	75
16	80	80	80	80	80
20	100	100	100	100	100
25	125	125	125	125	125
32	160	160	160	160	160
40	200	200	200	200	200
50	250	250	250	250	250
63	315	315	315	315	315

## Fuse type C

Rated current (A)	Disconnection time [s]				
	35m	0.1	0.2	0.4	5
	Min. prospective short-circuit current (A)				
0.5	5	5	5	5	2.7
1	10	10	10	10	5.4
1.6	16	16	16	16	8.6
2	20	20	20	20	10.8
4	40	40	40	40	21.6
6	60	60	60	60	32.4
10	100	100	100	100	54
13	130	130	130	130	70.2
15	150	150	150	150	83
16	160	160	160	160	86.4
20	200	200	200	200	108
25	250	250	250	250	135
32	320	320	320	320	172.8
40	400	400	400	400	216
50	500	500	500	500	270
63	630	630	630	630	340.2

## Fuse type D

Rated current (A)	Disconnection time [s]				
	35m	0.1	0.2	0.4	5
	Min. prospective short-circuit current (A)				
0.5	10	10	10	10	2.7
1	20	20	20	20	5.4
1.6	32	32	32	32	8.6
2	40	40	40	40	10.8
4	80	80	80	80	21.6
6	120	120	120	120	32.4
10	200	200	200	200	54
13	260	260	260	260	70.2
15	300	300	300	300	81
16	320	320	320	320	86.4
20	400	400	400	400	108
25	500	500	500	500	135
32	640	640	640	640	172.8



## Fuse type K

Rated current (A)	Disconnection time [s]				
	35m	0.1	0.2	0.4	
	Min. prospective short-circuit current (A)				
0.5	7.5	7.5	7.5	7.5	
1	15	15	15	15	
1.6	24	24	24	24	
2	30	30	30	30	
4	60	60	60	60	
6	90	90	90	90	
10	150	150	150	150	
13	195	195	195	195	
15	225	225	225	225	
16	240	240	240	240	
20	300	300	300	300	
25	375	375	375	375	
32	480	480	480	480	

## Appendix B – Profile Notes

Instrument supports working with multiple Profiles. This appendix contains collection of minor modifications related to particular country requirements. Some of the modifications mean modified listed function characteristics related to main chapters and others are additional functions. Some minor modifications are related also to different requirements of the same market that are covered by various suppliers.

### B.1 Profile Austria (ALAJ)

Testing special delayed G type RCD supported.

Modifications in chapter **7.6 Testing RCDs**

Special delayed G type RCD selection added in the **Selectivity** parameter in **Test Parameters / Limits** section as follows:

---

**Selectivity**    **Characteristic** [--, S, G]

---

Time limits are the same as for general type RCD and contact voltage is calculated the same as for general type RCD.

Selective (time delayed) RCDs and RCDs with (G) - time delayed characteristic demonstrate delayed response characteristics. They contain residual current integrating mechanism for generation of delayed trip out. However, contact voltage pre-test in the measuring procedure also influences the RCD and it takes a period to recover into idle state. Time delay of 30 s is inserted before performing trip-out test to recover S type RCD after pre-tests and time delay of 5 s is inserted for the same purpose for G type RCD.

**Table 7.1: Relationship between  $U_c$  and  $I_{\Delta N}$**  changed as follows:

RCD type		Contact voltage $U_c$ proportional to	Rated $I_{\Delta N}$	Notes
AC	--	$1.05 \times I_{\Delta N}$	any	All models
	G			
AC	S	$2 \times 1.05 \times I_{\Delta N}$	$\geq 30 \text{ mA}$	
A, F	--	$1.4 \times 1.05 \times I_{\Delta N}$		
	G			
A, F	S	$2 \times 1.4 \times 1.05 \times I_{\Delta N}$		
A, F	--	$2 \times 1.05 \times I_{\Delta N}$		
	G			
A, F	S	$2 \times 2 \times 1.05 \times I_{\Delta N}$	any	Model MI 3152 only
B, B+	--	$2 \times 1.05 \times I_{\Delta N}$		
B, B+	S	$2 \times 2 \times 1.05 \times I_{\Delta N}$		

Technical specifications unchanged.

## B.2 Profile Finland (profile code ALAC)

Modification of Appendix A - Fuse base table changed as follows:

Modified Fuse type NV

Rated current (A)	Disconnection time [s]				
	35m	0.1	0.2	0.4	5
	Min. prospective short-circuit current (A)				
2	40.6	27.9	23.4	19.9	11.4
4	82	58	48.5	39.9	23.4
6	128.5	87.5	70.6	58	33.4
10	207.3	144.1	120.6	100.9	58
16	258.6	188.5	157.6	134.3	82.9
20	346	255.3	213.5	181.9	108.4
25	451.6	321.9	269.3	225.3	136.6
35	772.6	566.5	467.5	385.9	211.9
50	1150	800	681.3	580.3	333.6
63	1520	1030	829.1	681.3	398.9
80	1960	1420	1210	1050	559.9
100	2590	1790	1490	1270	731.8
125	3530	2510	2140	1820	956.4
160	4420	3110	2550	2100	1180
200	5690	4360	3710	3160	1690
250	7540	5500	4520	3650	1990
315	9710	7580	6230	5120	2840
400	13220	9910	8290	6810	3460
500	17020	13670	11030	9390	4940
630	24520	17550	14420	11640	6230
710	24640	22210	17930	15000	8030
800	31580	25070	20240	16930	9070
1000	43000	29440	24200	20240	11430
1250	56940	45190	36480	30510	16340

## Modified Fuse type gG

Rated current (A)	Disconnection time [s]				
	35m	0.1	0.2	0.4	5
	Min. prospective short-circuit current (A)				
2	40.6	27.9	23.4	19.9	11.4
4	82	58	48.5	39.9	23.4
6	128.5	87.5	70.6	58	33.4
10	207.3	144.1	120.6	100.9	58
13	241.4	181	147.4	125	70.3
16	258.6	188.5	157.6	134.3	82.9
20	346	255.3	213.5	181.9	108.4
25	451.6	321.9	269.3	225.3	136.6
32	673.9	451.9	384.9	339.6	198.9
35	772.6	566.5	467.5	385.9	211.9
40	867.8	580.3	476.8	398.9	237.6
50	1150	800	681.3	580.3	333.6
63	1520	1030	829.1	681.3	398.9
80	1960	1420	1210	1050	559.9
100	2590	1790	1490	1270	731.8

## Modified Fuse type B

Rated current (A)	Disconnection time [s]				
	35m	0.1	0.2	0.4	5
	Min. prospective short-circuit current (A)				
0.5	6.3	6.3	6.3	6.3	4.4
1	12.5	12.5	12.5	12.5	8.8
1.6	20	20	20	20	14
2	25	25	25	25	17.5
4	50	50	50	50	35
6	37.5	37.5	37.5	37.5	37.5
10	62.5	62.5	62.5	62.5	62.5
13	81.3	81.3	81.3	81.3	81.3
15	93.8	93.8	93.8	93.8	93.8
16	100	100	100	100	100
20	125	125	125	125	125
25	156.3	156.3	156.3	156.3	156.3
32	200	200	200	200	200
40	250	250	250	250	250
50	312.5	312.5	312.5	312.5	312.5
63	393.8	393.8	393.8	393.8	393.8

## Modified Fuse type C

Rated current (A)	Disconnection time [s]				
	35m	0.1	0.2	0.4	5
	Min. prospective short-circuit current (A)				
0.5	6.3	6.3	6.3	6.3	4.4
1	12.5	12.5	12.5	12.5	8.8
1.6	20	20	20	20	14
2	25	25	25	25	17.5
4	50	50	50	50	35
6	75	75	75	75	52.5
10	125	125	125	125	87.5
13	162.5	162.5	162.5	162.5	113.8
15	187.5	187.5	187.5	187.5	131.3
16	200	200	200	200	140
20	250	250	250	250	175
25	312.5	312.5	312.5	312.5	218.8
32	400	400	400	400	280
40	500	500	500	500	350
50	625	625	625	625	437.5
63	787.5	787.5	787.5	787.5	551.3

## Modified Fuse type D

Rated current (A)	Disconnection time [s]				
	35m	0.1	0.2	0.4	5
	Min. prospective short-circuit current (A)				
0.5	12.5	12.5	12.5	12.5	4.4
1	25	25	25	25	8.8
1.6	40	40	40	40	14
2	50	50	50	50	17.5
4	100	100	100	100	35
6	150	150	150	150	42.5
10	250	250	250	250	87.5
13	325	325	325	325	113.8
15	375	375	375	375	131.3
16	400	400	400	400	140
20	500	500	500	500	175
25	625	625	625	625	218.8
32	800	800	800	800	280

## Modified Fuse type K

Rated current (A)	Disconnection time [s]				
	35m	0.1	0.2	0.4	
	Min. prospective short-circuit current (A)				
<b>0.5</b>	9.4	9.4	9.4	9.4	
<b>1</b>	18.8	18.8	18.8	18.8	
<b>1.6</b>	30	30	30	30	
<b>2</b>	37.5	37.5	37.5	37.5	
<b>4</b>	75	75	75	75	
<b>6</b>	112.5	112.5	112.5	112.5	
<b>10</b>	187.5	187.5	187.5	187.5	
<b>13</b>	243.8	243.8	243.8	243.8	
<b>15</b>	281.3	281.3	281.3	281.3	
<b>16</b>	300	300	300	300	
<b>20</b>	375	375	375	375	
<b>25</b>	468.8	468.8	468.8	468.8	
<b>32</b>	600	600	600	600	

## B.3 Profile Hungary (profile code ALAD)

Fuse type gR added to the fuse tables.

### Fuse type gR

Rated current (A)	Disconnection time [s]				
	35m	0.1	0.2	0.4	5
	Min. prospective short-circuit current (A)				
2	31.4	14	10	8	5
4	62.8	28	20	16	10
6	94.2	42	30	24	15
10	157	70	50	40	25
13	204	91	65	52	32.5
16	251	112	80	64	40
20	314	140	100	80	50
25	393	175	125	100	62.5
32	502	224	160	128	80
35	550	245	175	140	87.5
40	628	280	200	160	100
50	785	350	250	200	125
63	989	441	315	252	157.5
80	1256	560	400	320	200
100	1570	700	500	400	250
125	1963	875	625	500	313
160	2510	1120	800	640	400
200	3140	1400	1000	800	500
250	3930	1750	1250	1000	625
315	4950	2210	1575	1260	788
400	6280	2800	2000	1600	1000
500	7850	3500	2500	2000	1250
630	9890	4410	3150	2520	1575
710	11150	4970	3550	2840	1775
800	12560	5600	4000	3200	2000
1000	15700	7000	5000	4000	2500
1250	19630	8750	6250	5000	3130

New Single test function **Visual Test** added.

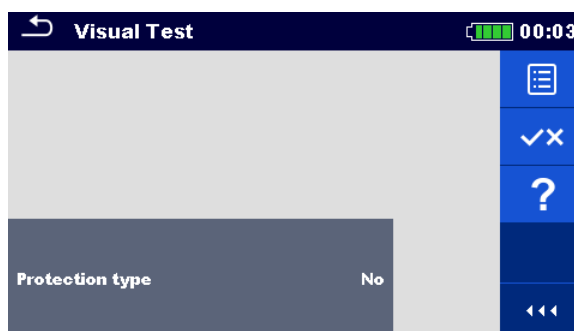



Figure 12.1: Visual Test menu

Measurement parameters / limits

<b>Protection type</b>	<b>Protection type</b> [No, Automatic disconnection, Class II, Electrical separation, SELV, PELV]
------------------------	---

Measurement procedure

- › Enter the **Visual Test** function.
- › Set test parameters / limits.
- › Perform the visual inspection on tested object.
- › Use  to select PASS / FAIL / NO STATUS indication.
- › Save results (optional).

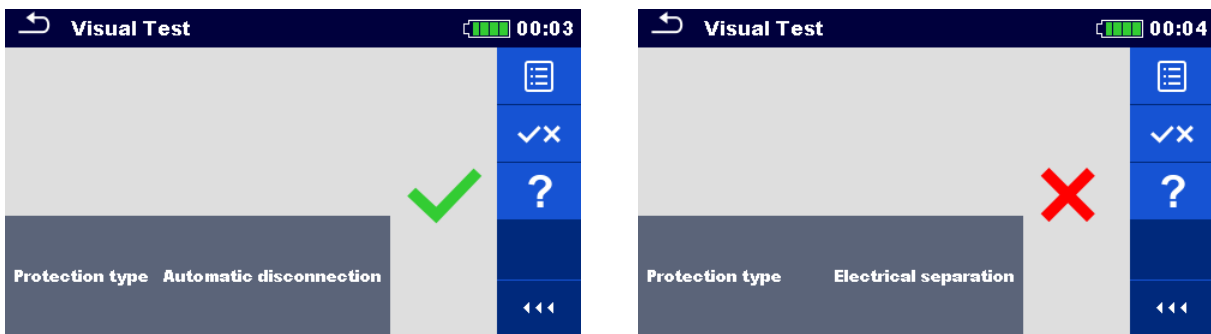

Figure 12.2: Examples of Visual Test result

Modifications in chapter 7.7 RCD Auto – RCD Auto test

Added tests with multiplication factor 2.

Modification of RCD Auto test procedure

RCD Auto test inserted steps	Notes
› <b>Re-activate RCD.</b> Test with $2 \times I_{\Delta N}$ , (+) positive polarity (new step 3).	RCD should trip-out
› <b>Re-activate RCD.</b> Test with $2 \times I_{\Delta N}$ , (-) negative polarity (new step 4).	RCD should trip-out

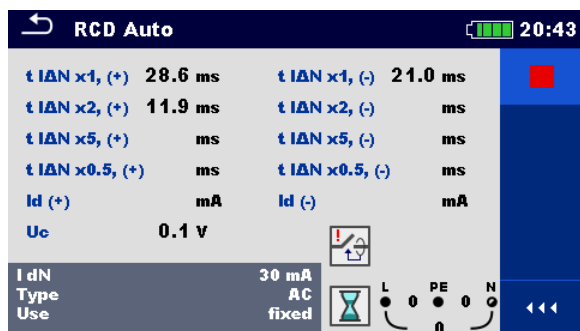

Inserted new Step 3

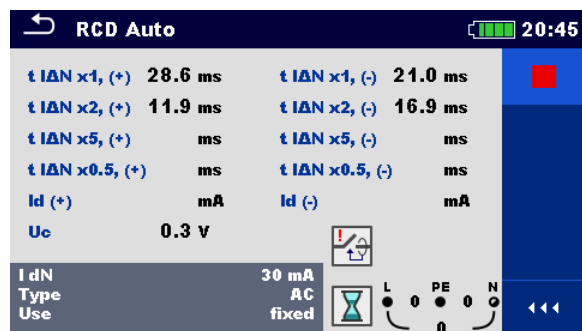

Inserted new Step 4

Figure 7.27: Individual steps in RCD Auto test – Inserted 2 new steps



**Test results / sub-results**

<b>t I<sub>ΔN</sub> x1 (+)</b>	Step 1 trip-out time ( $I_{\Delta}=I_{\Delta N}$ , (+) positive polarity)
<b>t I<sub>ΔN</sub> x1 (-)</b>	Step 2 trip-out time ( $I_{\Delta}=I_{\Delta N}$ , (-) negative polarity)
<b>t I<sub>ΔN</sub> x2 (+)</b>	Step 3 trip-out time ( $I_{\Delta}=2\times I_{\Delta N}$ , (+) positive polarity)
<b>t I<sub>ΔN</sub> x2 (-)</b>	Step 4 trip-out time ( $I_{\Delta}=2\times I_{\Delta N}$ , (-) negative polarity)
<b>t I<sub>ΔN</sub> x5 (+)</b>	Step 5 trip-out time ( $I_{\Delta}=5\times I_{\Delta N}$ , (+) positive polarity)
<b>t I<sub>ΔN</sub> x5 (-)</b>	Step 6 trip-out time ( $I_{\Delta}=5\times I_{\Delta N}$ , (-) negative polarity)
<b>t I<sub>ΔN</sub> x0.5 (+)</b>	Step 7 trip-out time ( $I_{\Delta}=\frac{1}{2}\times I_{\Delta N}$ , (+) positive polarity)
<b>t I<sub>ΔN</sub> x0.5 (-)</b>	Step 8 trip-out time ( $I_{\Delta}=\frac{1}{2}\times I_{\Delta N}$ , (-) negative polarity)
<b>I<sub>d</sub> (+)</b>	Step 9 trip-out current ((+) positive polarity)
<b>I<sub>d</sub> (-)</b>	Step 10 trip-out current ((-) negative polarity)
<b>U<sub>c</sub></b>	Contact voltage for rated $I_{\Delta N}$

**B.4 Profile Switzerland (profile code ALAI)**

Modifications in Chapter **4.4.1 Terminal voltage monitor**

In the Terminal voltage monitor the positions of L and N indications are opposite to standard version.

Voltage monitor example:

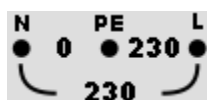

Online voltages are displayed together with test terminal indication. All three test terminals are used for selected measurement.

**B.5 Profile UK (profile code ALAB)**

For modifications and UK fuse tables refer to separate UK Instruction manual.

**B.6 Profile AUS/NZ (profile code ALAE)**

For modifications and AUS/NZ fuse tables refer to separate AUS/NZ Instruction manual.

## Appendix C – Commanders (A 1314, A 1401)

### C.1 ⚠ Warnings related to safety

#### Measuring category of commanders

Plug commander A 1314.....300 V CAT II

Tip commander A 1401

(cap off, 18 mm tip) .....1000 V CAT II / 600 V CAT II / 300 V CAT II

(cap on, 4 mm tip) .....1000 V CAT II / 600 V CAT III / 300 V CAT IV

- Measuring category of commanders can be lower than protection category of the instrument.
- If dangerous voltage is detected on the tested PE terminal, immediately stop all measurements, find and remove the fault!
- When replacing battery cells or before opening the battery compartment cover, disconnect the measuring accessory from the instrument and installation.
- Service, repairs or adjustment of instruments and accessories is only allowed to be carried out by competent authorized personnel!

### C.2 Battery

The commander uses two AAA size alkaline or rechargeable Ni-MH battery cells. Nominal operating time is at least 40 h and is declared for cells with nominal capacity of 850 mAh.

#### Notes:

- If the commander is not used for a long period of time, remove all batteries from the battery compartment.
- Alkaline or rechargeable Ni-MH batteries (size AAA) can be used. Metrel recommends only using rechargeable batteries with a capacity of 800 mAh or above.
- Ensure that the battery cells are inserted correctly otherwise the commander will not operate and the batteries could be discharged.

### C.3 Description of commanders

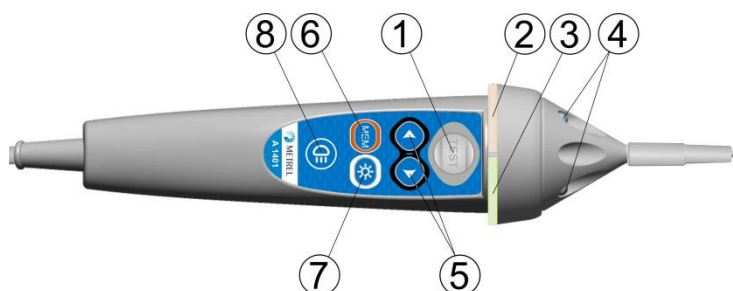

Figure D.3: Front side Tip commander (A 1401)

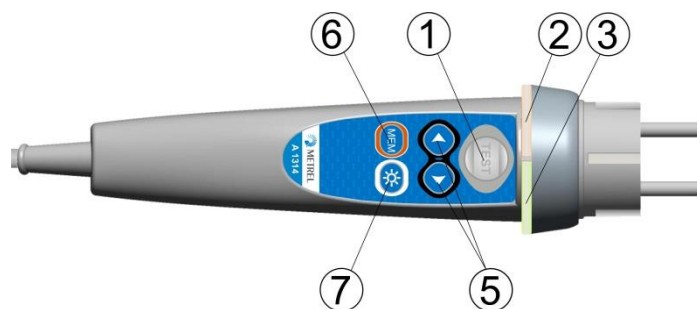

Figure D.4: Front side Plug commander (A 1314)

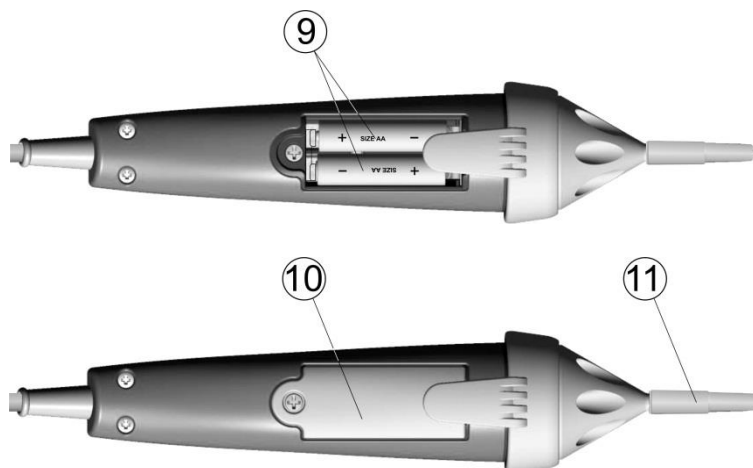

Figure D.5: Back side



1	TEST	TEST	Starts measurements. Acts also as the PE touching electrode.
2	LED	Left status	RGB LED
3	LED	Right status	RGB LED
4	LEDs	Lamp LEDs (Tip commander)	
5	Function selector	Selects test function.	
6	MEM	Store / recall / clear tests in memory of instrument.	
7	BL	Switches On / Off backlight on instrument	
8	Lamp key	Switches On / Off lamp (Tip commander)	
9	Battery cells	Size AAA, alkaline / rechargeable Ni-MH	
10	Battery cover	Battery compartment cover	
11	Cap	Removable CAT IV cap (Tip commander)	













## C.4 Operation of commanders

Both LED yellow	Warning! Dangerous voltage on the commander's PE terminal!
Right LED red	Fail indication
Right LED green	Pass indication
Left LED blinks blue	Commander is monitoring the input voltage
Left LED orange	Voltage between any test terminals is higher than 50 V
Both LEDs blink red	Low battery
Both LEDs red and switch off	Battery voltage too low for operation of commander

## Appendix D – Structure objects

Structure elements used in Memory Organizer are instrument's Profile dependent.

Symbol	Default name	Description
	Node	Node
	Object	Object
	Dist. board	Distribution board
	Sub D. Board	Sub Distribution board
	Local bonding	Local equipotential bonding
	Water Service	Protective conductor for Water service
	Oil service	Protective conductor for Oil service
	Lightn. protect.	Protective conductor for Lightning protection
	Gas service	Protective conductor for Gas service
	Struct. steel	Protective conductor for Structural steel
	Other service	Protective conductor for Other incoming service
	Earthing cond.	Earthing conductor
	Circuit	Circuit
	Local bonding	Local equipotential bonding
	Connection	Connection
	Socket	Socket
	Connection 3-ph	Connection - 3 phase
	Light	Light
	Socket 3-ph	Socket - 3 phase
	RCD	RCD
	MPE	MPE
	Foundation gr.	Protective conductor for Foundation ground
	Equip. bond. rail	Equipotential bonding rail
	House water m.	Protection conductor for House water meter
	Main water p.	Protection conductor for Main water pipes
	Main gr. cond.	Main grounding conductor
	Inter. gas inst.	Protective conductor for Interior gas installation
	Heat.inst.	Protective conductor for Heating installation
	Air cond. inst.	Protective conductor for Air conditioning installation
	Lift inst.	Protective conductor for Lift installation

	Data proc. Inst.	Protective conductor for Lift Data processing installation
	Teleph. Inst.	Protective conductor for Telephone installation
	Lightrn. prot. syst.	Protective conductor for Lightning protection system
	Antenna inst.	Protective conductor for Antenna installation
	Build. Constr.	Protective conductor for Building construction
	Other conn.	Other connection
	Earth electrode	Earth electrode
	Lightning Sys.	Lightning System
	Lightning. electr.	Lightning electrode
	Inverter	Inverter
	String	String array
	Panel	Panel