

SMRT36

Megger Relay Test System



SMRT36 with optional
Transducer hardware

- **Small, rugged, lightweight and powerful**
- **Operate with or without a computer**
- **Intuitive manual operation with Smart Touch View Interface**
- **High current, high power output (60 Amps/300 VA rms) per phase**
- **Convertible channels provides 6 currents**
- **Network interface provides IEC 61850 test capabilities**
- **Optional transducer test capability**
- **Fully automated testing using AVTS Software**

DESCRIPTION

For size, weight, and features the SMRT36 is conceivably the smallest, lightest, highest output powered, complete three phase relay test system in the world today. The test system may be customized by adding the number of Voltage-Current, "VIGEN", modules needed for specific test applications. The SMRT36 has the "smart" combination of high compliance voltage and high current to test all electromechanical, solid-state and microprocessor-based overcurrent relays, including voltage controlled, voltage restraint and directional overcurrent.

The SMRT36 with three VIGEN Modules provides a complete three-phase test system for commissioning of three phase protection systems. With the voltage channels converted to currents, the same unit can provide 6-phase current. The SMRT36 VIGEN modules also provide high power in BOTH the voltage and current channels to test virtually all types of protective relays.



SMRT36 with STVI

The SMRT36 test system has the ability to be manually controlled with Megger's new Smart Touch View Interface™ (STVI). The STVI, with its large, full color, high resolution, TFT LCD touch screen allows the user to perform manual, steady-state and dynamic testing quickly and easily using the manual test screen, as well as using built-in preset test routines for most popular relays.

The STVI eliminates the need for a computer when testing virtually all types of relays. Menu screens and touch screen function buttons are provided to quickly and easily select the desired test function. Tests results can be saved to the STVI for download to a memory stick to transfer or print test reports.

For full automatic testing the SMRT36 may be controlled by Megger Advanced Visual Test Software (AVTS). AVTS is a Microsoft® Windows® XP®/Vista™/7 compatible software program designed to manage all aspects of protective relay testing using the new Megger SMRT.

APPLICATIONS

Each current channel is rated for 30 Amps @ 200 VA continuous, up to 60 Amps @ 300 VA for short durations. It has a unique flat power curve from 4 to 30 Amps that insures maximum compliance voltage to load at all times. Three currents in parallel provide up to 180 Amps @ 900 VA for instantaneous tests. With a maximum compliance voltage of 50 Volts per phase, with just two channels in series provides 100 Volts of compliance voltage to test high impedance relays.

Each voltage channel can provide variable outputs of 0- 30/150/ 300 Volts at 150 VA of output power, and has a unique flat power curve from 30 to 150 Volts insuring maximum output power to the load at all times. With the voltage channel converted to current, a three channel unit can provide 6 currents for testing three phase current differential relays, including harmonic restraint transformer differential relays.

Using the Ethernet ports, the SMRT36 is literally a “plug-and-play” unit, where voltage and current outputs can be seamlessly synchronized with other SMRT units outputs for testing more complex test applications such as back-to-back tests, or up to 30 phase current test applications.

FEATURES AND BENEFITS

Constant Power Output – New higher powered Voltage-Current amplifiers. The current amplifier delivers maximum compliance voltage to the load constantly during the test, and range changing is done automatically under load. This insures better test results, and saves time by not having to turn the outputs off to change ranges. Constant power output in many cases eliminates the need to parallel or series current channels together to test high burden relays.

High Output Current – Provides up to 30 Amps at 200 VA per phase continuous, or up to 60 Amperes at 300 VA with a 1.5 second duty cycle. The three current amplifiers can be paralleled to provide a maximum of 180 Amperes at 900 VA, for testing all instantaneous overcurrent relays.

New PowerV™ Voltage Amplifier High Power Output – The SMRT provides a new higher VA power output on the voltage channel at the lower critical test voltages (from 30 to 150 Volts). Customers who want to test a panel of relays at one time find it impossible using lower VA rated voltage.

Convertible Voltage Channels – With a 3 channel SMRT36 unit, convertible channels in conjunction with the three main current channels, provides 6 currents for testing three phase current differential relays. With all six currents in parallel the unit can provide a maximum single phase output of 225 Amperes for short durations.

High resolution and accuracy – Metered outputs provides extremely high accuracy needed for testing a wide variety of devices. With metered values, what you see is what you get.

Steady-State and Dynamic testing capability – The SMRT36 provides, either through manual control or computer control, both steady-state and dynamic testing of protective relays. This includes programmable waveforms with dc offset and harmonics.

Output current and voltage sine waves are generated digitally – Outputs do not vary with sudden changes in input voltage or frequency, which increases test accuracy and reduces testing time.

Modular design – Output modules plug-in and out easily for system re-configuration and maintenance.

Built-in Transducer Testing Capability – The SMRT36P incorporates high accuracy amplifiers, an optional transducer DC input and test algorithms to test transducers easily and effectively.

Digital binary inputs and outputs – The programmable binary inputs, and programmable outputs provide timing and logic operations in real-time with the output voltage and currents. Binary Inputs can be programmed, using Boolean logic, for more complex power system simulations. This provides a low cost, closed loop, power system simulator.

Circuit breaker simulator – Binary outputs provide programmable normally closed and normally open contacts to simulate circuit breaker operation for testing reclosing relays. Sequence of operation, timing, and lockout are easily tested.

Performs transient tests – Perform acceptance or troubleshooting tests by replaying digitally recorded faults or EMTP/ATP simulations in the IEEE- C37.111, COMTRADE Standard format.

Perform End-to-End tests – Using AVTS software and a portable GPS satellite receiver, the SMRT performs satellite-synchronized end-to-end dynamic multi-state or playback transient COMTRADE files either for commissioning or troubleshooting tests.

Wide-ranging output frequency – The output frequency of the current and voltage channels can be set for any frequency from dc to 1 kHz. Popular test frequencies such as 16.66, 25, 33, 50, 60, 100,120, 125, 150, 180, 250, 300 and 400 Hz are easily set and controlled. Multi-purpose test system saves time and money.

USB 2.0 interface port – The USB port provides a PC interface for automated control of the SMRT unit. Also provides secure isolation when testing IEC 61850 devices (for customers who require secure isolation from their IEC 61850 substation bus).

Three Ethernet ports – PC/OUT Ethernet Port is the primary PC connection port. The IN/IEC61850 Ethernet Port provides interface to multiple SMRT units, and may be used to connect to the IEC 61850 substation bus. The OUT Ethernet Port is primarily used to interconnect multiple SMRT units together for synchronous multi-unit operation. The STVI PoE (Power over Ethernet) port and is used to connect to the STVI.

Bluetooth – Optional Bluetooth provides more flexibility. A wireless interface between the PC and SMRT, in conjunction with the SMRT IEC 61850 Ethernet port, provides the isolation required for a secure substation access interface between the SMRT and the IEC 61850 substation network.

Open communication architecture – Use with third party software for more flexible automated control.

Immediate error indication – Audible and visual alarms indicate when amplitude or waveforms of the outputs are in error.

Optional Transducer Testing Capability – This optional hardware feature (see Ordering Information) provides transducer DC Inputs to test transducers easily and effectively. The STVI software is designed to automatically recognize the Transducer DC Inputs, and thus provide the Transducer Test Screen when selected. AVTS software comes standard with Transducer Test Modules, which will provide automatic transducer test capability in conjunction with the optional hardware.

SMRT36 RELAY TESTER

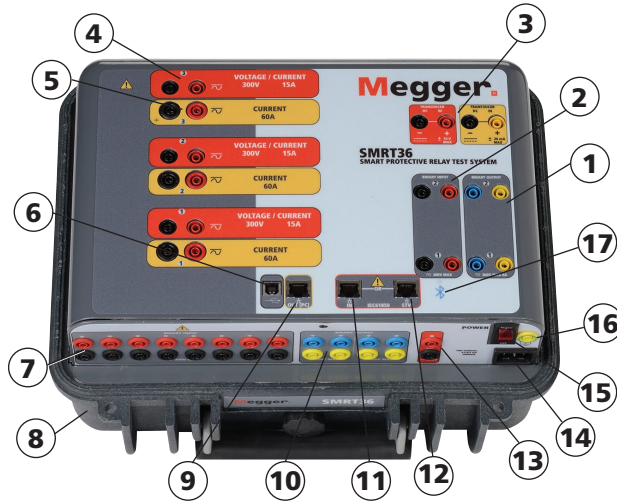

1. **Binary Outputs 1 and 2:** Rated for 300 V at 8 Amps.
2. **Binary Inputs 1 and 2:** Rated 5 to 300 V AC/DC.
3. **Transducer Input:** (Optional) DC voltage and DC milliamp input terminals.
4. **Voltage Outputs:** Up to 3 channels 300 V at 150 VA, convertible to currents 15 A at 120 VA per phase.
5. **Current Outputs:** Up to 3 channels 60 Amps at 300 VA per phase. Up 180 Amps at 900 VA single phase.
6. **USB 2.0 Interface:** Communication and control port.
7. **Additional Binary Inputs:** Provides 8 additional monitor circuits.
8. **Rugged Case:** Fiberglass reinforced plastic.
9. **PC/OUT:** Ethernet Port is the primary PC connection port. Ethernet Port used to chain multiple SMRT units together for synchronous multi-unit operation.
10. **Additional Binary Outputs:** Adds 4 outputs. Binary Outputs 3 and 4 are rated for 300 V AC/DC, 8 amperes. Binary Outputs 5 and 6 are high speed and have an AC/DC voltage rating of 400 volts peak, 1 ampere.
11. **IN/61850:** This port may also be used for connecting to the IEC 61850 substation bus for testing IEC 61850 devices.
12. **STVI:** Ethernet Port is a PoE (Power over Ethernet) port and is used to connect to the STVI for manual control.
13. **Battery Simulator:** Variable 5 to 250 Volts DC output at 100 Watts (4 amperes maximum).
14. **Incoming Power/Line Cord Socket:** 100 to 240 V, 50/60 Hz.
15. **POWER ON/OFF Switch:** Illuminates when power is on.
16. **Protective Earth Ground Jack.**
17. **Bluetooth:** Bluetooth® provides wireless control.

APPLICATIONS SELECTION GUIDE

Protective Relays by IEEE Device #		SMRT36 Single Channel	SMRT36 Two Channels	SMRT36 Three Channels
2	Time Delay	■	■	■
21	Distance Single Phase	■	■	■
21	Distance Three Phase Open Delta		■	■
21	Distance Three Phase wye			■
24	Volts/Hz	■	■	■
25	Synchronizing		■	■
27/59	Under/Over Voltage	■	■	■
32	Directional Power Single Phase	■	■	■
32	Directional Power Three Phase (Open Delta)		■	■
37/76	DC Under/Over Voltage/Current	■	■	■
40	Loss of Field	■	■	■
46	Phase Balance Current	■	■	■
46N	Negative Sequence Overcurrent	■	■	■
47	Phase Sequence Voltage (Open Delta)		■	■
50	Instantaneous Overcurrent	Up to 75 Amps	Up to 150 Amps	Up to 225 Amps
51	Time Delay Overcurrent	Up to 35 Amps	Up to 70 Amps	Up to 105 Amps
55	Power Factor	■	■	■
60	Voltage/Current Balance (Open Delta)	Single Phase	■	■
67	Directional Overcurrent	■	■	■
67N	Ground Directional Overcurrent	■	■	■
78	Out of Step	■	■	■
79	Reclosing	■	■	■
81	Frequency	■	■	■
85	Carrier or Pilot Wire	■	■	■
87	Differential	■	■	■
91	Voltage Directional (Open Delta)		■	■
92	Voltage and Power Directional (Open Delta)		■	■
94	Tripping	■	■	■

SPECIFICATIONS¹ INPUT POWER

The input voltage rating varies depending upon the style number. Universal units, the input voltage may be from 100 to 240 VAC, ± 10%, 50/60 Hertz. CE Marked units, the input voltage may be from 220 to 240 VAC, ± 10%, 50/60 Hertz. Total maximum output power will be limited for CE marked units. Input current required varies with the number of output modules in use, load, and input voltage value. With three VIGENS, the maximum input power is 1800VA.

Outputs

All outputs are independent from sudden changes in mains voltage and frequency, and are regulated so changes in load impedance do not affect the output. All amplifier outputs are isolated or floating. The SMRT units can be ordered with the amplifier common returns tied to chassis ground as an option.

Output Current Sources

The SMRT36 with three VIGEN modules can provide up to six current sources; three high current/high power, and three convertible channels providing lower current/high power. The per channel output current and power ratings are specified in AC rms values and peak power ratings.

Output Current	Power	Max V/Duty Cycle
1 Ampere	15 VA	15.0 Vrms Continuous
4 Amperes	200 VA (282 peak)	50.0 Vrms Continuous
15 Amperes	200 VA (282 peak)	13.4 Vrms Continuous
30 Amperes	200 VA (282 peak)	6.67 Vrms Continuous
60 Amperes	300 VA (424 peak)	5.00 Vrms 1.5 Sec
DC 200 Watts		

With three currents in parallel:

Output Current	Power	Max V/Duty Cycle
12 Amperes	600 VA (848 peak)	50.0 Vrms Continuous
45 Amperes	600 VA (848 peak)	13.4 Vrms Continuous
90 Amperes	600 VA (848 peak)	6.67 Vrms Continuous
180 Amperes	900 VA (1272 peak)	5.00 Vrms 1.5

With two currents in series:

The compliance voltage doubles to provide 4.0 Amperes at 100 Volts rms.

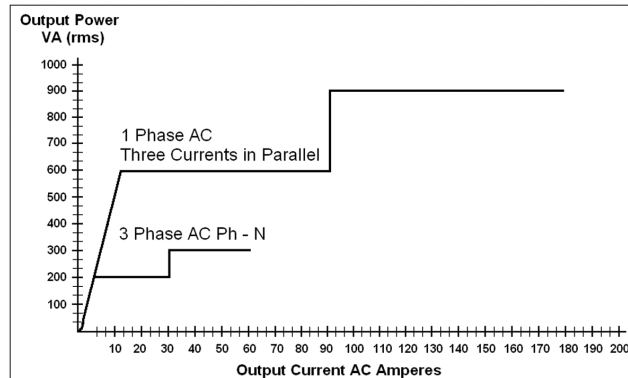

Current Amplifier Output Power Curve

Current Amplifier - Extended Power Range

The SMRT current amplifier provides a unique flat power curve from 4 to 30 Amperes per phase to permit testing of electromechanical high impedance relays, and other high burden applications, with an extended operating range up to 60 Amperes at 300 VA rms.

AC Voltage Output

Outputs are rated with the following Ranges:

Output Volts	Power	Max I
30 Volts	150 VA	5 Amps
150 Volts	150 VA	Variable ²
300 Volts	150 VA	0.5 Amps
DC 150 Watts		

Duty Cycle: Continuous

With two voltages in series

The output voltage and power doubles to provide 600 volts at 300 VA.

“PowerV™” Voltage Amplifier - Extended Power Range

The SMRT voltage amplifier provides a flat power curve from 30 to 150 Volts in the 150V range to permit testing of high current applications such as panel testing.

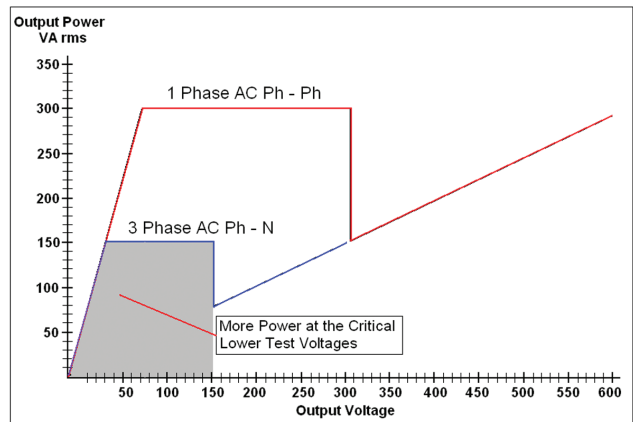

“PowerV” Voltage Amplifier Output Power Curves

Voltage Amplifier in Current Mode:

The voltage amplifier is convertible to a current source with the following output capability. Output power ratings are specified in rms values and peak power ratings.

Output Current	Power	Max V	Duty Cycle
5 Amperes	150 VA (212 peak)	30.0 Vrms	Continuous
15 Amperes	120 VA	8.0 Vrms	1.5 Sec

Phase Angle

Ranges: 0.00 to 359.99 degrees, Counter Clock Wise, or Clock Wise rotation, or 0.00 to ±180.00 degrees

Accuracy: ±0.02° typical, ±0.25° max at 50/60 Hz

Frequency

The output modules provide a variable frequency output with the following ranges and accuracy.

Ranges

DC

0.001 to 1000.000 Hz

Output amplifiers can provide transient signals with a range of DC to 10 kHz for transient playback using COMTRADE files.

Resolution*: .0001/.001 Hz

Frequency Accuracy:

2.5 ppm typical

25 ppm 0° to 50° C, at 50/60 Hz Maximum

¹ Megger reserves the right to change product specifications at any time.

² PowerV™ voltage amplifier output current varies depending on the voltage setting on the 150 Volt range, see curve.

Total Harmonic Distortion

Less than 0.1% typical, 2% maximum at 50/60 Hz

Timer

The Timer-Monitor Input is designed to monitor and time-tag inputs, like a sequence of events recorder. In addition, the binary input controls enable the user to perform logic AND/OR functions, and conditionally control the binary output relay to simulate circuit breaker, trip, reclose and carrier control operation in real-time. The Timer function displays in Seconds or Cycles, with the following range and resolution:

Seconds: 0.0001 to 99999.9

(Auto Ranging)

Cycles: 0.01 to 99999.9

(Auto Ranging)

Accuracy: $\pm 0.001\%$ of reading, typical. ± 2 least significant digit, $\pm 0.005\%$ of reading from 0 to 50° C maximum

Binary Input – Start/Stop/Monitor Gate

To monitor operation of relay contacts or trip SCR, continuity light is provided for the input gate. Upon sensing continuity the lamp will glow. In addition to serving as wet/dry contacts the Binary Inputs may be programmed to trigger binary output sequence(s).

Input Rating: up to 300 V AC/DC

Binary Output Relays

SMRT36 has independent, galvanically isolated, output relay contacts to accurately simulate relay or power system inputs to completely test relays removed from the power system. The binary output simulates normally open / normally closed contacts for testing breaker failure schemes. The binary output can be configured to change state based on binary input logic.

High Current Output Relays: The first two VIGEN Modules have 1 each and the P option add 2 more.

AC Rating: 400 V max., I_{max}: 8 amps, 2000 VA max.

DC Rating: 300 V max., I_{max}: 8 amps, 80 W

Response Time: <10ms

High Speed Output Relays: SMRT36 P Option adds 2

AC/DC Rating: 400 V peak, I_{max}: 1 amp

Response Time: <1ms typical

Battery Simulator

The SMRT36 with the P (Plus) option includes a battery simulator with a variable DC output voltage ranging from 5 to 250 Volts at 100 Watts, 4 Amps max, providing capability to power up relays with redundant power supplies. Voltage output is controlled via the Smart Touch-View Interface, or through AVTS software. The SMRT36 with the N option does not include a battery simulator.

Waveform Generation

Each output channel can generate a variety of output waveforms such as: DC; sine wave; sine wave with percent harmonics at various phase angles; half waves; square waves with variable duty cycles; exponential decays; periodic transient waveforms from digital fault recorders, relays with waveform recording capability or EMTP/ATP programs, which conform to the IEEE C37.111 COMTRADE standard format.

Metering

Measured output quantities such as AC Amperes, AC Volts, DC Volts or DC Amperes, and Time may be simultaneously displayed on the large, color TFT LCD touch screen. The AC and DC outputs display the approximate voltage/current output prior to initiation of the outputs. All accuracies stated are from 10 to 100% of the range at 50/60Hz.

AC Voltage Amplitude

Accuracy: $\pm 0.05\%$ reading + 0.02 % range typical, $\pm 0.15\%$ reading + 0.05 % range maximum

Resolution: .01

Measurements: AC RMS

Ranges: 30, 150, 300V

AC Current Amplitude

Accuracy: $\pm 0.05\%$ reading + 0.02 % range typical, $\pm 0.15\%$ reading + 0.05 % range maximum

Resolution: .001/.01

Measurements: AC RMS

Ranges: 30, 60A

DC Voltage Amplitude

Accuracy: 0.1% range typical, 0.25% range maximum

Resolution: .01

Measurements: RMS

Ranges: 30, 150, 300V

DC Current Amplitude

Accuracy: $\pm 0.05\%$ reading + 0.02 % range typical, $\pm 0.15\%$ reading + 0.05 % range maximum

Resolution: .001/.01

Measurements: RMS

Ranges: 30A

Convertible Source in AC Current Mode

Accuracy: $\pm 0.05\%$ reading + 0.02 % range typical, $\pm 0.15\%$ reading + 0.05 % range or ± 12.5 mA whichever is greater

Resolution: .001

Measurements: AC RMS

Range: 5, 15A

DC IN Inputs (Optional Transducer Feature)**DC IN Volts Range: 0 to ±10 V DC**

Accuracy: ±0.001% reading + 0.005% range Typical
±0.003% reading + 0.02% range Max

Resolution: .001

Measurements: Average

DC IN Amperes Range: 0 to ±1 mA DC

4 to ±20 mA DC

Accuracy: ±0.001% reading + 0.005% range Typical
±0.003% reading + 0.02% range Max

Resolution: .001

Measurements: Average

Environmental

Operating Temperature: 32 to 122° F (0 to 50° C)

Storage Temperature: -40 to 158° F (-40 to 70° C)

Relative Humidity: 5 - 90% RH, Non-condensing

Unit Enclosure

The SMRT unit comes housed in a rugged, virtually indestructible, lightweight and ergonomic enclosure. It features a large oversized rubber cushioned handle, and removable lid for use in tight spaces.

Dimensions**With the lid on:**

14.2 W x 7.6 H x 12.0 D in.
(360 W x 194 H x 305 D mm)

With the lid off:

14.2 W x 7.2 H x 12.0 D in.
(360 W x 180 H x 305 D mm)

IEC Enclosure Rating: IP30

Weight

With the transit lid on: 27.9 lb. (12.55 kg)

With the transit lid off: 25.8 lb. (11.6 kg)

Conformance Standards

Safety: EN 61010-1

Shock: MIL-PRF-28800F (30 g/11ms half-sine)
IEC 60068-2-27 (15 g/11 ms half-sine)

Vibration: MIL-PRF-28800F (10-500 Hz, 2.05 g rms)
IEC 60068-2-6 (10-150 Hz, 2 g)

Transit Drop: MIL-PRF-28800F (10 drops, 46 cm), ISTA 1A

Electromagnetic Compatibility

Emissions: EN 61326-2-1, EN 61000-3-2/3,
FCC Subpart B of Part 15 Class A

Immunity: EN 61000-4-2/3/4/5/6/8/11

Protection

Voltage outputs are protected from short circuits and thermally protected against prolonged overloads. Current outputs are protected against open circuits and thermally protected against prolonged overloads.

Communication Interfaces

Ethernet (2)

USB 2.0

Bluetooth (optional)

ORDERING INFORMATION

STYLE NUMBER IDENTIFICATION

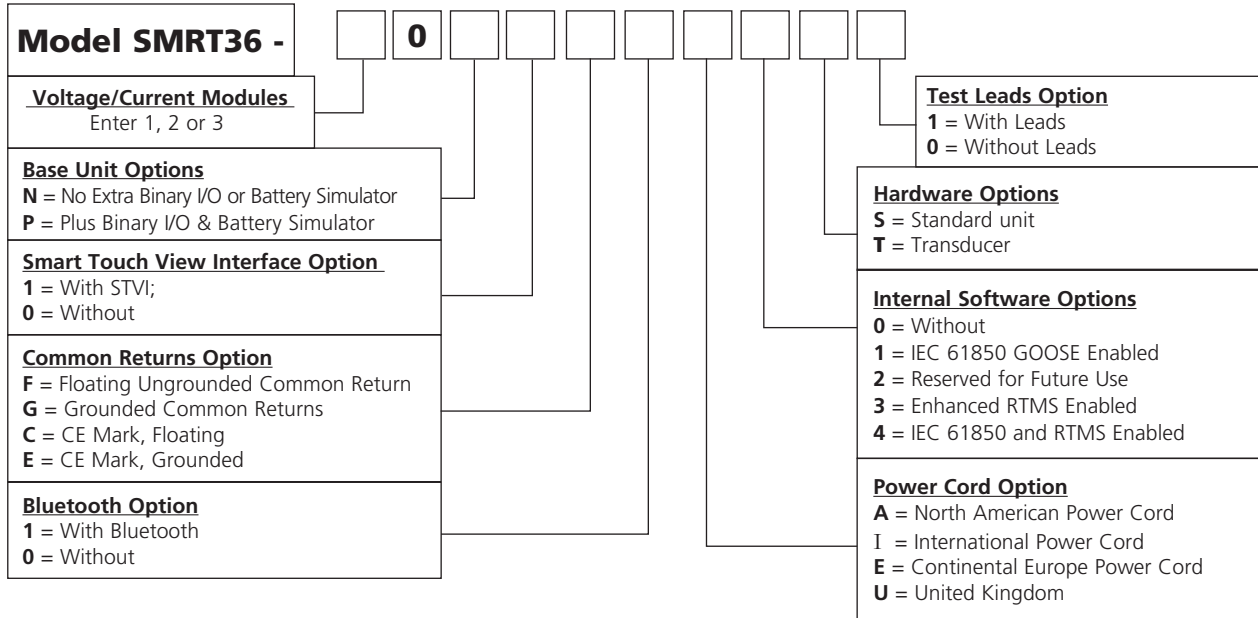

DESCRIPTIONS OF HARDWARE OPTIONS

This modular system lets you select the testing capabilities you need now and expand as testing requirements change. Customize the system by adding the number of Voltage-Current amplifier (VIGEN) modules (1, 2, or 3), selecting floating or grounded common returns, power cord, IEC 61850 test capable, standard hardware or transducer feature added, and with or without test leads. See the following descriptions.

Voltage/Current Module: The SMRT36 unit can have 1, 2 or 3 voltage/current modules. Enter the number of desired modules 1, 2 or 3.

Smart Touch View Interface Option: Enter the number **1** for the unit to come with the STVI, or enter the number **0** for without.

Common Returns Option: The floating returns option provides independent isolated return terminals for each output channel. The grounded common returns option, the return terminals are interconnected internally and connected to chassis ground. The CE Mark, C and E units have been certified to the IEC standards for EMC for both the grounded and floating options. The F and G units are designed to operate in countries which do not require the CE mark.

Power Cord Option Customers can choose which type of power cord they want the unit to come with.

- **A** option – NEMA 5-15 to IEC60320 C13 connectors, UL & CSA approved for countries with NEMA outlets.

- **I** option - International color coded wires (light blue, brown and green with yellow stripe) insulation jacket stripped ready for male connector with IEC 60320 C13 connector.CE marked.
- **E** option - CEE 7/7 "Schuko" plug to IEC 60320 C13 connector is CE marked.
- **U** option – United Kingdom power cord with IEC 60320 C13 connector, and 13 Amp fuse. BS 1363 / CE Marked.

Internal Software Options: The SMRT36 in conjunction with the optional Megger GOOSE Configurator (MGC) software can be used in the testing or commissioning of IEC 61850 compliant devices. In order for the SMRT36 to be able to subscribe as well as publish GOOSE messages, the IEC 61850 feature needs to be enabled . Enter the number **1** for the unit to come with the IEC 61850 option enabled¹. The number **2** is reserved for future use. Enter the number **3** to enable additional RTMS software features such as the Synchronizer and Frequency test. Enter the number **4** to have both IEC 61850 and RTMS software features enabled. Enter **0** for the unit without internal software options enabled

Hardware Options: **S**= Standard unit. **T**= With Transducer test capability enabled (requires 3 channel configuration). When equipped with the Transducer test feature the total number of binary inputs and outputs are reduced by 1.

Test Leads Option: Enter the number **1** for the unit to come with Test Leads. Enter **0** for the unit without Test Leads.

¹Requires the Optional Megger GOOSE Configurator software to program the unit to subscribe and publish GOOSE messages, see Software Options for part numbers and descriptions.

DESCRIPTION OF SOFTWARE OPTIONS

#	Included Software	Part Number
1	AVTS Basic with RTMS Application Software	84978
Optional Software		
1	AVTS Basic with IEC 61850 Megger GOOSE Configurator, and RTMS Application Software	1002-103
2	AVTS Advanced with RTMS Application Software	81570
3	AVTS Advanced Test with IEC 61850 Megger GOOSE Configurator, and RTMS Application Software	1002-106
4	AVTS Professional with RTMS Application Software	81571
5	AVTS Professional Test with IEC 61850 Megger GOOSE Configurator, and RTMS Application S/W	1002-102

Descriptions of Software

Included Software – Every unit comes with **AVTS Basic**, and the PC version of the **RTMS software**

AVTS Basic with RTMS software (PC Version)
Part Number: 84978

AVTS Basic includes Online Vector, Online Ramp and Online Click-On-Fault controls, with the ability to import, execute automatically determine the reach characteristics of single or multi-zone Distance relays using shot for single point tests, or Ramp, Pulse Ramp, or Binary Search tools along user defined search lines. Basic also includes enhanced Relay Test Wizards for; Overcurrent, Differential, Voltage, Frequency and Distance relays. AVTS Basic does not require a software license key to run.

The powerful RTMS software can be run directly from a PC providing both manual and automatic test capabilities. See the RTMS datasheet for more detailed descriptions of test features and capabilities.

Additional Optional Software

AVTS Advanced with RTMS software
Part Number: 81570

AVTS Advanced includes all of the features of AVTS Basic in addition to the powerful Test Editor and test editor tools, which includes the Dynamic Control (with dynamic end-to-end test capability, and Recorder features) for developing sequential tests for virtually any function or measuring element within digital relays. In addition, it also includes Modbus communications for automatic download of settings, SS1 File Converter for ASPEN® and CAPE® dynamic test files, End-to-End DFR Playback test capability and basic programming Tools for creating and editing test modules. Software comes with a USB software license key to run on any PC. Test files created in Advanced Test can be used with any PC running AVTS Basic without a software license key.

AVTS Professional with RTMS software
Part Number: 81571

Professional Test includes all of the features of AVTS Advanced Test version plus the following additional specialized test tools. The DFR Waveform Viewer and Playback tools are used for viewing and analyzing IEEE C37.111 COMTRADE Standard files from digital fault recorders and microprocessor based relays. The DFR Waveform Viewer includes tools to recreate the analog and digital channels for playback into protective relays for troubleshooting or evaluation. It includes the capability to extend the predefault data as well as start the timer associated with the event to time relay operation. These

playback test files can also be used in end-to-end tests to recreate the transient event and evaluate the protection scheme. Test files created in Professional can be used with Advanced Test and Basic. Also included is the One-Touch Test Editor Control Tool for fully automatic testing of microprocessor based relays using VB script files to automatically download relay settings, and automatically test all the measuring elements within the relay based upon those settings. The Waveform Digitizer feature is also included in the Professional Test version of AVTS. It provides tools to create digital time curves for virtually any electromechanical relay time curve (that do not fit a time curve algorithm). It can even be used for digitizing scanned waveforms from a light-beam chart recorder. Software comes with a USB software license key to run on any PC. Test files created in Professional Test can be used with any PC running AVTS Basic without a software license key.

IEC 61850 Megger GOOSE Configurator Software
(See Table for Part Numbers)







The Megger GOOSE Configurator (MGC) provides easy to use tools for testing relays and substations using the IEC 61850 protocol. It is an optional software tool available with Basic, Advanced or Professional versions of AVTS Software; see Descriptions of Software Options above. The Configurator provides relay test engineers and technicians the capability to import parameters from configuration files in the Substation Configuration Language (SCL) format, and/or capture GOOSE messages directly from the substation bus. All imported SCL GOOSE messages will be unconfirmed messages. Only captured messages are confirmed messages due to the Capture feature of the MGC. Use the MGC Merge feature to compare imported SCL and captured GOOSE messages to verify all GOOSE messages needed to perform tests. Use them to configure the SMRT to subscribe to preselected GOOSE messages by assigning the data attributes to the appropriate binary inputs of the SMRT. Use the configurator to assign the appropriate binary outputs of the SMRT to publish GOOSE messages simulating circuit breaker status. After the appropriate assignments of binary inputs and outputs have been made, the test file can be saved for reuse. This provides both manual and automatic testing of the relay using either the RTMS or AVTS software. Use standard test modules in AVTS to perform automatic tests. Use the Dynamic Control in AVTS Advanced or Professional to perform high speed trip and reclose tests, or use to perform interoperability high-speed shared I/O tests between multiple IED's. The MGC provides mappings of Boolean and Bit Strings and/or simulation of STRuct, Integer/Unsigned, Float and UTC datasets.

DESCRIPTION

Included Standard Accessories	Part Number
Power Cord - Depending on the style number, the unit will come with one of the following,	
Line cord, North American	620000
Line cord, Continental Europe with CEE 7/7 Schuko Plug	50425
Line cord, International color coded wire	15065
Line cord, United Kingdom	90002-989
Ethernet cable for interconnection to PC, 210cm (7 ft.) long (Qty. 1 ea)	90003-684
Instruction manual CD	80989

Table of Accessories

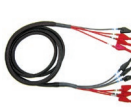
Accessories are supplied with the selection of the Test Leads Option, and/or the Binary Input / Output / Battery Simulator Option, and/or the STVI Option. With the Test Leads Option the number and type of leads varies depending on the number of channels ordered. If desired, Test Leads and Accessories can be ordered individually, see description and part numbers below.

	Optional Accessories Descriptions	STVI, or Binary I/O Bat SIM, or Test Leads Options	One (1) Voltage Current Module	Two (2) Voltage Current Modules	Three (3) Voltage Current Modules	Binary I/O, Battery Simulator Option
	Accessory Carry Case: Use to carry power cord, Ethernet cable, Optional STVI and test leads.	Qty. 1 ea. Part No. 2003-725				
	Sleeved Pair of Test Leads: Keeps the test leads in pairs and from getting entangled. Sleeved Test Leads, one red, one black, 200 cm (78.7") long, 600 V, 32 Amperes CAT II.		Qty. 3 pr. Part No. 2001-394	Qty. 6 pr. Part No. 2001-394	Qty. 2 pr. Part No. 2001-394	Qty. 3 pr. Part No. 2001-394
	Cable/Spade Lug Adapter (Small): Small lug fit most new relay small terminal blocks. Lug adapter, red, 4.1 mm, use with test leads up to 1000 V/ 20 Amps CAT II.		Qty. 3 ea. Part No. 684004	Qty. 6 ea. Part No. 684004	Qty. 12ea. Part No. 684004	Qty. 3 ea. Part No. 684004
	Lug adapter, black, 4.1 mm, use with test leads up to 1000 V/ 20 Amps CAT II.		Qty. 3 ea. Part Number 684005	Qty. 6 ea. Part Number 684005	Qty. 12ea. Part Number 684005	Qty. 3 ea. Part Number 684005
	Jumper Lead: Used to common returns together on units with floating ground returns, or parallel of current channels. Jumper lead, black, 12.5 cm (5") long, use with voltage / current outputs, 600 V, 32 Amps CAT II.			Qty. 2 ea. Part Number 2001-573	Qty. 4 ea. Part Number 2001-573	
	Sleeved Combination Voltage Test Leads: Keeps the test leads from getting entangled. Three common leads connect to the test set, which are interconnected down to one black common to connect to the relay under test. Sleeved Three Phase Test Leads, three red and black, 200 cm (78.7") long, 600 V, 32 Amperes CAT II.				Qty. 1 ea. Part Number 2001-395	
	Sleeved Combination Current Test Leads: Keeps the test leads from getting entangled. Three pairs of leads connect to the test set, with three pairs to connect to the relay under test. Sleeved Three Phase Test Leads, three red and black, 200 cm (78.7") long, 600 V, 32 Amperes CAT II.				Qty. 1 ea. Part Number 2001-396	

Note that the sleeved combination leads only come with the three module configuration.



Deluxe Test Leads and Accessories Kit Part No.: 1001-619

The Test Leads and Test Lead Accessories are an option. Test leads and accessories can be ordered with the unit, or later as a kit. The Deluxe Test Leads and Accessories Kit includes sleeved pairs of leads for use with the extra binary inputs/outputs/battery simulator option, as well as the three phase sleeved combination leads for voltage and current channels. The following test leads and test lead accessories are included in the Deluxe Test Leads and Accessories Kit in quantities shown.

Description	Part No.
Sleeved Combination Voltage Test Leads: Keeps the test leads from getting entangled. Sleeved Three Phase Test Leads, three red and black, 200 cm (78.7") long, 600 V, 32 Amperes CAT II (Qty. 1 ea)	2001-395
Sleeved Combination Current Test Leads: Keeps the test leads from getting entangled. Sleeved Three Phase Test Leads, three red and black, 200 cm (78.7") long, 600 V, 32 Amperes CAT II (Qty. 1 ea)	2001-396
Sleeved Pair Test Leads, one red, one black, 200 cm (78.7") long, 600 V, 32 Amperes CAT II (Qty. 5 pair)	2001-394
Jumper lead, black, 12.5 cm (5") long, use with voltage / current outputs, 600 V, 32 Amps CAT II (Qty. 4 ea.)	2001-573
Cable/Spade Lug Adapter (Small): Small lug fits most new relay small terminal blocks. Lug adapter, red, 4.1 mm, use with test leads up to 1000 V / 20 Amps CAT II (Qty. 15 ea.)	684004
Lug adapter, black, 4.1 mm, use with test leads up to 1000 V / 20 Amps CAT II (Qty. 15 ea.)	684005
Accessory Case, black, used to carry test leads and/or STVI (Qty. 1 ea.)	2003-725

Additional Accessories (Not Included in the SMRT36 Test Leads Option or Deluxe Lead Kit) Additional Optional Test Leads and Accessories can be ordered individually, see description and part numbers below. The following accessories and part numbers are in quantities of 1 each. Order the appropriate number required.	
Individual (non-sleeved) Test Leads: Excellent for widely separated individual terminal test connections.	
	
Test lead, red, use with voltage/current output, or binary I/O, 200 cm long (78.7") 600 V/32 Amps CAT II.	620143
Test Lead, black, use with voltage/current output, or binary I/O, 200 cm long (78.7") 600 V/32 Amps CAT II.	620144

Individual (non-sleeved) Extra Long Test Leads: Excellent for widely separated individual terminal test connections.	
	
Extra long test lead, black, use with voltage/current output, or binary I/O, 360 cm long (12 ft) 600 V/32 Amps CAT II.	2003-172
Extra long test lead, red, use with voltage/current output, or binary I/O, 360 cm long (12 ft) 600 V/32 Amps CAT II.	2003-173





Description	Part No.
Cable/Spade Lug Adapter (Large): Large spade lug fits older relay terminal blocks, or STATES® Company FTP10 or FTP14 Test paddles, ABB or General Electric test plugs with screw down terminals.	
	
Lug adapter, red, 6.2 mm, use with test leads up to 1000 V/20 Amps CAT II.	684002
Lug adapter, black, 6.2 mm, use with test leads up to 1000 V/20 Amps CAT II.	684003
Alligator/Crocodile Clip: Excellent for test connections to terminal screws and pins where spade lugs cannot be used.	
	
Alligator clip, red, use with test leads up to 1000 V/32 Amps CAT III.	684006
Alligator clip, black, use with test leads up to 1000 V/32 Amps CAT III.	684007

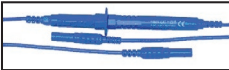

Flexible Test Lead Adapter: Use with rail-mounted terminals or screw clamp connections where spade lugs and crocodile/alligator clips cannot be used.	
	
Flexible test lead adapter, black, 1.8 mm male pin, use with test leads up to 1000 V/32 Amps CAT III.	90001-845

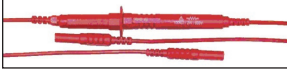
Flexible Test Lead Adapter with Retractable Insulated Sleeve: Use for connection to old style non-safety sockets with retractable protective sleeve on one end.	
	
Retractable sleeve test lead, red, 50 cm (20") long, use with test leads up to 600 V/32 Amperes CAT II.	90001-843
Retractable sleeve test lead, black, 50 cm (20") long, use with test leads up to 600 V/32 Amperes CAT II.	90001-844

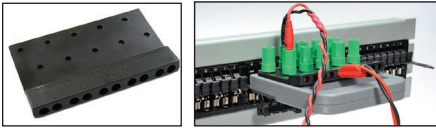
In-Line Fused Test Lead: Use with high speed binary outputs 5 or 6 ("P" Option) to protect for accidental switching of currents higher than 1 Amp.	
	
Test lead, blue, in-line 500 mA fuse protection, 200 cm long (78.7").	568026

In-Line Fused Test Lead: Use with ("P" Option) Battery Simulator output to protect for accidental connection to substation battery.	
	
Test lead, black, in-line 3.15 A fuse protection, 200 cm long (78.7").	568025

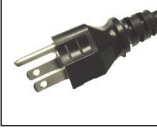
Description	Part No.
<p>In-Line Resistor Test Lead: Use with old solid state relays with “leaky” SCR trip gates.</p> 	
<p>Test lead, red, in-line 100 k Ohm resistor, use with test leads up to 1000 V/32 Amps CAT III.</p>	500395
<p>Parallel test lead adapter:</p> 	
<p>Used when paralleling up to three current test leads together to a common test point. Usually used when connecting to a test paddle (like the pictured States Company test paddle.)</p>	1002-286
<p>STATES® 10 Pole Test Paddle: Use with STATES FMS Test Switch or ABB FT-1 10 pole Test Switch.</p> 	
<p>Test paddle features knobs which also serve as insulated Ø 4 mm rigid socket accepting spring loaded Ø 4 mm plugs with rigged insulating sleeve, or retractable sleeve. Use with test leads up to 600 V, 32 Amperes CATII.</p>	V1TP10
<p>STATES® 10 Pole Test Paddle Attachment: Use with STATES V1TP10 Test Paddle.</p> 	
<p>Test paddle attachment provides an additional 10 insulated connection points for front connection, as well as the standard top connections for test leads. Adapter can provide convenient parallel test connections of test currents to two terminals at one time. Use with test leads up to 600 V, 32 Amperes CAT II.</p>	TPA10
<p>Transit Case</p> <p>Hard-Sided Transit Case: Includes custom designed foam inserts for the SMRT unit and accessory case. Transit case includes retractable handle, polyurethane wheels with stainless steel bearings, double-throw latches, fold-down handles, and stainless steel hardware and padlock protection, with O-ring seal making the case water-tight, with an IP 67 rating. Tested and certified to US Department of Defense Standards for impact, vibration, and low/high storage temperatures. The case is small, and weighs only 25 pounds (11.25 kg). With a three channel SMRT 36 it is light enough to check as luggage on commercial airliners.</p> 	
<p>Rugged, hard-sided transit case (1ea).</p>	1001-632

Description	Part No.
<p>Example Configurations</p> 	
<p>For customers in North America, Central America, Japan, Philippines, South Korea, Taiwan, Thailand, Venezuela, Virgin Islands, and other countries that use standard NEMA type power outlets of 100, 110, 115 or 120 volts at 50/60 Hz. could order a unit with the standard North American power cord. In this example the unit is a SMRT36 three phase unit, with the extra binary I/O and Battery Simulator, with the STVI1, without grounded common returns, no Bluetooth, no IEC61850, with the standard hardware, and with test leads.</p>	<p>The style number would be, SMRT36 – 30P1FOA051</p>
	
<p>For customers in Austria, Belgium, Finland, France, Germany, the Netherlands, Norway, Portugal, Spain, Sweden, Turkey, and other countries where the CEE 7 standard connector is used could order a unit with the Continental European Power Cord with CEE 7/7 Schuko plug. In this example the unit is a 3 phase unit, with the extra binary I/O and Battery Simulator, without the STVI1, with floating outputs, no Bluetooth, with IEC61850 enabled, with the standard hardware, and with test leads.</p>	<p>The style number would be, SMRT36-30P0FOE151</p>
	
<p>For customers in United Kingdom, Ireland, Anguilla, Cyprus, Dominica, Gambia, Gibraltar, Malta, Malaysia, Malawi, St. Lucia, St. Vincent, Zambia, and other countries where the UK standard connector is used could order a unit with the UK Power Cord. In this example the unit is a 3 channel unit, with the extra binary I/O and Battery Simulator, with the STVI-1, CE Marked 220-230 V input and floating commons, no Bluetooth, with IEC61850 enabled, with standard hardware, and with test leads.</p>	<p>The style number would be, SMRT36-30P1COU151</p>
<p>The final example is for countries that have more unique power connectors, which will require international color coded wires ready for appropriate male connectors to be installed like; Australia/New Zealand, Argentina, China, Demark, India, South Africa, Ireland, Israel, Russia, Switzerland, or the United Kingdom. These countries are more likely to order the unit with the international color coded power cord ready for mounting the appropriate male connector. In this example the unit is a 3 phase unit, with the extra binary I/O and Battery Simulator, with the STVI1, with the floating outputs, with Bluetooth, with IEC61850 enabled, with the standard hardware, and with test leads.</p>	<p>The style number would be, SMRT36 – 30P1F1151</p>

