

# SMRT410D

## Megger Multi-phase Relay Test System



- **Integrated Smart Touch View Interface™**
- **Multi-colored graphics with intuitive navigation**
- **Stand-alone operation, no PC required to operate**
- **High current output - 60 Amps at 300 VA per phase**
- **Flexible output design provides up to 10 currents**
- **Dynamic, Transient and GPS Satellite Synchronized End-to-End Testing Capability**
- **IEC 61850 Testing Capability**

### DESCRIPTION

The SMRT410D is a multipurpose, light-weight, field portable test set capable of testing a wide variety of electro-mechanical, solid-state and microprocessor-based protective relays, motor overload relays, and similar protective devices.

The unit can be operated either manually via the built-in touch-screen user interface, or placed under full computer control via the AVTS, Advanced Visual Testing Software, or the STVI-software running on a PC. In addition, with the open communication architecture, the unit can also be used with third-party software programs such as National Instruments LabVIEW™.

The built-in user interface, called the Smart Touch-View Interface™ (STVI), is Megger's second generation of automatic / semi-automatic manual user interface software. It incorporates a large, easy to read Full Color high resolution, high definition, TFT LCD touch-screen display, which displays metered values such as AC and DC Amperes, AC and DC Volts, and Time in both seconds and cycles. Depending on the type of test selected, other values may be displayed, such as Phase Angle, Frequency, Ohms, Watts, VA, or Power Factor.

### APPLICATION

The test system may be customized by adding the number of Voltage-Current, "VIGEN", modules needed for specific test applications, with a maximum of 5 channels. For example, the SMRT410D with three VIGEN Modules provides complete three-phase testing of three-phase impedance, directional power, negative sequence overcurrent and other devices that require a three-phase four-wire wye connected source.

Each current channel is rated for 30 Amps @ 200 VA continuous, and up to 60 Amps @ 300 VA for short durations. For testing relay panels or electromechanical relays, it has a unique flat power curve from 4 to 30 Amps that insures maximum compliance voltage to the load at all times.

With a maximum compliance voltage of 50 Volts per phase, two channels in series provide 100 Volts to test high impedance relays. Five currents in parallel provides test currents up to 20 Amperes (1000 VA) for testing ground overcurrent relays at high multiples of tap rating.

With only three currents in parallel it can provide up to 180 Amps at 900 VA for testing all instantaneous overcurrent relays.

Each voltage channel can provide variable outputs of 0- 30/150/ 300 Volts at 150 VA of output power. Automatic range changing is done on-the-fly and under load. For testing a panel of relays, or older electromechanical impedance relays, it has a unique flat power curve from 30 to 150 Volts insuring maximum output power to the load at all times.

With the voltage channels converted to currents, a three channel unit can provide 6 currents for testing three phase current differential relays, including harmonic restraint transformer differential relays. With 5 channels the unit can provide up to 10 currents for testing bus differential, or 9 currents for three-winding transformers, without having to move test leads.

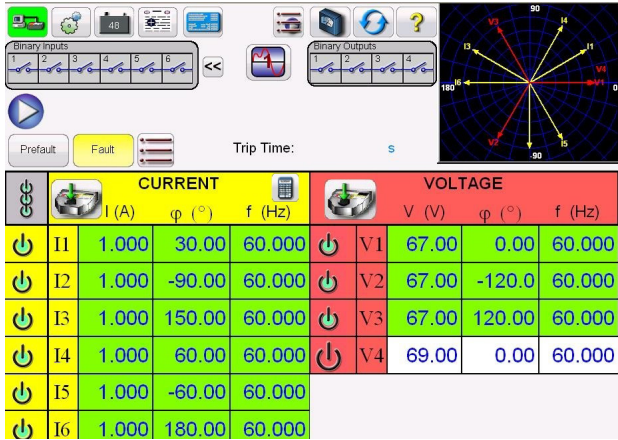

Figure 1 Advanced Manual Test Screen for a 5 Channel, 4 Voltages / 6 Currents Unit

## MANUAL OPERATION

The Smart Touch View Interface™ (STVI) touch screen allows the user to perform manual, steady-state and dynamic testing quickly and easily using the Manual or Sequencer test screens, as well as using built-in preset test routines for most popular relays. Ergonomically designed with the control knob, and the touch screen, the powerful STVI-software is extremely easy to use.

## DESCRIPTION

The most significant feature of the STVI software is its ability to provide the user with a very simple way to manually test, for both commissioning and maintenance, from the simple overcurrent relay to the most complex relays manufactured today. Manual operation is simplified through the use of a built-in computer operating system and the touch screen. The STVI eliminates the need for a computer when testing virtually all types of relays. Enhanced graphics, intuitive menu screens, and touch screen icon buttons are provided to quickly and easily select the desired test function.

## MANUAL TEST SCREEN

A vector graph indicates the relative phase angles of all the outputs, or the user can select to see the positive, negative, and zero sequence vectors displayed. The user may select to have all output amplitudes metered to provide real time verification of all of the selected outputs, or have setting values displayed. In the Manual Test Screen the user can set Prefault and Fault values. The user can toggle back and forth between the two values to monitor contact activity. To do a simple timing test the user can set Prefault time duration in seconds, and then press the Blue Play button. The Prefault values will be applied for the Prefault time, then change to the Fault

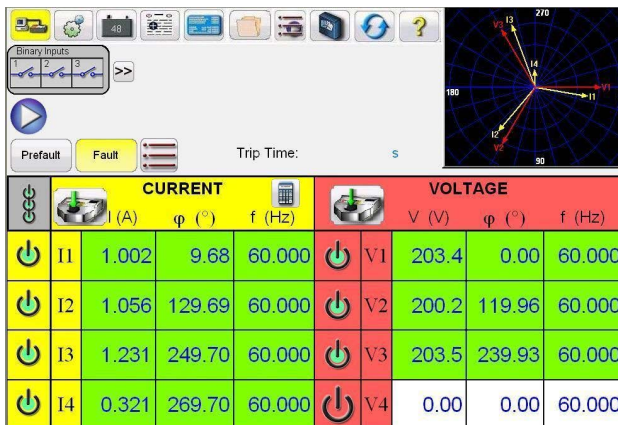

Figure 2 Color Accents when Selected Outputs are on (4 Channel unit shown)

values and start the Timer running. When the relay trips, it will stop the timer, and may turn selected outputs off depending on the user defined Auto-Off configuration. The test results may be saved to the internal memory to download later into a larger database for record keeping.

In the Advanced manual test screen, the user can define up to four waveforms, the default 1 (Fundamental), plus a Second (2), Third (3) and Fourth (4) Waveforms. All four waveforms will be summed together to create a harmonic waveform. Individual harmonic amplitudes and phase angles are easily adjusted. This feature is normally used when generating a second, third or fifth harmonics when testing harmonic restraint transformer differential or generator neutral protection relays.

## AUTO RAMP, PULSE RAMP AND BINARY SEARCH FEATURES

The STVI software may be used to automatically determine pickup or dropout of various types of relays. Pressing the Auto Ramp button presents three choices; Step Ramp, Pulse Ramp, and Pulse Ramp Binary Search.

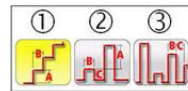

Figure 3 Step Ramp, Pulse Ramp and Pulse Ramp Binary Search Selection Bar

The first selection, Step Ramp, will ramp the output by applying a value and then wait a specific amount of time before incrementing. To automatically ramp output current the user will select the channel to be ramped, set Start and Stop Amplitudes, an Increment (A), and a Delay time in Cycles (B).

Pulse Ramp will start at user defined prefault condition, increment up or down returning to the prefault condition between each increment. Instead of Delay time the user sets the Pulse Cycles time, which applies the fault value to the relay for the specified time.

The user can select a 2nd, 3rd and 4th ramp if desired, changing the size of the increment with each ramp. This feature is most used when doing instantaneous pickup tests. The output current, or voltage, can be incremented in large steps getting to the pickup point quickly, and then reduce the size of the increment to zero-in on the pickup value. This reduces the test time, heating of the relay under test, and provides a very accurate test result. This feature is also used when testing multi zone distance relays using three phase voltage and currents. Set the Pulse Cycles duration just long enough for the intended zone to operate. If you are not sure exactly where the pickup value of the relay is, you can use the Pulse Ramp Binary Search feature.

## TIMING TEST FEATURE

Pressing the Time test button on the test menu list, the user is presented a menu of relays to test. Built-in timing tests are provided for a wide variety of protective relays, including Overcurrent, Voltage, and Frequency relays. To make it even easier and faster, the STVI-software has

ANSI, IEC, and IEEE Standards time curve algorithms built-in. The STVI-software also includes time curves and time curve algorithms for hundreds of specific relays. The user can select from a pull-down list of different manufacturers (20 different manufacturers and growing), then select the relay model number, and/or curve shape (inverse, very inverse, definite time etc.). The list includes relay manufacturer's digitized log-log, and semi-log, electromechanical relay time curves. Therefore, tests are conducted using the manufacturer's actual time curve. In the following example, the G.E. IAC-51B relay with a 1 Amp Tap and a number 2 Time Dial was selected.

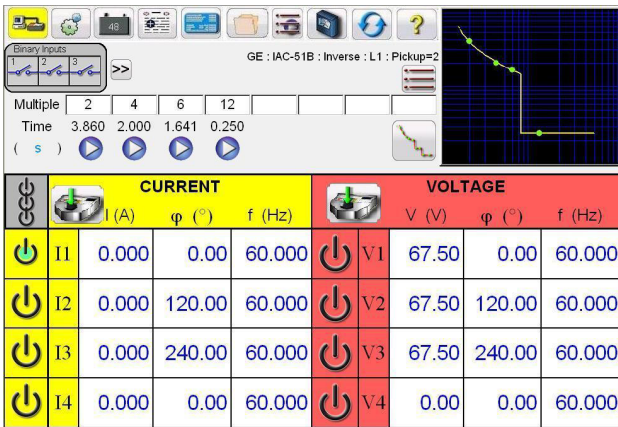

Figure 4 Timing G.E. IAC51B Overcurrent Relay (4 Channel unit shown)

By entering the appropriate values in the setting screen, when the timing test is conducted, the test results will automatically be plotted and compared to the theoretical values from the relay specific time curve that was selected. Up to 8 test points may be selected. If the test Multiple is changed, the appropriate theoretical trip time will change automatically.

### VIEW TEST REPORTS

To view the test result, press the Add Results to Report and View button. The user can now enter appropriate information relative to the test in the Test Report header. See the following example report.

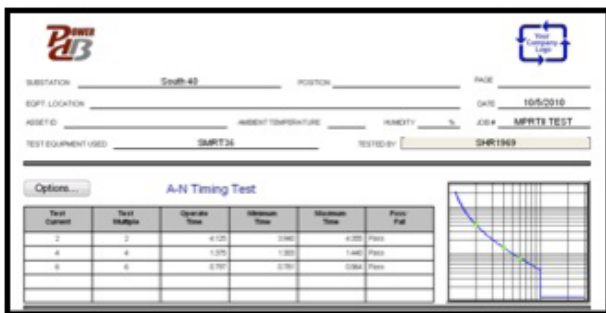

Figure 5 Test Report Alstom IEC Inverse Timing Test

Note that the software automatically compared the Operating Time to the theoretical and made a Pass/Fail determination based upon the manufacturer's time curve characteristic. If the recorded test point(s) is out of specification it appears red in color. If it is within

specification it will be green in color. This provides excellent visual As Found reporting. If the data is imported into PowerDB, reports can be generated that summarize the comments and failures of every test you perform for future NERC reporting requirements.

### STATE SEQUENCE TIMING TEST FEATURE

Pressing the State Sequence button on the test menu list takes the user to the Sequence Timing Test Screen. There are up to 15 programmable steps available in the Sequencer Test Screen.

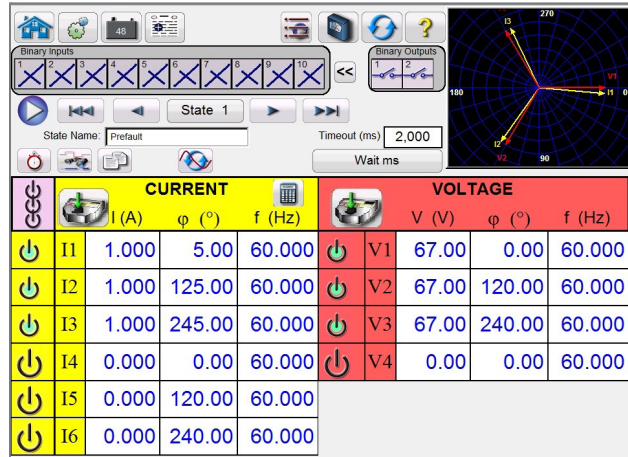

Figure 6 Sequence Test Screen

By default, 9 states are already labeled as Prefault, Trip1, Reclose 1, etc. up to Lockout in step 9. Therefore, it is initially setup for a four shot trip, reclose to lockout scenario. The user is free to change the labels, or use the default labels. With each state the user may input values of voltage, current, phase angle, frequency and set the Binary Input sensing for each state. Both single pole and three pole trip can be simulated. There are default values and binary settings for a single phase trip and reclose scenario already programmed in. The user can either use the defaults or change them to suit the application. The Total Time to Lockout is also included in the setting and indicates where the total timer starts and stops. This allows for 1, 2, 3, or 4 shots to lockout including trip and reclose times. The user can set conditional settings such as Wait IRIG time setting (for End-to-End tests), Wait milliseconds, Wait cycles, Wait any contact (OR), and Wait all contacts (AND). The user can set the Binary Outputs to simulate the 52a and/or 52b contacts.

Once all of the Binary Inputs, Outputs, Prefault, Fault and Reclose settings are completed, the user can then press the Preview button to get a visual representation of the voltage and current outputs, as well as a visual of the binary inputs and outputs for each stage of the simulation. The following figure illustrates a sample sequence.

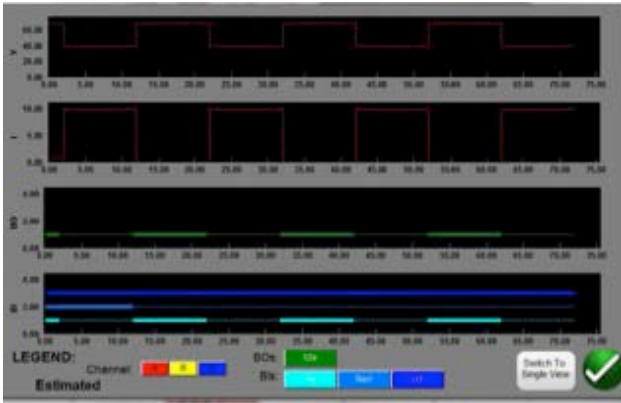

Figure 7 Sample Sequence Voltage, Current, Binary Inputs and Outputs

**IMPEDANCE RELAY CLICK-ON-FAULT**

The all new Click-On-Fault (COF) is one of the choices in the test menu list. The new COF provides automatic tests of Impedance (distance) relays. It includes Ramp, Pulse Ramp, Pulse Ramp Binary Search, and Shot test capabilities.

**SELECTION OF RELAY OPERATING CHARACTERISTICS**

Select from one the predefined generic relay characteristics of MHO, Half MHO or QUAD (Quadrilateral), or import a RIO file supplied by a number of relay manufacturers, or select from the relay specific Relay Library files. The Relay Library includes distance relays from SEL, GE, AREVA, and ABB. There are numerous other library test files which are still being tested and field evaluated. Therefore, as new relay library files become available a new version of the software will be posted to the website for free download.

**DEFINITION OF OPERATING CHARACTERISTIC AND TESTS**

There are several new innovations in the new COF that make testing distance relays easier and faster. For example, selecting the Generic MHO characteristic provides the following user input screen.

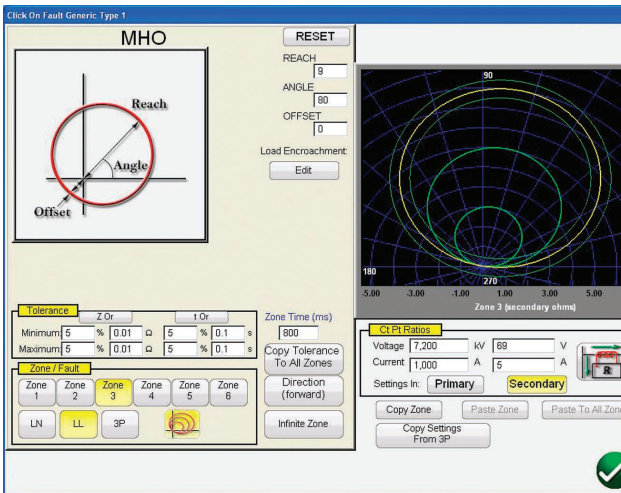

Figure 8 Generic MHO Setting Screen

Here the user selects which Zone (up to 6 zones may be defined), type of fault, direction, tolerance values, inputs the reach, max torque (line) angle; any offset, or load encroachment settings. The software draws the operating characteristic(s) of the relay defined by the user settings. The user may select to view single zone or multiple zones. Pressing the green check button takes the user to the COF test setup screen, as shown in the following figure.

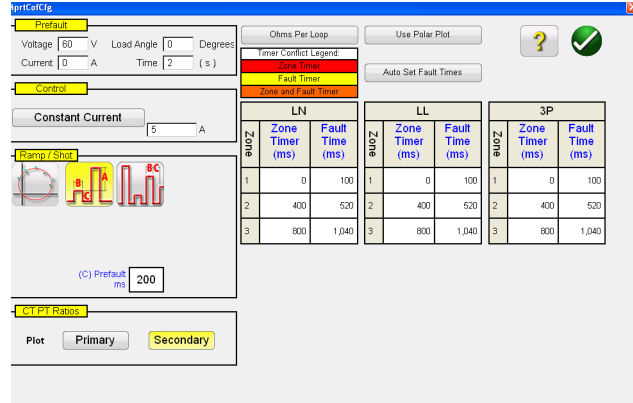

Figure 9 Generic MHO Test Setup Screen

From this screen the user can select:

**Test Method-**

- Pulse Ramp
- Pulse Ramp Binary Search
- Shot

**Timing of Fault -**

- Phase to Ground
- Phase to Phase
- Three Phase

**Test Source Models -**

- Constant Voltage
- Constant Current
- Constant Source Impedance

**Displayed Values -**

- Primary Values
- Secondary Values

**CREATING SEARCH LINES OR SHOT TEST POINTS**

The user can easily define up to 10 search lines or test points per fault type, per zone. Test options include;

The **Independence Test** option provides maximum freedom to the user to select any test line, at any angle, around the operating characteristic.

The **Origin Test** option the user clicks a point outside the operating characteristic, and the test line will be drawn to the origin or the intercept of the R and X axis.

The **Shots Test Points** option is used to create one or more test points, each to replicate a fault at a particular magnitude and angle. This type of test provides a quick GO, NO/GO test of the relay after a settings change.

The user does not even have to draw the test lines. There are two **Quick Test Options** the user may select. The first option draws three test lines for any of the selected Quick Test solutions. The second Quick Test the user may select the desired number of test points by pressing the Test Points button and select from the list. If none of the standard phase rotations meets the user's needs, they can enter the desired phase rotation in the window provided.

### IEC 60255 TEST OPTION

To comply with regulations which require testing to the IEC 60255 standard, the IEC 60255 option is also provided. All defined test lines will automatically be drawn perpendicular to the relay operating characteristic.

### DEFAULT SETTINGS

For testing relays which require a pre-fault load condition, the user can set the pre-fault load voltages and currents. This is normally used when testing accelerated tripping or dynamic over-reach characteristics.

### PERFORMING TESTS

The user then simply presses the blue Play button and the test begins. To save even more time the user can select the Play All button and the software will automatically test all defined zones and faults in sequence. Based upon the user input the software will calculate all of the fault values and angles for each defined test point, and then make PASS/FAIL determination of the test results.

A real-time test screen will display the relay operating characteristic with the defined test lines in the right half of the screen with the test vector moving in the impedance plane, and in the left half it will display either the test vectors of voltage and currents being applied in real-time, or it will display the Positive, Negative and Zero Sequence vectors being applied, see the following example.

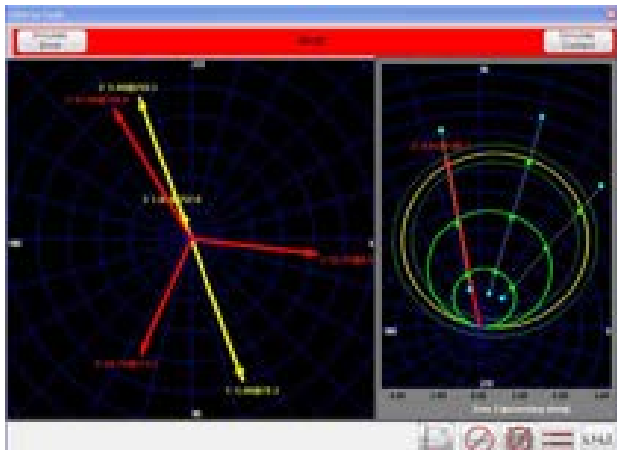
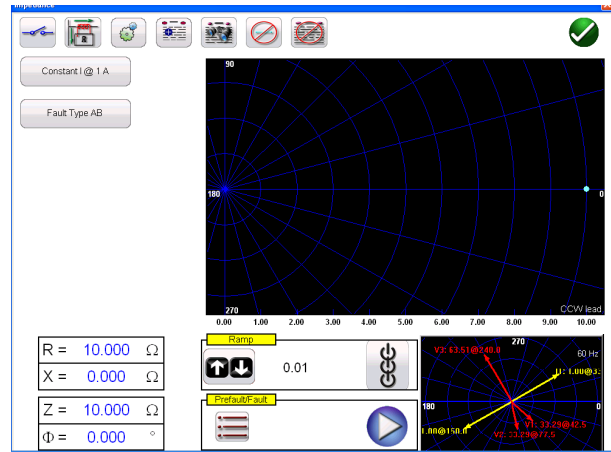

Figure 10 Generic MHO Real-Time Test Screen

In the above figure a Zone 3, Pulse Ramp, Phase A-B fault is being performed. Note the real-time test amplitudes and angles are displayed in the left half, with the test results displayed in the right half.

### Easy Z Impedance Relay Test

The STVI-software Easy Z provides a quick approach to testing an impedance relay. The following is the test screen for the Easy Z Impedance Test Screen. All tests are performed from this one screen.



Easy Z Test Screen

CT Polarity Directional button sets the phase angle of the output currents either into or out of the zone.

Constant Source button  provides the user with a selection of different methods to perform the tests. Some manufacturers require Constant Voltage and ramp current, some require Constant Current and ramp voltage.

Fault Type  selection button provide the user with the Fault Type selection window. The user can select Three Phase Fault, Phase to Phase fault, or Phase to Ground fault. Note there is no ground compensation in the Easy Z test screen. For tests using ground compensation calculations see the Click On Fault test.

In the Ramp selection window the user can ramp outputs in terms of Z, R, X or the angle Phi. The increment of the ramp is also selected in this window. For example, the user desires to ramp impedance Z in 0.01 Ohms as shown above.

### TRANSFORMER DIFFERENTIAL TEST FEATURE

The Transformer Differential Test feature provides automatic tests of three phase Transformer Current Differential relays. It includes Stability, Pickup, Timing, Slope, Harmonic Block and Harmonic Shot tests.

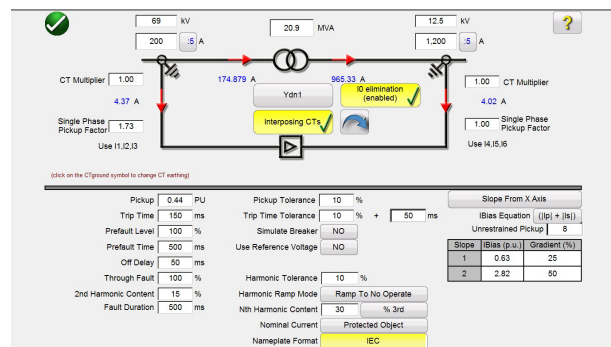

Figure 11 ANSI Transformer Differential Model

### TRANSFORMER MODEL AND NAMEPLATE SETTINGS

There are two transformer differential models to choose from, ANSI and IEC. Each model will present a transformer graphic commonly used either for North American or European style transformer protection. The values entered in the Transformer Nameplate section will determine what values of current and phase angle relationships get applied to the relay in the tests.

### DEFINITION OF SLOPE CHARACTERISTIC AND TESTS

There are several new innovations in the Transformer Differential Test feature that make testing three phase transformer differential relays easy and fast. For example, the slope characteristics vary by manufacturer design. Four options are provided, which cover the various designs; Line Segments, Slope Through X Axis, Slope Through Origin and Slope From Base Point. In addition, different relay manufacturers use different IBias equation methods for restraining the operation of the differential elements. The Transformer Differential Slope test provides seven different biasing (restraint) equations to choose from. Touch the STVI screen to create test lines associated with the slope characteristic. The following is an example test being performed with four test lines.

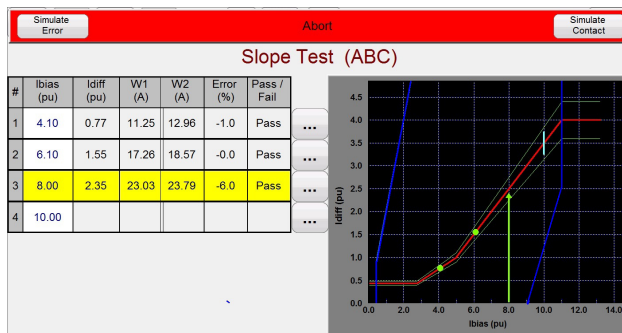

Figure 12 Transformer Differential Slope Test

### FEATURES AND BENEFITS

**Large Color TFT LCD touch-screen display** - Easy to use and read (even in direct sunlight) display provides manual control of the test set. Color contrasts accentuate vital information. This reduces human error and time in testing relays.

**Constant Power Output** –The current amplifier delivers maximum compliance voltage to the load constantly during the test, and range changing is done automatically under load. This insures better test results, and saves time by not having to turn the outputs off to change ranges. Constant power output in many cases eliminates the need to parallel and/or series current channels together to test high burden relays, which also saves time.

**High Output Current** – The SMRT410D provides up to 30 Amps at 200 VA per phase continuous, or up to 60 Amperes at 300 VA with a 1.5 second duty cycle. With only three current amplifiers in parallel it can provide a 180 Amperes at 900 VA for testing all instantaneous overcurrent relays.

#### New PowerV™ Voltage Amplifier High Power Output-

The SMRT410D provides a new higher VA output on the voltage channel at the lower critical test voltages (from 30 to 150 Volts). Users, who want to test a panel of relays at one time, or certain older electromechanical impedance relays, find it impossible using lower VA rated voltage.

**STVI Displays high resolution and accuracy** – Metered outputs and timer provides extremely high accuracy. With metered outputs, what you see is what you get.

**Steady-State and Dynamic test capability** –The SMRT410D provides, either through manual control or computer control, both steady-state and dynamic testing of protective relays. This includes programmable waveforms with dc offset and harmonics.

**STVI graphics and intuitive navigation** – New test graphics and easier screen navigation saves test time and reduces human error.

**Internal memory** – Provides storage of test set-up screens and test reports, which reduces testing time and paper work.

**Display screen provides four different languages** - The display screen prompts the user in English, Spanish, French, or German.

**Digital inputs and outputs** - 10 programmable inputs, and 6 programmable outputs provide timing and logic operations in real-time with the output voltage and currents. Binary Inputs can be programmed, using Boolean logic, for more complex power system simulations. This provides a low cost, closed loop, power system simulator.

**Circuit breaker simulator** – Binary outputs provide programmable normally closed and normally open contacts to simulate circuit breaker operation for testing reclosing relays. Sequence of operation, timing, and lockout are easily tested.

**Performs transient tests** – The SMRT410D can perform acceptance or troubleshooting tests by replaying digitally recorded faults, or EMTP/ATP simulations, in the IEEE- C37.111, COMTRADE Standard format.

**Perform End-to-End tests** – Using AVTS™ software Dynamic Control, or the STVI Sequencer Test; with a portable GPS satellite receiver (or suitable IRIG-B time code source input into Binary Input #1), the SMRT410D performs satellite-synchronized end-to-end dynamic or transient tests. This provides precisely synchronized testing of remotely located complex protection schemes.

**Perform Multi-Phase Tests** - The SMRT410D can be interconnected with a SMRT36, or SMRT410, or a SMRT1 single phase unit to increase the total number of test currents for testing multi-phase bus differential protection schemes. For example, a 5 channel SMRT410D, interconnected with a 3 channel SMRT36 unit provides a maximum of 16 current channels. The STVI software supports up to 24 currents for testing bus differential protection schemes.

**Three Ethernet Ports** - The Ethernet port provides a high-speed computer interface, IEC-61850 test capability, and an interface for interconnecting other SMRT units for multi-phase test applications. There is one dedicated isolated Ethernet port which provides secure isolation when testing IEC 61850 devices (for customers who require secure isolation from their IEC 61850 substation bus).

**USB 2.0 interface port** – The USB port provides a PC interface for automated control of the SMRT410D unit. Also provides secure isolation when testing IEC 61850 devices (for customers who require secure isolation from their IEC 61850 substation bus).

**Immediate error indication** – Audible and visual alarms indicate when amplitude or waveforms of the outputs are in error due to short circuit, open circuit, or thermal overload.

**Open communication architecture** – Use with third party software for more flexible automated control.

## SPECIFICATIONS

### Input

100 to 240 Volts AC, 1Ø, 50/60 Hz, 1800 VA.

### Outputs

All outputs are independent from sudden changes in line voltage and frequency. All outputs are regulated so changes in load impedance do not affect the output. Each output (VIGEN) module consists of one voltage amplifier, and a current amplifier. The voltage amplifier may be converted to a current source. Therefore, one amplifier module may be used to test single phase current differential relays, including harmonic restraint.

### Output current sources

Output Current Sources

The SMRT410D with four VIGEN and one DIGEN (Double Current) modules can provide up to ten current sources; six high current/high power, four convertible voltage channels providing lower current/high power. The per channel output current and power ratings are specified in AC rms values and peak power ratings.

### Per channel output

Output Current	Power	Max V
1 Ampere	15 VA	15.0 Vrms
4 Amperes	200 VA (282 peak)	50.0 Vrms
15 Amperes	200 VA (282 peak)	13.4 Vrms
30 Amperes	200 VA (282 peak)	6.67 Vrms
60 Amperes	300 VA (424 peak)	5.00 Vrms

DC 200 Watts

**Duty Cycle:** 30 Amps Continuous, 60 Amps 1.5 seconds

### Three currents in parallel

Output Current	Power	Max V
12 Amperes	600 VA (848 peak)	50.0 Vrms
50 Amperes	600 VA (848 peak)	13.4 Vrms
90 Amperes	600 VA (848 peak)	6.67 Vrms
180 Amperes	900 VA (1272 peak)	5.00 Vrms

### Four currents in parallel

Output Current	Power	Max V
16 Amperes	800 VA (1132 peak)	50.0 Vrms
60 Amperes	800 VA (1132 peak)	13.4 Vrms
120 Amperes	800 VA (1132 peak)	6.67 Vrms
240 Amperes	1200 VA (1697 peak)	5.00 Vrms

### Two currents in series

With two currents in series, the compliance voltage doubles to provide 4.0 Amperes at 100 Volts.

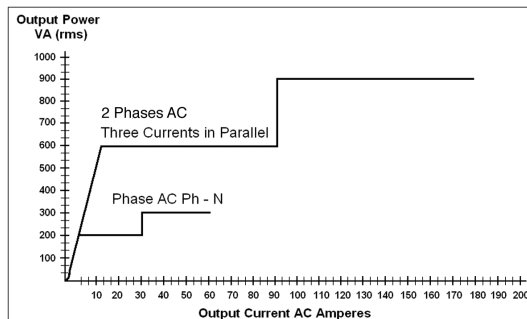

Figure 13 Current Output Power Curve

### Current Amplifier-Extended Power Range

The SMRT410D current amplifier provides a unique flat power curve from 4 to 30 Amperes per phase to permit testing of electromechanical high impedance relays, and other high burden applications, with an extended operating range up to 60 Amperes at 300 VA rms for short durations.

### AC voltage output

Outputs are rated with the following Ranges:

Output Volts	Power	Max I
30 Volts	150 VA	5 Amps
150 Volts	150 VA	Variable
300 Volts	150 VA	0.5 Amps

DC 150 Watts

Duty Cycle: Continuous

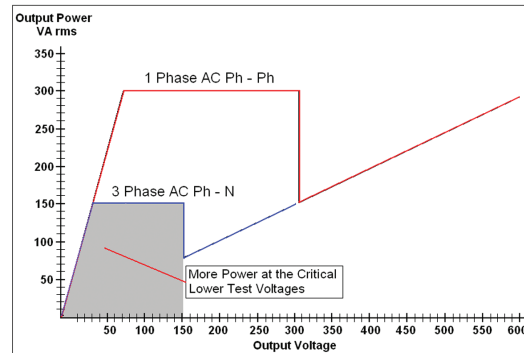

Figure 14 Voltage Output Power Curve

### "PowerV<sup>®</sup>" Voltage Amplifier-Extended Power Range

The SMRT410D voltage amplifier provides a flat power curve from 30 to 150 Volts in the 150V range to permit testing of high current applications such as panel testing, and older electromechanical distance relays which demand a higher power voltage source to properly test.

### Voltage amplifier in current mode

The voltage amplifier is convertible to a current source with the following output capability. Output power ratings are specified in AC rms values and peak power ratings.

Output Current	Power	Max V
5 Amperes	150 VA (212 peak)	30.0 Vrms
15 Amperes	120 VA	8.0 Vrms

Duty Cycle: 5 Amps Continuous, 15 Amps 1.5 seconds

### Battery simulator

The battery simulator provides a continuously variable DC output voltage ranging from 5 to 250 Volts at 100 Watts, 4 Amps max, providing capability to power up relays with redundant power supplies. Voltage output is controlled via the front panel control knob, or through AVTS software.

### Metering

Measured output quantities such as AC Amperes, AC Volts, DC Volts or DC Amperes, and Time may be simultaneously displayed on the touch screen. Other values that may be displayed, depending on which test screen is in view, are phase angle, frequency, Ohms, Watts, VA, and Power Factor. All Accuracies stated are from 10 to 100% of the range at 50/60 Hz.

### AC voltage amplitude

**Accuracy:**  $\pm 0.05\%$  reading +  $0.02\%$  range typical,  $\pm 0.15\%$  reading +  $0.05\%$  range maximum

**Resolution:** .01

**Measurements:** AC RMS

**Ranges:** 30, 150, 300V

### AC current amplitude

**Accuracy:**  $\pm 0.05\%$  reading +  $0.02\%$  range typical,  $\pm 0.15\%$  reading +  $0.05\%$  range maximum

**Resolution:** .001/.01

**Measurements:** AC RMS

**Ranges:** 30, 50A

## DC Voltage Amplitude

**Accuracy:** 0.1% range typical,  
0.25% range maximum

**Resolution:** .01

**Measurements:** RMS  
**Ranges:** 30, 150, 300V

## DC Current Amplitude

**Accuracy:**  $\pm 0.05$  % reading + 0.02 % range typical,  
 $\pm 0.15$  % reading + 0.05 % range maximum

**Resolution:** .001/.01

**Measurements:** RMS  
**Ranges:** 30A

## Convertible Source in AC Current Mode

**Accuracy:**  $\pm 0.05$  % reading + 0.02 % range typical,  
 $\pm 0.15$  % reading + 0.05 % range or  $\pm 12.5$  mA whichever is greater

**Resolution:** .001

**Measurements:** AC RMS  
**Ranges:** 5, 15A

## DC IN Inputs (Optional Transducer Feature)

### DC IN Volts

**Range:** 0 to  $\pm 10$  V DC

**Accuracy:**  $\pm 0.001$  % reading + 0.005 % range Typical  
 $\pm 0.003$  % reading + 0.02 % range Max

**Resolution:** .001

**Measurements:** Average

### DC IN Amperes

**Range:** 0 to  $\pm 1$  mA DC

4 to  $\pm 20$  mA DC

**Accuracy:**  $\pm 0.001$  % reading + 0.005 % range Typical  
 $\pm 0.003$  % reading + 0.02 % range Max

**Resolution:** .001

**Measurements:** Average

## Total Harmonic Distortion

Less than 0.1% typical, 2% maximum at 50/60 Hz

## Timer

The Timer-Monitor Input is designed to monitor and time-tag inputs, like a sequence of events recorder. In addition, the binary input controls enable the user to perform logic AND/OR functions, and conditionally control the binary output relay to simulate circuit breaker, trip, reclose and carrier control operation in real-time. The Timer function displays in Seconds or Cycles, with the following range and resolution:

**Seconds:** 0.0001 to 99999.9 (Auto Ranging)

**Cycles:** 0.01 to 99999.9 (Auto Ranging)

**Accuracy:**  $\pm 0.001$  % of reading, typical.  $\pm 2$  least significant digit,  
 $\pm 0.005$  % of reading from 0 to 50° C maximum

## Binary Input – Start/Stop/Monitor Gate

10 inputs monitor operation of relay contacts or trip SCR, continuity light is provided for the input gate. Upon sensing continuity the lamp will glow. In addition to serving as wet/dry contacts the Binary Inputs may be programmed to trigger binary output sequence(s).  
Input Rating: up to 300 V AC/DC

## Binary Output Relays

SMRT410D has 6 independent, galvanically isolated, output relay contacts to accurately simulate relay or power system inputs to completely test relays removed from the power system. The binary output simulates normally open, or normally closed, contacts for testing breaker failure schemes. The binary output can be configured to change state based on binary input logic.

## High Current Output Relays 1 to 4:

**AC Rating:** 400 V max., I<sub>max</sub>: 8 amps, 2000 VA max.

**DC Rating:** 300 V max., I<sub>max</sub>: 8 amps, 80 W

**Response Time:** <10ms

## High Speed Output Relays 5 and 6:

**AC/DC Rating:** 400 V peak, I<sub>max</sub>: 1 amp

**Response Time:** <1ms typical

## Waveform Storage

Each output channel can store waveforms for playback on command. End-to-end playback of stored waveforms is possible, when triggered externally by a GPS receiver. Each channel can store up to 256,000 samples.

## Protection

Voltage outputs are protected from short circuits and prolonged overloads. Current outputs are protected against open circuits and overloads.

## Conformance Standards

**Safety:** EN 61010-1

**Shock:** EN/IEC 60068-2-27

**Vibration:** EN/IEC 68-2-6

**Transit Drop:** ISTA 1A

**Free Fall:** EN/IEC 60068-2-32

**Drop / Topple:** EN/IEC 60068-2-31

## Electromagnetic Compatibility

**Emissions:** EN 61326-2-1, EN 61000-3-2/3, FCC Subpart B of Part 15 Class A

**Immunity:** EN 61000-4-2/3/4/5/6/8/11

## Environmental

**Operating Temperature:** 32 to 122° F (0 to 50° C)

**Storage Temperature:** -13 to 158° F (-25 to 70° C)

**Relative Humidity:** 5 - 90% RH, Non-condensing

## Dimensions

13.25 W x 6.75 H x 15 D in.

337 W x 172 H x 381 D mm

## Weight

Weight varies depending on the number of output modules in the system. The weight below is for a complete full multi-phase test system.

42.65 lb. (19.2 kg)

## Enclosure and Transit Cases

The unit comes mounted in a rugged enclosure for field portability. An optional hard-sided transit case is available. The robust design of the optional hard-sided transit case provides protection when transporting the unit over rugged terrain and long distances. An optional soft-sided carry case protects the unit from light rain and dust. The padded sides provide moderate protection while in transit.



## Model SMRT410 Ordering Information

## Style Number Identification

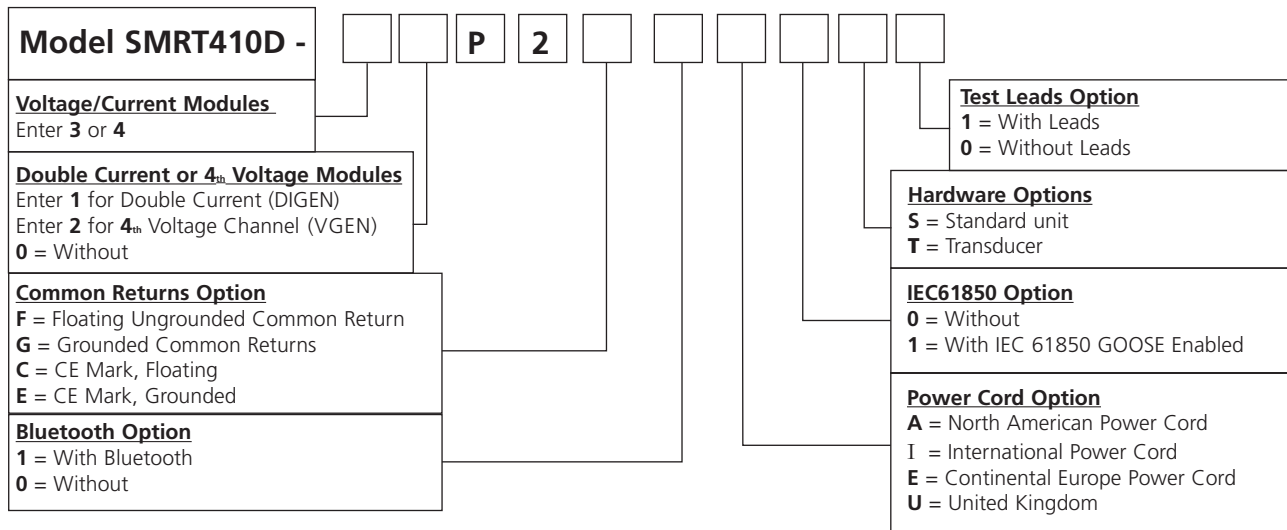

### Descriptions of Hardware Options

This modular system lets you select the testing capabilities you need now and expand as testing requirements change. Customize the system by adding the number of Voltage-Current amplifier (VIGEN) modules (3 or 4), with optional Double-Current (DIGEN), or Voltage-Only (VGEN) modules. For 4 Voltages and 3 currents order the unit with 3 VIGENS and 1 VGEN. For more demanding tests; order with 4 VIGENS, and a DIGEN, to provide 4 Voltages, 6 Currents simultaneously, and with convertible voltage channels it will provide up to 10 Currents.

**Voltage/Current Modules:** The SMRT410D unit can have 3 or 4 voltage/current modules. Enter the number of desired modules 3 or 4.

**Double Current, or 4th Voltage Module:** The SMRT410D 5th slot can be a Double Current (DIGEN) Module. Enter the number 1 for the unit to come with the DIGEN. The 4th slot can host a single Voltage Channel (VGEN) for those who want a 4th voltage channel in addition to 3 Voltage/Current modules. Enter the number 2 for this option. Enter 0 for neither optional module.

**Common Returns Option:** The floating returns option provides independent isolated return terminals for each output channel. The grounded common returns option, the return terminals are interconnected internally and connected to chassis ground. The CE Mark, C and E units have been certified to the IEC standards for EMC for both the grounded and floating options. The F and G units are designed to operate in countries which do not require the CE mark.

**Bluetooth Option:** For customers, who wish to have a wireless control of the SMRT unit enter the number 1 for the unit to come with the Bluetooth option, or enter 0 for without Bluetooth option.

**Power Cord Option** Customers can choose which type of power cord they want the unit to come with.

- **A** option – NEMA 5-15 to IEC60320 C13 connectors, UL & CSA approved for countries with NEMA outlets.
- **I** option - International color coded wires (light blue, brown and green with yellow stripe) insulation jacket stripped ready for male connector with IEC 60320 C13 connector. CE marked.
- **E** option - CEE 7/7 "Schuko" plug to IEC 60320 C13 connector is CE marked.
- **U** option – United Kingdom power cord with IEC 60320 C13 connector, and 13 Amp fuse. BS 1363 / CE Marked.

**IEC 61850 Option:** The SMRT410D in conjunction with the Megger GOOSE Configurator (MGC) software can be used in the testing or commissioning of IEC 61850 compliant devices. In order for the SMRT410D to be able to subscribe as well as publish GOOSE messages, the IEC 61850 feature needs to be enabled. Enter the number 1 for the unit to come with the IEC 61850 option enabled. Enter 0 for the unit without IEC 61850 enabled.

**Options:** S= Standard unit. T= With Transducer test capability enabled.

**Test Leads Option:** Enter the number 1 for the unit to come with Test Leads. Enter 0 for the unit without Test Leads.

### Descriptions of Software Options

#	Included Software	Part Number
1	AVTS Basic with STVI Application CD	<b>81302</b>
5	<b>Optional Software</b>	
1	AVTS Basic with IEC 61850 Megger GOOSE Configurator & STVI Application CD	<b>1002-103</b>
2	AVTS Advanced with STVI Application CD	<b>81570</b>
3	AVTS Advanced Test with IEC 61850 Megger GOOSE Configurator & STVI Application CD	<b>1001-106</b>
4	AVTS Professional with STVI Application CD	<b>81571</b>
5	AVTS Professional Test with IEC 61850 Megger GOOSE Configurator & STVI Application CD	<b>1002-102</b>

### Descriptions of Software

**Included Software** – Every unit comes with **AVTS Basic**, and the PC version of the **STVI Application** software

AVTS Basic with STVI Application Software (PC Version)

Part Number: 81302

AVTS Basic includes Online Vector, Online Ramp and Online Click-On-Fault controls, with the ability to import, execute and save relay specific test modules. The easy to use online tools of Vector and Ramp provide automatic pickup, or dropout tests as well as timing and multi-state dynamic tests. The Online Click-On-Fault tool is used to automatically determine the reach characteristics of single or multi-zone Distance relays using shot for single point tests, or Ramp, Pulse Ramp, or Binary Search tools along user defined search lines. Basic also includes enhanced Relay Test Wizards for; Overcurrent, Differential, Voltage, Frequency and Distance relays. AVTS Basic does not require a software license key to run.

The powerful STVI Application software can be run directly from a PC providing both manual and automatic test capabilities. Intuitive easy to use menus and function buttons are provided to quickly and easily select the desired test function. The Manual Test Screen power-up preset default values of voltage, current, phase angles and frequency maybe automatically set from the user defined configuration screen. The user can select from a variety of test options including manual control using the cursor up down arrows or use the mouse control wheel to vary outputs. In addition a dynamic sequence test screen includes trip and reclose up to 15 stages. An automatic ramp, pulse ramp, or pulse ramp binary search is built in to determine pickup or drop out of relay contacts. Perform relay specific timing tests using the Timing Test Screen, which includes hundreds of time curve characteristics from 20 different relay manufacturers, as well as standard time curve algorithms from ANSI, IEC, and IEEE. A vector graph indicates the relative phase angles of all of the outputs, or the user can select to view the outputs in terms of positive, negative, and zero sequence vectors. The user may select to have all output amplitudes metered to provide real time verification of all of the selected outputs, or have setting values displayed. The new Click-On-Fault provides automatic tests of Impedance relays. It includes Ramp, Pulse Ramp, Pulse Ramp Binary Search, and Shot test capabilities. The Click-On-Fault also includes a Relay Library with ready-to-use test modules for many of the most popular distance relays, and it includes the ability to import RIO files from different relay manufacturers. The all new Transformer Differential Test feature provides automatic tests of three phase Transformer Current Differential relays. It includes Stability, Pickup, Timing, Slope, Harmonic Block and Harmonic Shot tests. The PC version of the STVI software includes the ability to bring all STVI test data (from the test set) into file folders for retrieval and review whenever needed. The PC version of the STVI software comes with a USB software license key to run on any PC.

### Additional Optional Software

**AVTS Advanced with STVI Application**

Part Number: 81570

AVTS Advanced includes all of the features of AVTS Basic in addition to the powerful Test Editor and test editor tools, which includes the Dynamic Control (with dynamic end-to-end test capability, and Recorder features) for developing sequential tests for virtually any function or measuring element within digital relays. In addition, it also includes Modbus communications for automatic download of settings, SS1 File Converter for ASPEN® and CAPE® dynamic test files, End-to-End DFR Playback test capability and basic programming Tools for creating and editing test modules. Software comes with a USB software license key to run on any PC. Test files created in Advanced Test can be used with any PC running AVTS Basic without a software license key.

**AVTS Professional with STVI Application**

**Part Number: 81571**

Professional Test includes all of the features of AVTS Advanced Test version plus the following additional specialized test tools. The DFR Waveform Viewer and Playback tools are used for viewing and analyzing IEEE C37.111 COMTRADE Standard files from digital fault recorders and microprocessor based relays. The DFR Waveform Viewer includes tools to recreate the analog and digital channels for playback into protective relays for troubleshooting or evaluation. It includes the capability to extend the pre-fault data as well as start the timer associated with the event to time relay operation. These playback test files can also be used in end-to-end tests to recreate the transient event and evaluate the protection scheme. Test files created in Professional can be used with Advanced Test and Basic. Also included is the One-Touch Test Editor Control Tool for fully automatic testing of microprocessor based relays using VB script files to automatically download relay settings, and automatically test all the measuring elements within the relay based upon those settings. The Waveform Digitizer feature is also included in the Professional Test version of AVTS. It provides tools to create digital time curves for virtually any electromechanical relay time curve (that do not fit a time curve algorithm). It can even be used for digitizing scanned waveforms from a light-beam chart recorder. Software comes with a USB software license key to run on any PC. Test files created in Professional Test can be used with any PC running AVTS Basic without a software license key.

**IEC 61850 Megger GOOSE Configurator Software**

**(See Table for Part Numbers)**

The Megger GOOSE Configurator (MGC) provides easy to use tools for testing relays and substations using the IEC 61850 protocol. It is an optional software tool available with Basic, Advanced or Professional versions of AVTS Software; see Descriptions of Software Options above. The Configurator provides relay test engineers and technicians the capability to import parameters from configuration files in the Substation Configuration Language (SCL) format, and/or capture GOOSE messages directly from the substation bus. All imported SCL GOOSE messages will be unconfirmed messages. Only captured messages are confirmed messages due to the Capture feature of the MGC. Use the MGC Merge feature to compare imported SCL and captured GOOSE messages to verify all GOOSE messages needed to perform tests. Use them to configure the SMRT to subscribe to preselected GOOSE messages by assigning the data attributes to the appropriate binary inputs of the SMRT. Use the configurator to assign the appropriate binary outputs of the SMRT to publish GOOSE messages simulating circuit breaker status. After the appropriate assignments of binary inputs and outputs have been made, the test file can be saved for reuse. This provides both manual and automatic testing of the relay using either the STVI or AVTS software. Use standard test modules in AVTS to perform automatic tests. Use the Dynamic Control in AVTS Advanced or Professional to perform high speed trip and reclose tests, or use to perform interoperability high-speed shared I/O tests between multiple IED's. The MGC provides mappings of Boolean and Bit Strings and/or simulation of STRuct, Integer/Unsigned, Float and UTC datasets.

**Test Leads and Accessories**







All units come with a power cord, an Ethernet communication cable, and instruction manual. All other accessories varies depending on the number of amplifier modules selected, see Table of Accessories.

**Included Standard Accessories**

<b>Description</b>	<b>Part Number</b>
Power Cord - Depending on the style number, the unit will come with one of the following,	
Line cord, North American.....	90015-267
Line cord, Continental Europe with CEE 7/7 Schuko Plug.....	90015-268
Line cord, International color coded wire.....	90015-269
Line cord, United Kingdom .....	90015-270
Ethernet cable for interconnection to PC, 210cm (7 ft.) long (Qty. 1 ea.) .....	90003-684
Instruction manual (digital copy) .....	81757

**Table of Accessories**

Accessories are supplied with the selection of the Test Leads Option. With the Test Leads Option the number and type of leads varies depending on the number of channels ordered. Test Leads and Accessories can be ordered individually, see part numbers below.

	<b>Descriptions of Optional Test Leads and Accessories</b>	<b>Test Leads Option</b>	<b>Three (3) Voltage Current Modules</b>	<b>Four (4) Voltage Current Modules</b>	<b>With DIGEN Module</b>	<b>With VGEN and/or Transducer Option</b>
	<b>Accessory Carry Case:</b> Use to carry power cord, Ethernet cable, Optional STVI and test leads.	Qty. 1 ea. Part No. <b>2003-725</b>				
	<b>Sleeved Pair of Test Leads:</b> Sleeved Test Leads, one red, one black, 200 cm (78.7") long, 600 V, 32 Amperes CAT II		Qty. 2 pr. Part No. <b>2001-394</b>	Qty. 4 pr. Part No. <b>2001-394</b>	Qty. 2 pr. Part No. <b>2001-394</b>	Qty. 4 pr. Part No. <b>2001-394</b>
	<b>Cable / Spade Lug Adapter (Small):</b> Small lug fit most new relay small terminal blocks. Lug adapter, <b>red</b> , 4.1 mm, rated up to 1000 V/ 20 Amps CAT II  Lug adapter, <b>black</b> , 4.1 mm, rated up to 1000 V/ 20 Amps CAT II		Qty. 14 ea. Part No. <b>684004</b>  Qty. 14 ea. Part No. <b>684005</b>	Qty. 18 ea. Part No. <b>684004</b>  Qty. 18 ea. Part No. <b>684005</b>	Qty. 2 ea. Part No. <b>684004</b>  Qty. 2 ea. Part No. <b>684005</b>	Qty. 1 ea. Part No. <b>684004</b>  Qty. 1 ea. Part No. <b>684005</b>
	<b>Jumper Lead:</b> Jumper lead, black, 12.5 cm (5") long, use with voltage / current outputs, 600 V, 32 Amps CAT II		Qty. 4 ea. Part No. <b>2001-573</b>	Qty. 6 ea. Part No. <b>2001-573</b>		
	<b>Sleeved Combination Voltage Test Leads:</b> Three common leads connect to the test set, which are interconnected to one black common to connect to the relay. Sleeved, three red and black, 200 cm (78.7") long, 600 V, 32 Amperes CAT II		Qty. 1 ea. Part No. <b>2001-395</b>	Qty. 1 ea. Part No. <b>2001-395</b>		
	<b>Sleeved Combination Current Test Leads:</b> Three pairs of leads connect to the test set, and to the relay under test. Sleeved, three red and black, 200 cm (78.7") long, 600 V, 32 Amperes CAT II		Qty. 1 ea. Part No. <b>2001-396</b>	Qty. 1 ea. Part No. <b>2001-396</b>		

## Additional Optional Accessories (Not Included in the SMRT Optional Test Lead Accessories) -

Additional Optional Test Leads and Accessories can be ordered individually, see description and part numbers below.

The following accessories and part numbers are in quantities of 1 each. Order the appropriate number required.

<b>Description</b>	<b>Part Number</b>
--------------------	--------------------

**Individual (Non-Sleeved) Test Leads:** Excellent for widely separated individual terminal test connections.



- |  |               |
|--|---------------|
| Test Lead, red, use with voltage/current output, or binary I/O,<br>200 cm long (78.7") 600 V/ 32 Amps CAT II.....    | <b>620143</b> |
| Test Lead, black, use with voltage/current output , or binary I/O,<br>200 cm long (78.7") 600 V/ 32 Amps CAT II..... | <b>620144</b> |

**Extra-Long Individual (Non-Sleeved) Test Leads:** Excellent for widely separated individual terminal test connections.



- |   |                 |
|---|-----------------|
| Test Lead, red, use with voltage/current output,<br>or binary I/O, 360 cm long (144") 600 V/ 32 Amps CAT II.....    | <b>2003-173</b> |
| Test Lead, black, use with voltage/current output ,<br>or binary I/O, 360 cm long (144") 600 V/ 32 Amps CAT II..... | <b>2003-174</b> |

**Jumper Lead:** Used to common returns together externally when paralleling current channels (not required when using the sleeved combination current leads **2001-396**).



- |   |                 |
|---|-----------------|
| Jumper lead, black, 12.5 cm (5") long, use with voltage / current outputs,<br>600 V, 32 Amps CAT II ..... | <b>2001-573</b> |
|---|-----------------|

**Flexible Test Lead Adapter:** Use with rail-mounted terminals or screw clamp connections where spade lugs and crocodile/alligator clips cannot be used.



- |   |                  |
|---|------------------|
| Flexible test lead adapter, black, 1.8 mm male pin, use with test leads up to<br>1000 V/ 32 Amps CAT III..... | <b>90001-845</b> |
|---|------------------|

**Flexible Test Lead Adapter with Retractable Insulated Sleeve:** Use for connection to old style non-safety sockets with retractable protective sleeve on one end.



- |   |                  |
|---|------------------|
| Retractable Sleeve Test Lead, red, 50 cm (20") long, use with test leads<br>up to 600 V, 32 Amperes CAT II.....   | <b>90001-843</b> |
| Retractable Sleeve Test Lead, black, 50 cm (20") long, use with test leads<br>up to 600 V, 32 Amperes CAT II..... | <b>90001-844</b> |

**Cable / Spade Lug Adapter (Large):** Large spade lug fits older relay terminal blocks, STATES® Company FTP10 or FTP14 Test paddles, ABB or General Electric test plugs with screw down terminals.



- |   |               |
|---|---------------|
| Lug adapter, red, 6.2 mm, use with test leads up to 1000 V/ 20 Amps CAT II.....   | <b>684002</b> |
| Lug adapter, black, 6.2 mm, use with test leads up to 1000 V/ 20 Amps CAT II..... | <b>684003</b> |

**Alligator/Crocodile Clip:** Excellent for test connections to terminal screws and pins where spade lugs cannot be used.



Alligator clip, red, use with test leads up to 1000 V/ 32 Amps CAT III ..... **684006**  
 Alligator clip, black, use with test leads up to 1000 V/ 32 Amps CAT III ..... **684007**

**In-Line Fused Test Lead:** Use with high speed binary outputs 5 or 6 to protect for accidental switching of currents higher than 1 Amp.



Test lead, blue, in-line 500 mA fuse protection, 200 cm long (78.7") ..... **568026**

**In-Line Fused Test Lead:** Use with Battery Simulator output to protect for accidental connection to substation battery.



Test lead, black, in-line 3.15 A fuse protection, 200 cm long (78.7") ..... **568025**

**In-Line Resistor Test Lead:** Use with old solid state relays with "leaky" SCR trip gates



Test lead, red, in-line 100 k Ohm resistor, use with test leads up to 1000 V/ 32 Amps CAT III ..... **500395**

**Parallel Test Lead Adapter:** Used when paralleling up to three current test leads together to a common test point Usually used when connecting to a test paddle (like the pictured States Company test paddle).



Parallel Test Lead, black, 12.5 cm (5") long, used to parallel current outputs, 600 V, 32 Amps CAT I ..... **1002-286**

**STATES® Company 10 Pole Test Paddle:** Use with STATES® FMS 10 Pole Test Switch or ABB FT-1 10 pole Test Switch



Test paddle features knobs which also serve as insulated Ø 4 mm rigid socket accepting spring loaded Ø 4 mm plugs with rigged insulating sleeve, or retractable sleeve. Use with test leads up to 600 V, 32 Amperes CAT II ..... **V1TP10**

**STATES® Company 10 Pole Test Paddle Attachment:** Use with STATES Company V1TP10 Test Paddle



Test paddle features knobs which also serve as insulated Ø 4 mm rigid socket accepting spring loaded Ø 4 mm plugs with rigged insulating sleeve, or retractable sleeve. Use with test leads up to 600 V, 32 Amperes CAT II ..... **V1TP10**

## GPS unit with accessories



- GPS unit with all-weather antenna, power supply, and 15 meter cable..... **MGTR-II-50**
- GPS unit with all-weather antenna, power supply, and 30 meter cable..... **MGTR-II-100**

**Soft-Sided Carry Case:** The soft-sided carry case protects the unit from light rain and dust. The padded sides provide moderate protection while in transit.



- Soft-sided carry case (1ea)..... **2007-218**

**Hard-Sided Transit Case:** Includes custom designed foam inserts for the SMRT410D unit, and accessories. Transit case includes retractable handle, built-in wheels, twist and lock-down latches, spring loaded fold-down handles, with O-ring seal.



- Rugged, hard-sided transit case (1ea).....**1007-363**

**UK**  
 Archcliffe Road Dover  
 CT17 9EN England  
 T +44 (0) 1304 502101  
 F +44 (0) 1304 207342  
 UKsales@megger.com

**UNITED STATES**  
 4271 Bronze Way  
 Dallas TX 75237-1019 USA  
 T 800 723 2861 (USA only)  
 T +1 214 333 3201  
 F +1 214 331 7399  
 USsales@megger.com

**OTHER TECHNICAL SALES OFFICES**  
 Valley Forge USA, College Station USA,  
 Sydney AUSTRALIA, Täby SWEDEN,  
 Ontario CANADA, Trappes FRANCE,  
 Oberursel GERMANY, Aargau SWITZERLAND,  
 Kingdom of BAHRAIN, Mumbai INDIA,  
 Johannesburg SOUTH AFRICA, Chonburi THAILAND

**CERTIFICATION ISO**  
 Registered to ISO 9001:2000 Cert. no. Q 09290  
 Registered to ISO 14001-1996 Cert. no. EMS 61597  
**SMRT410D\_DS\_EN\_V01**  
**www.megger.com**  
 Megger is a registered trademark