

Device handbook

SINEAX AM2000

Operating Instructions SINEAX AM2000
173 849 04/2015



GMC INSTRUMENTS

Camille Bauer Metrawatt AG
Aargauerstrasse 7
CH-5610 Wohlen / Switzerland
Phone: +41 56 618 21 11
Telefax: +41 56 618 35 35
E-Mail: info@cbmag.com
<http://www.camillebauer.com>

 **CAMILLE BAUER**
Rely on us.

Legal information

Warning notices

In this document warning notices are used, which you have to observe to ensure personal safety and to prevent damage to property. Depending on the degree of danger the following symbols are used:



If the warning notice is not followed death or severe personal injury **will** result.



If the warning notice is not followed damage to property or severe personal injury **may** result.



If the warning notice is not followed the device **may** be damaged or **may** not fulfill the expected functionality.

Qualified personnel

The product described in this document may be handled by personnel only, which is qualified for the respective task. Qualified personnel have the training and experience to identify risks and potential hazards when working with the product. Qualified personnel are also able to understand and follow the given safety and warning notices.

Intended use

The product described in this document may be used only for the application specified. The maximum electrical supply data and ambient conditions specified in the technical data section must be adhered. For the perfect and safe operation of the device proper transport and storage as well as professional assembly, installation, handling and maintenance are required.

Disclaimer of liability

The content of this document has been reviewed to ensure correctness. Nevertheless it may contain errors or inconsistencies and we cannot guarantee completeness and correctness. This is especially true for different language versions of this document. This document is regularly reviewed and updated. Necessary corrections will be included in subsequent version and are available via our webpage <http://www.camillebauer.com>.

Feedback

If you detect errors in this document or if there is necessary information missing, please inform us via e-mail to: customer-support@camillebauer.com

Contents

1. Introduction	5
1.1 Purpose of this document.....	5
1.2 Scope of supply.....	5
1.3 Further documents	5
2. Safety notes	6
3. Device overview.....	6
3.1 Brief description.....	6
3.2 Available measurement data	6
4. Mechanical mounting.....	7
4.1 Panel cutout	7
4.2 Mounting of the device	7
4.3 Demounting of the device.....	7
5. Electrical connections	8
5.1 General safety notes	8
5.2 Terminal assignments of the I/O extensions	9
5.3 Possible cross sections and tightening torques	9
5.4 Inputs	10
5.5 Power supply.....	19
5.6 Relays	19
5.7 Digital inputs and outputs	19
5.8 Analog outputs	20
5.9 Modbus interface RS485	21
6. Commissioning.....	22
6.1 Parametrization of the device functionality.....	22
6.2 Installation check.....	23
6.3 Simulation of I/Os	23
7. Operating the device	24
7.1 Operating elements	24
7.2 Selecting the information to display	24
7.3 Measurement displays and used symbols	25
7.4 Alarming.....	27
7.5 Resetting measurements.....	29
7.6 Setting / resetting of meter contents	29
7.7 Configuration.....	29
7.8 Timeouts	30
8.1 Calibration and new adjustment	31
8.2 Cleaning.....	31
8.3 Battery.....	31
8.4 Disposal	31
9. Technical data	32
10. Dimensional drawings	38

Annex	39
A Description of measured quantities	39
A1 Basic measurements.....	39
A2 Harmonic analysis.....	43
A3 System imbalance.....	44
A4 Mean values and trend.....	45
A5 Meters.....	46
B Display matrices	47
B0 Used abbreviations for the measurements	47
B1 Display matrices for single phase system.....	51
B2 Display matrices for split-phase (two-phase) systems	52
B3 Display matrices for 3-wire system, balanced load.....	53
B4 Display matrices for 3-wire systems, unbalanced load	54
B5 Display matrices for 3-wire systems, unbalanced load, Aron.....	55
B6 Display matrices for 4-wire system, balanced load.....	56
B7 Display matrices for 4-wire systems, unbalanced load	57
B8 Display matrices for 4-wire system, unbalanced load, Open-Y.....	58
C Logic functions	Fehler! Textmarke nicht definiert.
D Declaration of conformity	60
D1 CE conformity	60
D2 FCC statement.....	61
INDEX	62

1. Introduction

1.1 Purpose of this document

This document describes the universal measurement device for heavy-current quantities SINEAX AM2000. It is intended to be used by:

- Installation personnel and commissioning engineers
- Service and maintenance personnel
- Planners

Scope

This handbook is valid for all hardware versions of the AM2000. Some of the functions described in this document are available only, if the necessary optional components are included in the device.

Required knowledge

A general knowledge in the field of electrical engineering is required. For assembly and installation of the device knowledge of applicable national safety regulations and installation standard is required.

1.2 Scope of supply



- Measurement SINEAX AM2000
- Safety instructions (multiple languages)
- Connection set: 2 mounting clamps

1.3 Further documents

The following documents are provided electronically via <http://www.camillebauer.com/am2000-en> :

- Safety instructions SINEAX AM2000
- Data sheet SINEAX AM2000
- Modbus basics: General description of the communication protocol
- Modbus interface SINEAX AM2000: Register description of Modbus/RTU communication via RS-485

2. Safety notes

		Device may only be disposed in a professional manner !
---	---	--

The installation and commissioning should only be carried out by trained personnel.

Check the following points before commissioning:

- that the maximum values for all the connections are not exceeded, see "Technical data" section,
- that the connection wires are not damaged, and that they are not live during wiring,
- that the power flow direction and the phase rotation are correct.

The instrument must be taken out of service if safe operation is no longer possible (e.g. visible damage). In this case, all the connections must be switched off. The instrument must be returned to the factory or to an authorized service dealer.

It is forbidden to open the housing and to make modifications to the instrument. The instrument is not equipped with an integrated circuit breaker. During installation check that a labeled switch is installed and that it can easily be reached by the operators.

Unauthorized repair or alteration of the unit invalidates the warranty.

3. Device overview

3.1 Brief description

The SINEAX AM2000 is a comprehensive instrument for the universal measurement and monitoring in power systems. A full parameterization of all functions of the AM2000 is possible directly at the device. The universal measurement system of the device may be used directly for any power system, from single phase up to 4-wire unbalanced networks, without hardware modifications.

Using additional, optional components the opportunities of the AM2000 may be extended. You may choose from I/O extensions or Modbus/RTU communication interface. The nameplate on the device gives further details about the present version.

3.2 Available measurement data

The SINEAX AM2000 provides measurements in the following subcategories:

- Instantaneous values: Present TRMS values and associated min/max values
- Energy consumption: Power mean-values with trend and history as well as energy meters
- Harmonics: Total harmonic distortion THD/TDD, individual harmonics and their maximum values
- Phasor diagram: Graphical overview of all current and voltage phasors
- Alarms: State display of monitored events

4. Mechanical mounting

► The AM2000 is designed for panel mounting



Please ensure that the operating temperature limits are not exceeded when determining the place of mounting (place of measurement):

-10 ... 55°C

4.1 Panel cutout

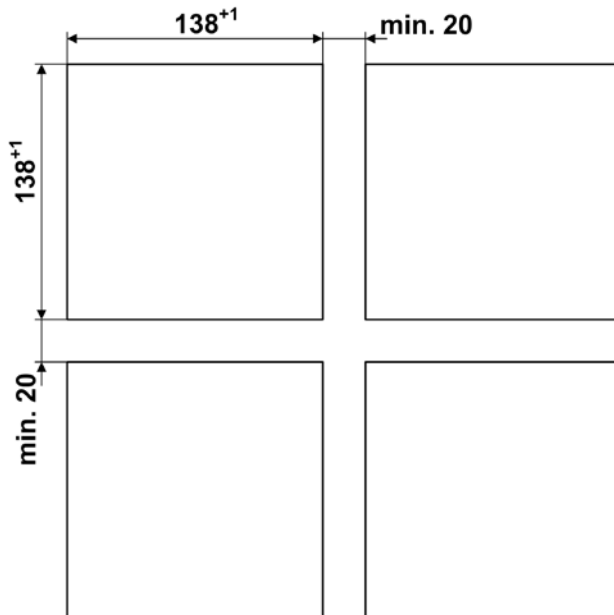

Dimensional drawing AM2000:

[See section 10](#)

4.2 Mounting of the device

The device is suitable for panel widths up to 8mm.

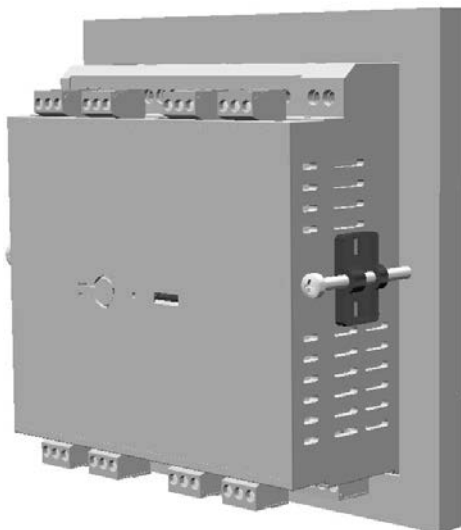

- Slide the device into the cutout from the outside
- From the side slide in the mounting clamps into the intended openings and pull them back about 2 mm
- Tighten the fixation screws until the device is tightly fixed with the panel

4.3 Demounting of the device

The demounting of the device may be performed only if all connected wires are out of service. Remove all plug-in terminals and all connections of the current and voltage inputs. Pay attention to the fact, that current transformers must be shorted before removing the current connections to the device. Then demount the device in the opposite order of mounting (4.2).

5. Electrical connections



Ensure under all circumstances that the leads are free of potential when connecting them !

5.1 General safety notes



Please observe that the data on the type plate must be adhered to !

The national provisions have to be observed in the installation and material selection of electric lines, e.g. in Germany VDE 0100 "Conditions concerning the erection of heavy current facilities with rated voltages below 1000 V"!

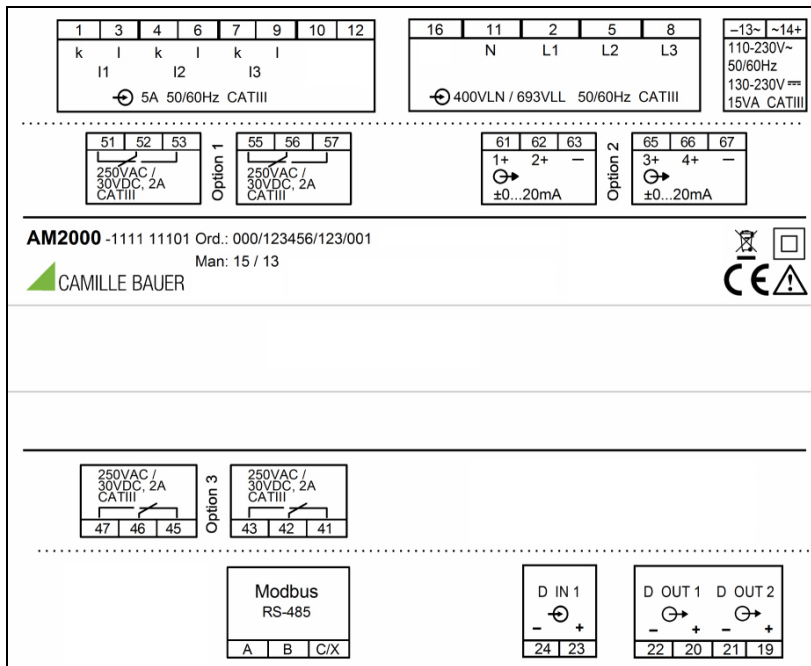

Nameplate of a device with

- Modbus/RTU interface
- 4 relay outputs
- 4 analog outputs

Symbol	Meaning
	Device may only be disposed of in a professional manner!
	Double insulation, device of protection class 2
	CE conformity mark. The device fulfills the requirements of the applicable EC directives. See declaration of conformity .
	Caution! General hazard point. Read the operating instructions.
	General symbol: Input
	General symbol: Output
CAT III	Measurement category CAT III for current / voltage inputs, power supply and relay outputs

5.2 Terminal assignments of the I/O extensions

Function	Option 1	Option 2	Option 3	Option 4
2 relay outputs	1.1: 51,52,53 1.2: 55,56,57	2.1: 61,62,63 2.2: 65,66,67	3.1: 41,42,43 3.2: 45,46,47	4.1: 31,32,33 4.2: 35,36,37
2 analog outputs	1.1: 51(+), 53(-) 1.2: 52(+), 53(-)	2.1: 61(+), 63(-) 2.2: 62(+), 63(-)	3.1: 41(+), 43(-) 3.2: 42(+), 43(-)	4.1: 31(+), 33(-) 4.2: 32(+), 33(-)
4 analog outputs	1.1: 51(+), 53(-) 1.2: 52(+), 53(-) 1.3: 55(+), 57(-) 1.4: 56(+), 57(-)	2.1: 61(+), 63(-) 2.2: 62(+), 63(-) 2.3: 65(+), 67(-) 2.4: 66(+), 67(-)	3.1: 41(+), 43(-) 3.2: 42(+), 43(-) 3.3: 45(+), 47(-) 3.4: 46(+), 47(-)	4.1: 31(+), 33(-) 4.2: 32(+), 33(-) 4.3: 35(+), 37(-) 4.4: 36(+), 37(-)

5.3 Possible cross sections and tightening torques

Inputs L1(2), L2(5), L3(8), N(11), I1(1-3), I2(4-6), I3(7-9), power supply (13-14)

Single wire

1 x 0,5 ... 6.0mm² or 2 x 0,5 ... 2.5mm²

Multewire with end splices

1 x 0,5 ... 4.0mm² or 2 x 0,5 ... 2.5mm²

Tightening torque

0.5...0.6Nm resp. 4.42...5.31 lbf in

I/O's, relays, RS485 connector (A, B, C/X)

Single wire

1 x 0.5 ... 2.5mm² or 2 x 0.5 ... 1.0mm²

Multewire with end splices

1 x 0.5 ... 2.5mm² or 2 x 0.5 ... 1.5mm²

Tightening torque

0.5...0.6Nm resp. 4.42...5.31 lbf in

5.4 Inputs



All voltage measurement inputs must originate at circuit breakers or fuses rated 5 Amps or less. This does not apply to the neutral connector. You have to provide a method for manually removing power from the device, such as a clearly labeled circuit breaker or a fused disconnect switch.

When using **voltage transformers** you have to ensure that their secondary connections never will be short-circuited.



No fuse may be connected upstream of the **current measurement inputs** !

When using **current transformers** their secondary connectors must be short-circuited during installation and before removing the device. Never open the secondary circuit under load.

The connection of the inputs depends on the configured system (connection type).

Single-phase AC mains

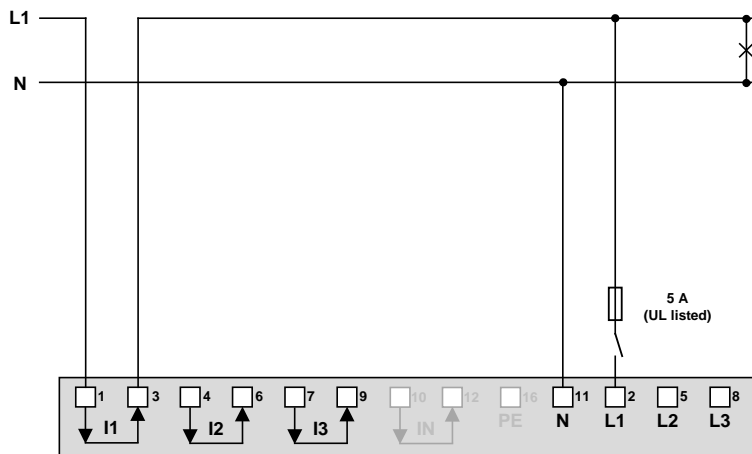

Direct connection

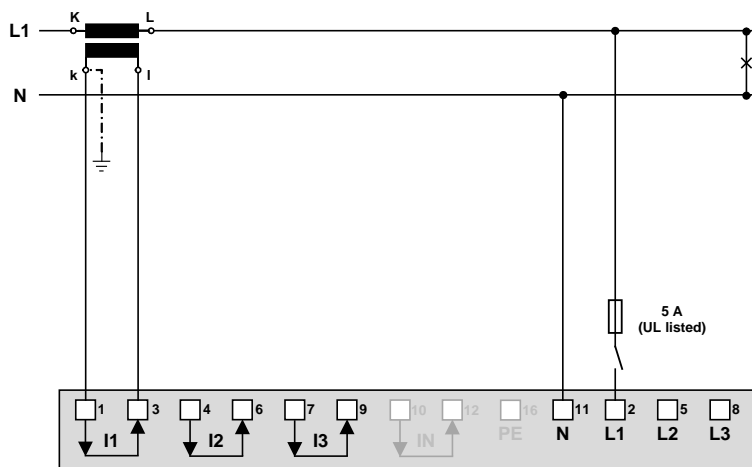

With current transformer

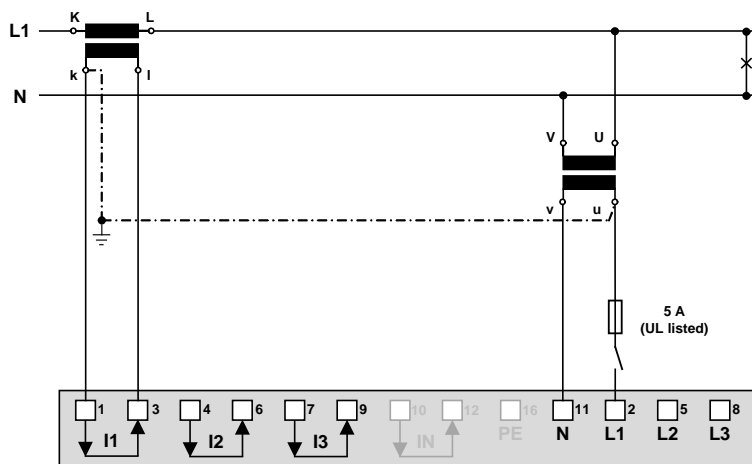

With current and voltage transformer

Three wire system, balanced load, current measurement via L1

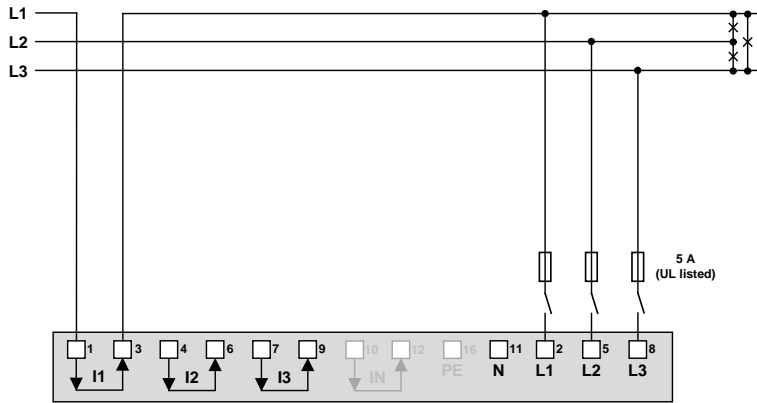

Direct connection

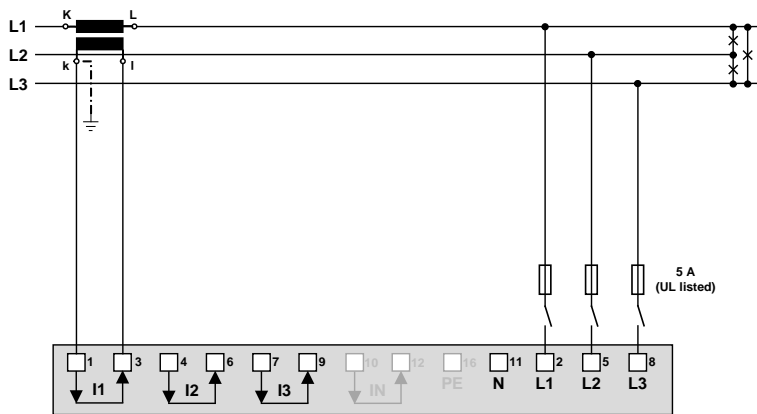

With current transformer

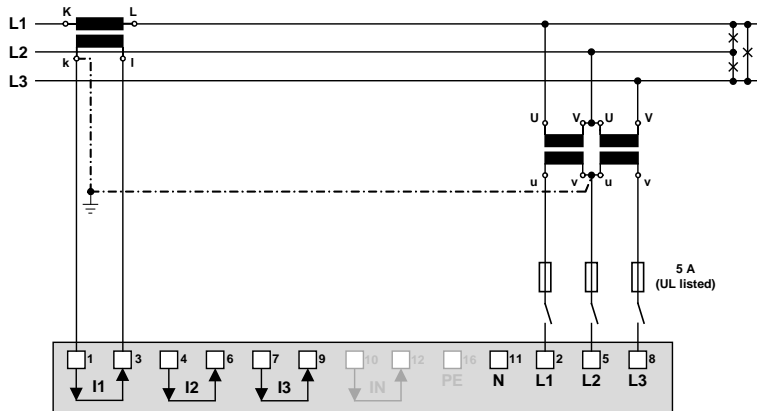

With current and voltage transformers

In case of current measurement via L2 or L3 connect voltages according to the following table:

Current	Terminals		L1	L2	L3
L2	I1-1	I1-3	L2	L3	L1
L3	I1-1	I1-3	L3	L1	L2

 By rotating the voltage connections the measurements U12, U23 and U31 will be assigned interchanged !

Four wire system, balanced load, current measurement via L1

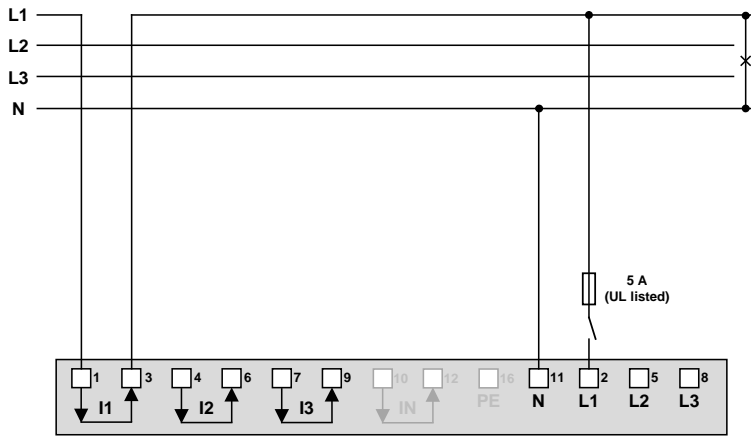

Direct connection

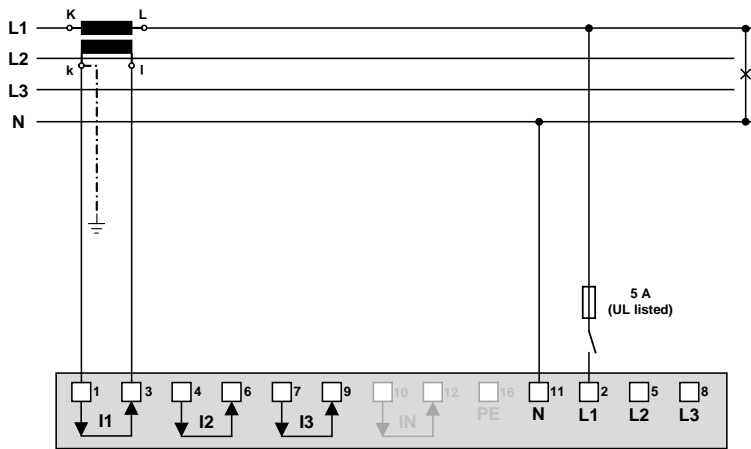

With current transformer

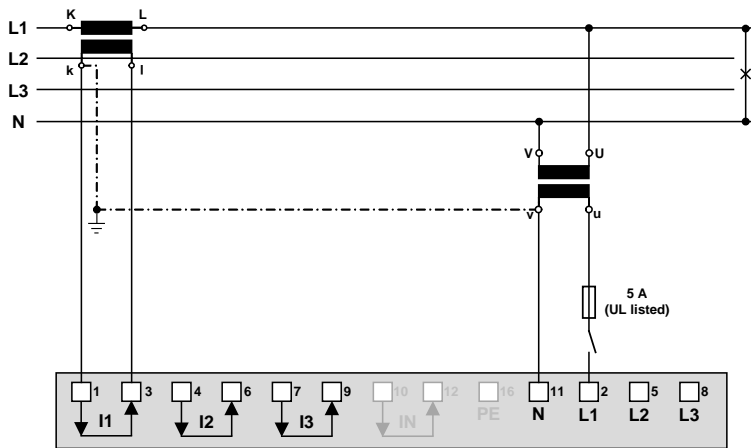

With current and voltage transformer

In case of current measurement via L2 or L3 connect voltages according to the following table:

Current	Terminals		L1	N
L2	I1-1	I1-3	L2	N
L3	I1-1	I1-3	L3	N

Three wire system, unbalanced load

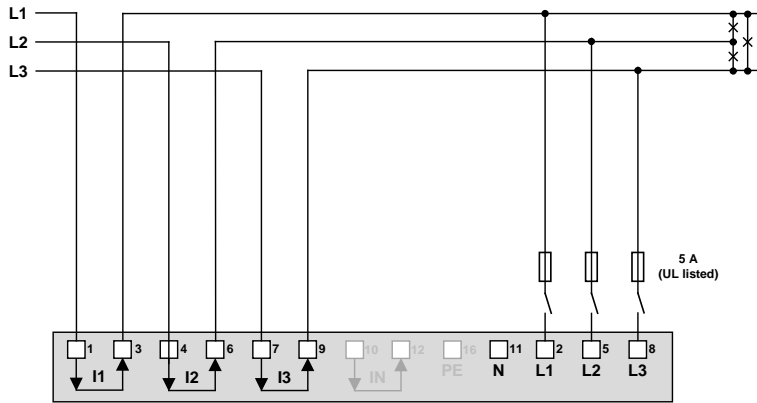

Direct connection

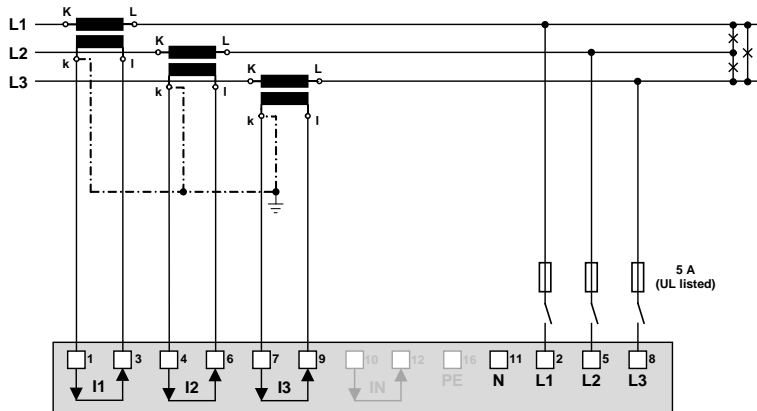

With current transformers

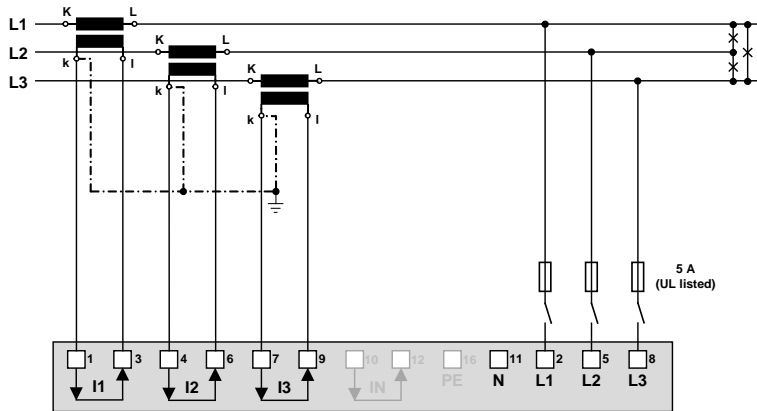

With current and 3 single-pole isolated voltage transformers

Four wire system, unbalanced load

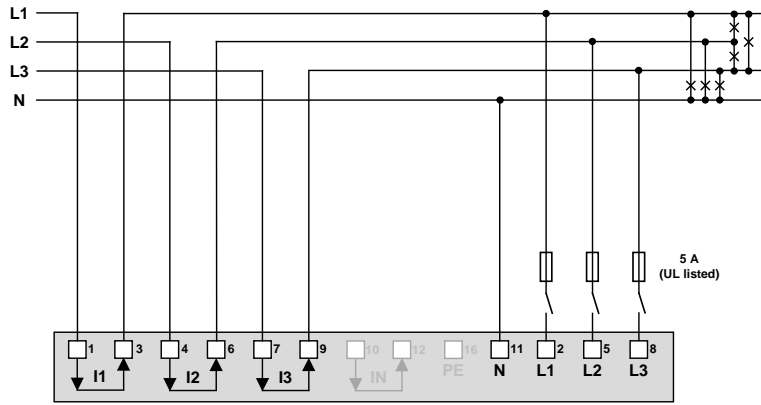

Direct connection

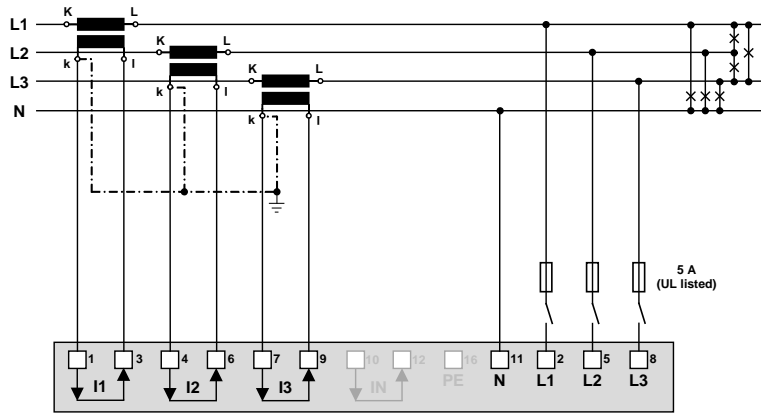

With current transformer

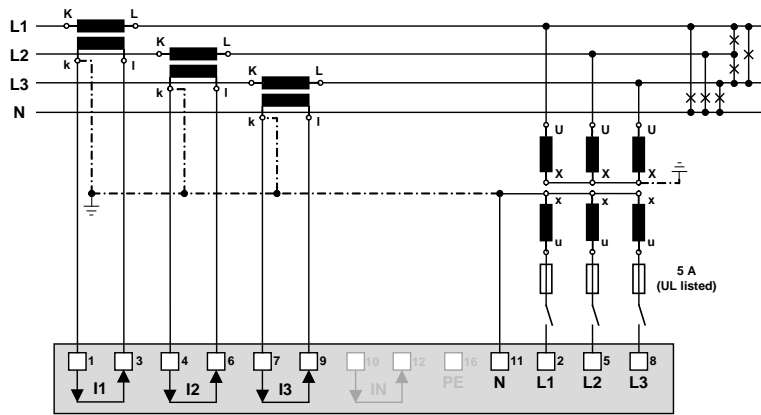

With current and 3 single-pole isolated voltage transformers

Four wire system, unbalanced load, Open-Y

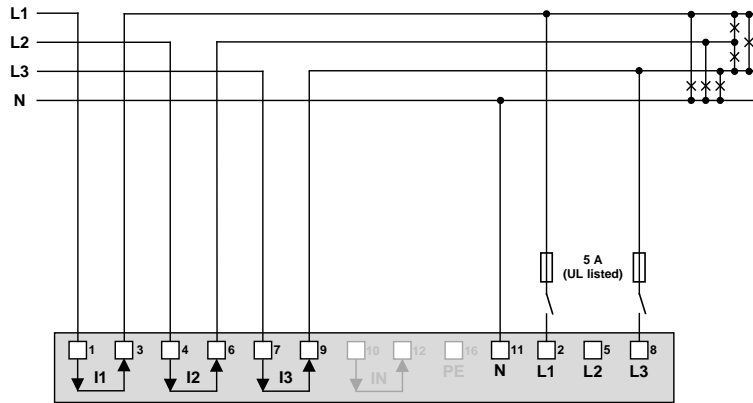

Direct connection

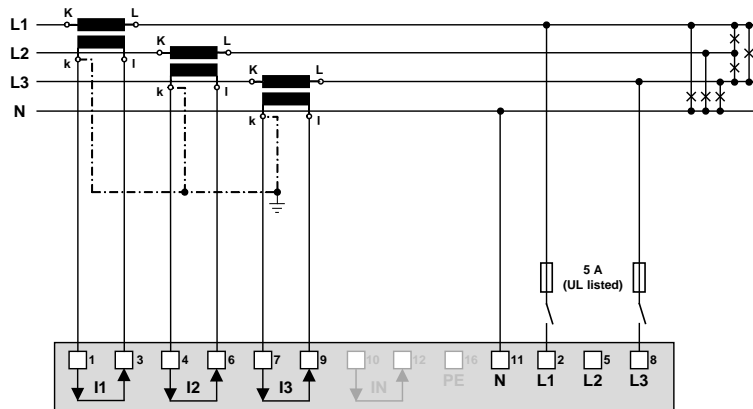

With current transformers

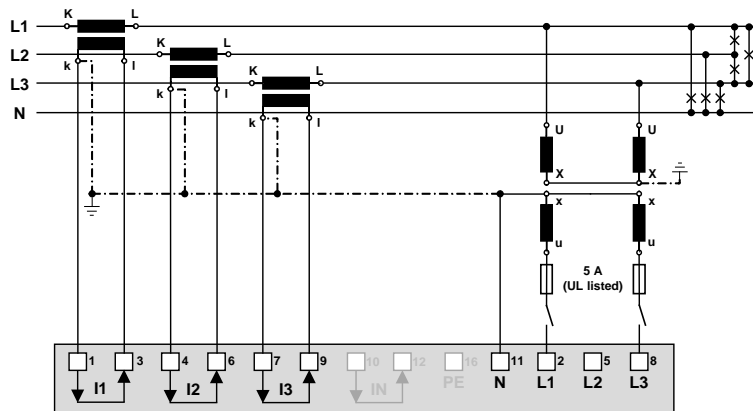

With current and 2 single-pole isolated voltage transformers

Split-phase ("two phase system"), unbalanced load

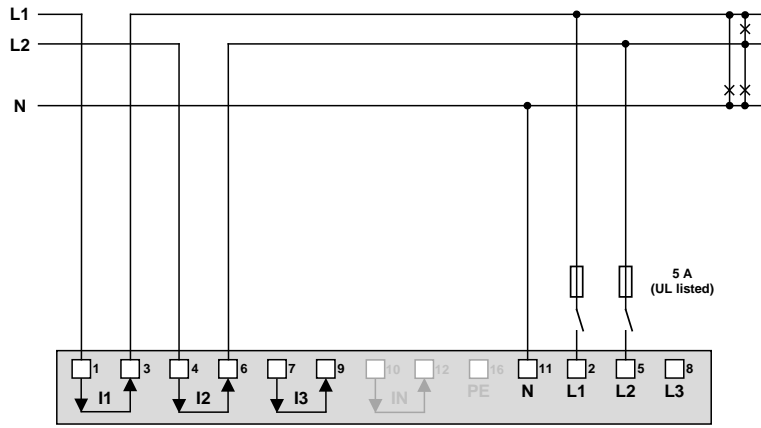

Direct connection

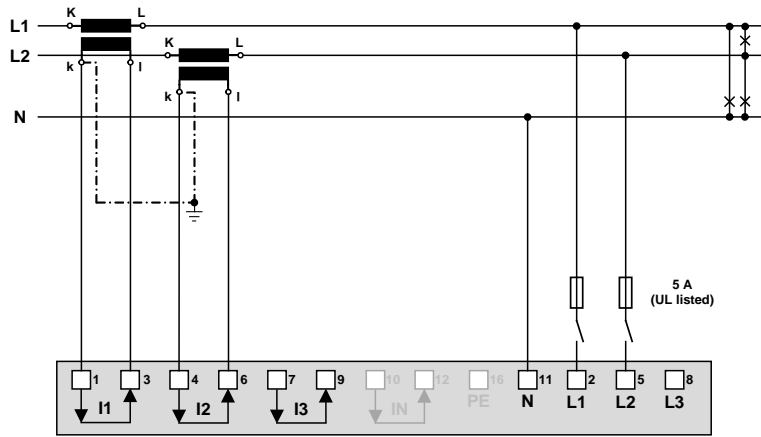

With current transformers

5.5 Power supply



A marked and easily accessible current limiting switch has to be arranged in the vicinity of the device for turning off the power supply. Fusing should be 10 Amps or less and must be rated for the available voltage and fault current.

5.6 Relays



When the device is switched off the relay contacts are de-energized, but dangerous voltages may be present.

Relays are available for device versions with corresponding I/O extensions only.

I/O extension y	x
1	5
2	6
3	4
4	3

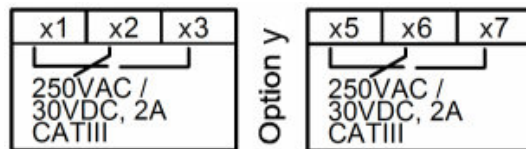

5.7 Digital inputs and outputs

For the digital inputs / outputs an external power supply of 12 / 24V DC is required.



The power supply shall not exceed 30V DC !

A digital input and two digital outputs are provided as a standard.

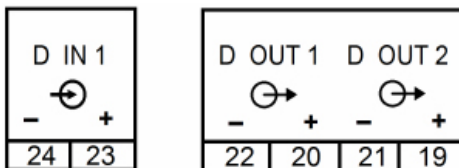

Usage as digital input

- ▶ Clock synchronization
- ▶ Synchronization of billing intervals in accordance with energy provider
- ▶ Meter tariff switching

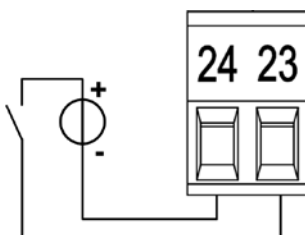

Technical data

Input current	< 7,0 mA
Logical ZERO	- 3 up to + 5 V
Logical ONE	8 up to 30 V

Usage as digital output

- ▶ Alarm output
- ▶ State reporting
- ▶ Pulse output to an external counter (acc. EN62053-31)

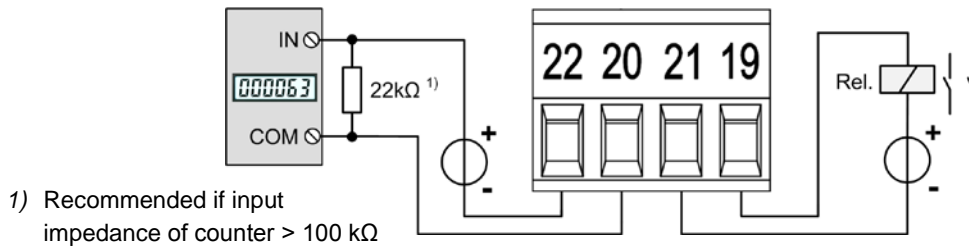

Driving a counter mechanism

The width of the energy pulses can be selected, but have to be adapted to the counter mechanism.

Electro mechanical meters typically need a pulse width of 50...100ms.

Electronic meters are partly capable to detect pulses in the kHz range. There are the types NPN (active negative edge) and PNP (active positive edge). For the AM2000 a PNP type is required. The pulse width has to be at least 30ms (acc. EN62053-31). The delay between to pulses corresponds at least to the pulse width. The smaller the pulse width, the higher the sensitivity to disturbances.

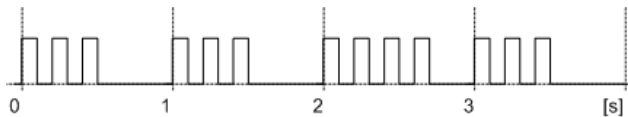

Driving a relay

Rated current	50 mA (60 mA max.)
Switching frequency (S0)	≤ 20 Hz
Leakage current	0,01 mA
Voltage drop	< 3 V
Load capacity	400 Ω ... 1 MΩ

5.8 Analog outputs

Analog outputs are available for devices with corresponding I/O extensions only. See nameplate.

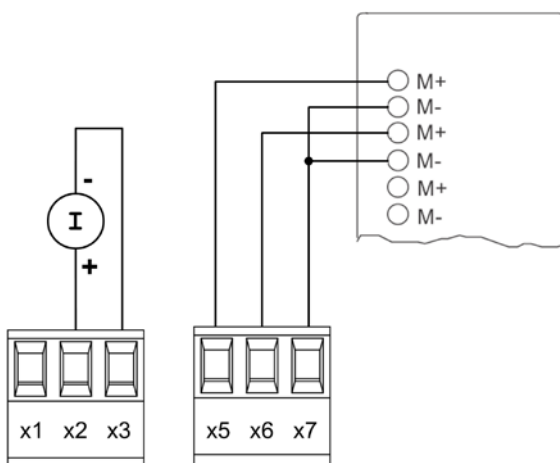

Connection to an analog input card of a PLC or a control system

The AM2000 is an isolated measurement device. The particular outputs are not galvanically isolated. To reduce the influence of disturbances shielded a twisted-pair cables should be used. The shield should be connected to earth on both opposite ends. If there a potential differences between the ends of the cable the shield should be earthed on one side only to prevent from equalizing currents.

Under all circumstances consider as well appropriate remarks in the instruction manual of the system to connect.

5.9 Modbus interface RS485

Via the optional Modbus interface measurement data may be provided for a superior system. However, the Modbus interface cannot be used for device parameterization.

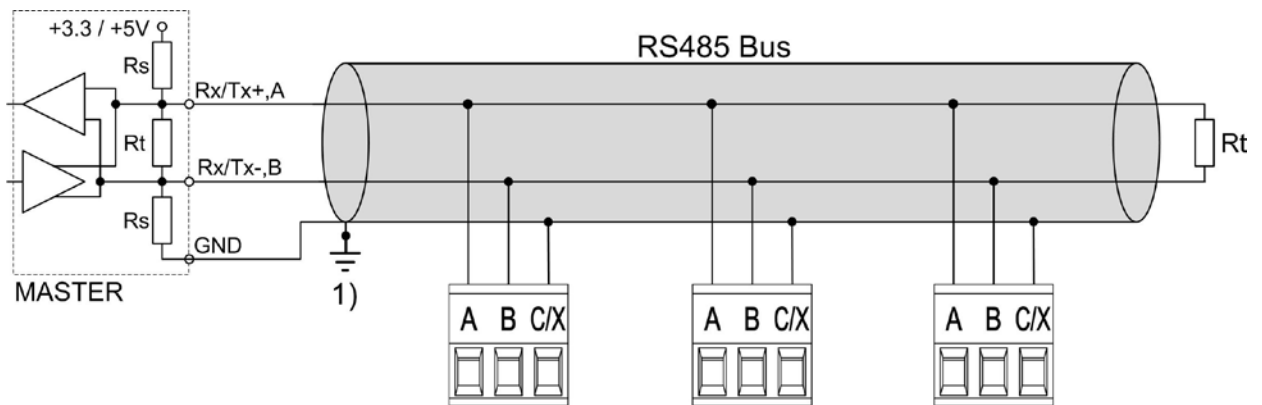

1) One ground connection only.
This is possibly made within the master (PC).

Rt: Termination resistors: 120 Ω each
for long cables (> approx. 10 m)

Rs: Bus supply resistors,
390 Ω each

The signal wires (A, B) have to be twisted. GND (C/X) can be connected via a wire or via the cable screen. In disturbed environments shielded cables must be used. Supply resistors (Rs) have to be present in bus master (PC) interface. Stubs should be avoided when connecting the devices. A pure daisy chain network is ideal.

You may connect up to 32 Modbus devices to the bus. A proper operation requires that all devices connected to the bus have equal communication settings (baud rate, transmission format) and unique Modbus addresses.

The bus system is operated half duplex and may be extended to a maximum length of 1200 m without repeater.

6. Commissioning



Before commissioning you have to check if the connection data of the device match the data of the plant (see nameplate).

If so, you can start to put the device into operation by switching on the power supply and the measurement inputs.

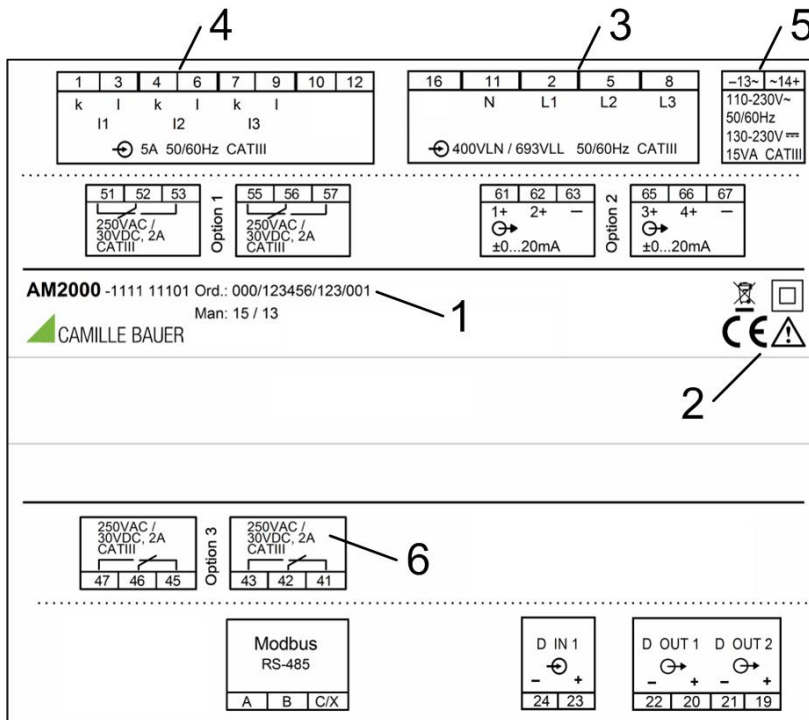

Measurement input

- Input voltage
- Input current
- System frequency

- 1 Works no.
- 2 Test and conformity marks
- 3 Assignment voltage inputs
- 4 Assignment current inputs
- 5 Assignment power supply
- 6 Load capacity relay outputs

6.1 Parametrization of the device functionality

A full parameterization of all functions of the device is possible directly at the device. See: [Configuration](#)

6.2 Installation check

By means of the phasor diagram the correct connection of the current and voltage inputs can be checked. In this diagram a technical visualization of the current and voltage phasors is shown, using a counter-clockwise rotation.

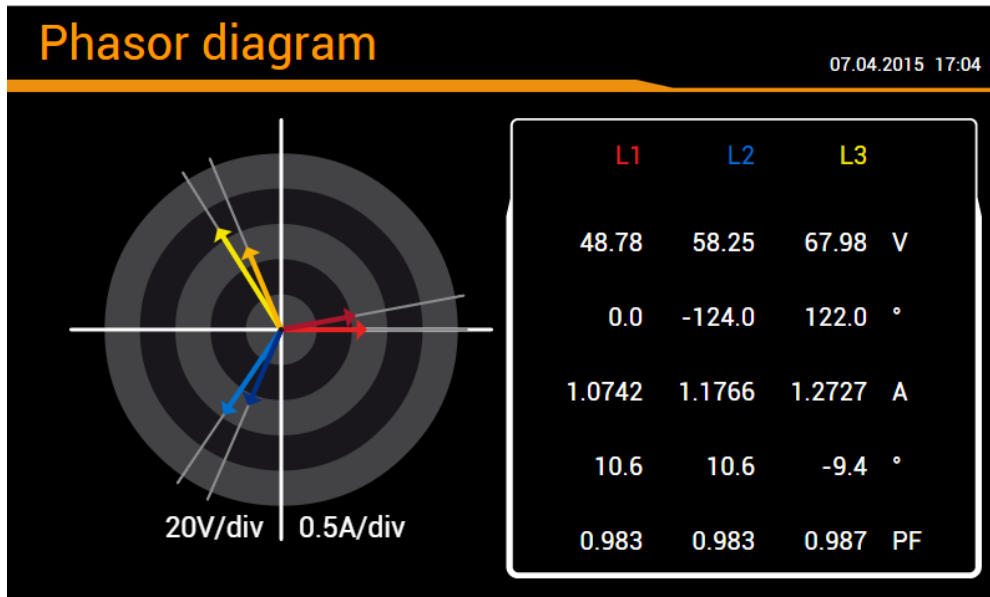

6.3 Simulation of I/Os

To check if subsequent circuits will work properly with the measurement data provided by the device, using the service menu all analog, digital and relay outputs may be simulated, by predefining any output value resp. discrete state.

7. Operating the device

7.1 Operating elements



Operation is performed by means of 6 keys:

- 4 keys for **navigation** (◀, ▲, ▼, ▶) and for the selection of values
- OK for **selection** or confirmation
- ESC for **menu display**, terminate or cancel

The **main function** of the operating keys changes in some measurement displays, during parameterization and in service functions. The valid functionality of the keys is then shown in a help bar.

7.2 Selecting the information to display



Information selection is performed via menu. Some menu items are direct selections, other menu items contain up to two further menu levels.

Displaying the menu

Press **ESC**. Each time the key is pressed a change to a higher menu level is performed, if present.

Displaying information





The menu item chosen using ▲, ▼ can be selected using **OK**. Repeat the procedure in possible submenus until the required information is displayed.

Closing the menu



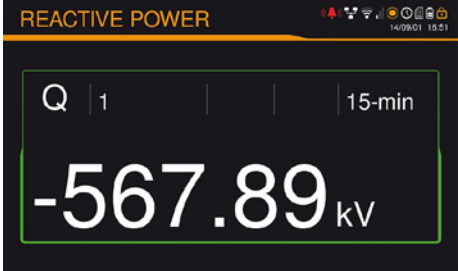



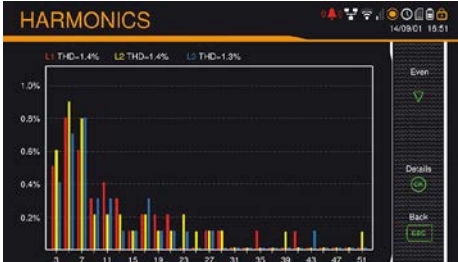

After 2 min. without interaction the menu is automatically closed and the last active measurement display is shown.

7.3 Measurement displays and used symbols

For displaying measurement information the device uses both numerical and numerical-graphical measurement displays.

Examples	Measurement information
 <p>REACTIVE POWER</p> <p>Q 1 15-min</p> <p>-567.89 kV</p>	1 measured quantity
 <p>VOLTAGE</p> <p>U 1N TRMS</p> <p>11:23:05 20.08.2014 232.12 V</p> <p>08:06:14 20.08.2014 210.82 V</p> <p>U 1N 15-min</p> <p>230.52 V</p>	2 measured quantities
 <p>MIXED 2</p> <p>I 1 15-min 936.83 A</p> <p>U TRMS 11:23:05 20.08.2014 10.627 kV</p> <p>U 1N 08:06:14 20.08.2014 9.823 kV</p> <p>Q 1 15-min 188.41 Mvar</p> <p>Q TRMS 11:23:05 20.08.2014 236.83 Mvar</p> <p>Q 1 08:06:14 20.08.2014 145.26 Mvar</p>	4 measured quantities
 <p>MIXED 1</p> <p>U 1N TRMS 11:23:05 20.08.2014 123.89 V</p> <p>U 1N TRMS 08:06:14 20.08.2014 124.78 V</p> <p>U 1N TRMS 08:06:14 20.08.2014 78.34 V</p> <p>Q 1 15-min 567.89 Mvar</p> <p>PF TRMS 0.891</p> <p>P 1 15-min 11:23:05 20.08.2014 565.54 MW</p> <p>P 1 15-min 11:23:05 20.08.2014 4565.5 A</p> <p>Q 3 15-min 6712.89 Mvarh</p> <p>P 1 15-min 823.14 Mvar</p>	2x4 measured quantities
 <p>HARMONICS</p> <p>L1 THD=1.4% L2 THD=1.4% L3 THD=1.3%</p> <p>Bar chart showing THD values for various harmonics (3, 5, 7, 9, 11, 13, 15, 17, 19, 21, 23, 25, 27, 29, 31, 33, 35, 37, 39, 41, 43, 45, 47, 49, 51).</p> <p>Even</p> <p>Details</p> <p>Back</p> <p>ESC</p>	Graphical measurement display Further examples

For defining a measurement uniquely, a short description (z.B. U_{1N}) and a unit (z.B. V) are not sufficient. Therefore additional symbols are used for defining the measurement type:

	Mean-value		Inductive load
	Mean-value trend		Capacitive load
	Bimetal function (current)		Maximum value
	Energy demand		Minimum value
	Energy supply	TRMS	True root-mean-square value
Σ HT	Meter (high tariff)	RMS	Root-mean square value (e.g. fundamental or harmonic content only)
\emptyset	Average value (arithmetic mean-value)		

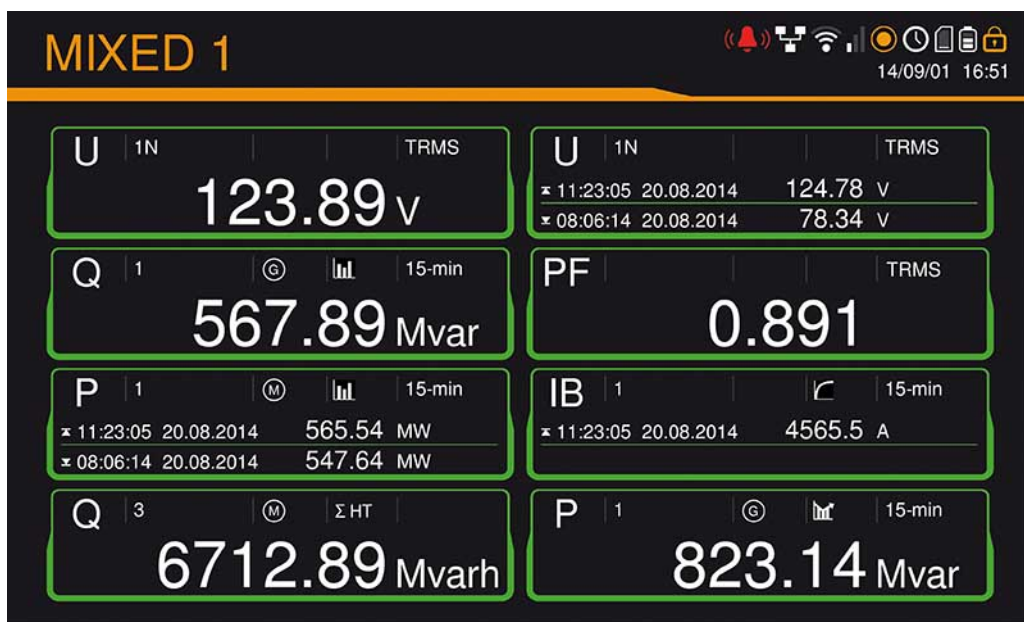

Meaning

Voltage U_{1N} , TRMS <i>Instantaneous value</i>	Voltage U_{1N} , TRMS <i>Min/Max value of instantaneous value with time</i>
Reactive power Q_1 (energy supply only) <i>15-min mean-value</i>	Power factor system, TRMS <i>Instantaneous value</i>
Active power P_1 (energy demand only) <i>Min/Max of 15-min mean-value</i>	Bimetal current I_{B1} , Response time 15-min <i>Slave pointer value with time</i>
Reactive energy Q_3 (energy demand only), high tariff <i>Present meter content</i>	Wirkleistung P_1 (nur Energiebezug) <i>Trend of 15-min mean-value</i>

7.4 Alarming

The alarming concept is very flexible. Depending on the user requirements simple or more advanced monitoring tasks may be realized.

- The simplest approach is to define a **limit value** and to select a digital output to use the limit state as its source.
- A more advanced monitoring task may be realized using **monitoring functions**: Up to 3 logic inputs may be logically combined, as well a digital output can be used to output the state of the monitoring function. The state of each monitoring functions is also displayed in the alarm list.
- In addition all monitoring function MFx may be combined to build a summary alarm. The state of this summary alarm is displayed in the upper right corner of the display.

Monitoring functions

By means of monitoring functions the user can define an extended condition monitoring, e.g. for triggering an over-current alarm, if one of the phase currents exceeds a limit value.

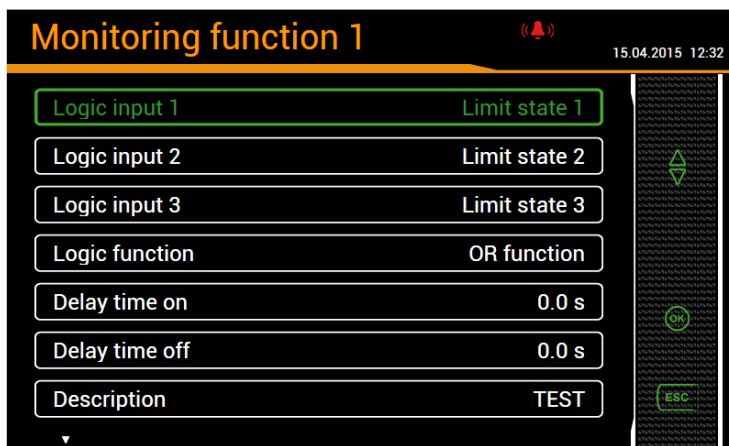

Logic inputs

Up to three states of limit values, logic inputs or other monitoring functions.

Logic function

For the logical combination of the inputs you can choose AND, NAND, OR, NOR, DIRECT and INVERT. These logical functions are described in [Appendix C](#).

Possible follow-up actions

- Driving a logic output. The assignment of the monitoring function to a digital output / relay is done via the settings of the corresponding output.
- State visualization in the alarm list
- Combining the states of all monitoring functions to create a summary alarm

Description

The associated description will be used for visualization on the display or as a list text

Delay time ON

The condition must remain stable at least this time until it is forwarded

Delay time OFF

Waiting time until a condition, which does not longer exist, is reset

Summary alarm

The summary alarm combines the states of all monitoring function MFx to a superior alarm-state of the overall unit. For each monitoring function you may select if it is used for building the summary alarm state. If at least one of the enabled functions is in the alarm state, the summary alarm is also in the alarm state.

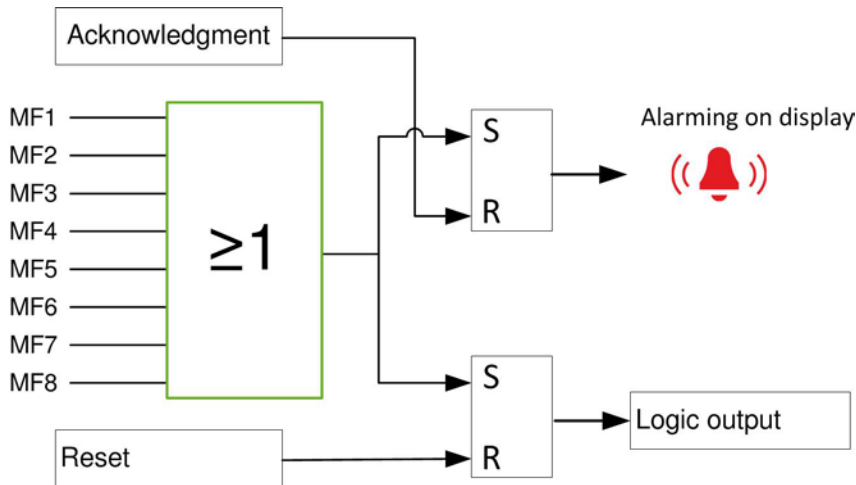

Alarm display

The symbol arranged in the status bar signalizes if alarms are active or not.

Acknowledgment. By acknowledging the summary alarm, the user confirms that he has recognized that an alarm state occurred. The acknowledgment is done automatically as soon as the user selects the alarm list to be displayed or if the alarm state no longer exists. By acknowledging only the flashing of the alarm symbol stops, the symbol itself remains statically displayed until all monitoring functions are no longer in the alarm state.

Logic output

The summary alarm can drive an output. The assignment of the summary alarm to a digital output / relay is done via the settings of the corresponding output.

Reset: The state of the output used for the summary alarm can be reset, even if there is still an alarm active. So, for example a horn activated via summary alarm can be deactivated. A reset may be performed via display, a digital input or via Modbus interface. The logic output becomes active again as soon as another monitoring function goes to the alarm state or if the same alarm becomes active again.

Alarm list



The logic output of the active summary alarm may be reset by means of the OK key.

7.5 Resetting measurements

The device provides minimum and maximum values of different measured quantities, which may be reset during operation. Reset may be performed in groups using the service menu.

Group	Values to be reset
1	Min/max values of voltages, currents and frequency
2	Min/max values of Power quantities (P,Q,Q(H0),D,S); min. load factors
3	Min/max values of power mean-values, bimetal slave pointers and free selectable mean-values
4	Maximum values of harmonic analysis: THD U/I, TDD I, individual harmonics U/I
5	All imbalance maximum values of voltage and current

7.6 Setting / resetting of meter contents

Meter contents may be individually set or reset during operation using the service menu.

7.7 Configuration

A full parameterization of the device can be performed via the menu settings. With the exception of the “*country and clock*” menu, all modifications will not take effect before the user accepts the query “Store configuration changes” when leaving the settings menu.

- Country and clock: time/date, date format, display language
- Display settings: Refresh rate, brightness, screen saver
- Measurement input: System type, nominal values of U/I/f, sense of rotation, quadrants
- Power mean-values: Interval time, synchronization source
- Free selectable mean-values: Measured quantity, interval time, synchronization source
- Standard meters: Tariff switching ON/OFF, meter resolution
- Free selectable meters: Basic quantity, tariff switching ON/OFF, meter resolution
- Limit values: Measured quantity, limit value for ON/OFF
- Digital input: Minimum pulse width, polarity
- Monitoring functions: Logic inputs 1...3, Logic function, switch-in delay, description text, classification
- Alarm module
- Digital outputs: Type, source, pulse width, polarity, number of pulses per unit
- Relay outputs: Type of output, source
- Analog outputs: Type of output, source, transfer characteristic, upper/lower range limit
- Modbus interface settings: Baudrate, parity, number of stop bits, device address
- User settings
- Demo mode ON/OFF
- Device information texts

7.8 Timeouts

The device is designed to display measurements. So, any other procedure will be terminated after a certain time without user interaction and the last active measurement image will be shown again.

Menu timeout

A menu timeout takes effect after 2 min. without changing the present menu selection. It doesn't matter if the currently displayed menu is the main menu or a third sub-menu: The menu is closed and the last active measurement image is displayed again.

Configuration timeout

After 5 min. without interaction in a parameter selection or during entering a value in the settings menu, the active configuration step is closed and the associated parameter remains unchanged. The follow-up procedure depends on what you have done before:

- If the user did not change configuration parameters before the aborted step, the main menu will be displayed and the device starts to monitor a possible menu timeout.
- If the user changed configuration parameters before the aborted step, the query "Store configuration changes?" is shown. If the user does not answer this query within 2 min. this dialogue is closed: The changed configuration will be stored and activated and then the last active measurement image is displayed again.

8. Service, maintenance and disposal

8.1 Calibration and new adjustment

Each device is adjusted and checked before delivery. The condition as supplied to the customer is measured and stored in electronic form.

The uncertainty of measurement devices may be altered during normal operation if, for example, the specified ambient conditions are not met. If desired, in our factory a calibration can be performed, including a new adjustment if necessary, to assure the accuracy of the device.

8.2 Cleaning

The display and the operating keys should be cleaned in regular intervals. Use a dry or slightly moist cloth for this.



Damage due to detergents

Detergents may not only affect the clearness of the display but also can damage the device. Therefore, do not use detergents.

8.3 Battery

The device contains a battery for buffering the internal clock. It cannot be changed by the user. The replacement can be done at the factory only.

8.4 Disposal

The product must be disposed in compliance with local regulations. This particularly applies to the built-in battery.

9. Technical data

Inputs

Nominal current:	adjustable 1...5 A
Maximum:	7.5 A (sinusoidal)
Consumption:	$\leq I^2 \times 0.01 \Omega$ per phase
Overload capacity:	10 A continuous 100 A, 5 x 1 s, interval 300 s
Nominal voltage:	57.7...400 V _{LN} , 100...693 V _{LL}
Maximum:	480 V _{LN} , 832 V _{LL} (sinusoidal)
Consumption:	$\leq U^2 / 1.54 M\Omega$ per phase
Impedance:	1.54 M Ω per phase
Overload capacity:	480 V _{LN} , 832 V _{LL} continuous 800 V _{LN} , 1386 V _{LL} , 10 x 1 s, interval 10s
Systems:	Single phase Split phase (2-phase system) 3-wire, balanced load 3-wire, unbalanced load 3-wire, unbalanced load, Aron connection 4-wire, balanced load 4-wire, unbalanced load 4-wire, unbalanced load, Open-Y
Nominal frequency:	45...50...55Hz or 55...60...65Hz, configurable
Measurement TRMS:	Up to the 60 th harmonic

Measurement uncertainty

Reference conditions: Acc. IEC/EN 60688, ambient 15...30°C, sinusoidal input signals (form factor 1.1107), no fixed frequency for sampling, measurement time 200ms (10 cycles at 50Hz, 12 cycles at 60Hz)

Voltage, current:	$\pm 0,2\%$ ^{1) 2)}
Power:	$\pm 0,5\%$ ^{1) 2)}
Power factor:	$\pm 0,2^\circ$
Frequency:	± 0.01 Hz
Imbalance U, I:	$\pm 0.5\%$
Harmonics:	$\pm 0.5\%$
THD U, I:	$\pm 0.5\%$
Active energy:	Class 1, EN 62053-22
Reactive energy:	Class 2, EN 62053-23

Measurement with fixed system frequency:

General	\pm Basic uncertainty x (F _{konfig} -F _{ist}) [Hz] x 10
Imbalance U	$\pm 2\%$ up to ± 0.5 Hz
Harmonics	$\pm 2\%$ up to ± 0.5 Hz
THD, TDD	$\pm 3.0\%$ up to ± 0.5 Hz

¹⁾ Related to the nominal value of the basic quantity

²⁾ Additional uncertainty if neutral wire not connected (3-wire connections)

- Voltage, power: 0.1% of measured value; load factor: 0.1°
- Energy: Voltage influence x 2, angle influence x 2

Zero suppression, range limitations

The measurement of specific quantities is related to a pre-condition which must be fulfilled, that the corresponding value can be determined and sent via interface or displayed. If this condition is not fulfilled, a default value is used for the measurement.

Quantity	Condition	Default
Voltage	$U_x < 1\% U_{x_{nom}}$	0.00
Current	$I_x < 0,1\% I_{x_{nom}}$	0.00
PF	$S_x < 1\% S_{x_{nom}}$	1.00
QF, LF, $\tan\varphi$	$S_x < 1\% S_{x_{nom}}$	0.00
Frequency	voltage and/or current input too low ¹⁾	Nominal frequency
Voltage unbalance	$U_x < 5\% U_{x_{nom}}$	0.00
Current unbalance	mean value of phase currents $< 5\% I_{x_{nom}}$	0.00
Phase angle U	at least one voltage $U_x < 5\% U_{x_{nom}}$	120°
Harmonics U, THD-U	fundamental $< 5\% U_{x_{nom}}$	0.00

¹⁾ specific levels depends on the device configuration

Power supply

Nominal voltage:

via terminals 13-14

(see nameplate)

V1: 110...230V AC / 130...230V DC $\pm 15\%$ or

V2: 24...48V DC $\pm 15\%$ or

V3: 110...200V AC / 110...200V DC $\pm 15\%$

Consumption:

≤ 15 VA, depending on the device hardware used

I/O interface

Available inputs and outputs

Basic unit	- 1 digital input - 2 digital outputs
I/O extensions	Optional modules: - 2 relay outputs with changeover contacts OR - 2 bipolar analog outputs OR - 4 bipolar analog outputs

Up to 4 I/O extensions may be present in the device. Only one module can be equipped with analog outputs.

Analog outputs	via plug-in terminals
Linearization:	Linear, kinked
Range:	± 20 mA (24 mA max.), bipolar
Uncertainty:	$\pm 0.2\%$ of 20 mA
Burden:	$\leq 500 \Omega$ (max. 10 V / 20 mA)
Burden influence:	$\leq 0.2\%$
Residual ripple:	$\leq 0.4\%$
Response time:	220...420 ms

Relays	via plug-in terminals
Contact:	changeover contact, bistabil
Load capacity:	250 V AC, 2 A, 500 VA 30 V DC, 2 A, 60 W

Digital inputs	via plug-in terminals
Nominal voltage	12 / 24 V DC (30 V max.)
Logical ZERO	- 3 up to + 5 V
Logical ONE	8 up to 30 V

Digital outputs	via plug-in terminals
Nominal voltage	12 / 24 V DC (30 V max.)
Nominal current	50 mA (60 mA max.)
Load capability	400 Ω ... 1 M Ω

Interface

Modbus/RTU	via plug-in terminal (A, B, C/X)
Protocol:	Modbus/RTU
Physics:	RS-485, max. 1200m (4000 ft)
Baud rate:	9'600, 19'200, 38'400, 57'600, 115'200 Baud
Number of participants:	≤ 32

Internal clock (RTC)

Uncertainty:	± 2 minutes / month (15 up to 30°C)
Synchronization:	via synchronization pulse
Running reserve:	> 10 years

Ambient conditions, general information

Operating temperature:	–10 up to <u>15 up to 30</u> up to + 55°C
Storage temperature:	–25 up to + 70°C
Temperature influence:	0.5 x measurement uncertainty per 10 K
Long term drift:	0.5 x measurement uncertainty per year
Others:	Usage group II (EN 60 688)
Relative humidity:	< 95% no condensation
Altitude:	≤ 2000 m max.

Device to be used indoor only !

Mechanical attributes

Orientation:	Any
Housing material:	Polycarbonat (Makrolon)
Flammability class:	V-0 acc. UL94, non-dripping, free of halogen
Weight:	800 g
Dimensions:	Dimensional drawings

Vibration withstand (test according to DIN EN 60 068-2-6)

Acceleration:	± 5 g
Frequency range:	10 ... 150 ... 10 Hz, rate of frequency sweep: 1 octave/minute
Number of cycles:	10 in each of the 3 axes

Safety

The current inputs are galvanically isolated from each other

Protection class:	II (protective insulation, voltage inputs via protective impedance)
Pollution degree:	2
Protection:	IP54 (front), IP30 (housing), IP20 (terminals)
Measurement category:	CAT III
Rated voltage (versus earth):	Power supply V1: 110...230V AC / 130...230V DC $\pm 15\%$: 265 V AC Power supply V2: 24...48V DC $\pm 15\%$: 55 V DC Power supply V3: 110...200V AC / 110...200V DC $\pm 15\%$: 265 V AC Relay: 250 V AC (CAT III) I/O's: 30 V DC
Test voltages:	Test time 60s, acc. IEC/EN 61010-1 (2011) <ul style="list-style-type: none">• power supply versus inputs U ¹⁾: 3600V AC• power supply versus inputs I: 3000V AC• power supply V1, V3 versus bus, I/O's: 3000V AC• power supply V2 versus bus, I/O's: 880V DC• inputs U versus inputs I: 1800V AC• inputs U versus bus, I/O's ¹⁾: 3600V AC• inputs I versus bus, I/O's: 3000V AC• inputs I versus inputs I: 1500V AC

¹⁾ During type test only, with all protective impedances removed



The device uses the principle of protective impedance for the voltage inputs to ensure protection against electric shock. All circuits of the device are tested during final inspection.

Prior to performing high voltage or isolation tests involving the voltage inputs, all output connections of SINEAX DM5S or DM5F, especially analog outputs, Modbus and USB interface, must be removed. A possible high-voltage test between input and output circuits must be limited to 500V DC, otherwise electronic components can be damaged.

Applied regulations, standards and directives

IEC/EN 61 010-1	Safety regulations for electrical measuring, control and laboratory equipment
IEC/EN 60 688	Electrical measuring transducers for converting AC electrical variables into analog or digital signals
DIN 40 110	AC quantities
IEC/EN 60 068-2-1/ -2/-3/-6/-27:	Ambient tests -1 Cold, -2 Dry heat, -3 Damp heat, -6 Vibration, -27 Shock
IEC/EN 60 529	Protection type by case
IEC/EN 61 000-6-2/ 61 000-6-4:	Electromagnetic compatibility (EMC) Generic standard for industrial environment
IEC/EN 61 131-2	Programmable controllers - equipment, requirements and tests (digital inputs/outputs 12/24V DC)
IEC/EN 61 326	Electrical equipment for measurement, control and laboratory use - EMC requirements
IEC/EN 62 053-31	Pulse output devices for electromechanical and electronic meters (S0 output)
UL94	Tests for flammability of plastic materials for parts in devices and appliances
2002/95/EG (RoHS)	EC directive on the restriction of the use of certain hazardous substances

Warning

This is a class A product. In a domestic environment this product may cause radio interference in which case the user may be required to take adequate measures.

This device complies with part 15 of the FCC:

Operation is subject to the following two conditions: (1) This device may not cause harmful interference, and (2) this device must accept any interference received, including interference that may cause undesired operation.

This Class A digital apparatus complies with Canadian ICES-0003.

10. Dimensional drawings

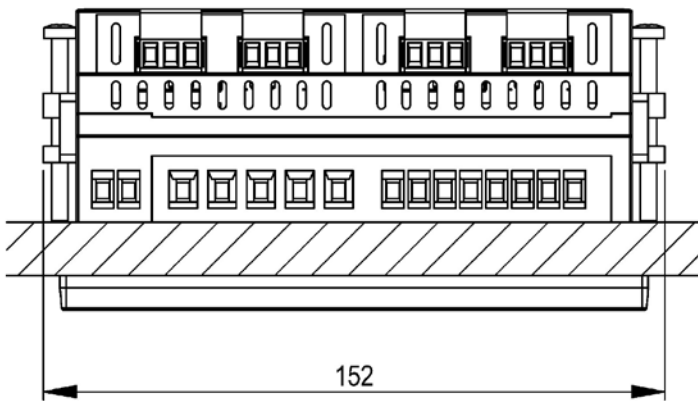
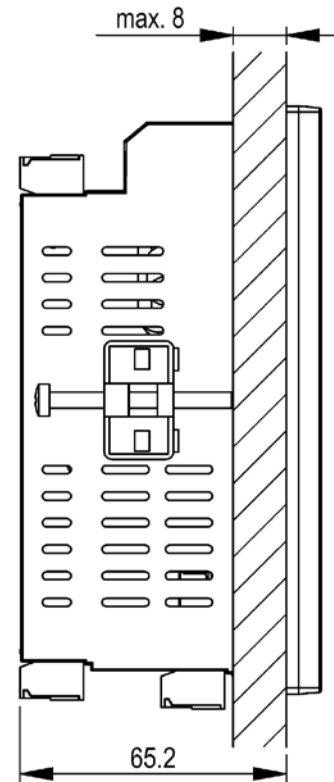
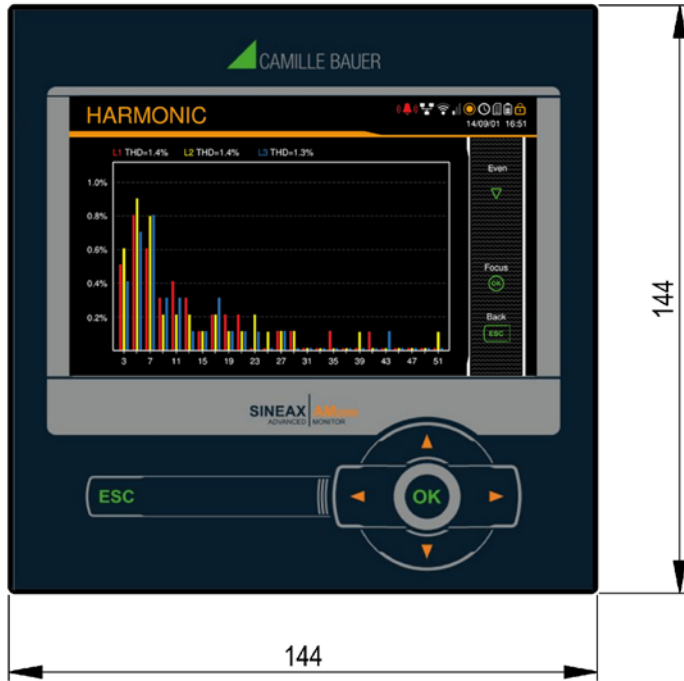

Annex

A Description of measured quantities

Used abbreviations

1L	Single phase system
2L	Split phase; system with 2 phases and centre tap
3Lb	3-wire system with balanced load
3Lu	3-wire system with unbalanced load
3Lu.A	3-wire system with unbalanced load, Aron connection (only 2 currents connected)
4Lb	4-wire system with balanced load
4Lu	4-wire system with unbalanced load
4Lu.O	4-wire system with unbalanced load, Open-Y (reduced voltage connection)

A1 Basic measurements

The basic measured quantities are calculated each 200ms by determining an average over 10 cycles at 50Hz resp. 12 cycles at 60Hz. If a measurement is available depends on the selected system.

Depending on the measured quantity also minimum and maximum values are determined and non-volatile stored with timestamp. These values may be reset by the user via display, see [resetting of measurements](#).

Measurement	present	max	min	1L	2L	3Lb	3Lu	3Lu.A	4Lb	4Lu.O	4Lu
Voltage U	•	•	•	√	√				√		
Voltage U_{1N}	•	•	•		√					√	√
Voltage U_{2N}	•	•	•		√					√	√
Voltage U_{3N}	•	•	•							√	√
Voltage U_{12}	•	•	•			√	√	√		√	√
Voltage U_{23}	•	•	•			√	√	√		√	√
Voltage U_{31}	•	•	•			√	√	√		√	√
Zero displacement voltage U_{NE}	•	•									√
Current I	•	•		√		√			√		
Current I1	•	•			√		√	√		√	√
Current I2	•	•			√		√	√		√	√
Current I3	•	•					√	√		√	√
Neutral current I_N (calculated)	•	•								√	√
Active power P	•	•		√	√	√	√	√	√	√	√
Active power P1	•	•			√					√	√
Active power P2	•	•			√					√	√
Active power P3	•	•								√	√
Total reactive power Q	•	•		√	√	√	√	√	√	√	√
Total reactive power Q1	•	•			√					√	√
Total reactive power Q2	•	•			√					√	√
Total reactive power Q3	•	•								√	√
Distortion reactive power D	•	•		√	√	√	√	√	√	√	√
Distortion reactive power D1	•	•			√					√	√
Distortion reactive power D2	•	•			√					√	√
Distortion reactive power D3	•	•								√	√
Fundamental reactive power Q(H1)	•	•		√	√	√	√	√	√	√	√
Fundamental reactive power Q1(H1)	•	•			√					√	√
Fundamental reactive power Q2(H1)	•	•			√					√	√
Fundamental reactive power Q3(H1)	•	•								√	√

Measurement	present	max	min	1L	2L	3Lb	3Lu	3Lu.A	4Lb	4Lu.O	4Lu
Apparent power S	•	•		√	√	√	√	√	√	√	√
Apparent power S1	•	•			√					√	√
Apparent power S2	•	•			√					√	√
Apparent power S3	•	•								√	√
Frequency F	•	•	•	√	√	√	√	√	√	√	√
Power factor PF	•			√	√	√	√	√	√	√	√
Power factor PF1	•				√					√	√
Power factor PF2	•				√					√	√
Power factor PF3	•									√	√
PF incoming inductive			•	√	√	√	√	√	√	√	√
PF incoming capacitive			•	√	√	√	√	√	√	√	√
PF outgoing inductive			•	√	√	√	√	√	√	√	√
PF outgoing capacitive			•	√	√	√	√	√	√	√	√
Reactive power factor QF	•			√	√	√	√	√	√	√	√
Reactive power factor QF1	•				√					√	√
Reactive power factor QF2	•				√					√	√
Reactive power factor QF3	•									√	√
Load factor LF	•			√	√	√	√	√	√	√	√
Load factor LF1	•				√					√	√
Load factor LF2	•				√					√	√
Load factor LF3	•									√	√
cosφ (H1)	•			√	√	√	√	√	√	√	√
cosφ L1 (H1)	•				√					√	√
cosφ L2 (H1)	•				√					√	√
cosφ L3 (H1)	•									√	√
cosφ (H1), incoming inductive			•	√	√	√	√	√	√	√	√
cosφ (H1), incoming capacitive			•	√	√	√	√	√	√	√	√
cosφ (H1), outgoing inductive			•	√	√	√	√	√	√	√	√
cosφ (H1), outgoing capacitive			•	√	√	√	√	√	√	√	√
tanφ (H1)	•			√	√	√	√	√	√	√	√
tanφ L1 (H1)	•				√					√	√
tanφ L2 (H1)	•				√					√	√
tanφ L3 (H1)	•									√	√
$U_{mean}=(U1N+U2N)/2$	•				√						
$U_{mean}=(U1N+U2N+U3N)/3$	•										√
$U_{mean}=(U12+U23+U31)/3$	•					√	√	√			
$I_{mean}=(I1+I2)/2$	•				√						
$I_{mean}=(I1+I2+I3)/3$	•						√			√	√
IMS, Average current with sign of P	•			√	√	√	√	√	√	√	√
Phase angle between U1 and U2	•					√	√	√		√	√
Phase angle between U2 and U3	•					√	√	√		√	√
Phase angle between U3 and U1	•					√	√	√		√	√
Angle between U and I	•			√		√	√	√	√		
Angle between U1 and I1	•				√					√	√
Angle between U2 and I2	•				√					√	√
Angle between U3 and I3	•									√	√
Maximum ΔU <> Um ¹⁾	•	•			√	√	√	√			√
Maximum ΔI <> Im ²⁾	•	•			√		√			√	√

¹⁾ maximum deviation from the mean value of all voltages (see A3)

²⁾ maximum deviation from the mean value of all currents (see A3)

√ Available via Modbus/RTU communication interface only

Reactive power

Most of the loads consume a combination of ohmic and inductive current from the power system. Reactive power arises by means of the inductive load. But the number of non-linear loads, such as RPM regulated drives, rectifiers, thyristor controlled systems or fluorescent lamps, is increasing. They cause non-sinusoidal AC currents, which may be represented as a sum of harmonics. Thus the reactive power to transmit increases and leads to higher transmission losses and higher energy costs. This part of the reactive power is called distortion reactive power.

Normally reactive power is unwanted, because there is no usable active component in it. Because the transmission of reactive power over long distances is uneconomic, it makes sense to install compensation systems close to the consumers. So transmission capacities may be used better and losses and voltage drops by means of harmonic currents can be avoided.

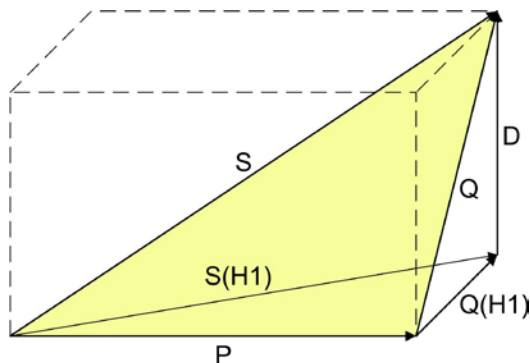

- P: Active power
- S: Apparent power including harmonic components
- S1: Fundamental apparent power
- Q: Total reactive power
- Q(H1): Fundamental reactive power
- D: Distortion reactive power

The reactive power may be divided in a fundamental and a distortion component. Only the fundamental reactive power may be compensated directly by means of the classical capacitive method. The distortion components have to be combated using inductors or active harmonic conditioners.

The **load factor PF** is the relation between active power P and apparent power S, including all possibly existing harmonic parts. This factor is often called $\cos\varphi$, which is only partly correct. The PF corresponds to the **cos φ** only, if there is no harmonic content present in the system. So the **cos φ** represents the relation between the active power P and the fundamental apparent power S(H1).

The **tan φ** is often used as a target quantity for the capacitive reactive power compensation. It corresponds to the relation of the fundamental reactive power Q(H1) and the active power P.

Power factors

The **power factor PF** gives the relation between active and apparent power. If there are no harmonics present in the system, it corresponds to the $\cos\varphi$. The PF has a range of $-1 \dots 0 \dots +1$, where the sign gives the direction of energy flow.

The **load factor LF** is a quantity derived from the PF, which allows making a statement about the load type. Only this way it's possible to measure a range like 0.5 capacitive ... 1 ... 0.5 inductive in a non-ambiguous way.

The **reactive power factor QF** gives the relation between reactive and apparent power.

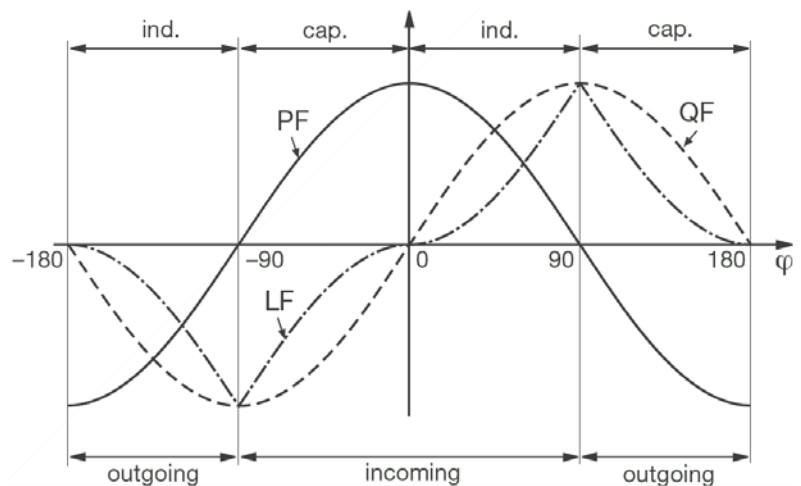

Zero displacement voltage U_{NE}

Starting from the generating system with star point E (which is normally earthed), the star point (N) on load side is shifted in case of unbalanced load. The zero displacement voltage between E and N may be determined by a vectorial addition of the voltage vectors of the three phases:

$$\underline{U}_{NE} = - (\underline{U}_{1N} + \underline{U}_{2N} + \underline{U}_{3N}) / 3$$

A displacement voltage may also occur due to harmonics of order 3, 9, 15, 21 etc., because the dedicated currents add in the neutral wire.

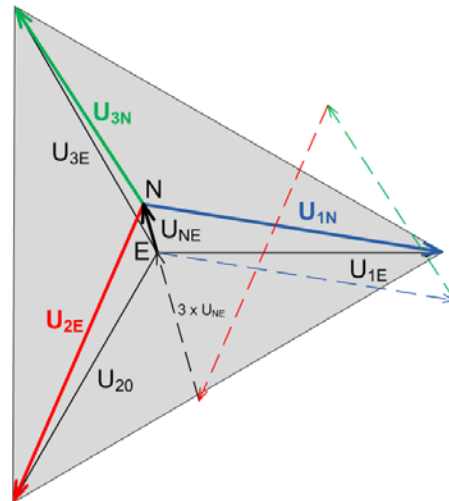

Earth fault monitoring in IT systems

Via the determination of the zero displacement voltage it's possible to detect a first earth fault in an unearthed IT system. To do so, the device is configured for measurement in a 4-wire system with unbalanced load and the neutral connector is connected to earth. In case of a single phase earth fault there is a resulting zero displacement voltage of $U_{LL} / \sqrt{3}$. The alarming may be done e.g. by means of a relay output.

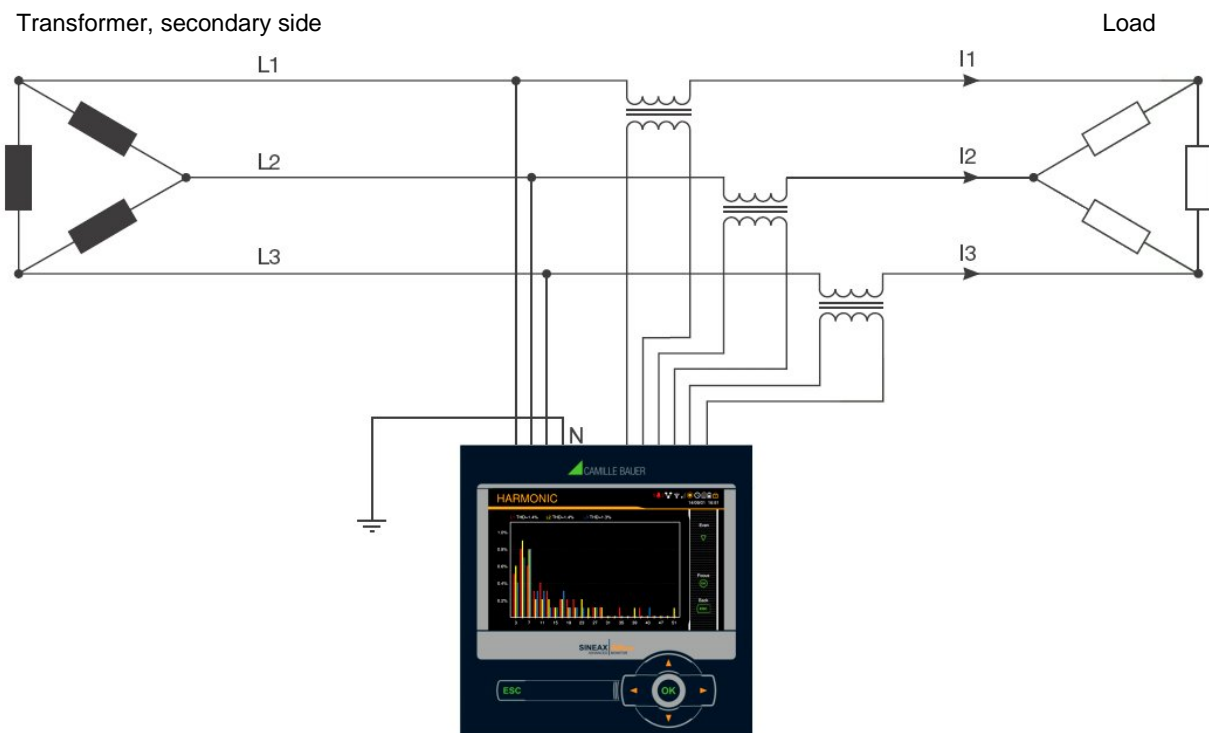

Because in case of a fault the voltage triangle formed by the three phases does not change, the voltage and current measurements as well as the system power values will still be measured and displayed correctly. Also the meters carry on to work as expected.

The method is suited to detect a fault condition during normal operation. A declination of the isolation resistance may not be detected this way. This should be measured during a periodical control of the system using a mobile system.

Another possibility to analyze fault conditions in a grid offers the method of the [symmetrical components](#) as described in A3.

A2 Harmonic analysis

The harmonic analysis is performed according IEC 61000-4-7 over 10 cycles at 50Hz resp. 12 cycles at 60Hz. If a measured quantity is available depends on the selected system.

Measurement	present	max	1L	2L	3Lb	3Lu	3Lu.A	4Lb	4Lu.O	4Lu
THD Voltage U1N/U	●	●	√	√				√	√	√
THD Voltage U2N	●	●	√	√					√	√
THD Voltage U3N	●	●							√	√
THD Voltage U12	●	●			√	√	√			
THD Voltage U23	●	●			√	√	√			
THD Voltage U31	●	●			√	√	√			
THD Current I1/I	●	●	√	√	√	√	√	√	√	√
THD Current I2	●	●	√	√	√	√	√	√	√	√
THD Current I3	●	●	√	√	√	√	√	√	√	√
TDD Current I1/I	●	●	√	√	√	√	√	√	√	√
TDD Current I2	●	●	√		√	√			√	√
TDD Current I3	●	●			√	√			√	√
Harmonic contents 2 nd ...50 th U1N/U	●	●	√	√				√	√	√
Harmonic contents 2 nd ...50 th U2N	●	●	√						√	√
Harmonic contents 2 nd ...50 th U3N	●	●							√	√
Harmonic contents 2 nd ...50 th U12	●	●			√	√	√			
Harmonic contents 2 nd ...50 th U23	●	●			√	√	√			
Harmonic contents 2 nd ...50 th U31	●	●			√	√	√			
Harmonic contents 2 nd ...50 th I1/I	●	●	√	√	√	√	√	√	√	√
Harmonic contents 2 nd ...50 th I2	●	●	√		√	√			√	√
Harmonic contents 2 nd ...50 th I3	●	●			√	√			√	√

√ Available via Modbus/RTU communication interface only

Harmonics

Harmonics are multiples of the fundamental resp. system frequency. They arise if non-linear loads, such as RPM regulated drives, rectifiers, thyristor controlled systems or fluorescent lamps are present in the power system. Thus undesired side effects occur, such as additional thermal stress to operational resources or electrical mains, which lead to an advanced aging or even damage. Also the reliability of sensitive loads can be affected and unexplainable disturbances may occur. In industrial networks the image of the harmonics gives good information about the kind of loads connected. See also:

► [Increase of reactive power due to harmonic currents](#)

TDD (Total Demand Distortion)

The complete harmonic content of the currents is calculated additionally as Total Demand Distortion, briefly TDD. This value is scaled to the rated current resp. rated power. Only this way it's possible to estimate the influence of the current harmonics on the connected equipment correctly.

Maximum values

The maximum values of the harmonic analysis arise from the monitoring of THD and TDD. The maximum values of individual harmonics are not monitored separately, but are stored if a maximum value of THD or TDD is detected. The image of the maximum harmonics therefore always corresponds to the dedicated THD resp. TDD.



The accuracy of the harmonic analysis strongly depends on the quality of the current and voltage transformers possibly used. In the harmonics range transformers normally change both, the amplitude and the phase of the signals to measure. It's valid: The higher the frequency of the harmonic, the higher its damping resp. phase shift.

A3 System imbalance

Measured quantity	present	max	min	1L	2L	3Lb	3Lu	3Lu.A	4Lb	4Lu.O	4Lu
UR1: Positive sequence [V]	•					√	√	√			√
UR2: Negative sequence [V]	•					√	√	√			√
U0: Zero sequence [V]	•										√
U: Imbalance UR2/UR1	•	•				√	√	√			√
U: Imbalance U0/UR1	•	•									√
IR1: Positive sequence [A]	•						√			√	√
IR2: Negative sequence [A]	•						√			√	√
I0: Zero sequence [A]	•									√	√
I: Imbalance IR2/IR1	•	•					√			√	√
I: Imbalance I0/IR1	•	•								√	√

Imbalance in three-phase systems may occur due to single-phase loads, but also due to failures, such as e.g. the blowing of a fuse, an earth fault, a phase failure or an isolation defect. Also harmonics of the 3rd, 9th, 15th, 21st etc. order, which add in the neutral wire, may lead to imbalance. Operating resources dimensioned to rated values, such as three-phase generators, transformers or motors on load side, may be excessively stressed by imbalance. So a shorter life cycle, a damage or failure due to thermal stress can result. Therefore monitoring imbalance helps to reduce the costs for maintenance and extends the undisturbed operating time of the used resources.

Imbalance or unbalanced load relays use different measurement principles. One of them is the approach of the symmetrical components, the other one calculates the maximum deviation from the mean-value of the three phase values. The results of these methods are not equal and don't have the same intention. Both of these principles are implemented in the device.

Symmetrical components (acc. Fortescue)

The imbalance calculation method by means of the symmetrical components is ambitious and intensive to calculate. The results may be used for disturbance analysis and for protection purposes in three-phase systems. The real existing system is divided in symmetrical system parts: A positive sequence, a negative sequence and (for systems with neutral conductor) a zero sequence system. The approach is easiest to understand for rotating machines. The positive sequence represents a positive rotating field, the negative sequence a negative (braking) rotating field with opposite sense of direction. Therefore the negative sequence prevents that the machine can generate the full turning moment. For e.g. generators the maximum permissible current imbalance is typically limited to a value of 8...12%.

Maximum deviation from the mean value

The calculation of the maximum deviation from the mean value of the phase currents resp. phase voltages gives the information if a grid or substation is imbalanced loaded. The results are independent of rated values and the present load situation. So a more symmetrical system can be aspired, e.g. by changing loads from one phase to another.

Also failure detection is possible. The capacitors used in compensation systems are wear parts, which fail quite often and then have to be replaced. When using three phase power capacitors all phases will be compensated equally which leads to almost identical currents flowing through the capacitors, if the system load is comparable. By monitoring the current imbalance it's then possible to estimate if a capacitor failure is present.

The maximum deviations are calculated in the same steps as the instantaneous values and therefore are arranged there ([see A1](#)).

A4 Mean values and trend

Measured quantity	Present	Trend	max	min	History
Active power incoming 1s...60min. ¹⁾	•	•	•	•	5
Active power outgoing 1s...60min. ¹⁾	•	•	•	•	5
Reactive power incoming 1s...60min. ¹⁾	•	•	•	•	5
Reactive power outgoing 1s...60min. ¹⁾	•	•	•	•	5
Apparent power 1s...60min. ¹⁾	•	•	•	•	5
Mean value quantity 1 1s...60min. ²⁾	•	•	•	•	1
....					
Mean value quantity 12 1s...60min. ²⁾	•	•	•	•	1

¹⁾ Interval time t1 ²⁾ Interval time t2

The device calculates automatically the mean values of all system power quantities. In addition up to 12 further mean value quantities can be freely selected.

Calculating the mean-values

The mean value calculation is performed via integration of the measured instantaneous values over a configurable averaging interval. The interval time may be selected in the range from one second up to one hour. Possible interim values are set the way that a multiple of it is equal to a minute or an hour. Mean values of power quantities (interval time t1) and free quantities (interval time t2) may have different averaging intervals.

Synchronization

For the synchronization of the averaging intervals the internal clock or an external signal via digital input may be used. In case of an external synchronization the interval should be within the given range of one second up to one hour. The synchronization is important for making e.g. the mean value of power quantities on generating and demand side comparable.

Trend

The estimated final value (trend) of mean values is determined by weighted addition of measurements of the past and the present interval. It serves for early detection of a possible exceeding of a given maximum value. This can then be avoided, e.g. by switching off an active load.

History

For mean values of system powers the last 5 interval values may be displayed on the device or read via interface. For configurable quantities the value of the last interval is provided via communication interface.

Bimetal current

This measured quantity serves for measuring the long-term effect of the current, e.g. for monitoring the warming of a current-carrying line. To do so, an exponential function is used, similar to the charging curve of a capacitor. The response time of the bimetal function can be freely selected, but normally it corresponds to the interval for determining the power mean-values.

Measured quantity	Present	max	min	1L	2L	3Lb	3Lu	3Lu.A	4Lb	4Lu.O	4Lu
Bimetal current IB, 1...60min. ³⁾	•	•		√		√			√		
Bimetal current IB1, 1...60min. ³⁾	•	•			√		√	√		√	√
Bimetal current IB2, 1...60min. ³⁾	•	•			√		√	√		√	√
Bimetal current IB3, 1...60min. ³⁾	•	•					√	√		√	√

³⁾ Interval time t3

A5 Meters

Measured quantity	1L	2L	3Lb	3Lu	3Lu.A	4Lb	4Lu.O	4Lu
Active energy incoming, high tariff	•	•	•	•	•	•	•	•
Active energy outgoing, high tariff	•	•	•	•	•	•	•	•
Reactive energy incoming, high tariff	•	•	•	•	•	•	•	•
Reactive energy outgoing, high tariff	•	•	•	•	•	•	•	•
Active energy incoming, low tariff	•	•	•	•	•	•	•	•
Active energy outgoing, low tariff	•	•	•	•	•	•	•	•
Reactive energy incoming, low tariff	•	•	•	•	•	•	•	•
Reactive energy outgoing, low tariff	•	•	•	•	•	•	•	•
User configured meter 1	Only basic quantities can be selected which are supported in the present system.							
User configured meter 2								
User configured meter 3								
User configured meter 4								
User configured meter 5								
User configured meter 6								
User configured meter 7								
User configured meter 8								
User configured meter 9								
User configured meter 10								
User configured meter 11								
User configured meter 12								

Standard meters

The meters for active and reactive energy of the system are always active.

User configured meters

To each of these meters the user can freely assign a basic quantity and a tariff. For application with short measurement time, e.g. energy consumption of a working day or shift, the resolution can be adapted.

B Display matrices

B0 Used abbreviations for the measurements

Instantaneous values















Name	Measurement identification	Unit	Description
U	U TRMS	V	Voltage system
U1N	U 1N TRMS	V	Voltage between phase L1 and neutral
U2N	U 2N TRMS	V	Voltage between phase L2 and neutral
U3N	U 3N TRMS	V	Voltage between phase L3 and neutral
U12	U 12 TRMS	V	Voltage between phases L1 and L2
U23	U 23 TRMS	V	Voltage between phases L2 and L3
U31	U 31 TRMS	V	Voltage between phases L3 and L1
UNE	U NE TRMS	V	Zero displacement voltage 4-wire systems
I	I TRMS	A	Current system
I1	I 1 TRMS	A	Current phase L1
I2	I 2 TRMS	A	Current phase L2
I3	I 3 TRMS	A	Current phase L3
IN	I N TRMS	A	Neutral current
P	P TRMS	W	Active power system ($P=P1+P2+P3$)
P1	P 1 TRMS	W	Active power phase L1
P2	P 2 TRMS	W	Active power phase L2
P3	P 3 TRMS	W	Active power phase L3
Q	Q TRMS	var	Reactive power system ($Q=Q1+Q2+Q3$)
Q1	Q 1 TRMS	var	Reactive power phase L1
Q2	Q 2 TRMS	var	Reactive power phase L2
Q3	Q 3 TRMS	var	Reactive power phase L3
S	S TRMS	VA	Apparent power system
S1	S 1 TRMS	VA	Apparent power phase L1
S2	S 2 TRMS	VA	Apparent power phase L2
S3	S 3 TRMS	VA	Apparent power phase L3
F	F TRMS	Hz	System frequency
PF	PF TRMS		Active power factor P/S
PF1	PF 1 TRMS		Active power factor P1/S1
PF2	PF 2 TRMS		Active power factor P2/S2
PF3	PF 3 TRMS		Active power factor P3/S3
QF	QF TRMS		Reactive power factor Q / S
QF1	QF 1 TRMS		Reactive power factor Q1 / S1
QF2	QF 2 TRMS		Reactive power factor Q2 / S2
QF3	QF 3 TRMS		Reactive power factor Q3 / S3
LF	LF TRMS		Load factor system
LF1	LF 1 TRMS		Load factor phase L1
LF2	LF 2 TRMS		Load factor phase L2
LF3	LF 3 TRMS		Load factor phase L3
UR1	U pos SEQ	V	Positive sequence voltage
UR2	U neg SEQ	V	Negative sequence voltage
U0	U zero SEQ	V	Zero sequence voltage
IR1	I pos SEQ	A	Positive sequence current
IR2	I neg SEQ	A	Negative sequence current
I0	I zero SEQ	A	Zero sequence current
UR2R1	U neg/pos UNB	%	Unbalance factor voltage UR2/UR1
IR2R1	I neg/pos UNB	%	Unbalance factor current IR2/IR1
U0R1	U zero/pos UNB	%	Unbalance factor voltage U0/UR1
I0R1	I zero/pos UNB	%	Unbalance factor current I0/IR1

Minimum and maximum of instantaneous values









Name	Measurement identification	Unit	Description
U_MM	U TRMS ▲ TS ▼ TS	V	Minimum and maximum value of U
U1N_MM	U 1N TRMS ▲ TS ▼ TS	V	Minimum and maximum value of U1N
U2N_MM	U 2N TRMS ▲ TS ▼ TS	V	Minimum and maximum value of U2N
U3N_MM	U 3N TRMS ▲ TS ▼ TS	V	Minimum and maximum value of U3N
U12_MM	U 12 TRMS ▲ TS ▼ TS	V	Minimum and maximum value of U12
U23_MM	U 23 TRMS ▲ TS ▼ TS	V	Minimum and maximum value of U23
U31_MM	U 31 TRMS ▲ TS ▼ TS	V	Minimum and maximum value of U31
I_MAX	I TRMS ▲ TS	A	Maximum value of I
I1_MAX	I 1 TRMS ▲ TS	A	Maximum value of I1
I2_MAX	I 2 TRMS ▲ TS	A	Maximum value of I2
I3_MAX	I 3 TRMS ▲ TS	A	Maximum value of I3
IN_MAX	I N TRMS ▲ TS	A	Maximum value of IN
P_MAX	P TRMS ▲ TS	W	Maximum value of P
P1_MAX	P 1 TRMS ▲ TS	W	Maximum value of P1
P2_MAX	P 2 TRMS ▲ TS	W	Maximum value of P2
P3_MAX	P 3 TRMS ▲ TS	W	Maximum value of P3
Q_MAX	Q TRMS ▲ TS	var	Maximum value of Q
Q1_MAX	Q 1 TRMS ▲ TS	var	Maximum value of Q1
Q2_MAX	Q 2 TRMS ▲ TS	var	Maximum value of Q2
Q3_MAX	Q 3 TRMS ▲ TS	var	Maximum value of Q3
S_MAX	S TRMS ▲ TS	VA	Maximum value of S
S1_MAX	S 1 TRMS ▲ TS	VA	Maximum value of S1
S2_MAX	S 2 TRMS ▲ TS	VA	Maximum value of S2
S3_MAX	S 3 TRMS ▲ TS	VA	Maximum value of S3
F_MM	F TRMS ▲ TS	Hz	Minimum and maximum value of F
UR21_MAX	U neg/pos UNB ▲ TS	%	Maximum value of UR2/UR1
IR21_MAX	I neg/pos UNB ▲ TS	%	Maximum value of IR2/IR1
THD_U_MAX	U THD ▲ TS	%	Max. Total Harmonic Distortion of U
THD_U1N_MAX	U 1N THD ▲ TS	%	Max. Total Harmonic Distortion of U1N
THD_U2N_MAX	U 2N THD ▲ TS	%	Max. Total Harmonic Distortion of U2N
THD_U3N_MAX	U 3N THD ▲ TS	%	Max. Total Harmonic Distortion of U3N
THD_U12_MAX	U 12 THD ▲ TS	%	Max. Total Harmonic Distortion of U12
THD_U23_MAX	U 23 THD ▲ TS	%	Max. Total Harmonic Distortion of U23
THD_U31_MAX	U 31 THD ▲ TS	%	Max. Total Harmonic Distortion of U31
TDD_I_MAX	I TDD ▲ TS	%	Max. Total Demand Distortion of I
TDD_I1_MAX	I 1 TDD ▲ TS	%	Max. Total Demand Distortion of I1
TDD_I2_MAX	I 2 TDD ▲ TS	%	Max. Total Demand Distortion of I2
TDD_I3_MAX	I 3 TDD ▲ TS	%	Max. Total Demand Distortion of I3

TS: Timestamp of occurrence, e.g. 2014/09/17 11:12:03









Mean-values, trend and bimetal current

Name	Measurement identification	Unit	Description
M1	(m) (p) (q)  (t2)	(mu)	Mean-value 1
M2	(m) (p) (q)  (t2)	(mu)	Mean-value 2
...	(m) (p) (q)  (t2)	(mu)	...
M11	(m) (p) (q)  (t2)	(mu)	Mean-value 11
M12	(m) (p) (q)  (t2)	(mu)	Mean-value 12
TR_M1	(m) (p) (q)  (t2)	(mu)	Trend mean-value 1
TR_M2	(m) (p) (q)  (t2)	(mu)	Trend mean-value 2
...	(m) (p) (q)  (t2)	(mu)	...
TR_M11	(m) (p) (q)  (t2)	(mu)	Trend mean-value 11
TR_M12	(m) (p) (q)  (t2)	(mu)	Trend mean-value 12
IB	IB  (t3)	A	Bimetal current, system
IB1	IB 1  (t3)	A	Bimetal current, phase L1
IB2	IB 2  (t3)	A	Bimetal current, phase L2
IB3	IB 3  (t3)	A	Bimetal current, phase L3

Minimum and maximum of mean-values and bimetal-current

Name	Measurement identification	Unit	Description
M1_MM	(m) (p) (q)  (t2) ▲ TS ▼ TS	..	Min/Max mean-value 1
M2_MM	(m) (p) (q)  (t2) ▲ TS ▼ TS	..	Min/Max mean-value 2
...	(m) (p) (q)  (t2) ▲ TS ▼ TS
M11_MM	(m) (p) (q)  (t2) ▲ TS ▼ TS	..	Min/Max mean-value 11
M12_MM	(m) (p) (q)  (t2) ▲ TS ▼ TS	..	Min/Max mean-value 12
IB_MAX	IB  (t3) ▲ TS	A	Maximum bimetal current, system
IB1_MAX	IB 1  (t3) ▲ TS	A	Maximum Bimetal current, phase L1
IB2_MAX	IB 2  (t3) ▲ TS	A	Maximum Bimetal current, phase L2
IB3_MAX	IB 3  (t3) ▲ TS	A	Maximum Bimetal current, phase L3



Meters

Name	Measurement identification	Unit	Description
ΣPIN_HT	P  ΣHT	Wh	Meter P incoming high tariff
ΣPOUT_HT	P  ΣHT	Wh	Meter P outgoing high tariff
ΣQIN_HT	Q  ΣHT	varh	Meter Q incoming high tariff
ΣQOUT_HT	Q  ΣHT	varh	Meter Q outgoing high tariff
ΣPIN_NT	P  ΣLT	Wh	Meter P incoming low tariff
ΣPOUT_NT	P  ΣLT	Wh	Meter P outgoing low tariff
ΣQIN_NT	Q  ΣLT	varh	Meter Q incoming low tariff
ΣQOUT_NT	Q  ΣLT	varh	Meter Q outgoing low tariff
ΣMETER1	(m) (p) (q) Σ(T)	(mu)	User meter 1, Tarif HT oder NT
ΣMETER2	(m) (p) (q) Σ(T)	(mu)	User meter 2, Tarif HT oder NT
.....	(m) (p) (q) Σ(T)	(mu)
ΣMETER11	(m) (p) (q) Σ(T)	(mu)	User meter 11, Tarif HT oder NT
ΣMETER12	(m) (p) (q) Σ(T)	(mu)	User meter 12, Tarif HT oder NT





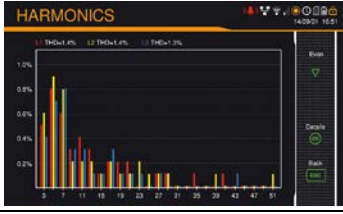
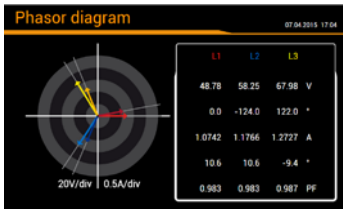

(m): Short description of basic quantity, e.g. „P“
 (p): Phase reference of the selected quantity, e.g. „1“
 (q): Quadrant information, e.g. „“ (outgoing)

(t2), (t3): Averaging interval, e.g. „5s“, or „15min“
 (T): Associated tariff, e.g. „HT“ or „LT“
 (mu): Unit of basic quantity







Graphical measurement displays

Name	Presentation	Description
Px_TRIANGLE		Graphic of the power triangle consisting of: <ul style="list-style-type: none"> Active, reactive and apparent power P_x, Q_x, S_x Distortion reactive power D_x Fundamental reactive power $Q_x(H1)$ $\cos(\varphi)$ of fundamental Active power factor PF_x
PF_MIN		Graphic: Minimum active power factor PF in all 4 quadrants
Cφ_MIN	(as PF_MIN)	Graphic: Minimum $\cos(\varphi)$ in all 4 quadrants
MT_S		Graphic mean-value S: Trend, last 5 interval values, minimum and maximum
MT_PIN	(as MT_S)	Graphic mean-value P incoming: Trend, last 5 interval values, minimum and maximum
MT_POUT	(as MT_S)	Graphic mean-value P outgoing: Trend, last 5 interval values, minimum and maximum
MT_QIN	(as MT_S)	Graphic mean-value Q incoming: Trend, last 5 interval values, minimum and maximum
MT_QOUT	(as MT_S)	Graphic mean-value Q outgoing: Trend, last 5 interval values, minimum and maximum
HO_UX		Graphic: Odd harmonics 3 rd up to 49 th + Total Harmonic Distortion of all voltages
HO_IX	(as HO_UX)	Graphic: Odd harmonics 3 rd up to 49 th + Total Harmonic Distortion of all currents
HE_UX	(as HO_UX)	Graphic: Even harmonics 2 nd up to 50 th + Total Harmonic Distortion of all voltages
HE_IX	(as HO_UX)	Graphic: Even harmonics 2 nd up to 50 th + Total Harmonic Distortion of all currents
HO_UX_MAX	(as HO_UX)	Graphic: Maximum values odd harmonics 3 rd up to 49 th + Total Harmonic Distortion of all voltages
HO_IX_MAX	(as HO_UX)	Graphic: Maximum values odd harmonics 3 rd up to 49 th + Total Harmonic Distortion of all currents
HE_UX_MAX	(as HO_UX)	Graphic: Maximum values even harmonics 2 nd up to 50 th + Total Harmonic Distortion of all voltages
HE_IX_MAX	(as HO_UX)	Graphic: Maximum values even harmonics 2 nd up to 50 th + Total Harmonic Distortion of all currents
PHASOR		Graphic: All current and voltage phasors with present load situation







B1 Display matrices for single phase system

Display menu	Corresponding matrix																								
 Instantaneous values	<table border="1"> <tr> <td>U</td> <td>U_MM</td> </tr> <tr> <td>I</td> <td>I_MAX</td> </tr> <tr> <td>P</td> <td>P_MAX</td> </tr> <tr> <td>F</td> <td>F_MM</td> </tr> <tr> <td>P</td> <td>P_MAX</td> </tr> <tr> <td>Q</td> <td>Q_MAX</td> </tr> <tr> <td>S</td> <td>S_MAX</td> </tr> <tr> <td>PF</td> <td></td> </tr> <tr> <td>P_TRIANGLE</td> <td></td> </tr> <tr> <td>PF_MIN</td> <td>Cφ_MIN</td> </tr> </table>	U	U_MM	I	I_MAX	P	P_MAX	F	F_MM	P	P_MAX	Q	Q_MAX	S	S_MAX	PF		P_TRIANGLE		PF_MIN	Cφ_MIN				
U	U_MM																								
I	I_MAX																								
P	P_MAX																								
F	F_MM																								
P	P_MAX																								
Q	Q_MAX																								
S	S_MAX																								
PF																									
P_TRIANGLE																									
PF_MIN	Cφ_MIN																								
 Energy consumption Meter contents Standard meters	<table border="1"> <tr> <td>ΣPIN_HT</td> </tr> <tr> <td>ΣPIN_LT</td> </tr> <tr> <td>ΣQIN_HT</td> </tr> <tr> <td>ΣQIN_LT</td> </tr> <tr> <td>ΣPOUT_HT</td> </tr> <tr> <td>ΣPOUT_LT</td> </tr> <tr> <td>ΣQOUT_HT</td> </tr> <tr> <td>ΣQOUT_LT</td> </tr> </table>	ΣPIN_HT	ΣPIN_LT	ΣQIN_HT	ΣQIN_LT	ΣPOUT_HT	ΣPOUT_LT	ΣQOUT_HT	ΣQOUT_LT																
ΣPIN_HT																									
ΣPIN_LT																									
ΣQIN_HT																									
ΣQIN_LT																									
ΣPOUT_HT																									
ΣPOUT_LT																									
ΣQOUT_HT																									
ΣQOUT_LT																									
 Energy consumption Meter contents User meters	<table border="1"> <tr> <td>ΣMETER1</td> </tr> <tr> <td>ΣMETER2</td> </tr> <tr> <td>ΣMETER3</td> </tr> <tr> <td>ΣMETER4</td> </tr> <tr> <td>ΣMETER5</td> </tr> <tr> <td>ΣMETER6</td> </tr> <tr> <td>ΣMETER7</td> </tr> <tr> <td>ΣMETER8</td> </tr> <tr> <td>ΣMETER9</td> </tr> <tr> <td>ΣMETER10</td> </tr> <tr> <td>ΣMETER11</td> </tr> <tr> <td>ΣMETER12</td> </tr> </table>	ΣMETER1	ΣMETER2	ΣMETER3	ΣMETER4	ΣMETER5	ΣMETER6	ΣMETER7	ΣMETER8	ΣMETER9	ΣMETER10	ΣMETER11	ΣMETER12												
ΣMETER1																									
ΣMETER2																									
ΣMETER3																									
ΣMETER4																									
ΣMETER5																									
ΣMETER6																									
ΣMETER7																									
ΣMETER8																									
ΣMETER9																									
ΣMETER10																									
ΣMETER11																									
ΣMETER12																									
 Energy consumption Mean-values Power mean-values + trend	<table border="1"> <tr> <td>MT_PIN</td> <td>MT_POUT</td> <td>MT_QIN</td> <td>MT_QOUT</td> <td>MT_S</td> </tr> </table>	MT_PIN	MT_POUT	MT_QIN	MT_QOUT	MT_S																			
MT_PIN	MT_POUT	MT_QIN	MT_QOUT	MT_S																					
 Energy consumption Mean-values User mean-values + trend	<table border="1"> <tr> <td>TR_M1 / M1</td> <td>TR_M5 / M5</td> <td>TR_M9 / M9</td> <td>M1_MM</td> <td>M1_MM</td> <td>M1_MM</td> </tr> <tr> <td>TR_M2 / M2</td> <td>TR_M6 / M6</td> <td>TR_M10 / M10</td> <td>M2_MM</td> <td>M2_MM</td> <td>M2_MM</td> </tr> <tr> <td>TR_M3 / M3</td> <td>TR_M7 / M7</td> <td>TR_M11 / M11</td> <td>M3_MM</td> <td>M3_MM</td> <td>M3_MM</td> </tr> <tr> <td>TR_M4 / M4</td> <td>TR_M8 / M8</td> <td>TR_M12 / M12</td> <td>M4_MM</td> <td>M4_MM</td> <td>M4_MM</td> </tr> </table>	TR_M1 / M1	TR_M5 / M5	TR_M9 / M9	M1_MM	M1_MM	M1_MM	TR_M2 / M2	TR_M6 / M6	TR_M10 / M10	M2_MM	M2_MM	M2_MM	TR_M3 / M3	TR_M7 / M7	TR_M11 / M11	M3_MM	M3_MM	M3_MM	TR_M4 / M4	TR_M8 / M8	TR_M12 / M12	M4_MM	M4_MM	M4_MM
TR_M1 / M1	TR_M5 / M5	TR_M9 / M9	M1_MM	M1_MM	M1_MM																				
TR_M2 / M2	TR_M6 / M6	TR_M10 / M10	M2_MM	M2_MM	M2_MM																				
TR_M3 / M3	TR_M7 / M7	TR_M11 / M11	M3_MM	M3_MM	M3_MM																				
TR_M4 / M4	TR_M8 / M8	TR_M12 / M12	M4_MM	M4_MM	M4_MM																				
 Energy consumption Bimetal current	<table border="1"> <tr> <td>IB</td> </tr> <tr> <td>IB_MAX</td> </tr> </table>	IB	IB_MAX																						
IB																									
IB_MAX																									





B2 Display matrices for split-phase (two-phase) systems

Display menu	Corresponding matrix																								
 Instantaneous values	<table border="1"> <tr> <td>U1N U2N U F</td> <td>U1N_MM U2N_MM U_MM F_MM</td> <td></td> </tr> <tr> <td>I1 I2 I1_MAX I2_MAX</td> <td></td> <td></td> </tr> <tr> <td>P Q S PF</td> <td>P1 P2 Q1 Q2</td> <td>P_MAX / P1_MAX Q_MAX / P2_MAX S_MAX / Q1_MAX - / Q2_MAX</td> </tr> <tr> <td>P_TRIANGLE</td> <td>P1_TRIANGLE</td> <td>P2_TRIANGLE</td> </tr> <tr> <td>PF_MIN</td> <td>Cφ_MIN</td> <td></td> </tr> </table>	U1N U2N U F	U1N_MM U2N_MM U_MM F_MM		I1 I2 I1_MAX I2_MAX			P Q S PF	P1 P2 Q1 Q2	P_MAX / P1_MAX Q_MAX / P2_MAX S_MAX / Q1_MAX - / Q2_MAX	P_TRIANGLE	P1_TRIANGLE	P2_TRIANGLE	PF_MIN	Cφ_MIN										
U1N U2N U F	U1N_MM U2N_MM U_MM F_MM																								
I1 I2 I1_MAX I2_MAX																									
P Q S PF	P1 P2 Q1 Q2	P_MAX / P1_MAX Q_MAX / P2_MAX S_MAX / Q1_MAX - / Q2_MAX																							
P_TRIANGLE	P1_TRIANGLE	P2_TRIANGLE																							
PF_MIN	Cφ_MIN																								
 Energy consumption Meter contents Standard meters	<table border="1"> <tr> <td>ΣPIN_HT ΣPIN_LT ΣQIN_HT ΣQIN_LT ΣPOUT_HT ΣPOUT_LT ΣQOUT_HT ΣQOUT_LT</td> </tr> </table>	ΣPIN_HT ΣPIN_LT ΣQIN_HT ΣQIN_LT ΣPOUT_HT ΣPOUT_LT ΣQOUT_HT ΣQOUT_LT																							
ΣPIN_HT ΣPIN_LT ΣQIN_HT ΣQIN_LT ΣPOUT_HT ΣPOUT_LT ΣQOUT_HT ΣQOUT_LT																									
 Energy consumption Meter contents User meters	<table border="1"> <tr> <td>ΣMETER1 ΣMETER2 ΣMETER3 ΣMETER4 ΣMETER5 ΣMETER6 ΣMETER7 ΣMETER8 ΣMETER9 ΣMETER10 ΣMETER11 ΣMETER12</td> </tr> </table>	ΣMETER1 ΣMETER2 ΣMETER3 ΣMETER4 ΣMETER5 ΣMETER6 ΣMETER7 ΣMETER8 ΣMETER9 ΣMETER10 ΣMETER11 ΣMETER12																							
ΣMETER1 ΣMETER2 ΣMETER3 ΣMETER4 ΣMETER5 ΣMETER6 ΣMETER7 ΣMETER8 ΣMETER9 ΣMETER10 ΣMETER11 ΣMETER12																									
 Energy consumption Mean-values Power mean-values + trend	<table border="1"> <tr> <td>MT_PIN</td> <td>MT_POUT</td> <td>MT_QIN</td> <td>MT_QOUT</td> <td>MT_S</td> </tr> </table>	MT_PIN	MT_POUT	MT_QIN	MT_QOUT	MT_S																			
MT_PIN	MT_POUT	MT_QIN	MT_QOUT	MT_S																					
 Energy consumption Mean-values User mean-values + trend	<table border="1"> <tr> <td>TR_M1 / M1</td> <td>TR_M5 / M5</td> <td>TR_M9 / M9</td> <td>M1_MM</td> <td>M1_MM</td> <td>M1_MM</td> </tr> <tr> <td>TR_M2 / M2</td> <td>TR_M6 / M6</td> <td>TR_M10 / M10</td> <td>M2_MM</td> <td>M2_MM</td> <td>M2_MM</td> </tr> <tr> <td>TR_M3 / M3</td> <td>TR_M7 / M7</td> <td>TR_M11 / M11</td> <td>M3_MM</td> <td>M3_MM</td> <td>M3_MM</td> </tr> <tr> <td>TR_M4 / M4</td> <td>TR_M8 / M8</td> <td>TR_M12 / M12</td> <td>M4_MM</td> <td>M4_MM</td> <td>M4_MM</td> </tr> </table>	TR_M1 / M1	TR_M5 / M5	TR_M9 / M9	M1_MM	M1_MM	M1_MM	TR_M2 / M2	TR_M6 / M6	TR_M10 / M10	M2_MM	M2_MM	M2_MM	TR_M3 / M3	TR_M7 / M7	TR_M11 / M11	M3_MM	M3_MM	M3_MM	TR_M4 / M4	TR_M8 / M8	TR_M12 / M12	M4_MM	M4_MM	M4_MM
TR_M1 / M1	TR_M5 / M5	TR_M9 / M9	M1_MM	M1_MM	M1_MM																				
TR_M2 / M2	TR_M6 / M6	TR_M10 / M10	M2_MM	M2_MM	M2_MM																				
TR_M3 / M3	TR_M7 / M7	TR_M11 / M11	M3_MM	M3_MM	M3_MM																				
TR_M4 / M4	TR_M8 / M8	TR_M12 / M12	M4_MM	M4_MM	M4_MM																				
 Energy consumption Bimetal current	<table border="1"> <tr> <td>IB1 IB2 IB1_MAX IB2_MAX</td> </tr> </table>	IB1 IB2 IB1_MAX IB2_MAX																							
IB1 IB2 IB1_MAX IB2_MAX																									







B3 Display matrices for 3-wire system, balanced load

Display menu	Corresponding matrix																								
 Instantaneous values	<table border="1"> <tr> <td>U12 U23 U31 F</td> <td>U12_MM U23_MM U31_MM F_MM</td> <td>UR1 UR2 UR2R1 UR21_MAX</td> </tr> <tr> <td>I I_MAX</td> <td></td> <td></td> </tr> <tr> <td>P Q S PF</td> <td>P_MAX Q_MAX S_MAX</td> <td></td> </tr> <tr> <td>P_TRIANGLE</td> <td></td> <td></td> </tr> <tr> <td>PF_MIN</td> <td>Cp_MIN</td> <td></td> </tr> </table>	U12 U23 U31 F	U12_MM U23_MM U31_MM F_MM	UR1 UR2 UR2R1 UR21_MAX	I I_MAX			P Q S PF	P_MAX Q_MAX S_MAX		P_TRIANGLE			PF_MIN	Cp_MIN										
U12 U23 U31 F	U12_MM U23_MM U31_MM F_MM	UR1 UR2 UR2R1 UR21_MAX																							
I I_MAX																									
P Q S PF	P_MAX Q_MAX S_MAX																								
P_TRIANGLE																									
PF_MIN	Cp_MIN																								
 Energy consumption Meter contents Standard meters	<table border="1"> <tr> <td> ΣPIN_HT ΣPIN_LT ΣQIN_HT ΣQIN_LT ΣPOUT_HT ΣPOUT_LT ΣQOUT_HT ΣQOUT_LT </td> </tr> </table>	Σ PIN_HT Σ PIN_LT Σ QIN_HT Σ QIN_LT Σ POUT_HT Σ POUT_LT Σ QOUT_HT Σ QOUT_LT																							
Σ PIN_HT Σ PIN_LT Σ QIN_HT Σ QIN_LT Σ POUT_HT Σ POUT_LT Σ QOUT_HT Σ QOUT_LT																									
 Energy consumption Meter contents User meters	<table border="1"> <tr> <td> ΣMETER1 ΣMETER2 ΣMETER3 ΣMETER4 ΣMETER5 ΣMETER6 ΣMETER7 ΣMETER8 ΣMETER9 ΣMETER10 ΣMETER11 ΣMETER12 </td> </tr> </table>	Σ METER1 Σ METER2 Σ METER3 Σ METER4 Σ METER5 Σ METER6 Σ METER7 Σ METER8 Σ METER9 Σ METER10 Σ METER11 Σ METER12																							
Σ METER1 Σ METER2 Σ METER3 Σ METER4 Σ METER5 Σ METER6 Σ METER7 Σ METER8 Σ METER9 Σ METER10 Σ METER11 Σ METER12																									
 Energy consumption Mean-values Power mean-values + trend	<table border="1"> <tr> <td>MT_PIN</td> <td>MT_POUT</td> <td>MT_QIN</td> <td>MT_QOUT</td> <td>MT_S</td> </tr> </table>	MT_PIN	MT_POUT	MT_QIN	MT_QOUT	MT_S																			
MT_PIN	MT_POUT	MT_QIN	MT_QOUT	MT_S																					
 Energy consumption Mean-values User mean-values + trend	<table border="1"> <tr> <td>TR_M1 / M1</td> <td>TR_M5 / M5</td> <td>TR_M9 / M9</td> <td>M1_MM</td> <td>M1_MM</td> <td>M1_MM</td> </tr> <tr> <td>TR_M2 / M2</td> <td>TR_M6 / M6</td> <td>TR_M10 / M10</td> <td>M2_MM</td> <td>M2_MM</td> <td>M2_MM</td> </tr> <tr> <td>TR_M3 / M3</td> <td>TR_M7 / M7</td> <td>TR_M11 / M11</td> <td>M3_MM</td> <td>M3_MM</td> <td>M3_MM</td> </tr> <tr> <td>TR_M4 / M4</td> <td>TR_M8 / M8</td> <td>TR_M12 / M12</td> <td>M4_MM</td> <td>M4_MM</td> <td>M4_MM</td> </tr> </table>	TR_M1 / M1	TR_M5 / M5	TR_M9 / M9	M1_MM	M1_MM	M1_MM	TR_M2 / M2	TR_M6 / M6	TR_M10 / M10	M2_MM	M2_MM	M2_MM	TR_M3 / M3	TR_M7 / M7	TR_M11 / M11	M3_MM	M3_MM	M3_MM	TR_M4 / M4	TR_M8 / M8	TR_M12 / M12	M4_MM	M4_MM	M4_MM
TR_M1 / M1	TR_M5 / M5	TR_M9 / M9	M1_MM	M1_MM	M1_MM																				
TR_M2 / M2	TR_M6 / M6	TR_M10 / M10	M2_MM	M2_MM	M2_MM																				
TR_M3 / M3	TR_M7 / M7	TR_M11 / M11	M3_MM	M3_MM	M3_MM																				
TR_M4 / M4	TR_M8 / M8	TR_M12 / M12	M4_MM	M4_MM	M4_MM																				
 Energy consumption Bimetal current	<table border="1"> <tr> <td>IB IB_MAX</td> </tr> </table>	IB IB_MAX																							
IB IB_MAX																									







B4 Display matrices for 3-wire systems, unbalanced load

Display menu	Corresponding matrix																								
 Instantaneous values	<table border="1"> <tr> <td>U12 U23 U31 F</td> <td>U12_MM U23_MM U31_MM F_MM</td> <td>UR1 UR2 UR2R1 UR21_MAX</td> </tr> <tr> <td>I1 I2 I3</td> <td>I1_MAX I2_MAX I3_MAX</td> <td>IR1 IR2 IR2R1 IR21_MAX</td> </tr> <tr> <td>P Q S PF</td> <td>P_MAX Q_MAX S_MAX</td> <td></td> </tr> <tr> <td>P_TRIANGLE</td> <td></td> <td></td> </tr> <tr> <td>PF_MIN</td> <td>Cp_MIN</td> <td></td> </tr> </table>	U12 U23 U31 F	U12_MM U23_MM U31_MM F_MM	UR1 UR2 UR2R1 UR21_MAX	I1 I2 I3	I1_MAX I2_MAX I3_MAX	IR1 IR2 IR2R1 IR21_MAX	P Q S PF	P_MAX Q_MAX S_MAX		P_TRIANGLE			PF_MIN	Cp_MIN										
U12 U23 U31 F	U12_MM U23_MM U31_MM F_MM	UR1 UR2 UR2R1 UR21_MAX																							
I1 I2 I3	I1_MAX I2_MAX I3_MAX	IR1 IR2 IR2R1 IR21_MAX																							
P Q S PF	P_MAX Q_MAX S_MAX																								
P_TRIANGLE																									
PF_MIN	Cp_MIN																								
 Energy consumption Meter contents Standard meters	<table border="1"> <tr> <td> ΣPIN_HT ΣPIN_LT ΣQIN_HT ΣQIN_LT ΣPOUT_HT ΣPOUT_LT ΣQOUT_HT ΣQOUT_LT </td> </tr> </table>	Σ PIN_HT Σ PIN_LT Σ QIN_HT Σ QIN_LT Σ POUT_HT Σ POUT_LT Σ QOUT_HT Σ QOUT_LT																							
Σ PIN_HT Σ PIN_LT Σ QIN_HT Σ QIN_LT Σ POUT_HT Σ POUT_LT Σ QOUT_HT Σ QOUT_LT																									
 Energy consumption Meter contents User meters	<table border="1"> <tr> <td> ΣMETER1 ΣMETER2 ΣMETER3 ΣMETER4 ΣMETER5 ΣMETER6 ΣMETER7 ΣMETER8 ΣMETER9 ΣMETER10 ΣMETER11 ΣMETER12 </td> </tr> </table>	Σ METER1 Σ METER2 Σ METER3 Σ METER4 Σ METER5 Σ METER6 Σ METER7 Σ METER8 Σ METER9 Σ METER10 Σ METER11 Σ METER12																							
Σ METER1 Σ METER2 Σ METER3 Σ METER4 Σ METER5 Σ METER6 Σ METER7 Σ METER8 Σ METER9 Σ METER10 Σ METER11 Σ METER12																									
 Energy consumption Mean-values Power mean-values + trend	<table border="1"> <tr> <td>MT_PIN</td> <td>MT_POUT</td> <td>MT_QIN</td> <td>MT_QOUT</td> <td>MT_S</td> </tr> </table>	MT_PIN	MT_POUT	MT_QIN	MT_QOUT	MT_S																			
MT_PIN	MT_POUT	MT_QIN	MT_QOUT	MT_S																					
 Energy consumption Mean-values User mean-values + trend	<table border="1"> <tr> <td>TR_M1 / M1</td> <td>TR_M5 / M5</td> <td>TR_M9 / M9</td> <td>M1_MM</td> <td>M1_MM</td> <td>M1_MM</td> </tr> <tr> <td>TR_M2 / M2</td> <td>TR_M6 / M6</td> <td>TR_M10 / M10</td> <td>M2_MM</td> <td>M2_MM</td> <td>M2_MM</td> </tr> <tr> <td>TR_M3 / M3</td> <td>TR_M7 / M7</td> <td>TR_M11 / M11</td> <td>M3_MM</td> <td>M3_MM</td> <td>M3_MM</td> </tr> <tr> <td>TR_M4 / M4</td> <td>TR_M8 / M8</td> <td>TR_M12 / M12</td> <td>M4_MM</td> <td>M4_MM</td> <td>M4_MM</td> </tr> </table>	TR_M1 / M1	TR_M5 / M5	TR_M9 / M9	M1_MM	M1_MM	M1_MM	TR_M2 / M2	TR_M6 / M6	TR_M10 / M10	M2_MM	M2_MM	M2_MM	TR_M3 / M3	TR_M7 / M7	TR_M11 / M11	M3_MM	M3_MM	M3_MM	TR_M4 / M4	TR_M8 / M8	TR_M12 / M12	M4_MM	M4_MM	M4_MM
TR_M1 / M1	TR_M5 / M5	TR_M9 / M9	M1_MM	M1_MM	M1_MM																				
TR_M2 / M2	TR_M6 / M6	TR_M10 / M10	M2_MM	M2_MM	M2_MM																				
TR_M3 / M3	TR_M7 / M7	TR_M11 / M11	M3_MM	M3_MM	M3_MM																				
TR_M4 / M4	TR_M8 / M8	TR_M12 / M12	M4_MM	M4_MM	M4_MM																				
 Energy consumption Bimetal current	<table border="1"> <tr> <td>IB1 IB2 IB3</td> <td>IB1_MAX IB2_MAX IB3_MAX</td> </tr> </table>	IB1 IB2 IB3	IB1_MAX IB2_MAX IB3_MAX																						
IB1 IB2 IB3	IB1_MAX IB2_MAX IB3_MAX																								







B5 Display matrices for 3-wire systems, unbalanced load, Aron

Display menu	Corresponding matrix																								
 Instantaneous values	<table border="1"> <tr> <td>U12 U23 U31 F</td> <td>U12_MM U23_MM U31_MM F_MM</td> <td>UR1 UR2 UR2R1 UR21_MAX</td> </tr> <tr> <td>I1 I2 I3</td> <td>I1_MAX I2_MAX I3_MAX</td> <td>IR1 IR2 IR2R1 IR21_MAX</td> </tr> <tr> <td>P Q S PF</td> <td>P_MAX Q_MAX S_MAX</td> <td></td> </tr> <tr> <td>P_TRIANGLE</td> <td></td> <td></td> </tr> <tr> <td>PF_MIN</td> <td>Cp_MIN</td> <td></td> </tr> </table>	U12 U23 U31 F	U12_MM U23_MM U31_MM F_MM	UR1 UR2 UR2R1 UR21_MAX	I1 I2 I3	I1_MAX I2_MAX I3_MAX	IR1 IR2 IR2R1 IR21_MAX	P Q S PF	P_MAX Q_MAX S_MAX		P_TRIANGLE			PF_MIN	Cp_MIN										
U12 U23 U31 F	U12_MM U23_MM U31_MM F_MM	UR1 UR2 UR2R1 UR21_MAX																							
I1 I2 I3	I1_MAX I2_MAX I3_MAX	IR1 IR2 IR2R1 IR21_MAX																							
P Q S PF	P_MAX Q_MAX S_MAX																								
P_TRIANGLE																									
PF_MIN	Cp_MIN																								
 Energy consumption Meter contents Standard meters	<table border="1"> <tr> <td> ΣPIN_HT ΣPIN_LT ΣQIN_HT ΣQIN_LT ΣPOUT_HT ΣPOUT_LT ΣQOUT_HT ΣQOUT_LT </td> </tr> </table>	ΣPIN_HT ΣPIN_LT ΣQIN_HT ΣQIN_LT ΣPOUT_HT ΣPOUT_LT ΣQOUT_HT ΣQOUT_LT																							
ΣPIN_HT ΣPIN_LT ΣQIN_HT ΣQIN_LT ΣPOUT_HT ΣPOUT_LT ΣQOUT_HT ΣQOUT_LT																									
 Energy consumption Meter contents User meters	<table border="1"> <tr> <td> ΣMETER1 ΣMETER2 ΣMETER3 ΣMETER4 ΣMETER5 ΣMETER6 ΣMETER7 ΣMETER8 ΣMETER9 ΣMETER10 ΣMETER11 ΣMETER12 </td> </tr> </table>	ΣMETER1 ΣMETER2 ΣMETER3 ΣMETER4 ΣMETER5 ΣMETER6 ΣMETER7 ΣMETER8 ΣMETER9 ΣMETER10 ΣMETER11 ΣMETER12																							
ΣMETER1 ΣMETER2 ΣMETER3 ΣMETER4 ΣMETER5 ΣMETER6 ΣMETER7 ΣMETER8 ΣMETER9 ΣMETER10 ΣMETER11 ΣMETER12																									
 Energy consumption Mean-values Power mean-values + trend	<table border="1"> <tr> <td>MT_PIN</td> <td>MT_POUT</td> <td>MT_QIN</td> <td>MT_QOUT</td> <td>MT_S</td> </tr> </table>	MT_PIN	MT_POUT	MT_QIN	MT_QOUT	MT_S																			
MT_PIN	MT_POUT	MT_QIN	MT_QOUT	MT_S																					
 Energy consumption Mean-values User mean-values + trend	<table border="1"> <tr> <td>TR_M1 / M1</td> <td>TR_M5 / M5</td> <td>TR_M9 / M9</td> <td>M1_MM</td> <td>M1_MM</td> <td>M1_MM</td> </tr> <tr> <td>TR_M2 / M2</td> <td>TR_M6 / M6</td> <td>TR_M10 / M10</td> <td>M2_MM</td> <td>M2_MM</td> <td>M2_MM</td> </tr> <tr> <td>TR_M3 / M3</td> <td>TR_M7 / M7</td> <td>TR_M11 / M11</td> <td>M3_MM</td> <td>M3_MM</td> <td>M3_MM</td> </tr> <tr> <td>TR_M4 / M4</td> <td>TR_M8 / M8</td> <td>TR_M12 / M12</td> <td>M4_MM</td> <td>M4_MM</td> <td>M4_MM</td> </tr> </table>	TR_M1 / M1	TR_M5 / M5	TR_M9 / M9	M1_MM	M1_MM	M1_MM	TR_M2 / M2	TR_M6 / M6	TR_M10 / M10	M2_MM	M2_MM	M2_MM	TR_M3 / M3	TR_M7 / M7	TR_M11 / M11	M3_MM	M3_MM	M3_MM	TR_M4 / M4	TR_M8 / M8	TR_M12 / M12	M4_MM	M4_MM	M4_MM
TR_M1 / M1	TR_M5 / M5	TR_M9 / M9	M1_MM	M1_MM	M1_MM																				
TR_M2 / M2	TR_M6 / M6	TR_M10 / M10	M2_MM	M2_MM	M2_MM																				
TR_M3 / M3	TR_M7 / M7	TR_M11 / M11	M3_MM	M3_MM	M3_MM																				
TR_M4 / M4	TR_M8 / M8	TR_M12 / M12	M4_MM	M4_MM	M4_MM																				
 Energy consumption Bimetal current	<table border="1"> <tr> <td>IB1 IB2 IB3</td> <td>IB1_MAX IB2_MAX IB3_MAX</td> </tr> </table>	IB1 IB2 IB3	IB1_MAX IB2_MAX IB3_MAX																						
IB1 IB2 IB3	IB1_MAX IB2_MAX IB3_MAX																								







B6 Display matrices for 4-wire system, balanced load

Display menu	Corresponding matrix																								
<div style="border: 1px solid green; padding: 5px; margin-bottom: 10px;">  Instantaneous values </div>	<table border="1" style="width: 100%; border-collapse: collapse;"> <tr> <td style="width: 50%; padding: 5px;">U I P F</td> <td style="width: 50%; padding: 5px;">U_MM I_MAX P_MAX F_MM</td> </tr> <tr> <td style="padding: 5px;">P Q S PF</td> <td style="padding: 5px;">P_MAX Q_MAX S_MAX</td> </tr> <tr> <td style="padding: 5px;">P_TRIANGLE</td> <td></td> </tr> <tr> <td style="padding: 5px;">PF_MIN</td> <td style="padding: 5px;">Cφ_MIN</td> </tr> </table>	U I P F	U_MM I_MAX P_MAX F_MM	P Q S PF	P_MAX Q_MAX S_MAX	P_TRIANGLE		PF_MIN	Cφ_MIN																
U I P F	U_MM I_MAX P_MAX F_MM																								
P Q S PF	P_MAX Q_MAX S_MAX																								
P_TRIANGLE																									
PF_MIN	Cφ_MIN																								
<div style="border: 1px solid green; padding: 5px; margin-bottom: 5px;">  Energy consumption </div> <div style="border: 1px solid green; padding: 5px; margin-bottom: 5px; margin-left: 20px;"> Meter contents </div> <div style="border: 1px solid green; padding: 5px; margin-left: 40px;"> Standard meters </div>	<table border="1" style="width: 100%; border-collapse: collapse;"> <tr> <td style="padding: 5px;"> ΣPIN_HT ΣPIN_LT ΣQIN_HT ΣQIN_LT ΣPOUT_HT ΣPOUT_LT ΣQOUT_HT ΣQOUT_LT </td> </tr> </table>	ΣPIN_HT ΣPIN_LT ΣQIN_HT ΣQIN_LT ΣPOUT_HT ΣPOUT_LT ΣQOUT_HT ΣQOUT_LT																							
ΣPIN_HT ΣPIN_LT ΣQIN_HT ΣQIN_LT ΣPOUT_HT ΣPOUT_LT ΣQOUT_HT ΣQOUT_LT																									
<div style="border: 1px solid green; padding: 5px; margin-bottom: 5px;">  Energy consumption </div> <div style="border: 1px solid green; padding: 5px; margin-left: 20px; margin-bottom: 5px;"> Meter contents </div> <div style="border: 1px solid green; padding: 5px; margin-left: 40px;"> User meters </div>	<table border="1" style="width: 100%; border-collapse: collapse;"> <tr> <td style="padding: 5px;"> ΣMETER1 ΣMETER2 ΣMETER3 ΣMETER4 ΣMETER5 ΣMETER6 ΣMETER7 ΣMETER8 ΣMETER9 ΣMETER10 ΣMETER11 ΣMETER12 </td> </tr> </table>	ΣMETER1 ΣMETER2 ΣMETER3 ΣMETER4 ΣMETER5 ΣMETER6 ΣMETER7 ΣMETER8 ΣMETER9 ΣMETER10 ΣMETER11 ΣMETER12																							
ΣMETER1 ΣMETER2 ΣMETER3 ΣMETER4 ΣMETER5 ΣMETER6 ΣMETER7 ΣMETER8 ΣMETER9 ΣMETER10 ΣMETER11 ΣMETER12																									
<div style="border: 1px solid green; padding: 5px; margin-bottom: 5px;">  Energy consumption </div> <div style="border: 1px solid green; padding: 5px; margin-left: 20px; margin-bottom: 5px;"> Mean-values </div> <div style="border: 1px solid green; padding: 5px; margin-left: 40px;"> Power mean-values + trend </div>	<table border="1" style="width: 100%; border-collapse: collapse;"> <tr> <td style="width: 20%; padding: 5px;">MT_PIN</td> <td style="width: 20%; padding: 5px;">MT_POUT</td> <td style="width: 20%; padding: 5px;">MT_QIN</td> <td style="width: 20%; padding: 5px;">MT_QOUT</td> <td style="width: 20%; padding: 5px;">MT_S</td> </tr> </table>	MT_PIN	MT_POUT	MT_QIN	MT_QOUT	MT_S																			
MT_PIN	MT_POUT	MT_QIN	MT_QOUT	MT_S																					
<div style="border: 1px solid green; padding: 5px; margin-bottom: 5px;">  Energy consumption </div> <div style="border: 1px solid green; padding: 5px; margin-left: 20px; margin-bottom: 5px;"> Mean-values </div> <div style="border: 1px solid green; padding: 5px; margin-left: 40px;"> User mean-values + trend </div>	<table border="1" style="width: 100%; border-collapse: collapse;"> <tr> <td style="padding: 5px;">TR_M1 / M1</td> <td style="padding: 5px;">TR_M5 / M5</td> <td style="padding: 5px;">TR_M9 / M9</td> <td style="padding: 5px;">M1_MM</td> <td style="padding: 5px;">M1_MM</td> <td style="padding: 5px;">M1_MM</td> </tr> <tr> <td style="padding: 5px;">TR_M2 / M2</td> <td style="padding: 5px;">TR_M6 / M6</td> <td style="padding: 5px;">TR_M10 / M10</td> <td style="padding: 5px;">M2_MM</td> <td style="padding: 5px;">M2_MM</td> <td style="padding: 5px;">M2_MM</td> </tr> <tr> <td style="padding: 5px;">TR_M3 / M3</td> <td style="padding: 5px;">TR_M7 / M7</td> <td style="padding: 5px;">TR_M11 / M11</td> <td style="padding: 5px;">M3_MM</td> <td style="padding: 5px;">M3_MM</td> <td style="padding: 5px;">M3_MM</td> </tr> <tr> <td style="padding: 5px;">TR_M4 / M4</td> <td style="padding: 5px;">TR_M8 / M8</td> <td style="padding: 5px;">TR_M12 / M12</td> <td style="padding: 5px;">M4_MM</td> <td style="padding: 5px;">M4_MM</td> <td style="padding: 5px;">M4_MM</td> </tr> </table>	TR_M1 / M1	TR_M5 / M5	TR_M9 / M9	M1_MM	M1_MM	M1_MM	TR_M2 / M2	TR_M6 / M6	TR_M10 / M10	M2_MM	M2_MM	M2_MM	TR_M3 / M3	TR_M7 / M7	TR_M11 / M11	M3_MM	M3_MM	M3_MM	TR_M4 / M4	TR_M8 / M8	TR_M12 / M12	M4_MM	M4_MM	M4_MM
TR_M1 / M1	TR_M5 / M5	TR_M9 / M9	M1_MM	M1_MM	M1_MM																				
TR_M2 / M2	TR_M6 / M6	TR_M10 / M10	M2_MM	M2_MM	M2_MM																				
TR_M3 / M3	TR_M7 / M7	TR_M11 / M11	M3_MM	M3_MM	M3_MM																				
TR_M4 / M4	TR_M8 / M8	TR_M12 / M12	M4_MM	M4_MM	M4_MM																				
<div style="border: 1px solid green; padding: 5px; margin-bottom: 5px;">  Energy consumption </div> <div style="border: 1px solid green; padding: 5px; margin-left: 20px;"> Bimetal current </div>	<table border="1" style="width: 100%; border-collapse: collapse;"> <tr> <td style="padding: 5px;"> IB IB_MAX </td> </tr> </table>	IB IB_MAX																							
IB IB_MAX																									

B7 Display matrices for 4-wire systems, unbalanced load

Display menu	Corresponding matrix																				
 Instantaneous values	<table border="1"> <tr> <td>U1N U2N U3N UNE</td> <td>U12 U23 U31 F</td> <td>U1N_MM / U12_MM U2N_MM / U23_MM U3N_MM / U31_MM F_MM / UR2_MM</td> <td>UR1 UR2 U0 UNB_UR2_UR1</td> </tr> <tr> <td>I1 I2 I3 IN</td> <td>I1_MAX I2_MAX I3_MAX IN_MAX</td> <td>IR1 IR2 I0 UNB_IR2_IR1</td> <td></td> </tr> <tr> <td>P Q S PF</td> <td>P1 P2 P3 P</td> <td>Q1 Q2 Q3 Q</td> <td>S1 S2 S3 S P1_MAX P2_MAX P3_MAX P_MAX Q1_MAX Q2_MAX Q3_MAX Q_MAX S1_MAX S2_MAX S3_MAX S_MAX</td> </tr> <tr> <td>P_TRIANGLE</td> <td>P1_TRIANGLE</td> <td>P2_TRIANGLE</td> <td>P3_TRIANGLE</td> </tr> <tr> <td>PF_MIN</td> <td>Cφ_MIN</td> <td></td> <td></td> </tr> </table>	U1N U2N U3N UNE	U12 U23 U31 F	U1N_MM / U12_MM U2N_MM / U23_MM U3N_MM / U31_MM F_MM / UR2_MM	UR1 UR2 U0 UNB_UR2_UR1	I1 I2 I3 IN	I1_MAX I2_MAX I3_MAX IN_MAX	IR1 IR2 I0 UNB_IR2_IR1		P Q S PF	P1 P2 P3 P	Q1 Q2 Q3 Q	S1 S2 S3 S P1_MAX P2_MAX P3_MAX P_MAX Q1_MAX Q2_MAX Q3_MAX Q_MAX S1_MAX S2_MAX S3_MAX S_MAX	P_TRIANGLE	P1_TRIANGLE	P2_TRIANGLE	P3_TRIANGLE	PF_MIN	Cφ_MIN		
U1N U2N U3N UNE	U12 U23 U31 F	U1N_MM / U12_MM U2N_MM / U23_MM U3N_MM / U31_MM F_MM / UR2_MM	UR1 UR2 U0 UNB_UR2_UR1																		
I1 I2 I3 IN	I1_MAX I2_MAX I3_MAX IN_MAX	IR1 IR2 I0 UNB_IR2_IR1																			
P Q S PF	P1 P2 P3 P	Q1 Q2 Q3 Q	S1 S2 S3 S P1_MAX P2_MAX P3_MAX P_MAX Q1_MAX Q2_MAX Q3_MAX Q_MAX S1_MAX S2_MAX S3_MAX S_MAX																		
P_TRIANGLE	P1_TRIANGLE	P2_TRIANGLE	P3_TRIANGLE																		
PF_MIN	Cφ_MIN																				
 Energy consumption Meter contents Standard meters	<table border="1"> <tr> <td>ΣPIN_HT ΣPIN_LT ΣQIN_HT ΣQIN_LT ΣPOUT_HT ΣPOUT_LT ΣQOUT_HT ΣQOUT_LT</td> </tr> </table>	ΣPIN_HT ΣPIN_LT ΣQIN_HT ΣQIN_LT ΣPOUT_HT ΣPOUT_LT ΣQOUT_HT ΣQOUT_LT																			
ΣPIN_HT ΣPIN_LT ΣQIN_HT ΣQIN_LT ΣPOUT_HT ΣPOUT_LT ΣQOUT_HT ΣQOUT_LT																					
 Energy consumption Meter contents User meters	<table border="1"> <tr> <td>ΣMETER1 ΣMETER2 ΣMETER3 ΣMETER4 ΣMETER5 ΣMETER6 ΣMETER7 ΣMETER8 ΣMETER9 ΣMETER10 ΣMETER11 ΣMETER12</td> </tr> </table>	ΣMETER1 ΣMETER2 ΣMETER3 ΣMETER4 ΣMETER5 ΣMETER6 ΣMETER7 ΣMETER8 ΣMETER9 ΣMETER10 ΣMETER11 ΣMETER12																			
ΣMETER1 ΣMETER2 ΣMETER3 ΣMETER4 ΣMETER5 ΣMETER6 ΣMETER7 ΣMETER8 ΣMETER9 ΣMETER10 ΣMETER11 ΣMETER12																					
 Energy consumption Mean-values Power mean-values + trend	<table border="1"> <tr> <td>MT_PIN</td> <td>MT_POUT</td> <td>MT_QIN</td> <td>MT_QOUT</td> <td>MT_S</td> </tr> </table>	MT_PIN	MT_POUT	MT_QIN	MT_QOUT	MT_S															
MT_PIN	MT_POUT	MT_QIN	MT_QOUT	MT_S																	
 Energy consumption Mean-values User mean-values + trend	<table border="1"> <tr> <td>TR_M1 / M1 TR_M2 / M2 TR_M3 / M3 TR_M4 / M4</td> <td>TR_M5 / M5 TR_M6 / M6 TR_M7 / M7 TR_M8 / M8</td> <td>TR_M9 / M9 TR_M10 / M10 TR_M11 / M11 TR_M12 / M12</td> <td>M1_MM M2_MM M3_MM M4_MM</td> <td>M1_MM M2_MM M3_MM M4_MM</td> <td>M1_MM M2_MM M3_MM M4_MM</td> </tr> </table>	TR_M1 / M1 TR_M2 / M2 TR_M3 / M3 TR_M4 / M4	TR_M5 / M5 TR_M6 / M6 TR_M7 / M7 TR_M8 / M8	TR_M9 / M9 TR_M10 / M10 TR_M11 / M11 TR_M12 / M12	M1_MM M2_MM M3_MM M4_MM	M1_MM M2_MM M3_MM M4_MM	M1_MM M2_MM M3_MM M4_MM														
TR_M1 / M1 TR_M2 / M2 TR_M3 / M3 TR_M4 / M4	TR_M5 / M5 TR_M6 / M6 TR_M7 / M7 TR_M8 / M8	TR_M9 / M9 TR_M10 / M10 TR_M11 / M11 TR_M12 / M12	M1_MM M2_MM M3_MM M4_MM	M1_MM M2_MM M3_MM M4_MM	M1_MM M2_MM M3_MM M4_MM																
 Energy consumption Bimetal current	<table border="1"> <tr> <td>IB1 IB2 IB3</td> <td>IB1_MAX IB2_MAX IB3_MAX</td> </tr> </table>	IB1 IB2 IB3	IB1_MAX IB2_MAX IB3_MAX																		
IB1 IB2 IB3	IB1_MAX IB2_MAX IB3_MAX																				

B8 Display matrices for 4-wire system, unbalanced load, Open-Y

Display menu	Corresponding matrix																																																																																										
 Instantaneous values	<table border="1"> <tr> <td>U1N</td> <td>U12</td> <td colspan="4">U1N_MM / U12_MM</td> </tr> <tr> <td>U2N</td> <td>U23</td> <td colspan="4">U2N_MM / U23_MM</td> </tr> <tr> <td>U3N</td> <td>U31</td> <td colspan="4">U3N_MM / U31_MM</td> </tr> <tr> <td>F</td> <td>F</td> <td colspan="4">F_MM / --</td> </tr> <tr> <td>I1</td> <td>I1_MAX</td> <td colspan="4">IR1</td> </tr> <tr> <td>I2</td> <td>I2_MAX</td> <td colspan="4">IR2</td> </tr> <tr> <td>I3</td> <td>I3_MAX</td> <td colspan="4">I0</td> </tr> <tr> <td>IN</td> <td>IN_MAX</td> <td colspan="4">UNB_IR2_IR1</td> </tr> <tr> <td>P</td> <td>P1</td> <td>Q1</td> <td>S1</td> <td>P1_MAX</td> <td>Q1_MAX</td> <td>S1_MAX</td> </tr> <tr> <td>Q</td> <td>P2</td> <td>Q2</td> <td>S2</td> <td>P2_MAX</td> <td>Q2_MAX</td> <td>S2_MAX</td> </tr> <tr> <td>S</td> <td>P3</td> <td>Q3</td> <td>S3</td> <td>P3_MAX</td> <td>Q3_MAX</td> <td>S3_MAX</td> </tr> <tr> <td>PF</td> <td>P</td> <td>Q</td> <td>S</td> <td>P_MAX</td> <td>Q_MAX</td> <td>S_MAX</td> </tr> <tr> <td colspan="2">P_TRIANGLE</td> <td>P1_TRIANGLE</td> <td colspan="2">P2_TRIANGLE</td> <td colspan="2">P3_TRIANGLE</td> </tr> <tr> <td colspan="2">PF_MIN</td> <td colspan="2">Cφ_MIN</td> <td colspan="3"></td> </tr> </table>	U1N	U12	U1N_MM / U12_MM				U2N	U23	U2N_MM / U23_MM				U3N	U31	U3N_MM / U31_MM				F	F	F_MM / --				I1	I1_MAX	IR1				I2	I2_MAX	IR2				I3	I3_MAX	I0				IN	IN_MAX	UNB_IR2_IR1				P	P1	Q1	S1	P1_MAX	Q1_MAX	S1_MAX	Q	P2	Q2	S2	P2_MAX	Q2_MAX	S2_MAX	S	P3	Q3	S3	P3_MAX	Q3_MAX	S3_MAX	PF	P	Q	S	P_MAX	Q_MAX	S_MAX	P_TRIANGLE		P1_TRIANGLE	P2_TRIANGLE		P3_TRIANGLE		PF_MIN		Cφ_MIN				
U1N	U12	U1N_MM / U12_MM																																																																																									
U2N	U23	U2N_MM / U23_MM																																																																																									
U3N	U31	U3N_MM / U31_MM																																																																																									
F	F	F_MM / --																																																																																									
I1	I1_MAX	IR1																																																																																									
I2	I2_MAX	IR2																																																																																									
I3	I3_MAX	I0																																																																																									
IN	IN_MAX	UNB_IR2_IR1																																																																																									
P	P1	Q1	S1	P1_MAX	Q1_MAX	S1_MAX																																																																																					
Q	P2	Q2	S2	P2_MAX	Q2_MAX	S2_MAX																																																																																					
S	P3	Q3	S3	P3_MAX	Q3_MAX	S3_MAX																																																																																					
PF	P	Q	S	P_MAX	Q_MAX	S_MAX																																																																																					
P_TRIANGLE		P1_TRIANGLE	P2_TRIANGLE		P3_TRIANGLE																																																																																						
PF_MIN		Cφ_MIN																																																																																									
 Energy consumption Meter contents Standard meters	<table border="1"> <tr> <td>ΣPIN_HT</td> </tr> <tr> <td>ΣPIN_LT</td> </tr> <tr> <td>ΣQIN_HT</td> </tr> <tr> <td>ΣQIN_LT</td> </tr> <tr> <td>ΣPOUT_HT</td> </tr> <tr> <td>ΣPOUT_LT</td> </tr> <tr> <td>ΣQOUT_HT</td> </tr> <tr> <td>ΣQOUT_LT</td> </tr> </table>	ΣPIN_HT	ΣPIN_LT	ΣQIN_HT	ΣQIN_LT	ΣPOUT_HT	ΣPOUT_LT	ΣQOUT_HT	ΣQOUT_LT																																																																																		
ΣPIN_HT																																																																																											
ΣPIN_LT																																																																																											
ΣQIN_HT																																																																																											
ΣQIN_LT																																																																																											
ΣPOUT_HT																																																																																											
ΣPOUT_LT																																																																																											
ΣQOUT_HT																																																																																											
ΣQOUT_LT																																																																																											
 Energy consumption Meter contents User meters	<table border="1"> <tr> <td>ΣMETER1</td> </tr> <tr> <td>ΣMETER2</td> </tr> <tr> <td>ΣMETER3</td> </tr> <tr> <td>ΣMETER4</td> </tr> <tr> <td>ΣMETER5</td> </tr> <tr> <td>ΣMETER6</td> </tr> <tr> <td>ΣMETER7</td> </tr> <tr> <td>ΣMETER8</td> </tr> <tr> <td>ΣMETER9</td> </tr> <tr> <td>ΣMETER10</td> </tr> <tr> <td>ΣMETER11</td> </tr> <tr> <td>ΣMETER12</td> </tr> </table>	ΣMETER1	ΣMETER2	ΣMETER3	ΣMETER4	ΣMETER5	ΣMETER6	ΣMETER7	ΣMETER8	ΣMETER9	ΣMETER10	ΣMETER11	ΣMETER12																																																																														
ΣMETER1																																																																																											
ΣMETER2																																																																																											
ΣMETER3																																																																																											
ΣMETER4																																																																																											
ΣMETER5																																																																																											
ΣMETER6																																																																																											
ΣMETER7																																																																																											
ΣMETER8																																																																																											
ΣMETER9																																																																																											
ΣMETER10																																																																																											
ΣMETER11																																																																																											
ΣMETER12																																																																																											
 Energy consumption Mean-values Power mean-values + trend	<table border="1"> <tr> <td>MT_PIN</td> <td>MT_POUT</td> <td>MT_QIN</td> <td>MT_QOUT</td> <td>MT_S</td> </tr> </table>	MT_PIN	MT_POUT	MT_QIN	MT_QOUT	MT_S																																																																																					
MT_PIN	MT_POUT	MT_QIN	MT_QOUT	MT_S																																																																																							
 Energy consumption Mean-values User mean-values + trend	<table border="1"> <tr> <td>TR_M1 / M1</td> <td>TR_M5 / M5</td> <td>TR_M9 / M9</td> <td>M1_MM</td> <td>M1_MM</td> <td>M1_MM</td> </tr> <tr> <td>TR_M2 / M2</td> <td>TR_M6 / M6</td> <td>TR_M10 / M10</td> <td>M2_MM</td> <td>M2_MM</td> <td>M2_MM</td> </tr> <tr> <td>TR_M3 / M3</td> <td>TR_M7 / M7</td> <td>TR_M11 / M11</td> <td>M3_MM</td> <td>M3_MM</td> <td>M3_MM</td> </tr> <tr> <td>TR_M4 / M4</td> <td>TR_M8 / M8</td> <td>TR_M12 / M12</td> <td>M4_MM</td> <td>M4_MM</td> <td>M4_MM</td> </tr> </table>	TR_M1 / M1	TR_M5 / M5	TR_M9 / M9	M1_MM	M1_MM	M1_MM	TR_M2 / M2	TR_M6 / M6	TR_M10 / M10	M2_MM	M2_MM	M2_MM	TR_M3 / M3	TR_M7 / M7	TR_M11 / M11	M3_MM	M3_MM	M3_MM	TR_M4 / M4	TR_M8 / M8	TR_M12 / M12	M4_MM	M4_MM	M4_MM																																																																		
TR_M1 / M1	TR_M5 / M5	TR_M9 / M9	M1_MM	M1_MM	M1_MM																																																																																						
TR_M2 / M2	TR_M6 / M6	TR_M10 / M10	M2_MM	M2_MM	M2_MM																																																																																						
TR_M3 / M3	TR_M7 / M7	TR_M11 / M11	M3_MM	M3_MM	M3_MM																																																																																						
TR_M4 / M4	TR_M8 / M8	TR_M12 / M12	M4_MM	M4_MM	M4_MM																																																																																						
 Energy consumption Bimetal current	<table border="1"> <tr> <td>IB1</td> <td>IB1_MAX</td> </tr> <tr> <td>IB2</td> <td>IB2_MAX</td> </tr> <tr> <td>IB3</td> <td>IB3_MAX</td> </tr> </table>	IB1	IB1_MAX	IB2	IB2_MAX	IB3	IB3_MAX																																																																																				
IB1	IB1_MAX																																																																																										
IB2	IB2_MAX																																																																																										
IB3	IB3_MAX																																																																																										

C Logic functions

The principal function of the logical gates is given in the following table, for simplicity shown for gates with two inputs only.

function	symbol	older symbols		truth table	plain text
		ANSI 91-1984	DIN 40700 (alt)		
AND				A B Y	Function is true if all input conditions are fulfilled
				0 0 0	
				0 1 0	
				1 0 0	
				1 1 1	
NAND				A B Y	Function is true if at least one of the input conditions is not fulfilled
				0 0 1	
				0 1 1	
				1 0 1	
				1 1 0	
OR				A B Y	Function is true if at least one of the input conditions is fulfilled
				0 0 0	
				0 1 1	
				1 0 1	
				1 1 1	
NOR				A B Y	Function is true if none of the input conditions is fulfilled
				0 0 1	
				0 1 0	
				1 0 0	
				1 1 0	

Using DIRECT or INVERT the input is directly connected to the output of a monitoring function, without need for a logical combination. Only one input is allowed for these functions.

DIRECT		<table border="1"> <thead> <tr> <th>A</th> <th>Y</th> </tr> </thead> <tbody> <tr> <td>0</td> <td>0</td> </tr> <tr> <td>1</td> <td>1</td> </tr> </tbody> </table>	A	Y	0	0	1	1	The monitoring function is reduced to one input only. The state of the output corresponds to the input.
A	Y								
0	0								
1	1								
INVERT		<table border="1"> <thead> <tr> <th>A</th> <th>Y</th> </tr> </thead> <tbody> <tr> <td>0</td> <td>1</td> </tr> <tr> <td>1</td> <td>0</td> </tr> </tbody> </table>	A	Y	0	1	1	0	The monitoring function is reduced to one input only. The state of the output corresponds to the inverted input.
A	Y								
0	1								
1	0								

D Declaration of conformity

D1 CE conformity



EG - KONFORMITÄTSERKLÄRUNG EC DECLARATION OF CONFORMITY



Dokument-Nr. / Document.No.: AM2000_CE-konf.docx

Hersteller/ Manufacturer: **Camille Bauer Metrawatt AG**
Switzerland

Anschrift / Address: **Aargauerstrasse 7**
CH-5610 Wohlen

Produktbezeichnung/
Product name: **Multifunktionales Leistungsmessgerät mit Netzanalyse**
Multifunctional Power Monitor with System Analysis

Typ / Type: **SINEAX AM2000**

Das bezeichnete Produkt stimmt mit den Vorschriften folgender Europäischer Richtlinien überein, nachgewiesen durch die Einhaltung folgender Normen:

The above mentioned product has been manufactured according to the regulations of the following European directives proven through compliance with the following standards:

Richtlinie / Directive	2004/108/EG(CE) Elektromagnetische Verträglichkeit - EMV-Richtlinie Electromagnetic compatibility - EMC directive	
Norm / Standard	EN 61000-6-2: 2005 Fachgrundnormen - Störfestigkeit für Industriebereiche Generic standards - Immunity for industrial environments	
	EN 61000-6-4: 2007 Fachgrundnormen - Störaussendung für Industriebereiche Generic standards - Emission standard for industrial environments	
Prüfungen / Tests	IEC 61000-4-2 IEC 61000-4-3 IEC 61000-4-4 IEC 61000-4-5 IEC 61000-4-6 IEC 61000-4-8 IEC 61000-4-11	EN 55011

Richtlinie / Directive	2006/95/EG(CE) Elektrische Betriebsmittel zur Verwendung innerhalb bestimmter Spannungsgrenzen – Niederspannungsrichtlinie – CE-Kennzeichnung : 95 Electrical equipment for use within certain voltage limits – Low Voltage Directive – Attachment of CE marking : 95	
Norm / Standard	EN 61010-1: 2010 Sicherheitsbestimmungen für elektrische Mess-, Steuer-, Regel- und Laborgeräte – Teil 1: Allgemeine Anforderungen Safety requirements for electrical equipment for measurement, control and laboratory use – Part 1: General requirements EN 61010-2-30: 2010 Besondere Bestimmungen für Prüf- und Messstromkreise Particular requirements for testing and measuring circuits	

Ort, Datum / Place, date:

Wohlen, 17. April 2015

Unterschrift / signature:

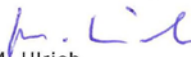
M. Ulrich
Leiter Technik / Head of engineering

J. Brem
Qualitätsmanager / Quality manager

D2 FCC statement

The following statement applies to the products covered in this manual, unless otherwise specified herein. The statement for other products will appear in the accompanying documentation.

NOTE: This equipment has been tested and found to comply with the limits for a Class A digital device, pursuant to Part 15 of the FCC Rules and meets all requirements of the Canadian Interference-Causing Equipment Standard ICES-003 for digital apparatus. These limits are designed to provide reasonable protection against harmful interference in a residential installation. This equipment generates, uses, and can radiate radio frequency energy and, if not installed and used in accordance with the instructions, may cause harmful interference to radio communications. However, there is no guarantee that interference will not occur in a particular installation. If this equipment does cause harmful interference to radio or television reception, which can be determined by turning the equipment off and on, the user is encouraged to try to correct the interference by one or more of the following measures:

- Reorient or relocate the receiving antenna.
- Increase the separation between the equipment and receiver.
- Connect the equipment into an outlet on a circuit different from that to which the receiver is connected.
- Consult the dealer or an experienced radio/T.V. technician for help.

Camille Bauer AG is not responsible for any radio television interference caused by unauthorized modifications of this equipment or the substitution or attachment of connecting cables and equipment other than those specified by Camille Bauer AG. The correction of interference caused by such unauthorized modification, substitution or attachment will be the responsibility of the user.

INDEX

C

Commissioning	22
Configuration menu.....	29

D

Declaration of conformity	60
Demounting.....	7
Device overview.....	6
Dimensional drawing	38
Display matrices.....	47
Driving a counter mechanism	20

E

Electrical connections	
analog outputs	20
Aron connection.....	15
cross sections	9
digital input	19
digital output	20
I/O extensions.....	9
inputs	10
Modbus interface	21
Open-Y	17
power supply	19
relays	19
split phase	18

I

Installation check	23
--------------------------	----

L

Logic components	
AND	59
DIRECT	59
INVERT	59
NAND.....	59
NOR.....	59
OR	59

M

Measured quantities.....	39
Basic measurements	39
Bimetal current.....	45
earth fault monitoring.....	42
harmonic analysis	43
Load factors	41
mean values and trend	45
meters.....	46
system imbalance	44
zero displacement voltage.....	42
Measurement displays	25
Measurements	
reset.....	29
Mechanical mounting	7
Menu operation	24
Mounting	7

O

Operating elements.....	24
-------------------------	----

R

Reactive power	41
Resetting measurements	29

S

Safety notes	6
Scope of supply	5
Service and maintenance	31
Symbols	26
Symmetrical components.....	44

T

Technical data.....	32
---------------------	----

Z

Zero suppression	33
------------------------	----