

**FLUKE®**

# **561 HVACPro**

Infrared Thermometer

**Users Manual**

PN 2562924

February 2006

© 2006 Fluke Corporation, All rights reserved. Printed in USA

All product names are trademarks of their respective companies.

## **LIMITED WARRANTY AND LIMITATION OF LIABILITY**

This Fluke product will be free from defects in material and workmanship for two years from the date of purchase. This warranty does not cover fuses, disposable batteries, or damage from accident, neglect, misuse, alteration, contamination, or abnormal conditions of operation or handling. Resellers are not authorized to extend any other warranty on Fluke's behalf. To obtain service during the warranty period, contact your nearest Fluke authorized service center to obtain return authorization information, then send the product to that Service Center with a description of the problem.

**THIS WARRANTY IS YOUR ONLY REMEDY. NO OTHER WARRANTIES, SUCH AS FITNESS FOR A PARTICULAR PURPOSE, ARE EXPRESSED OR IMPLIED. FLUKE IS NOT LIABLE FOR ANY SPECIAL, INDIRECT, INCIDENTAL OR CONSEQUENTIAL DAMAGES OR LOSSES, ARISING FROM ANY CAUSE OR THEORY.** Since some states or countries do not allow the exclusion or limitation of an implied warranty or of incidental or consequential damages, this limitation of liability may not apply to you.

Fluke Corporation  
P.O. Box 9090  
Everett, WA 98206-9090  
U.S.A.

Fluke Europe B.V.  
P.O. Box 1186  
5602 BD Eindhoven  
The Netherlands

# Table of Contents

Title	Page
Introduction.....	1
Contacting Fluke.....	1
Safety Information.....	2
Features.....	3
Display.....	4
Buttons and Connector.....	5
How the Thermometer Works.....	6
Operating the Thermometer.....	6
Locating a Hot or Cold Spot.....	6
Distance and Spot Size.....	6
Field of View.....	7
Emissivity.....	7
Switching Between °C and °F.....	8
Using the Contact Temperature Probe.....	9
HOLD.....	10
Typical Measurements.....	10
Measuring Heating/Cooling Duct Insulation Jacket Temperature.....	10
Measuring Dewpoint Temperature.....	10
Testing Insulated Return Ducts.....	11
Scanning Walls for Air Leaks or Insulation Deficiencies.....	11
Testing Contactors (Starters).....	12
Testing Enclosed Relays.....	12
Testing Fuses and Buss Connections.....	12
Testing Electrical Connections.....	12
Testing Bearings.....	13
Testing Belts and Sheaves.....	13
Checking Hydronic Radiant Heat Applications.....	14
Testing Radiant Heat Applications.....	14
Testing Water Heater Insulation.....	14
Testing Steam Traps.....	14

# 561 HVACPro

## Users Manual

---

Measuring Grille, Register, or Diffuser Discharge Temperature .....	15
Verifying Thermostat/Room Sensor Accuracy .....	15
Checking for Blockage in Air-To-Air Evaporators or Condensers.....	15
Checking Superheat on Fixed Restrictor or Capillary Tube Equipped Evaporators .....	16
Checking Subcooling on Air-To-Air Systems With Expansion Valve Equipped Evaporators .....	16
Maintenance .....	17
Changing the Battery .....	17
Cleaning the Lens .....	17
Cleaning the Housing .....	17
Troubleshooting .....	17
CE Certification .....	17
Specifications .....	18

# ***561 HVAC PRO Infrared Thermometer***

## ***Introduction***

The Fluke Model 561 HVACPro Infrared Thermometer (hereafter, “the Thermometer”) can determine the surface temperature by measuring the amount of infrared energy radiated by the target’s surface or by contact using a thermocouple probe. The Thermometer was designed specifically for use in heating, ventilating, and air conditioning (HVAC) applications.

## ***Contacting Fluke***

To contact Fluke, call one of the following telephone numbers:

USA: 1-888-44-FLUKE (1-888-443-5853)

Canada: 1-800-36-FLUKE (1-800-363-5853)

Europe: +31 40 267 5200

Japan: +81-3-3434-0181

Singapore: +65-738-5655

Anywhere in the world: +1-425-446-5500

For USA Service: 1-888-99-FLUKE (1-888-993-5853)

Or, visit Fluke’s Web site at [www.fluke.com](http://www.fluke.com).

To register your product, visit [register.fluke.com](http://register.fluke.com).

**Safety Information**

**⚠ Warning**

A Warning identifies conditions and actions that pose hazards to the user. To avoid electrical shock or personal injury, follow these guidelines:

- **⚠ Do not point laser directly at eye or indirectly off reflective surfaces.**
- **Before using the Thermometer inspect the case. Do not use the Thermometer if it appears damaged. Look for cracks or missing plastic.**
- **Replace the batteries as soon as the battery indicator (🔋) appears.**
- **Do not use the Thermometer if it operates abnormally. Protection may be impaired. When in doubt, have the Thermometer serviced.**
- **Do not operate the Thermometer around explosive gas, vapor, or dust.**
- **Do not connect the optional external probe to live electrical circuits.**
- **To avoid a burn hazard, remember that highly reflective objects will often result in lower than actual temperature measurements.**
- **Do not use in a manner not specified by this manual or the protection supplied by the equipment may be impaired.**







**Caution**

To avoid damaging the thermometer or the equipment under test protect them from the following:

- **EMF (electro-magnetic fields) from arc welders, induction heaters, etc.**
- **Static electricity.**
- **Thermal shock (caused by large or abrupt ambient temperature changes- allow 30 minutes for the Thermometer to stabilize before use).**
- **Do not leave the Thermometer on or near objects of high temperature.**

Table 1 and Figure 1 show various symbols and safety markings that are on the Thermometer and in this manual.

**Table 1. Symbols**

Symbol	Explanation
	Risk of danger. Important information. See Manual.
	Warning. Laser.
	Conforms to requirements of European Union and European Free Trade Association (EFTA)
	Do not dispose of this product as unsorted municipal waste. Contact Fluke or a qualified recycler for disposal.
	Battery
 沪制01120009号	Chinese manufacturing mark for products manufactured in the Peoples Republic of China (PRC)

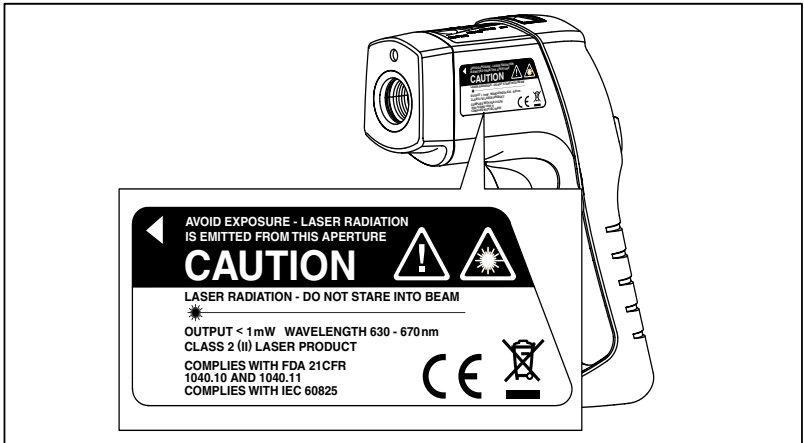

Figure 1. Symbols and Safety Markings

efh010f.eps

## Features

The Thermometer includes:

- Single-spot Laser Sighting
- Backlit Display
- Hard Case
- Current Temperature Plus MIN, MAX, DIF Temperature Displays
- Easy Emissivity Selector
- Type-K Thermocouple, Velcro Pipe Probe
- Two AA Batteries

Thermometer features are shown in Figure 2.

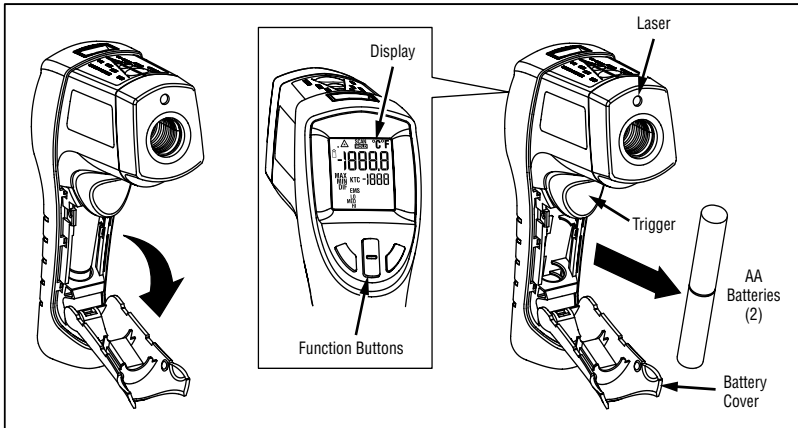

efh0071.eps

**Figure 2. Infrared Thermometer**

## **Display**

The primary temperature display reports the current or last IR temperature read until the 7-second hold time elapses.

The secondary temperature display reports current thermocouple temperature when a type-K thermocouple is attached. When a thermocouple is not connected, the small temperature display reports a choice of maximum, minimum, or difference between maximum and minimum temperature.

You can toggle through the minimum, maximum, and difference IR temperatures anytime the display is on. The MIN, MAX, and DIF temperatures are constantly calculated and updated when the trigger is pressed. After the trigger is released, the MIN, MAX, DIF temperatures are held for 7 seconds.

### *Notes*

*When the battery is low,  appears on the display.*

The last selection (MIN/MAX/DIF) is maintained on the secondary display even after the Thermometer has been turned off, providing the batteries have not failed.



# Infrared Thermometer

## Buttons and Connector

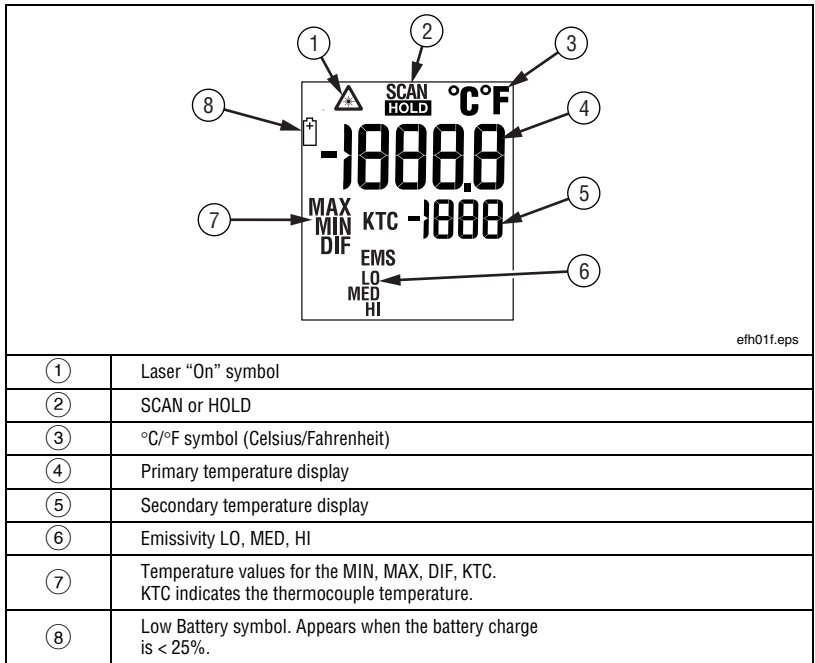

**Figure 3. Thermometer Display**

## Buttons and Connector

Button/Connector	Description
	Press  and then press  to toggle between the MIN, MAX, and DIF options.
	The  button is used to show the MIN, MAX, and DIF functions in the secondary display, whichever was pressed most recently.
	Selects the emissivity setting. You can toggle between LO (0.3), MED (0.7), or HI (0.95) using .
	K-type thermocouple probe used to make contact temperature measurement.

## **How the Thermometer Works**

Infrared thermometers measure the surface temperature of an opaque object. The Thermometer's optics sense infrared energy, which is collected and focused onto a detector. The Thermometer's electronics then translate the information into a displayed temperature reading which appears on the display. The laser is used for aiming purposes only.

## **Operating the Thermometer**

The Thermometer turns on when you press the trigger. The Thermometer turns off when no activity is detected for 7 seconds.

To measure temperature, aim the Thermometer at the target, pull and hold the trigger. Release the trigger to hold a temperature reading.

Be sure to consider distance-to-spot size ratio and field of view. The laser is used for aiming only.

## **Locating a Hot or Cold Spot**

To find a hot or cold spot, aim the Thermometer outside the target area. Then, slowly scan across the area with an up and down motion until you locate the hot or cold spot. See Figure 4.

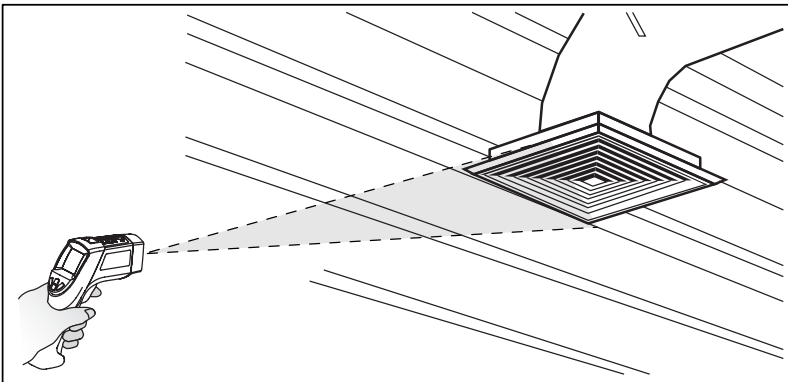

**Figure 4. Locating a Hot or Cold Spot**

eth014f.eps

## **Distance and Spot Size**

As the distance ( $D$ ) from the target being measured increases, the spot size ( $S$ ) of the area measured by the unit becomes larger. The spot sizes indicates 90 % encircled energy. The maximum  $D:S$  is obtained when the Thermometer is 900 mm (36 in) from the target resulting in a spot size of 75 mm (3 in). See Figure 5.

# Infrared Thermometer

## Operating the Thermometer

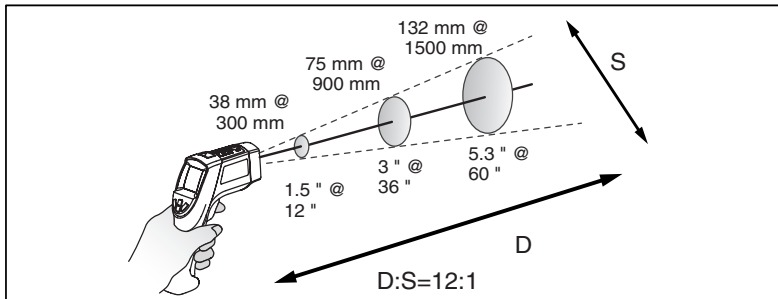

efh005f.eps

Figure 5. Distance and Spot Size

### Field of View

Make sure that the target is larger than the spot size. The smaller the target, the closer you should be to it. See Figure 6.

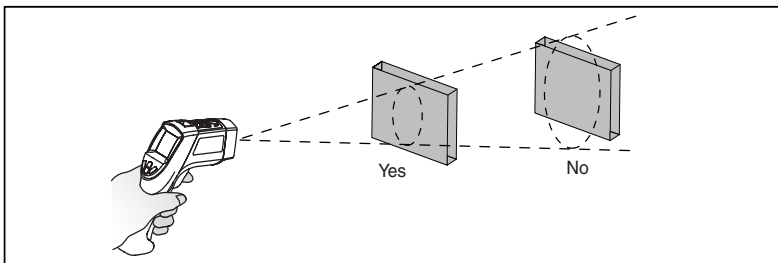

efh004f.eps

Figure 6. Field of View

### Emissivity

Emissivity describes the energy-emitting characteristics of materials. Most organic materials and painted or oxidized surfaces have an emissivity of about 0.95.

If possible, to compensate for inaccurate readings that may result from measuring shiny metal surfaces, cover the surface to be measured with masking tape or flat black paint (< 148 °C/300 °F) and use the high emissivity setting. Allow time for the tape or paint to reach the same temperature as the surface beneath it. Measure the temperature of the tape or painted surface.

If you cannot paint or use tape, then you can improve the accuracy of your measurements with the emissivity selector. Even with the emissivity selector, it can be difficult to get a completely accurate infrared measurement of a target with a shiny or metallic surface. Experimentation, using the probe to determine benchmark temperatures, and experience will help you choose the best setting for specific measurements. The Thermometer has three emissivity settings: low (0.3), medium (0.7), and high (0.95). Refer to Table 2. The reference to emissivity settings in the table are suggestions for typical situations. Your particular situation may differ.

**Table 2. Surface Emissivity**

Measured Surface	Switch Setting	Measured Surface	Switch Setting
<b>Aluminum</b>		<b>Iron, Cast</b>	
Oxidized	Low	Oxidized	High, Medium
Alloy A3003		Unoxidized	Low
Oxidized	Low	Molten	Low
Roughened	Low	<b>Iron, Wrought</b>	
<b>Brass</b>		Dull	High
Burnished	Low	<b>Lead</b>	
Oxidized	Low	Rough	Low
<b>Copper</b>		Oxidized	Low, Medium
Oxidized	Medium	<b>Molybdenum</b>	
Electrical Terminal Blocks	Medium	Oxidized	Low, Medium
<b>Haynes</b>		Nickel	
Alloy	Medium	Oxidized	Low
<b>Inconel</b>		<b>Platinum</b>	
Oxidized	High, Medium	Black	High
Sandblasted	Medium	<b>Steel</b>	
Electropolished	Low	Cold-Rolled	High
<b>Iron</b>		Ground Sheet	Medium
Oxidized	High, Medium	<b>Polished Sheet</b>	Low
Rusted	Medium	Zinc	
		Oxidized	Low

**Switching Between °C and °F**

Open the battery compartment and locate the switch positioned between the left side of the battery near the Thermometer wall. To toggle between °C and °F, use a small screwdriver or paper clip to move the switch to the desired position. See Figure 7.

# Infrared Thermometer

## Operating the Thermometer

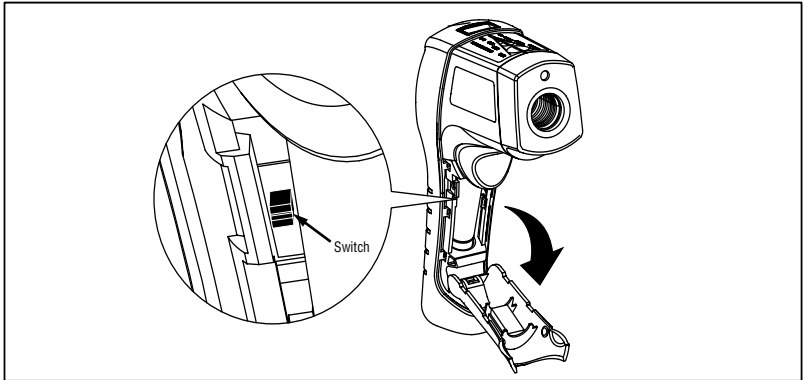

Figure 7. Switching Between °C and °F

efh012f.eps

### Using the Contact Temperature Probe

#### **⚠⚠ Warning**

**To avoid electrical shock or personal injury, do not connect the optional external probe to live electrical circuits.**

Connect the probe to the input on the top of the Thermometer. The probe temperature and KTC appears in the secondary display. The live infrared temperature continues to show in the primary display. Connect the temperature probe as shown in Figure 8.

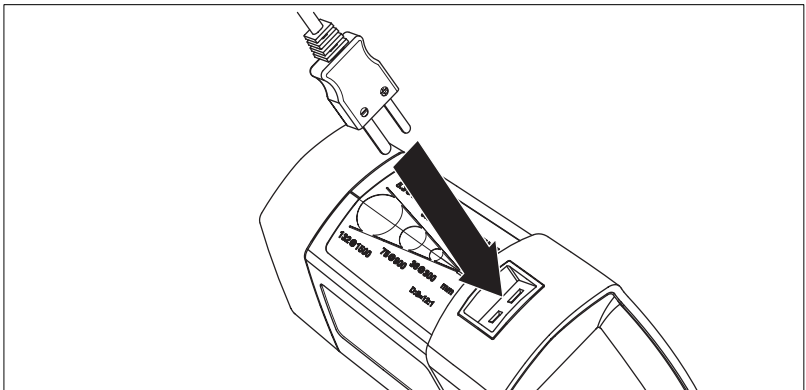

Figure 8. Connecting the Temperature Probe

efh009f.eps

Table 3 lists recommended Fluke temperature probes for use with the Thermometer:

**Table 3. Recommended Temperature Probes**

Probe	Usage
80PK-25	The piercing probe is the most versatile option. Good for checking air temperature in ducts, surface temperature under carpets/pads, liquids, thermometer wells, vent temperatures, and for penetrating pipe insulation.
80PK-1	The general purpose bead probe is an alternative, for quick, accurate surface temperatures and air temperatures within ducts, vent temperatures.
80PK-8	Pipe clamp probes (2) are essential for tracking continuously changing temperature differentials on hydronic tubing and pipe loops, and good for quick, accurate refrigerant temperatures.
80PK-26	The tapered probe is a good general-purpose gas and surface probe, with a good length and low mass tip casing for faster reaction to surface and air temperatures.
80PK-9	The insulation piercing probe provides a sharp tip to pierce pipe insulation and flat probe tip for good surface thermal contact, air temperatures within ducts, and vent temperatures.



### **HOLD**

The display will remain activated for 7 seconds after the trigger is released. HOLD appears in the upper middle of the display. When the trigger is pulled again, the Thermometer will begin measuring in the last function selected.

## **Typical Measurements**

This section describes a variety of measurements often performed by HVAC technicians. The backlight and laser are on whenever you are making readings with the Thermometer.

### **Measuring Heating/Cooling Duct Insulation Jacket Temperature**

1. Press  and then press  to select an emissivity setting.
  - HI emissivity for vinyl or PVC jacketed insulation
  - LO emissivity for foil faced insulation

*Note*

*Alternately, place black electrical tape on jacket surface. Scan to compare tape and insulation jacket temperatures. Adjust emissivity so insulation jacket temperature is closest to tape temperature.*

2. Connect the thermocouple probe. The probe hangs in the air to measure ambient air temperature in order to compare the temperature differential. Temperature deviation between the insulation jacket and ambient air temperature indicates leaky or ineffective insulation.
3. Scan the insulation jacket temperature.

### **Measuring Dewpoint Temperature**

The temperature of the duct insulation jacket at any single point is a critical temperature. If jacket temperature reaches dewpoint temperature, condensation will form.

- The most likely conditions for condensation formation are low dry bulb temperature and high wet bulb temperature (low temperature, high relative humidity).
- Use the Fluke 971 to measure the attic/crawlspace relative humidity and determine the dew point temperature. This is the temperature at which condensation will form on the duct wrap.
- Use the thermocouple to measure the duct wrap surface temperature. The temperature must remain above the attic or crawlspace dew point temperature at all times.
- In attics, the most likely time for dew point concerns is at night after the attic has cooled. Less heat in the attic means less heat gain by the duct wrap, which will be closer to the dew point temperature.
- Crawlspace are always cooler and problematic. Tight ductwork and liberal duct insulation is essential. Sealing openings, insulating perimeter walls, laying a continuous vapor barrier, and adding a low temperature, high capacity dehumidifier is often required to eliminate moisture and fungal problems.

### Testing Insulated Return Ducts

1. Connect a thermocouple probe.
2. Place the thermocouple probe in the return air stream at the return grille.
3. Read the return air temperature in the secondary temperature display.
4. Open a small test hole in the return duct at the air handler.
5. Place thermocouple probe into the return air stream at the air handler (For consistency, use the same probe as in step 2. 80PK-25, 80PK26 probes, or similar, are recommended for use through duct test holes.)
6. Read the return air temperature in the secondary display.
7. Seal the test hole when finished.



#### Note

*Temperature differential should be negligible (less than 1 to 2 degrees). If the temperature difference is too much, air leaks or insufficient duct insulation is indicated.*

8. Seal duct connections at grilles, boxes, plenums, transitions, and take-offs.
9. Retest.





If the test does not show satisfactory improvement, then remove duct insulation, seal duct seams and joints, re-wrap insulation, seal insulation facing at all seams to ensure continuous vapor barrier.

### Scanning Walls for Air Leaks or Insulation Deficiencies





1. Turn off heating, cooling, and blower.
2. Press  to select emissivity. Press  to select HI for painted surfaces or window surfaces.
3. Press  and select MIN when opposite side of wall is at lower temperature and or select MAX when opposite side of wall is at higher temperature.
4. Measure an interior partition wall surface temperature. Do not release the trigger. Record this temperature as your baseline (or benchmark) for a “perfectly” insulated wall.
5. Face the wall to be scanned. Stand 2.4 m (8 ft) away to scan an 20.3 cm (8 in) spot on the wall.
6. Scan horizontal rows of wall from top to bottom, or horizontal rows of ceiling from wall to wall. Look for greatest deviations from baseline temperature to identify problems. This completes the insulation test scan.

Turn on the blower (no heat, no cooling) and retest. If test results with the blower on are different than results with the blower off, this may indicate air leaks in conditioned envelope walls. The air leaks are caused by duct leaks that create a pressure differential across the conditioned space envelope.









### Testing Contactors (Starters)

1. Press  to select emissivity. Press  to select LO for bright contacts, or MED for darkened contacts.
2. Press  and then press  to select MAX.
3. Measure line and load side of one pole without releasing trigger.
4. A temperature difference between the line and load sides of a pole indicate increased resistance of one point and a contactor may be failing.

### Testing Enclosed Relays

1. Press  and then press  to set emissivity to LO for uninsulated connectors or HI for plastic encased relays or for bakelite enclosed relays or insulated connectors.
2. Press  and then press  to select MAX.
3. Start the scan.
4. Measure the relay casing, looking for hot spots.
5. Measure electrical connections on relay terminals looking for hot spots.



### Testing Fuses and Buss Connections

1. Press  and then press  to set emissivity to HI for paper covered fuse body or insulated connections.
2. Press  and then press  to select MAX.
3. Scan the paper covered length of fuse.
4. Without releasing the trigger, scan each fuse. Unequal temperatures between fuses may indicate voltage or amperage imbalance.
5. Press  and then press  to select LO, for metal fuses end caps and uninsulated buss connections.
6. Press  and then press  to select MAX.
7. Scan each end cap on each fuse.

#### Note

*Unequal temperatures or a high temperature indicates loose or corroded connection through the fuse buss spring clip.*

### Testing Electrical Connections

1. Press  and then press  to select LO emissivity for uninsulated connectors or buss connections or HI for insulated connections.

#### Note

*Conductors are typically smaller than the Thermometer's spot size. If the spot size is bigger than the connector, the temperature reading is the average within the spot.*

2. Scan the conductor, moving toward direction of electrical connector (quick connect, wire nut, buss connection, or lug).



### Testing Bearings





#### Warning

To avoid injury when testing bearings:





- Do not wear loose clothing, jewelry, or anything around neck when working around moving parts such as motors, belts, blower, and fans.
- Make sure an electrical disconnect is within reach and operating correctly and freely.
- Do not work alone.

#### Note

*It works best to compare two similar motors operating similar loads.*

1. Press  and then press  to select HI emissivity.
2. Press  and then press  to select MAX.
3. Enable motor and allow it to reach steady state operating temperatures.
4. Disable the motor if possible.
5. Measure the two motor bearing temperatures.
6. Compare the two motor bearing temperatures. Unequal temperatures or a high temperature can indicate a lubrication or other bearing problem that is resulting from excess friction.
7. Repeat the sequence for the blower bearings.





### Testing Belts and Sheaves

1. Press  and then press  to select HI emissivity.
2. Press  and then press  to select MAX.
3. Enable the motor and allow it to reach a steady state operating temperatures.
4. Aim the Thermometer at the surface to be measured. Direct the Thermometer to outside face of belt where it rides in sheave or to the side of sheave at outer edge, whichever is safer or allows easier use of the Thermometer.
5. Start recording temperature.
6. Slowly move the Thermometer up the belt toward second sheave.
  - If belt is slipping, sheave temperature will be high from friction.
  - If belt is slipping, belt temperature will remain high between sheaves.
  - If belt is not slipping, belt temperature will reduce between sheaves.
  - If inner surfaces of sheaves are not a true "V" shape, this indicates belt slippage and will continue to operate at elevated temperatures until sheave is replaced.
  - Sheaves must be properly aligned (including "pitch & yaw") for belt and sheaves to operate at appropriate temperatures. A straight edge or taut string, can be used to check alignments.
  - Motor sheave should operate at a temperatures consistent with blower sheaves.
  - If motor sheave is at a higher temperature at motor shaft than at outer circumference, belt is probably not slipping.
  - If outer circumference of sheave is at higher temperature than sheave at motor shaft, then belt is probably slipping and sheaves may be misaligned.

### Checking Hydronic Radiant Heat Applications

Radiant heat tubes in the floor will normally run parallel to the outside walls. Starting at the floor wall juncture, scan parallel to the wall while moving into the room away from the wall. Parallel to the outside







wall you should find parallel isothermal rows indicating the location of heat tubes below the surface. Perpendicular to the outside wall, you should find rising and falling temperatures at equal distances. High temperatures indicate you are scanning a heat tube beneath the floor surface, low falling temperatures indicate a space between the heat tubes.

1. Press  and then press  to select HI emissivity.
2. Press  and then press  to select MIN.
3. To locate radiant heat tubes in floor, temporarily elevate the loop temperature to create hotter spots for identifying tubing runs.
4. Before releasing trigger, press  to toggle between MIN, MAX, DIF floor temperatures and record the temperatures for future comparison and trending under similar conditions.

### Testing Radiant Heat Applications

1. Operate radiant heat loop until steady state conditions are achieved.
2. Attach the thermocouple to supply of radiant loop.
3. Record the supply temperature.
4. Attach thermocouple to return of radiant loop.
5. Record the return temperature.
6. Difference is Delta-T (temperature difference).
7. Repeat for each loop to zone and balance for equal Delta-T's.







### Testing Water Heater Insulation

1. Connect thermocouple probe to obtain ambient temperature near water heater.
2. Press  and then press  to select HI emissivity for vinyl jacketed insulation or painted metal jacketed water heaters.
3. Press  and then press  to select DIF.
4. Aim the Thermometer at the water heater.
5. Scan the water heater jacket.
6. Scan in horizontal rows from top to bottom
7. Press  and then press  to read MAX and DIF jacket temperatures. Record your readings.
  - The closer the jacket temperature is to ambient temperature, the less jacket losses there are.
  - Standby losses account for a majority of the water heater energy expenses. Increase water heater insulation to reduce standby losses.
  - Standby losses are losses when water is not being re-heated by the burners or the elements. When the water heater is idle (standing by) and no water is being drawn, heat loss through the jacket (and flue on oil/gas systems) are waste heat losses that can be reduced by increasing insulation and/or lowering the temperature setting.



### Testing Steam Traps

Steam traps open on low temperature to allow steam flow to trap. Steam traps close at steam temperatures to stop steam flow. As steam temperature drops, traps open to allow more steam flow and to return ("drain") condensate.





- If temperature is low in steam pipe, low in trap and low in condensate return, trap may be stuck closed. If temperature is high in steam pipe, high in trap, and high in condensate return, trap may be stuck open.
- If temperature is high in steam pipe, high in trap, and slightly lower in condensate return, trap is probably operating properly.

- If system pressure has been increased above design settings, this can result in symptom of trap failure (stuck open). Check steam pressure.
1. Press  and then press  to select HI emissivity for black iron pipe and painted traps.
  2. Press  and then press  to select DIF.
  3. Aim the Thermometer at the steam pipe.
  4. Scan steam pipe upstream of trap.
  5. Scan the steam trap. Scan downstream of trap on condensate return side.
  6. Press  and then press  and toggle to MIN, MAX, and DIF temperatures. Record your readings.



### Measuring Grille, Register, or Diffuser Discharge Temperature

1. Press  and then press  to select HI emissivity.
2. Aim the Thermometer at the discharge air grille, register, or diffuser.
3. Measure discharge temperature.
4. Release the trigger to freeze the temperature reading for 7 seconds and record the temperature.
5. Grille, register, or diffuser temperature should be equivalent to discharge temperature at the air handler.
6. Drill a sample hole in supply duct at air handler.
7. Connect thermocouple probe to Thermometer.
8. Insert thermocouple probe, such as the 80PK-25 or 26, into the supply duct.
9. Read supply air temperature on the secondary display.
10. Compare supply duct temperature to discharge air temperature. They should be nearly equivalent. If they are not, check for duct leakage or insulation problems.
11. Patch the sample hole.

### Verifying Thermostat/Room Sensor Accuracy

1. Insert the thermocouple probe into the Thermometer. Record ambient air temperature.
2. Press  and then press  to select HI emissivity.
3. Press  and then press  to select DIF.
4. Aim the Thermometer at the wall thermostat.
5. Compare the wall temperature reading to thermostat cover temperature and thermocouple air temperature reading.
6. Look for possible source of heat or heat sink that could be affecting thermostat accuracy.
7. The temperature of the thermostat cover and surrounding wall surfaces should be very nearly equivalent (DIF reading should be close to 0).

### Checking for Blockage in Air-To-Air Evaporators or Condensers

1. Remove panels to gain access to coil return bends or hairpins.
2. Press  and then press  to select LO emissivity for copper tube.
3. Start the refrigeration system.
4. Aim the Thermometer at coil return bends/hairpins.
5. Start recording temperature.
6. Take temperature of each return bend/hairpin.
  - All evaporator return bends/hairpins should be at or slightly above evaporator saturation temperature from the pressure/temperature chart.

- All condenser return bend/hairpins should be at or slightly less than condenser saturation temperature.
- If a group of return bends/hairpins do not conform to expected temperatures, that indicates a blocked or restricted distributor or distributor tube.

### **Checking Superheat on Fixed Restrictor or Capillary Tube Equipped Evaporators**

*Note*

*Superheat is a critical temperature.*

1. Ensure that filter and blower are clean and all registers are open and unobstructed.
2. Clean section of suction line 15.2 cm (6 in) upstream of compressor.
3. Attach the thermocouple probe to the suction line with Velcro strap or use an 80PK-8 Pipe Clamp Temperature Probe.
4. Connect low side gauge to suction line.
5. Start system and allow to run at least 10 minutes to reach a steady state condition.
6. Measure the wet bulb temperature in the return using a sling psychrometer or Fluke 971 humidity meter.
7. Aim the Thermometer to shady spot on the ground or at a piece of paper held in a shaded area and read outdoor temperature.
8. Determine evaporator saturation temperature from pressure-temperature chart
9. Read the suction line temperature on the secondary display.
10. Subtract saturation temperature from suction line temperature.
11. Correct superheat is based on outdoor temperature, return air wet bulb temperature, and 12.5 cubic meters/minute per metric ton (400 cfm per ton) of air moving across the evaporator.
  - Determine required superheat from manufacturer's superheat tables or calculator.
  - Add refrigerant to reduce superheat as necessary.
  - Recover refrigerant to increase superheat.

### **Checking Subcooling on Air-To-Air Systems With Expansion Valve Equipped Evaporators**

1. Ensure that filter and blower are clean and all registers are open and unobstructed.
2. Ensure that condenser is clean and dry.
3. Clean section of liquid line close to where liquid pressures can be read.
4. Attach furnished thermocouple probe to liquid line with Velcro fastener or use an 80PK-8 Pipe Clamp Temperature Probe.
5. Connect high side rating pressure gauge to liquid line.
6. Start system and allow to run at least 10 minutes to reach a steady state condition.
7. Determine condenser saturation temperature from pressure-temperature chart.
8. Read the liquid line temperature in the secondary display.
9. Subtract liquid line temperature from condenser saturation temperature. Correct subcooling is based primarily on equipment efficiency rating (EER) and pressure drop in liquid line due to friction and lift.
10. Determine required subcooling from manufacturer's specification.
11. Add refrigerant to increase subcooling or recover refrigerant to reduce subcooling.

## **Maintenance**

### **Changing the Battery**

To install or change the two AA batteries, open the battery compartment and insert the batteries as shown in Figure 2.

### **Cleaning the Lens**

Blow off loose particles using clean compressed air. Carefully wipe the surface with a moist cotton swab. The swab may be moistened with water.

### **Cleaning the Housing**

Use soap and water on a damp sponge or soft cloth.

### **⚠ Caution**

To avoid damaging the Thermometer, do NOT submerge it in water.

## **Troubleshooting**

<b>Symptom</b>	<b>Problem</b>	<b>Action</b>
--- (on display)	Target temperature is over or under range	Select target within specifications
	Low battery	Replace battery
Blank display	Possible dead battery	Check and/or replace battery
Laser does not work	1. Low or dead battery 2. Ambient temperature above 40 °C (104 °F)	1. Replace battery 2. Use in area with lower ambient temperature

## **CE Certification**

The Thermometer conforms to the following standards:

- EN61326-1 EMC
- EN61010-1
- EN60825-1 Safety

Certification testing was conducted using a frequency range of 80 to 1000 MHz with the instrument in three orientations.

## Specifications

### Infrared

Measurement Range .....	-40 °C to 550 °C (-40 °F to 1022 °F)
Spectral Range .....	8 to 14 microns
Accuracy.....	± 1 % or ± 1 °C (2 °F); < 0 °C (32 °F), ± 1 °C (2 °F) ± 0.1°/1° (Assumes ambient operating temperature of 23 to 25 °C (73 to 77 °F))
Repeatability.....	± 0.5 % of reading or ± 1°C (2 °F)
Response Time (95 %).....	500 ms
Distance to Spot (D:S).....	12:1
Emissivity Adjustment .....	Three settings: low (0.3), medium (0.7), high (0.95)

### Contact Probe

Probe Type .....	Wrap thermocouple type K probe with miniconnector
Measurement Range .....	0 °C to 100 °C (32 °F to 212 °F)
Probe Accuracy .....	± 2.2 °C (4 °F)
Display Resolution .....	± 0.1 °C (0.1 °F)
Secondary Display Information .....	Maximum, Minimum, Differential, KTC

### Laser

Sighting .....	Single point laser
Power .....	Class 2 (II) operation; Output <1 mW, wavelength 630 to 670 nm

### Electrical

Power Supply .....	2 AA Batteries (alkaline or NiCD)
Power Consumption.....	At least 12 hours battery life

### Physical

Weight.....	17.69 cm (6.965 in) H x 16.36 cm (6.441 in) L x 5.18 cm (2.039 in) W
Size.....	0.322 kg (0.7099 lb)
Total Length of Thermocouple .....	Approximately 100 cm (40 in)

### Environmental

Operating Temperature Range.....	0 °C to 50 °C (32 °F to 120 °F)
Relative Humidity .....	0 to 90 %, noncondensing up to 30 °C (86 °F)
Storage Temperature.....	- 20 °C to 65 °C (-4 °F to 150 °F)
Optional Accessories .....	Soft Case