



TEST & MEASUREMENT

2017 2018

Measure up



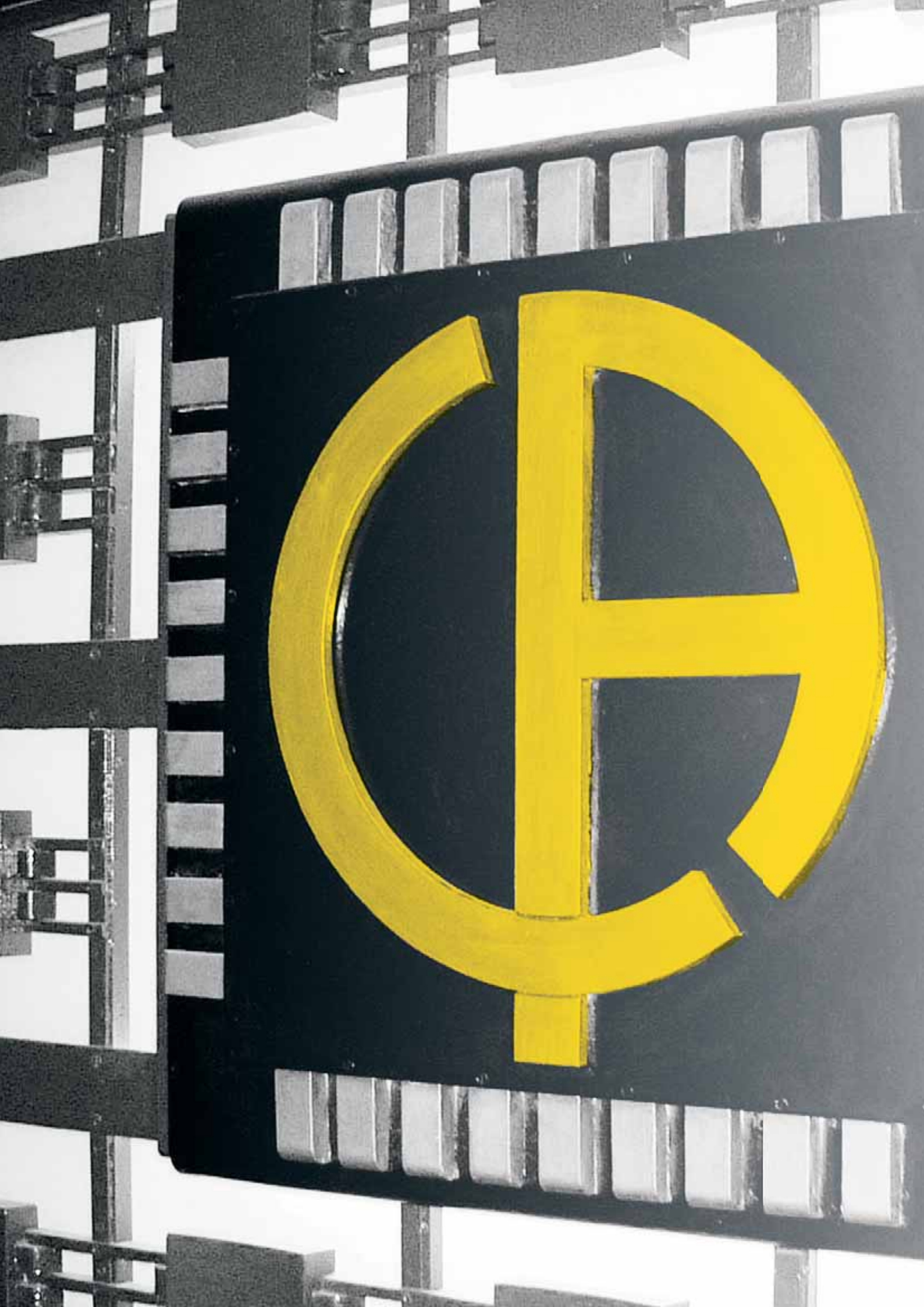

UNIVERSAL TEST & MEASUREMENT

Testers	24
Voltage detectors	28
Multimeters	31
Digital ammeters	40
Digital clamps	42

ELECTRICAL SAFETY

Installation testers	62
Multimeter clamps for leakage current	66
Insulation testers	77
Earth and resistivity testers	79
Electrical equipment testers	87
Other testers	91
Data processing software	100

ENERGY QUALITY & INSTALLATION MONITORING

Power and harmonics clamps	118
Power and energy quality analysers	122
Solar power analysers	126
Recorders	139
Data processing software	142

PHYSICAL & ENVIRONMENTAL MEASUREMENTS

Calibrators	154
Thermal cameras	157
Thermometers	164
Other physical and environmental measuring equipment	172

RADIOFREQUENCY & MICROWAVE MEASUREMENTS

LAN tester	199
Field meters	200
Directional wattmeters	202

LABORATORY & EDUCATIONAL EQUIPMENT

Training benches	207
Training cases	210
Other instruments	213

CURRENT MEASUREMENT

Current clamps	221
Flexible sensors and probes	224

ACCESSORIES

Protection, storage and transport	232
Connection technology	238
Adapters and probes	242
Fuses	243

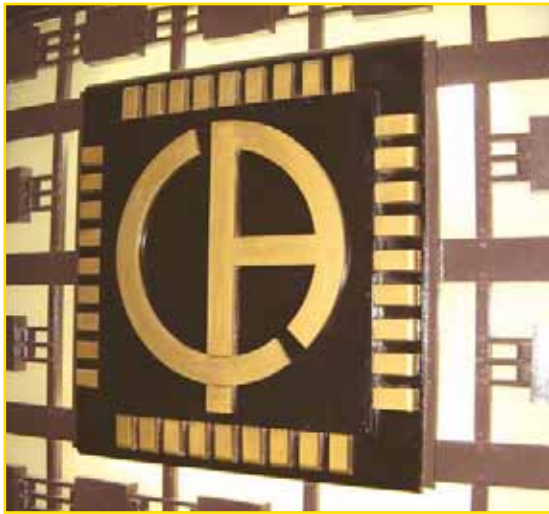

Logo on the company's former main gate

AN AMAZING STORY!

Every story starts somewhere. The story of the Chauvin Arnoux company as an inventor and manufacturer of measurement instruments since 1893 is rich in developments and innovations. Today, its products bear witness to and reflect the sociological and technological changes and the industrial innovations which marked the previous century. A fascinating story that explains why and how Chauvin Arnoux's image and personality evolved... in two colours.

It is often said that at the root of knowledge is language, or that the origin of an innovation was an idea... yet it is the individual, the person, who is really the source of knowledge and discoveries. This also applies to electricity, which was not invented in the 19th century, but discovered in the 6th century BCE by a Greek philosopher and scientist named Thales, the first person to note the electrostatic properties of amber.

From the beginning of the 19th century, there was the yellow of amber. Then manufactured goods began to include the yellow of brass and copper, materials used in measurement instruments, either for the casings of galvanometers or for the connections of electrical

measurement instruments. Beige was also introduced with the use of varnished wood in the casings, while black was reserved for the instruments' dials. Right from the start in 1893, the contrast between black and the yellow of varnished wood soon became the norm for the measurement instruments produced by Chauvin Arnoux.

In a relatively short time, between 1900 and 1936, with the development of new technologies and new techniques for working materials, yellow brass began to be used with black Bakelite, eventually spreading to nearly all our instruments.

Already known for its sense of design and the combination of its original colours yellow brass and



1895 reflection galvanometer



This calibration potentiometer dating from 1900 was used with a standard battery and a galvanometer like the one shown above. Its price was 195 francs!



The Monoc L



CdA 600 Polyclamp (1982)

ABOUT THE CHAUVIN ARNOUX GROUP

black, in its measurement instruments, Chauvin Arnoux reproduced these colours in its first corporate logo in 1927.

In the 1940s, many measurement instruments only used black or black and the silver-grey of ferrous metals, sometimes painted. Chauvin Arnoux adapted its original visual identity to suit the fashions of the time, which also corresponded to technical criteria for safety, life-span extension or weight considerations linked to the metal and the manufacturing process used.

The 1950s saw the arrival of rubber-like materials, used for the bases of portable instruments, and subsequently for the shockproof sheaths made of black neoprene, first designed and patented by Metrix® and Chauvin Arnoux in 1958. These shockproof sheaths later became widely used on the handheld instrument market.

With the 1970s came plastics technology. This was when Chauvin Arnoux launched worldwide its first innovative products made of black and yellow plastic: the CdA 8 tester in 1979, the CdA 600 multimeter clamp in 1982, followed by the whole range. Some earth testers, such as the Terca in 1985 and the Prowatt wattmeters in 1989, also had a yellow casing. **The combination of yellow and black** for on-site equipment began to spread with its use for safety signage and for identifying hazardous areas on site...

This encouraged Chauvin Arnoux to launch the well-known IMEG 500 or ISOL1000 series in Europe and then in the United States with the company's two colours.

The MAN'X 500 series launched by Chauvin Arnoux, the very first multimeters made of a flexible material, further strengthened the company's visual identity.

At about the same time, Metrix launched several products with yellow casings and black platens, including the instruments in its MX 44 series (1988) followed by the MX 51 series.

Over the years, Chauvin Arnoux has developed its visual identity across all its product ranges: its multimeters, wattmeters, megohmmeters and installation testers all bear the company's colours

One last remark about colours: while yellow is always seen as the colour of the sun and of certain kings or emperors in Asia, it is not so widely known that in physics, black is the symbol of a "black body", meaning a system which absorbs all the light it receives. Black and yellow? A historic tandem for Chauvin Arnoux which was the first company to use this pairing for its corporate visual identity in the early 20th century when it first designed its logo in 1927.

Axel Arnoux

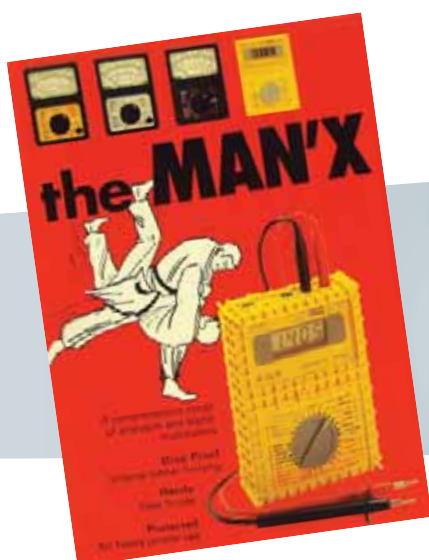

On both the French MICA multimeter in 1985 and the ANAGRAF American version available the same year, the yellow of Chauvin Arnoux is clearly in evidence.



MX 51



Founded in 1893 by **Raphaël Chauvin** and **René Arnoux**, **CHAUVIN ARNOUX** is an expert in the measurement of electrical and physical quantities in the industrial and tertiary sectors.

Total control of product design and manufacturing in-house enables the Group to innovate constantly and to propose a very broad product and service offering meeting all its customers' needs.

The Group's **quality policy** enables it to deliver products which comply with the specifications, as well as the international and national standards, in the metrological, environmental and user-safety sectors.

A FEW FIGURES

100 million euros
of sales revenues

10 subsidiaries across the world

900 employees

7 production sites

6 R&D departments
worldwide

11% of revenues
invested in R&D

4 FRENCH COMPANIES

selling the product and service offering

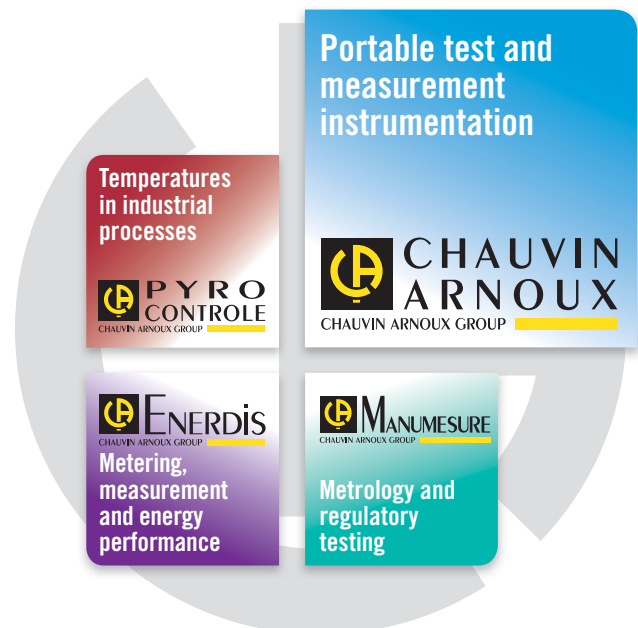

CHAUVIN ARNOUX IS A MAJOR PLAYER ON THE MEASUREMENT MARKET IN FRANCE AND INTERNATIONALLY.



7 PRODUCTION SITES

- 3 in Normandy (France)
- 1 in Lyon (France)
- 1 in Milan (Italy)
- 1 in Dover (USA)
- 1 in Shanghai (China)

10 SUBSIDIARIES

- Germany
- Austria
- China
- Spain
- Italy
- Lebanon
- Sweden
- Switzerland
- United Kingdom
- United States

CHAUVIN ARNOUX TEST & MEASUREMENT

CHAUVIN ARNOUX, the French international Group specialized in electrical measurement, relies on its **Chauvin Arnoux®** brand to propose a wide range of **portable measuring instruments**.

Its offering covers:

- **electrical measurement** (testers, multimeters and current clamps)
- **electrical safety testing** (insulation testers, ohmmeters, earth/ground testers)
- **power recording and analysis** (wattmeters and network quality analysers)
- **measurement of physical quantities** (thermal cameras, luxmeters, sound level meters)

Laboratory and educational instruments (training benches and cases) complete the scope of its expertise.

KNOW-HOW ACKNOWLEDGED IN ALL SECTORS OF ACTIVITY



Electrical production, transmission, distribution, installation & maintenance



Tertiary and industrial maintenance, diagnostics & testing



Improvement of energy efficiency



R&D and laboratory work



Education

QUALITY, STANDARDS AND ECO-RESPONSIBLE APPROACH



“Eco Conception” eco-design label for product development based on an eco-friendly approach



The Group's ISO 9001 certification for the design processes and ISO 14001 certification for the manufacturing and sales processes demonstrate its determination to reconcile business and protection of the environment.

Intertek

- Portable testers and multimeters
- Current clamps & multimeter clamps
- Insulation, earth and continuity testers
- Installation and electrical equipment testers
- Wattmeter-energy meters & electrical disturbance analysers
- Thermal cameras, thermometers, tachometers, field meters, luxmeters, etc.
- Recorders
- Training benches

In our laboratories, we carry out **strict quality inspections and tests at each stage in the design and manufacturing processes**: functional and metrological testing, mechanical and climatic testing, electromagnetic compatibility testing, electrical safety testing, ageing tests, etc.



A LINK BETWEEN YOU AND US

The Chauvin Arnoux Group has always attached great importance to its communication with the outside world. **Convinced that it is essential to dialogue with all its partner distributors and customers**, the Group uses **diverse communication**

media to maintain this link via magazines, technical journals, its website, its presence in the specialist press and the main industrial platforms.

CONTACT MEASUREMENT NEWS

A magazine for customers focusing on the Group's news and innovations, **Contact Measurement News** remains the best place for **technical information from the companies in the Group**. Sent out to 48,000 readers and available in the distribution networks all over the world, this thirty-page magazine is printed in colour on glossy paper and is available in three languages.



LES CAHIERS DE L'INSTRUMENTATION

"Les Cahiers de l'Instrumentation" is a magazine providing information for the education sector. It is published traditionally to coincide with the annual Educatec trade fair. Its twenty colour pages include practical exercises highlighting solutions, information on the standards and practical case studies involving measuring instruments, testers or energy-control equipment.

A firm favourite among teachers in technical education, this magazine serves as a bridge between students and the world of business.



40 years of communication to stay close to you and maintain your trust

- Contact Measurement News
- "Les Cahiers de l'instrumentation"
- Website 3.0



WEBSITE 3.0

Everyone agrees that the **Web 3.0** is a question of mobility, connected things and data. Internet access is increasingly nomadic. Information may be accessed anywhere, at any time. The Chauvin Arnoux Group has understood this and taken it fully on board, proposing a **new, totally redesigned website** which accompanies Internet users as they browse. **Finding,**

sharing and combining information are now much easier. A new conception of the web with a single purpose: **to offer users relevant, customized information** on each of the Group's brands: Chauvin Arnoux®, Enerdis®, Pyrocontrole® and Manumasure.



FOCUS ON IMAGES

Because a website without pictures is a website which isn't working, **chauvin-arnoux.com** gives pride of place to all the images on the site. Whether they involve corporate matters, applications, expertise or products, they place the company at the heart of a system which values complementarity between the different brands. They give the image of a **structured Group** by using **an identical presentation layout for each of the Group's companies.**

TRANSVERSE EXPERTISE

Multiplying the number of ways in to give internet users direct access to the information while limiting the number of clicks necessary: that's the challenge taken up by the Group. The **transverse nature of the four companies' skills** thus becomes obvious. Moving from one site to another, from one skill to another, via the history of the Group, the training schedule, the press and career opportunities, everything combines to make browsing **simple, effective and quick.**

A CLARIFIED PRODUCT OFFERING

Each company in the Group presents the scope of its offering by means of its products, expertise, applications or publications. Internet users have direct access to all the information linked to a product or complete range of products. The **search engine** quickly allows you find a product datasheet simply by entering a few keywords. You can also refine the search by using **"faceted" navigation** based on technical parameters which you check or uncheck, as required. In this way, internet users can **very quickly target the product** which meets their needs. This helps save precious time for visitors in a hurry.



The whole site is multilingual, available in French, English, Spanish, Italian and German. And each subsidiary has its own website which is consistent with the Group site.



CHAUVIN ARNOUX, A CERTIFIED TRAINING ORGANIZATION SINCE 1993

The Chauvin Arnoux Group proposes six one-day training modules. Whether you need theoretical training or practical experience based around a product, choose the market leader to train you and your staff.

New in 2016: a training course dedicated to energy auditing so that you perform the right measurements.



ENERGY AUDITS: OPT FOR THE RIGHT MEASUREMENTS

- The advantages of energy auditing
- Economical, environmental and regulatory constraints
- People authorized to perform an energy audit
- Towards a continuous improvement process: the ISO 50001 standard
- Choosing the right measuring tool
- Defining the potential sources of energy savings and the related measurements
- Implementing appropriate solutions



UNDERSTANDING AND OVERCOMING HARMONICS

- The basics of harmonic phenomena.
- Identifying and characterizing the sources of disturbances.
- Measuring and detecting the phenomena in experimental conditions using a harmonic analyser.
- The applicable standards and labels.
- Understanding the effect of harmonics on the electrical components using real cases.
- How to deal with harmonic disturbances.



ELECTRICAL INSTALLATIONS AND ENERGY QUALITY

- Excessive consumption of reactive energy leading to penalty payments.
- Loss of service continuity at the first fault on an IT system.
- Untimely tripping of the circuit-breakers protecting industrial electrical equipment.
- Untimely tripping of RCDs.
- Random fault on an electricity distribution system.



ELECTRICAL INSTALLATIONS AND NF C 15-100

- Properties and objectives of the earth/ground connection systems
- Behaviour of the earth/ground connection systems with regard to harmonics
- Insulation resistance measurement
- Electrical continuity measurements on protective conductors
- Resistance measurements on earth/ground electrodes
- Residual Current Device (RCD) testing



CERTIFICATION NUMBER 11.92.06217.92

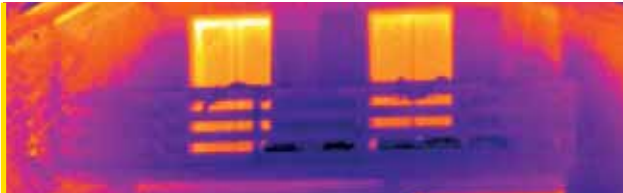

THERMOGRAPHY

- Understanding heat exchange phenomena.
- Measuring with an infrared thermographic camera.
- Interpreting the measurements.
- Overview of all the applications of thermography and the current obligations.



C.A 8336 NETWORK ANALYSER

- Setup and connections
- Presentation of the various measurements and functions: waveforms, harmonics, transients, alarms, etc.
- Recording and measurement campaigns
- Analysis of the measurement results
- Simulation exercise with the instrument on an electrical model

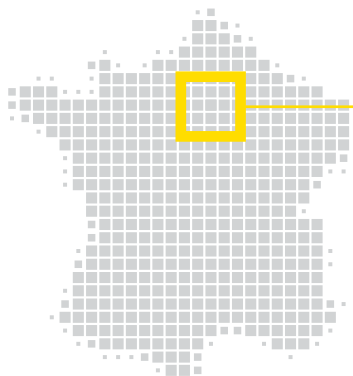

Training provided on the Chauvin Arnoux Group's historic site in the 18th Arrondissement of Paris

- Expert training instructors acknowledged in their fields
- Innovative demonstration equipment to understand and operate
- Limited number of participants for high-quality discussions

Detailed training schedule and registration form available from www.chauvin-arnoux.com or by sending a simple request to formation@chauvin-arnoux.com





TRAINING IS AN ESSENTIAL ADVANTAGE IN ANYONE'S CAREER.

- Favouring skills development
- Gaining access to the different levels of qualification
- Obtaining authorizations



EARTH/GROUND CONNECTION TESTING

- 

1 Soil resistivity and earth/ground measurement
C.A 6470N
- 

2 Measurements on pylons
C.A 6474
- 

3 On MV/HV lines
C.A 6472

INSTALLATION MAINTENANCE AND TESTING

- 

4 Separation of installations, voltage absence testing, phase sequence testing
C.A 773
- 

5 Testing of circuit-breakers and equipotential bonds
C.A 6240 - C.A 6292
- 

6 15 kV insulation testing
C.A 6555
- 

7 Current measurements
MA4000D



EARTH/GROUND CONNECTION TESTING

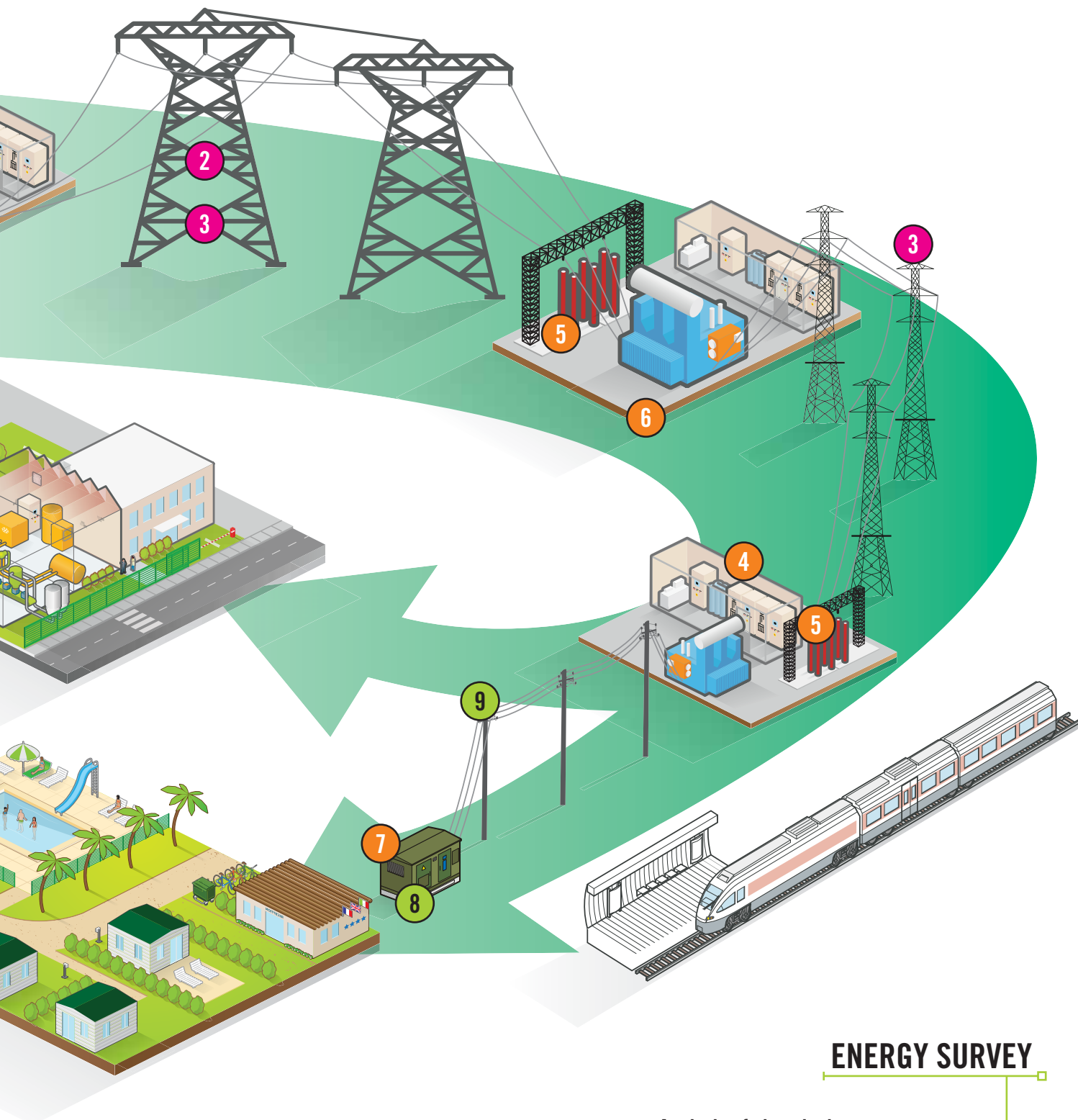

Electrical consumption monitoring

PEL105



8

Analysis of electrical network quality (flicker, over- and undercurrent/voltages/harmonics)

C.A 8336



9

ENERGY SURVEY



DETECTION OF ELECTRICAL DISTURBANCES



1

Energy quality analysis
C.A 8336



2

Recording of voltage drops and voltage surges
L261

INDUSTRIAL MAINTENANCE



3

Testing for electrical or mechanical overheating
C.A 1886

REGULATORY TESTING OF THE WORKING ENVIRONMENT



4

Noise
C.A 834



5

Lighting
C.A 1110



6

Humidity
C.A 1246

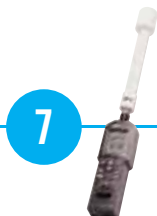

7

Electric fields
C.A 43

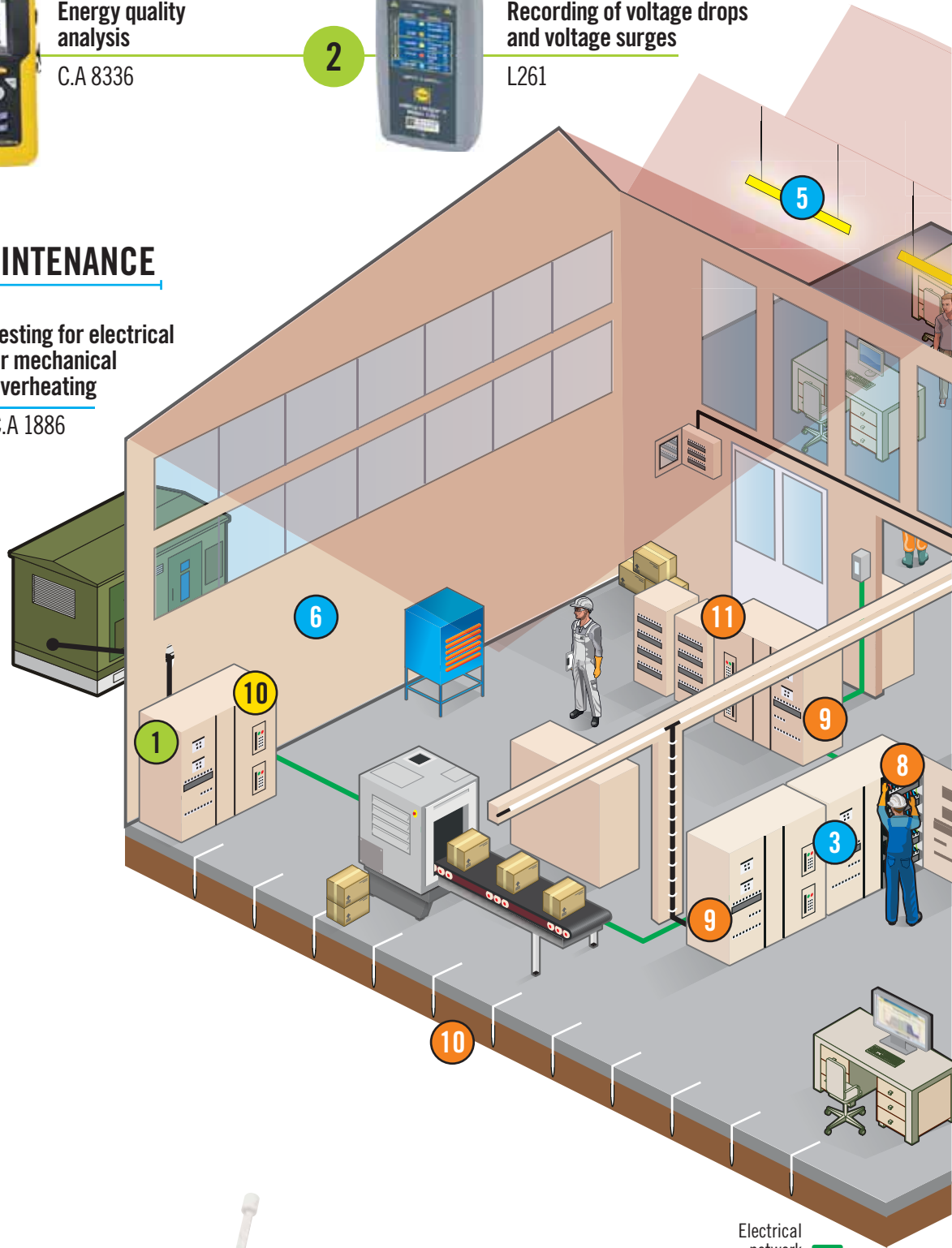

Electrical network



SAFETY OF PEOPLE

Voltage absence testing
C.A 762 IP2X



8

Detection of leakage currents
C.A 5275 + B102



9

Earth/ground testing
C.A 6417



10

Insulation testing
C.A 6524



11

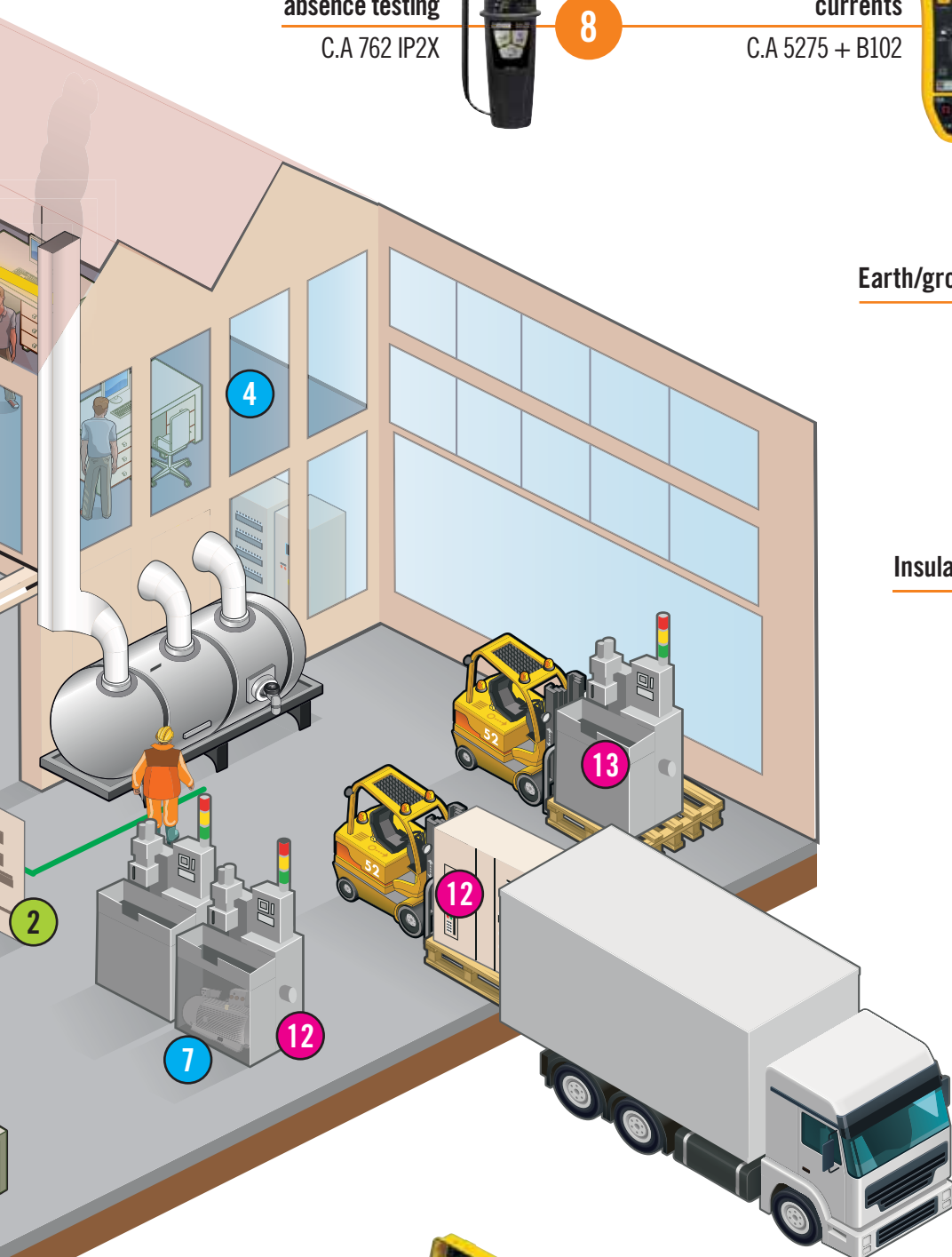

MANUFACTURING QUALITY CONTROL

Industrial machine testing
C.A 6121



13

Electrical cabinet testing
C.A 6155



12

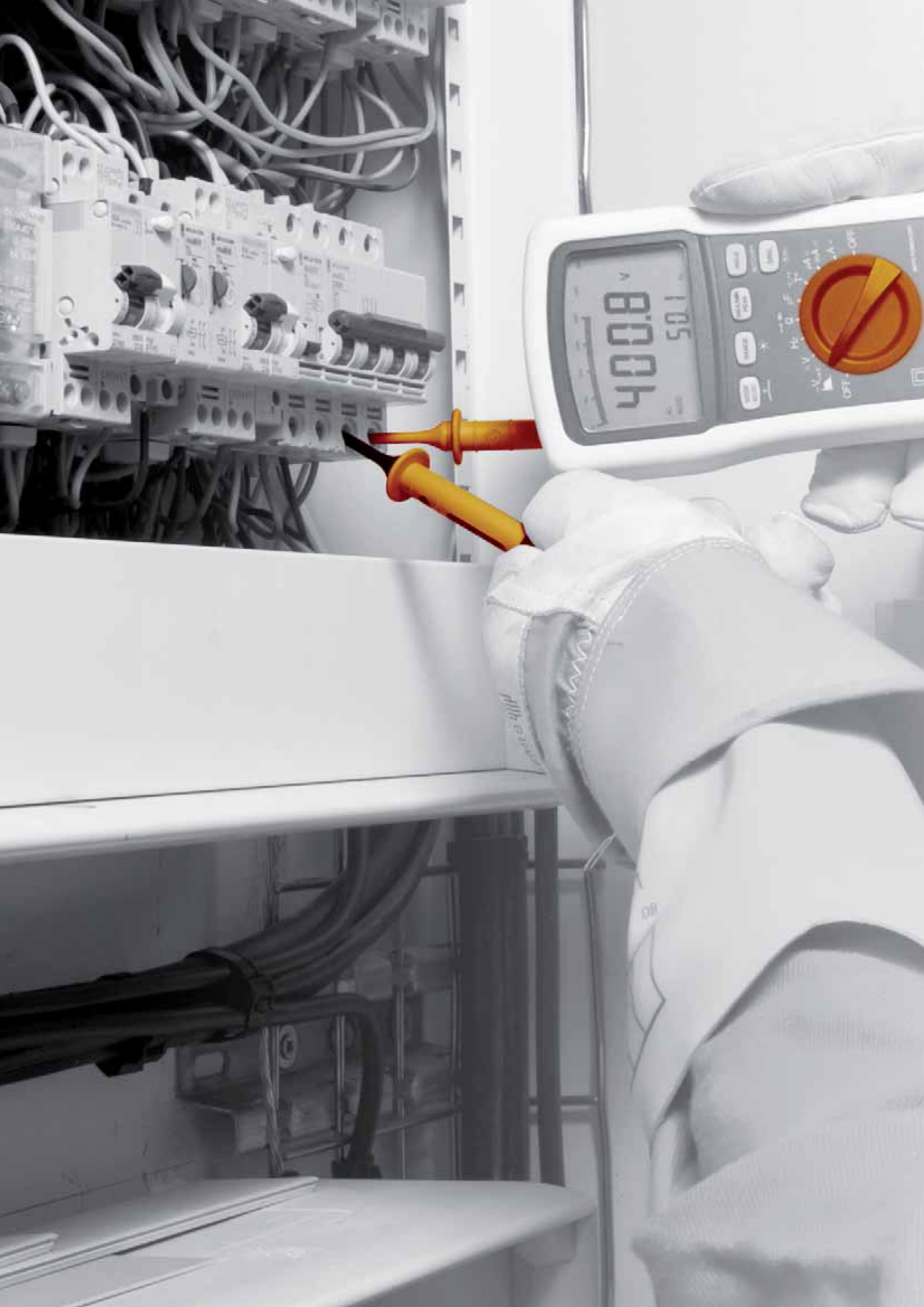



UNIVERSAL TEST & MEASUREMENT

Info and advice

20

Testers

24

Voltage detectors

28

Multimeters

31

Digital ammeters

40

Digital clamps

42

Accessories

46



THE STANDARDS

EN 60529

The **EN 60529 standard defines the level of tightness (leakproofing) of an instrument** against penetration by solids or water. The IP rating corresponds to the instrument's level of protection against penetration by solids (1st digit) and by water (2nd digit). The higher the rating, the more effective the protection. A product without protection corresponds to a rating of IP00 (minimum rating), whereas a product totally protected against penetration by solids and liquids would have a rating of IP68 (maximum rating).

IEC 61010

This international standard defines the safety rules for electrical measuring, control and laboratory instruments. It helps to **ensure** that the design and construction of the instruments **protect users and their environment** against: electric shocks, burns, mechanical hazards, the spread of fire from these instruments, excessive temperatures, etc.

For some types of instrument, this standard is completed by specific instructions.

The development of industrial and domestic equipment is increasing the hazards which may be encountered on an electrical installation, notably in terms of ever-higher voltage surges. On LV installations, where the voltages are limited to 1,000 VAC and 1,500 VDC, **the hazard levels depend the type of installation and the voltage level.**

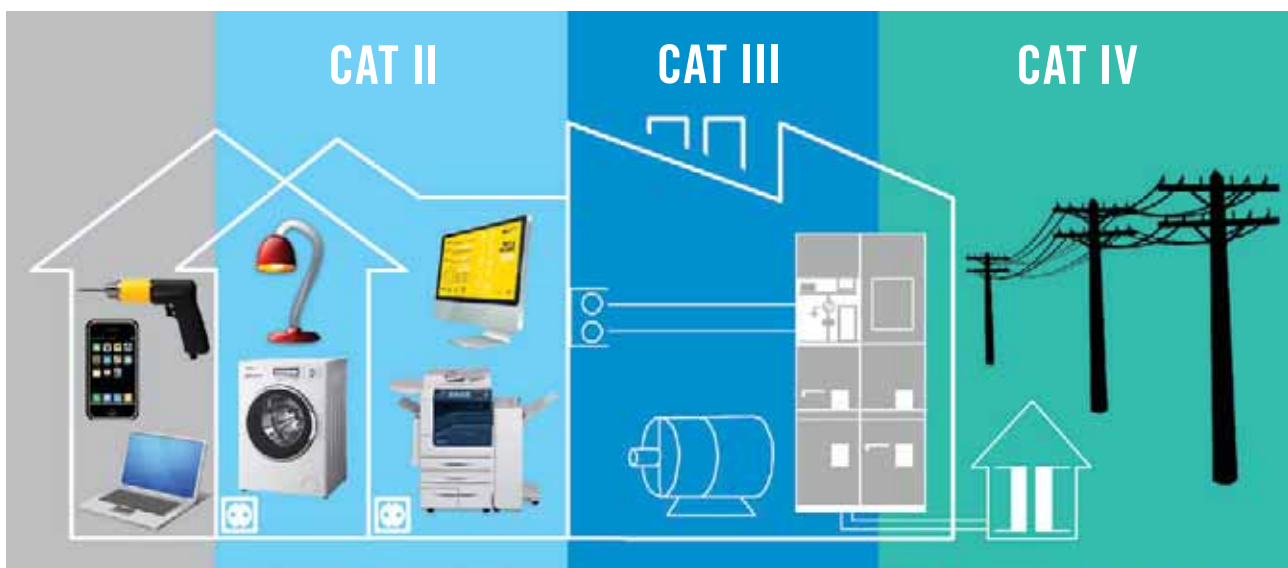

CAT II : Measurements on circuits connected directly to the low-voltage installation.

Examples: domestic distribution system, portable or domestic appliances and equipment, mains power sockets.

CAT III : Measurements on the building's installation.

Examples: fixed installations involved in industrial distribution and the input circuits for electrical maintenance of a building (lighting, lift, etc.).

CAT IV : Measurements at the source of the low-voltage installation.

Examples: direct distribution circuit, primary sources, overhead-line and cable systems, including distribution busbars and the associated protective equipment against voltage surges.



The international standards in the IEC 61010 family concern the safety rules for electrical measuring, control and laboratory instruments and their uses. More specifically, **the IEC 61010-031 standard** and its amendment A1 which define the safety rules **for measuring instruments** and accessories used with them. In the new edition which came into force on 1st March 2011, this standard has been completed with Chapter 13 covering "prevention of hazards linked to short-circuits and electric arcs":

This addition stipulates the following rules for work on CAT III and CAT IV installations:

- The conductive part of test probes must not exceed 4 mm in length
- The external surfaces of the jaws of crocodile clips must be non-conductive and the conductive parts must not be accessible when the clip is closed.

The IEC 61010-2-033 standard, first published on 09/02/2013, has brought changes concerning multimeters, multimeter clamps, etc.

Since 9th March 2015, these instruments have had to guarantee a minimum safety level corresponding at least to CAT III 300 V.

IEC 61557

This international standard specifies the electrical safety characteristics in 1,000 VAC and 1,500 VDC low-voltage distribution networks. It defines all the requirements for combined performance measurement and monitoring devices which measure and supervise the electrical parameters in electrical distribution networks. These requirements also define the performance levels in single and three-phase AC or DC networks with rated voltages less than or equal to 1,000 V AC or 1,500 V DC.

The parts of the IEC 61557 standard applicable to our areas of test and measurement include:

Part 1: IEC 61557-1 : General

Part 2: IEC 61557-2 : Insulation resistance

Part 3: IEC 61557-3 : Loop impedance

Part 4: IEC 61557-4 : Resistance of earth conductors and equipotential bonding

Part 5: IEC 61557-5 : Resistance to earth

Part 6: IEC 61557-6 : Effectiveness of residual current devices (RCDs) in TT, TN and IT networks

Part 7: IEC 61557-7 : Phase sequence

NF C 15-100

This is the **official French safety standard concerning the protection of low voltage electrical installations**, the protection of people and the ease of managing, operating and upgrading the installation. **Installations in housing** (house or apartment) **must comply with this standard.**

In particular, NF C 15-100 defines the protective systems, RCD circuit-breakers, wiring, number and type of lighting points and number of power outlets in each type of room (bathroom, kitchen...), etc.



TECHNICAL REMINDERS

NUMBER OF COUNTS (FOR MEASUREMENT)

This is one of the fundamental specifications of instruments using analogue-digital conversion. It is usually used to define **the measurement range and the resolution**, on the basis of the value chosen as the rated calibre.

MEASUREMENT RANGE

This indicates the limits within which a digital instrument maintains its specified characteristics. The measurements obtained are not subject to an error greater than the maximum tolerated error.

It is defined by a minimum measurable value and a maximum measurable value.

RATED CALIBRE

The calibre of an instrument is the **value of the quantity to be measured** which corresponds to the upper limit of the measurement range. For example, for an ammeter, if this upper limit is 5 A, its calibre is said to be 5 A.

RESOLUTION

This is the smallest measurable value difference. It is also the **value of one measurement count** or unit of quantification which is usually termed the "unit".

MINIMUM MEASURABLE VALUE (OR THRESHOLD)

This is the **smallest measurable value**. For an instrument with excellent conversion linearity, it may be the same as the resolution.

This is not always the case and the manufacturer should indicate it clearly, because **this minimum value also depends on the accuracy**, and particularly on the constant error.

When the constant error is too high, it becomes impossible to obtain valid measurements of very low values.

RMS: ROOT MEAN SQUARE

The term RMS (Root Mean Square) refers to the effective value. By definition, the effective value of any current is **the value of the DC current which would produce the same heating when flowing through a resistor**.

$$V_{\text{RMS}} = \sqrt{\frac{1}{T} \int_0^T V(t)^2 dt}$$

In the specific case of a sinusoidal quantity, application of the relation above gives:

$$V = V_{\text{peak}} \cos \omega t$$

$$V_{\text{RMS}} = \sqrt{\frac{1}{T} \int_0^T V_{\text{peak}}^2 \cos^2(\omega t)^2 dt} = \frac{V_{\text{peak}}}{\sqrt{2}}$$

The amplitude (V_c) of a voltage or of a sinusoidal current is equal to $\sqrt{2}$ times its RMS value ($V_c = \sqrt{2} V_{\text{RMS}}$).

It is crucial to know this RMS value in industrial environments; it is this value which is used to define a current.

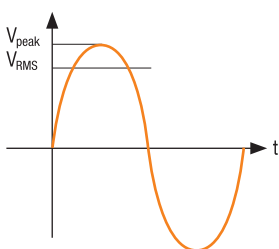

Thus, for a 230 V/50 Hz network:

$$V_{\text{RMS}} = 230 \text{ V}$$

$$V_{\text{peak}} = 325 \text{ V}$$

$$V_{\text{average}} = 207 \text{ V}$$

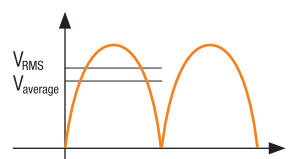

For a sinusoidal AC voltage

$$V_{\text{peak}} = V_{\text{RMS}} \times \sqrt{2}$$

$$V_{\text{average}} = 0.9 V_{\text{RMS}}$$



An "average value" measuring instrument measures the average value of a sinusoidal current, after rectification and filtering, and displays the RMS value after applying a coefficient of $1/0.9 = 1.111$

This indirect measurement method is simple and accurate but only valid for an undistorted sinusoidal current. It only tolerates distortion of a few percent.

This is why **"RMS" measuring instruments are increasingly widely used**. They rely on direct measurement principles: the thermal method (used mainly in metrology) and analogue or digital calculation methods requiring sophisticated electronic components.

PEAK VALUE – CREST FACTOR

The crest factor is expressed as follows $CF = V_{\text{peak}} / V_{\text{RMS}}$

This information complements the RMS value, allowing you to assess the distortion of a signal in qualitative terms.

For a sinusoidal signal, $CF = \sqrt{2} = 1.414$

ADVICE

When we speak of a 230 V network voltage, we are referring to an RMS value. For many years, the level of distortion caused by linear loads (incandescent lamps, heating) connected to the network was very low. The spread of non-linear loads (switching power supplies, light dimmers, variable speed-drives or compact fluorescent lamps) is calling this approach into question, as "pure" sinusoidal currents are becoming increasingly rare on the network.

Conventional measuring instruments (calculating the RMS value from the average value) are only accurate with sinusoidal currents, as a matter of principle. Otherwise, the measurement error may be as high as 50 %!

You are advised to opt for "RMS" measuring instruments which are capable of providing correct measurements, whatever the waveform of the current or voltage.

SAFETY RULES AND GOOD PRACTICES

- Use measuring instruments and accessories which are suitable for the application and the measuring conditions.

Prefer CAT IV instruments:

- They can withstand voltage surges which are up to 50 % greater than a CAT III product
 - CAT IV 1000 V provides protection against electric shocks up to 12,000 V, while CAT IV 600 V instruments protect up to 8,000 V.
 - Using a lower-category instrument means checking that the installation is equipped with protective systems (disconnecting switch, circuit-breaker, etc.) which are functional and in good condition. This is often the case... but not always!
 - **For outdoor or temporary installations or for installations upstream of the protective systems, CAT IV instruments must be used.**
- It is the weakest element which defines your level of protection. If you use accessories of a lower category or with a lower voltage than your measuring instrument, the global level of safety offered by your measuring system will be reduced.
 - Use accessories in perfect condition. Any accessory which is faulty, however slightly, must be replaced immediately as it can no longer guarantee your safety.
 - The fuses are protective elements. If you replace them with cheaper models or, even worse, with a metal element (copper wire, aluminium foil, etc.), you will no longer be protected against possible voltage surges on your installation.



CHOOSE YOUR TESTER



C.A 732
page 25



C.A 745 N
page 26



C.A 755
page 27



C.A 757
page 27

	C.A 732 page 25	C.A 745 N page 26	C.A 755 page 27	C.A 757 page 27
Strengths	Built-in torch Moulded body for exceptional handling	Phase test with a single test probe Continuity and resistance test	Casing with built-in compartment for stowing the test probes Measurements up to 1,000 V	MiniFlex® measurement accessory supplied Measurements up to 1,000 V
Display	Leds	LCD bargraph	Backlit digital display	Backlit digital display
Single-pole phase detection		■		
No-contact phase detection	■		■	■
AC or DC voltage		■	■	■
Audible continuity		■	■	■
Resistance		■	■	■
Diode			■	■
Capacitance			■	■
Current				■
Removable test probes		■	■	■
600V CAT III		■	■	■
1000V CAT III	■			



C.A 732

Ref.: P01191745Z

**1000 V
CAT III**

STRENGTHS

- No-contact phase detection
- Built-in torch
- Moulded body for exceptional handling

SPECIFICATIONS

	C.A 732
Detection threshold	$195 \text{ V}_{AC} \leq U \leq 265 \text{ V}_{AC}$
Audible beep	$U > 230 \text{ V}$
Operating frequency	50/60 Hz
Standards	IEC 61010 1000 V CAT III
Power supply	2 x 1.5 V LR03 batteries
Dimensions / weight	176 x 26 mm / 48 g

CONTENTS

- C.A 732 delivered in blister pack with 2 x 1.5 V LR03 batteries

ACCESSORIES / REPLACEMENT PARTS

- 1,5 V LR03 battery P01296032
- See all the accessories on page 46





C.A 745 N

Ref.: P01191743Z

600 V CAT III	IP 54
------------------	----------

STRENGTHS

- No risk of tripping high-sensitivity RCDs during phase/earth testing

SPECIFICATIONS

	C.A 745 N
Voltage test	12 V to 690 V ~ (7 segments)
Beep	U > 50 V~
Impedance	400 k Ω
Phase/neutral identification	Flashing "Ph" diode and intermittent beep for U > 100 V~
Operating frequency	DC and 50/60 Hz
Polarity test	"+" and "-"
Voltage protection	up to 1,100 V
Audible continuity test	R < 2 k Ω
Resistance test	2 k Ω to 300 k Ω (3 segments)
Standards	IEC 61010 600 V CAT III
Power supply	2 x 1.5 V LR03 batteries
Dimensions / weight	180 x 52 x 45 mm / 200 g

CONTENTS

- C.A 745 N delivered in blister pack with 2 x 1.5 V LR03 batteries and 2 removable test probes (red/black)

ACCESSORIES / REPLACEMENT PARTS

- 1.5 V LR03 battery _____ P01296032
- Set of red/black CAT III/IV test probes _____ P01102152Z
- See all the accessories on page 46



C.A 755 - C.A 757

Ref.: P01191755

P01191757

600 V
CAT IIIIP
54

STRENGTHS

- Measurements up to 1,000 V
- Backlit digital display
- Built-in compartment for stowing test probes in casing
- C.A 757: MiniFlex® measurement accessory supplied

SPECIFICATIONS

	C.A 755	C.A 757
Current		
Measurement range via current sensor		500 mA to 300 A (2 calibres)
Resolution		0.01 A to 0.1 A
DC voltage		
Measurement range	3 mV to 1,000 V – 4 calibres	
Resolution	1 mV to 1 V	
AC voltage		
Measurement range	100 mV to 1,000 V – 4 calibres	
Resolution	1 mV to 1 V	
Operating frequency	DC and 50/60 Hz	
Impedance	10 MΩ	
No-contact voltage detection	230 V 50/60 Hz conductor at a distance of approx. 5 cm	
Audible continuity test	R ≤ 30 Ω	
Resistance		
Measurement range	0.3 Ω to 30 MΩ – 6 calibres	
Resolution	0.1 Ω to 0.01 MΩ	
Capacitance		
Measurement range	400 pF to 30 mF	
Resolution	0.001 nF to 0.01 mF	
Standards	600 V CAT III, IEC 61010-1, IEC 61010-031, IEC 61010-032, IEC 61010-033	
Power supply	2 x 1.5 V batteries (LR03)	
Battery life	100 hours with alkaline batteries – Automatic standby after 10 minutes	
Dimensions / weight	180 x 52 x 45 mm / 200 g	

CONTENTS

- **C.A 755** delivered with 1 set of extra-fine test probes CAT III/CAT IV (red/black), 2 x 1.5 V LR3 alkaline batteries
- **C.A 757** delivered with 1 set of extra-fine test probes CAT III/CAT IV (red/black), 2 x 1.5 V LR3 alkaline batteries, 1 MiniFlex® sensor with a loop length of 250 mm, a connection cable 1 m long and a specific connector for C.A 757, 1 Velcro strap

ACCESSORIES / REPLACEMENT PARTS

- 1 set of black/red CAT III/IV test probes _____ P01102152Z
- 1.5 V LR03 alkaline battery (x 1) _____ P01296032
- See all the accessories on page 46



CHOOSE YOUR VOLTAGE DETECTOR/VOLTAGE ABSENCE TESTER (VAT)



C.A 742 / IP2X
page 29

C.A 762 / IP2X
page 29

C.A 771 / IP2X
page 30

C.A 773 / IP2X
page 30

600V CAT IV	<input checked="" type="checkbox"/>	<input checked="" type="checkbox"/>	<input type="checkbox"/>	<input type="checkbox"/>
1000V CAT IV	<input type="checkbox"/>	<input type="checkbox"/>	<input checked="" type="checkbox"/>	<input checked="" type="checkbox"/>
IP2X Version	<input checked="" type="checkbox"/>	<input checked="" type="checkbox"/>	<input checked="" type="checkbox"/>	<input checked="" type="checkbox"/>
Single-pole phase detection	<input checked="" type="checkbox"/>	<input checked="" type="checkbox"/>	<input checked="" type="checkbox"/>	<input checked="" type="checkbox"/>
AC or DC voltage test	<input checked="" type="checkbox"/>	<input checked="" type="checkbox"/>	<input checked="" type="checkbox"/>	<input checked="" type="checkbox"/>
Stray voltage detection	<input type="checkbox"/>	<input type="checkbox"/>	<input checked="" type="checkbox"/>	<input checked="" type="checkbox"/>
RCD tripping	<input type="checkbox"/>	<input type="checkbox"/>	<input checked="" type="checkbox"/>	<input checked="" type="checkbox"/>
Audible continuity	<input checked="" type="checkbox"/>	<input checked="" type="checkbox"/>	<input checked="" type="checkbox"/>	<input checked="" type="checkbox"/>
Extended continuity / Resistance	<input type="checkbox"/>	<input checked="" type="checkbox"/>	<input checked="" type="checkbox"/>	<input checked="" type="checkbox"/>
2-wire phase rotation	<input type="checkbox"/>	<input checked="" type="checkbox"/>	<input checked="" type="checkbox"/>	<input checked="" type="checkbox"/>
Removable test probe	<input checked="" type="checkbox"/>	<input checked="" type="checkbox"/>	<input checked="" type="checkbox"/>	<input checked="" type="checkbox"/>
Compliant with IEC 61243-3	<input checked="" type="checkbox"/>	<input checked="" type="checkbox"/>	<input checked="" type="checkbox"/>	<input checked="" type="checkbox"/>
Integrated Autotest	<input checked="" type="checkbox"/>	<input checked="" type="checkbox"/>	<input checked="" type="checkbox"/>	<input checked="" type="checkbox"/>
LED display	<input checked="" type="checkbox"/>	<input checked="" type="checkbox"/>	<input checked="" type="checkbox"/>	<input checked="" type="checkbox"/>
Digital display	<input type="checkbox"/>	<input type="checkbox"/>	<input type="checkbox"/>	<input checked="" type="checkbox"/>
Extended climatic class	<input type="checkbox"/>	<input type="checkbox"/>	<input checked="" type="checkbox"/>	<input type="checkbox"/>
IP65	<input checked="" type="checkbox"/>	<input checked="" type="checkbox"/>	<input checked="" type="checkbox"/>	<input checked="" type="checkbox"/>



C.A 742 - C.A 742 IP2X

Ref.: P01191742Z

P01191742D

C.A 762 - C.A 762 IP2X

Ref.: P01191762Z

P01191762D

600 V
CAT IV
IP
65
IEC
61243-3
NF C
18-510

STRENGTHS

- Full integrated Autotest
- Voltage test up to 690 Vac (16 2/3 – 800 Hz) / 750 Vdc
- IP2X versions available, compliant with NF C 18-510
- Removable test probe and lead
- Phase-sequence testing up to 400 Hz

SPECIFICATIONS

	C.A 742	C.A 762
Voltage detector		
Voltage	12 V _{AC} ≤ U ≤ 690 V _{AC} 12 V _{DC} ≤ U ≤ 750 V _{DC}	
Frequency	DC, 16 2/3 to 800 Hz	
Impedance	> 300 kΩ	> 400 kΩ
Max. current	3.5 mA _{RMS}	
Indication of polarity	Yes	
Hazardous voltage indication	The red ELV (Extra Low Voltage) LED indicates when the voltage is higher than the SELV (Safety Extra Low Voltage); the higher the voltage, the faster it flashes.	
Phase / Neutral identification	Above 120 V (45 - 65 Hz) Above 400 V (16 2/3 - 45 Hz)	
Continuity with buzzer		
Trigger threshold	100 Ω typical (150 Ω max.)	
Extended continuity test	-	2 kΩ, 60 kΩ, 300 kΩ
Test current	≤ 1 mA	
Open-circuit voltage	≤ 3.3 V	
Protection	Up to 1000 V	
Phase rotation	No	2-wire method
Ph/Ph voltage	-	50 V ≤ U ≤ 690 V _{AC}
Frequency	-	Between 45 and 400 Hz
Buzzer	Intermittent beep for voltage detection and continuous beep for continuity	
Standards and electrical safety	IEC 61010 600 V CAT IV IEC 61243-3 Ed.2 concerning Voltage Detectors/Voltage Absence Testers (VATs) IEC 61326-1, emission and immunity in industrial environments	
Protection of enclosure	Casing: IP65 Test probes (option): IP2X	
Climatic conditions	Use from -15 °C to +45 °C / 20 to 95 % RH	
Power supply	2 x 1.5 V batteries (AAA and LR03)	
Battery life	7,500 x 10 s measurements	7,000 x 10 s measurements
Dimensions / weight	163 x 64 x 40 mm / 210 g	

* Typical value with standard protective equipment (PPE)

ADDITIONAL INFO

- Don't forget the adapter for 2P+E sockets
C.A 751

P01101997Z

CONTENTS

- 1 voltage detector delivered with:
- 1 black Ø 2 mm test-probe lead with crystal safety cap
- 1 red Ø 2 mm test-probe lead with crystal safety cap
- 1 wrist-strap
- 2 x 1.5 V LR03 batteries
- The IP2X version is delivered with:
- 2 x IP2X Ø 4 mm test probes (red/black)
- 1 black cable 1.10 m long equipped with a probe-holder system
- 1 wrist strap
- 2 x 1.5 V LR03 batteries

ACCESSORIES / REPLACEMENT PARTS

- Red Ø 2 mm test probe _____ P01102008Z
- Crystal safety cap for Ø 2 mm test probe (x10) _____ P01102033
- See all the accessories on page 46



VOLTAGE DETECTORS / VOLTAGE ABSENCE TESTERS (VATS)



C.A 771 - C.A 771 IP2X

Ref.: P01191771

P01191771A

C.A 773 - C.A 773 IP2X

Ref.: P01191773

P01191773A

1000 V
CAT IV

IP
65

IEC
61243-3

NF C
18-510

STRENGTHS

- Full Autotest with indication of the type of fault
- Lighting of the point of measurement
- Automatic standby
- Extended climatic class
- IP2X version available, compliant with NF C 18-510

SPECIFICATIONS

	C.A 771	C.A 773
Display	LEDs	LEDs + Backlit digital display
Voltage detection		
Voltage	12 V _{AC} ≤ U ≤ 1000 V _{AC} 12 V _{DC} ≤ U ≤ 1400 V _{DC}	
Frequency	DC, 16 2/3 to 800 Hz	
Impedance	> 500 kΩ	
Max. current	3.5 mA RMS	
Polarity indication	Yes	
Stray voltage detection	Yes (by low-impedance load switching)	
RCD tripping	Yes (by low-impedance load switching) Approx. 30 mA to 230 V	
Redundant hazardous voltage indication	The ELV (Extra Low Voltage) LED indicates a voltage higher than the SELV (Safety Extra Low Voltage) with the flashing rate proportional to the voltage	
Phase / Neutral identification	Above 50 V (45 - 65 Hz) Above 150 V (16 2/3 - 45 Hz)	
Continuity & Resistance		
Buzzer trigger threshold	100 Ω typical (150 Ω max.)	100 Ω typical (150 Ω max.)
Extended continuity test (Resistance)	2kΩ, 60 kΩ, 300 kΩ	0,5 Ω to 2,999 kΩ
Test current / Open-circuit voltage	≤ 1 mA / ≤ 3.3 V	
Phase rotation	2-wire method	
Ph/Ph voltage	50 V ≤ U ≤ 1000 V _{AC} (45 - 400 Hz)	
Buzzer	Intermittent beep for voltage detection / Continuous beep for continuity	
Standards and electrical safety	IEC 61243-3:2009, EN 61243-3:2010 IEC 61010 1000 V CAT IV	
Enclosure protection	IP65	
Climatic conditions	-30 °C to +60 °C (Extended "class S")	-15 °C to +45 °C ("class N")
Battery life	> 5,000 x 10 s measurements	> 2,500 x 10 s measurements
Dimensions / weight	228 x 60 x 39 mm (without test probe) / 350 g approx.	

ADDITIONAL INFO

- Don't forget the universal measurement adapter for testing your 2P+E power sockets
C.A 753 P01191748Z

CONTENTS

- 1 voltage detector delivered with:
- 1 set of red/black Ø 2 mm removable test probes with crystal safety cap
- 1 test-probe protector
- 1 Velcro strap
- 2 x 1.5 V LR03 batteries
- The IP2X version is delivered with:
- 1 set of red/black IP2X Ø 4 mm removable test probes with crystal safety cap
- 1 Velcro strap
- 2 x 1.5 V LR03 batteries

ACCESSORIES / REPLACEMENT PARTS

- C.A 753 measurement adapter for 2P+E sockets P01191748Z
- Shoulder bag P01298076
- See all the accessories on page 46



CHOOSE YOUR ANALOGUE MULTIMETER



C.A 5001
page 32

C.A 5003
page 32

C.A 5005
page 32

C.A 5011
page 33

Analogue	■	■	■	■
Digital				■
Anti-parallax mirror	■	■	■	
4,000-count display				■
Backlighting				■
TRMS AC + DC measurement method				■
Max				■
Low-impedance calibre (LowZ)	■	■	■	
AC and DC current	■	■	■	■
Current via clamp			■	
µA calibre	■	■	■	
5 A calibre	■			
10 A calibre			■	■
15 A calibre		■		
Resistance	■	■	■	■
Audible beep	■	■	■	■
Frequency				■
dB	■	■	■	■
Fuse check LED	■	■	■	■
Voltage presence LED in ohmmeter mode				■



C.A 5001 - C.A 5003 - C.A 5005

Ref.: P01196521E

P01196522E

P01196523E

600 V
CAT III

IP
53

STRENGTHS

- "Fus" LED: HRC fuse check
- "Voltest™" LED: voltage presence in ohmmeter* mode
- Automatic tare in ohmmeter mode*
- μ A calibres
- Compact, shockproof casing with multi-purpose "Multistand™" articulated stand

* for C.A 5003 and C.A 5005

SPECIFICATIONS

	C.A 5001	C.A 5003 ⁽¹⁾	C.A 5005 ⁽¹⁾
DC voltage	8 calibres : 100 mV / ... / 1000 V ⁽²⁾		
AC voltage	5 calibres : 10 V / ... / 1000 V ⁽²⁾		
Internal resistance	20 k Ω /V		
Operating frequency	10 Hz ... 100 kHz depending on calibre		
DC current	5 cal. : 50 μ A / ... / 5 A	7 cal. : 50 μ A / ... / 15 A	6 cal. : 50 μ A / ... / 10 A
AC current	4 cal. : 5 mA / ... / 5 A	5 cal. : 1.5 mA / ... / 15 A	5 cal. : 3 A / ... / 300 A ⁽³⁾
Resistance	2 cal. : 10 k Ω and 1 M Ω		
Audible continuity test	R < 50 Ω		
Scale in dB for V _{AC}	0 ... +22 dB		
Typical accuracy ⁽⁴⁾	1.5% for V _{DC} • 2.5% for V _{AC} and A _{AC} & • 10% for Ω		
Power supply	1 x 1.5 V LR06 battery	1 x 9 V 6LR61 battery	
Battery life	10,000 x 15 s measurements	10,000 x 10 s measurements	
Electrical safety ⁽⁵⁾	IEC 61010-1 Edition 2 600 V CAT III		
Protection ⁽⁶⁾	HRC fuses 0.5 A and 5 A	HRC fuses 1.6 A and 16 A	HRC fuses 1 A and 10 A
Ingress protection	IP 40	IP 53	
Climatic conditions	-10 °C ... +55 °C and HR < 90%		
Dimensions / weight	160 x 105 x 56 mm / 500 g		

(1) Additional "Voltest™" function to check for the possible presence of a voltage during resistance measurement and audible continuity test - (2) Use limited to 600 V max. (3) Limited to 240 A max. by the MN 89 miniclamp - (4) In % of end-of-scale - (5) Degree of pollution 2 - (6) Electronic protection and HRC fuses for the current calibres with fuse test LED.

ADDITIONAL INFO

- Also delivered complete in a hard case:
 - C.A 5001 case _____ P01196521F
 - C.A 5003 case _____ P01196522F
 - C.A 5005 case _____ P01196523F
- The C.A 5005 is delivered with a current clamp for measurements up to 200 A_{AC}

CONTENTS

- C.A 5001 delivered with 1 set of silicone straight banana plug/elbowed banana plug leads, 1 set of safety test probes, 1 x 1.5 V LR6 battery
- C.A 5003 delivered with 1 set of silicone straight banana plug/elbowed banana plug leads, 1 set of safety test probes, 1 x 9 V 6LR61 battery
- C.A 5005 delivered with 1 MN89 AC clamp, 1 set of silicone straight banana plug/elbowed banana plug leads, 1 set of safety test probes, 1 x 9 V 6LR61 battery

ACCESSORIES / REPLACEMENT PARTS

- Accessories kit for electricians _____ P01295459Z
- CMI214S current measurement lead _____ P03295509
- See all the accessories on page 46



ADDITIONAL INFO

- Also available delivered complete in hard case: C.A 5011 case

P01196311F

C.A 5011

Ref.: P01196311E

600 V
CAT IV

IP
53

TRMS

STRENGTHS

- Extra safety with 2 LEDs: "Fus": HRC fuse test, "Voltest™": voltage presence in ohmmeter mode
- Two complementary readings: digital for accuracy, with backlighting, and analogue for quick reading
- Automatic AC/DC recognition
- Compact, shockproof casing with multi-purpose Multistand™ articulated stand

SPECIFICATIONS

	C.A 5011
DC and AC voltage	2 x 5 calibres 400 mV / ... / 1000 V ⁽¹⁾
Impedance	10 MΩ
Operating frequency ⁽²⁾	20 Hz / ... / 10 kHz
DC and AC current	2 x 6 calibres : 400 μA / ... / 10 A
Resistance ⁽³⁾	6 calibres : 400 Ω / ... / 40 MΩ
Audible continuity test ⁽³⁾	R < 400 Ω
Frequency	3 calibres : 4 kHz / ... / 400 kHz
Scale in dB for V _{AC}	-20 dB ... +16 dB
Max. value	Sur 500 ms
Typical accuracy ⁽⁴⁾	1% for V _{DC} and Ω, 1.5 % for A _{DC}
Power supply	1 x 9 V 6LR61 battery
Battery life	300 hours
Electrical safety ⁽⁵⁾	IEC 61010-1 Edition 2 600 V Cat IV
Protection ⁽⁶⁾	1 A and 10 A HRC fuses
Ingress protection	IP 53
Climatic conditions	-10 °C ... +55 °C and RH < 90 %
Dimensions / weight	160 x 105 x 56 mm / 500 g

(1) Use limited to 600 V max. (2) Crest factor ≤ 5 – (3) Additional Voltest™ function to check for the possible presence of a voltage – (4) In digital mode: 2.5 % – (5) Degree of pollution 2 – (6) Electronic protection and HRC fuses for the current calibres with fuse test LED.

CONTENTS

- 1 C.A 5011 multimeter
- 1 set of silicone straight banana plug/elbowed banana plug leads
- 1 set of safety test probes
- 1 x 9 V 6LR61 battery

ACCESSORIES / REPLACEMENT PARTS

- Accessories kit for electricians _____ P01295459Z
- PVC test-probe lead with insulated elbowed male plug Ø 4 mm (x 2) _____ P01295456Z
- See all the accessories on page 46



CHOOSE YOUR DIGITAL MULTIMETER



C.A 702
page 36

C.A 703
page 36

C.A 5231
page 37

C.A 5233
page 37

2,000-count display	■	■		
6,000-count display			■	■
Bargraph			■	■
Bi-mode bargraph (full scale - central zero)				
Backlighting			■	■
AVG measurement method	■	■		
TRMS AC/DC measurement method			■	■
TRMS AC+DC measurement method				
Autoranging	■	■	■	■
Max.				■
Peak				
AC and DC voltage up to 600 V	■	■		
AC and DC voltage up to 1,000 V			■	■
No-contact voltage detection	■	■	■	■
Low-impedance calibre (LowZ)			■	■
LowZ voltage with low-pass filter				
AC and DC current		■		■
Current via clamp			■	
µA calibre		■		
10 A calibre				■
Resistance	■	■	■	■
Audible continuity	■	■	■	■
Semi-conductor test	■	■	■	■
Frequency				■
Capacitance				■
Temperature				■
CAT III 1000 V	■	■	■	
CAT IV 600 V	■	■	■	■



CHOOSE YOUR DIGITAL MULTIMETER



C.A 5271
page 38

C.A 5273
page 38

C.A 5275
page 39

C.A 5277
page 39

C.A 5271	C.A 5273	C.A 5275	C.A 5277	Feature
				2,000-count display
■	■	■	■	6,000-count display
■		■	■	Bargraph
	■	■	■	Bi-mode bargraph (full scale - central zero)
	■	■	■	Backlighting
				AVG measurement method
■	■	■	■	TRMS AC/DC measurement method
		■	■	TRMS AC+DC measurement method
■	■	■	■	Autoranging
	■	■	■	Max.
			■	Peak
				AC and DC voltage up to 600 V
■	■	■	■	AC and DC voltage up to 1,000 V
				No-contact voltage detection
■	■	■	■	Low-impedance calibre (LowZ)
■	■	■	■	LowZ voltage with low-pass filter
■	■	■	■	AC and DC current
				Current via clamp
		■	■	µA calibre
■	■	■	■	10 A calibre
■	■	■	■	Resistance
■	■	■	■	Audible continuity
■	■	■	■	Semi-conductor test
	■	■	■	Frequency
	■	■	■	Capacitance
	■		■	Temperature
■	■	■	■	CAT III 1000 V
■	■	■	■	CAT IV 600 V



ACCESSORIES / REPLACEMENT PARTS

- 1.5 V LR03 battery P01296032
- 200 x 100 x 40 mm soft case P01298065Z
- See all the accessories on page 46

C.A 702 - C.A 703

Ref.: P01191739Z P01191740Z



STRENGTHS

- Pocket format
- Built-in test probes
- Easy to handle and safe
- Built-in torch

SPECIFICATIONS

	C.A 702	C.A 703
Display	2,000 counts	
Calibre selection	Automatic (AUTORANGE)	
V _{DC} / accuracy	200 mV / ± 0.5 % R + 3 D 2.000 V; 20.00 V; 200.0 V; 600 V / ± 1.2 % R + 3 D > 600 V / outside specifications	
V _{AC} / accuracy (40-400 Hz)	2.000 V; 20.00 V / ± 1.0 % R + 8 D 200.0 V; 600 V / ± 2.3 % R + 10 D > 600 V / outside specifications	
No-contact voltage detection	Yes	Yes
I _{DC} / accuracy Protection		200.0 µA; 2.000 µA ± 2.0 % R + 8 D 20.00 mA; 200.0 mA ± 2.0 % R + 8 D 200 mA / 500 V electronic fuse
I _{AC} / accuracy Protection		200.0 µA; 2.000 µA ± 2.5 % R + 10 D 20.00 mA; 200.0 mA ± 2.5 % R + 10 D Protection 200 mA / 500 V Electronic fuse
Resistance • Accuracy • Protection	200.0 Ω / ± 0.8 % R + 5 D • 2.000 kΩ. 20.00 kΩ. 200.0 kΩ / ± 1.2 % R + 5 D 2.000 MΩ / ± 5.0 % R + 5 D 20.00 MΩ / ± 10.0 % R + 5 D • 600 V _{RMS}	
Diode test • Test signal • Protection	1.999 V • V _{Test} ≤ 1.5 V • I _{Test} ≤ 1 mA • 600 V _{RMS}	
Audible continuity • Buzzer • Protection	199.9 Ω • R < approx. 60 Ω • 600 V _{RMS}	
Torch	Yes	Yes
Standards	IEC 61010 1000 V CAT III / 600 V CAT IV	
Power supply	2 x 1.5 V LR03 batteries	
Miscellaneous	Built-in test-probe leads	
Dimensions / weight	104 x 55 x 32.5 mm / 145 g	

CONTENTS

- C.A 702 and C.A 703 delivered with:
- 2 x 1.5 V LR03 batteries



C.A 5231 - C.A 5233

Ref.: P01196731

P01196733



STRENGTHS

- Compact and ergonomic
- AC/DC voltage up to 1,000 V
- AC/DC current up to 600 A with 1,000/1 current clamp (option)

SPECIFICATIONS

	C.A 5231	C.A 5233
Display	6,000-count display + 61-segment bargraph	
Backlighting	Yes	
Acquisition	True RMS AC	
Autorange / Manual range	Yes / Yes	
Best accuracy	0.02%	
AC voltage	6 calibres / 1,000 V / resolution: 0.01 mV	
LowZ AC voltage	Yes	
DC voltage	6 calibres / 1,000 V / resolution: 0.01 mV	
AC/DC current	With 1 AC or DC clamp (1 mV/A) as an option 1 calibre: 600 A Resolution: 0.1 A	2 calibres: 10 A / 6 A Resolution: 0.001 A
Resistance measurement	6 calibres / 60 MΩ / resolution: 0.1 Ω	
Audible continuity / Diode test	Yes / Yes	
Frequency Duty cycle	3 calibres: up to 3 kHz Yes	
Capacitance	6 calibres / 1,000 μF Resolution: 0.01 nF	
Temperature	2 calibres -20 °C to 760 °C -4 °F to 1,400 °F Resolution: 0.1°	
No-contact voltage detection (NCV)	Yes	Yes
Display Hold	Yes	Yes
Relative mode	Yes	
Min-Max	Yes	
Power supply	1 x 9 V 6LR61 battery	
Ingress protection	IP54	
Standards	IEC 61010-1, IEC 61010-2-033 CAT IV 600 V / CAT III 1000 V	IEC 61010-1, IEC 61010-2-033 CAT IV 600 V / CAT III 600 V
Dimensions / weight	155 x 75 x 55 mm / 320 g	

ADDITIONAL INFO

- The C.A 5231 can also be delivered complete with its MINI03 100 A_{ac} current clamp:
C.A 5231 complete kit _____ P01196734

CONTENTS

- C.A 5231 delivered with:
 - 1 set of red/black test-probe leads
 - 1 x 9 V 6LR61 battery
- C.A 5233 delivered with:
 - 1 set of red/black test-probe leads
 - 1 TC-K adapter for DMM
 - 1 wire K thermocouple
 - 1 x 9 V 6LR61 battery

ACCESSORIES / REPLACEMENT PARTS

- Accessories kit for electricians _____ P01295459Z
- PVC test-probe lead, insulated elbowed male plug Ø 4 mm (x 2) _____ P01295456Z
- See all the accessories on page 46



ADDITIONAL INFO

- 5 measurements / s
- 12-bit converter
- 3-year warranty

CONTENTS

- **C.A 5271** delivered with a set of banana leads, a set of test probes, a 9 V battery, a startup guide and a CD containing the User Manual
- **C.A 5273** same as **C.A 5271** plus a K-thermocouple temperature sensor

C.A 5271 - C.A 5273

Ref.: P01196771

P01196773



STRENGTHS

- Large 6,000-count display
- Double backlit display
- Temperature and capacitance measurements
- Bargraph central zero mode
- Min/Max memorization

SPECIFICATIONS

	C.A 5271	C.A 5273
Display	6,000 counts	2 x 6,000 counts, backlit
Bargraph (63 elements)	Yes	Bi-mode (full scale / central zero)
Acquisition	TRMS AC / DC	
Measurement rate	5 measurements / second	
Automatic / manual ranges	Yes / No	Yes / Yes
AC/DC voltage	600.0 mV / 6.000 V / 60.00 V / 600.0 V / 1,000 V	
Typical accuracy (V _{DC})	0.2% + 2 cts	
Bandwidth (V _{AC})	40 Hz to 3 kHz	
LowZ AC voltage	Low-impedance setting with Low-pass Filter	
AC/DC current	6.000 A / 10.00 A (20 A/30 s)	
Resistance measurement	600.0 Ω / 6,000 Ω / 60.00 kΩ / 600.0 kΩ 6.000 MΩ / 60.00 MΩ	
Audible continuity / Diode test	Yes / Yes	
Frequency	No	600.0 Hz / 6.000 kHz / 50.00 kHz
Capacitance	No	8 cal.: 6.000 nF to 60.00 mF
Temperature	No	-59.6 °C to +1,200°C -4°F to +2,192 °F
Hold	Yes	
Min / MAX (100 ms)	No	Yes
Automatic power-off	Yes (deactivatable)	
Safety	IEC 61010-1, IEC 61010-2-033 CAT IV 600 V / CAT III 1000V	
Ingress protection	IP54	
Power supply	1 x 9V 6LR61 battery	
Dimensions / weight	90 x 190 x 45 / 400 g	

ACCESSORIES / REPLACEMENT PARTS

- Accessories kit for electricians _____ P01295459Z
- PVC test-probe lead, insulated elbowed male plug Ø 4 mm (x 2) _____ P01295456Z
- See all the accessories on page 46



C.A 5275 - C.A 5277

Ref.: P01196775

P01196777



STRENGTHS

- 10 μ V resolution
- Current measurement from 1 μ A
- Measurement of ionization currents
- Min / Max / Peak+ / Peak- acquisition
- Differential (Δ X) and relative (Δ X / X%) measurements

SPECIFICATIONS

	C.A 5275	C.A 5277
Display	2 x 6,000 counts, backlit	
Bargraph	63 elements, bi-mode (full scale / central zero)	
Acquisition	TRMS AC / DC / AC+DC	
Measurement rate	5 measurements / second	
Automatic / Manual ranges	Yes / Yes	
AC/DC/AC+DC voltage	60.00 mV / 600.0 mV / 6 V / 60.00 V / 600.0 V / 1,000 V	
Typical accuracy (V _{oc})	0.09% + 2 cts	
Bandwidth (V _{ac})	40 Hz to 10 kHz	
LowZ AC voltage	Low-impedance setting with Low-pass Filter	
AC/DC/AC+DC current	6,000 μ A / 60.00 mA / 600.0 mA / 6,000 A / 10.00 A (20 A / 30 s)	
Ionization current	0.2 μ A to 20.0 μ Ac	
Resistance measurement	600.0 Ω / 6,000 Ω / 60.00 k Ω / 600.0 k Ω / 6,000 M Ω / 60.00 M Ω	
Audible continuity / Diode test	Yes / Yes	
Frequency	600.0 Hz / 6,000 kHz / 20.00 kHz	
Capacitance	6,000 nF / 60 nF / 600 nF / 6 μ F / 60 μ F / 600 μ F / 6 mF / 60 mF	
Temperature	No	-59.6 $^{\circ}$ C to +1,200 $^{\circ}$ C / -4 $^{\circ}$ F to 2,192 $^{\circ}$ F
Hold	Yes	
Min / MAX (100 ms)	Yes	
Peak+ / Peak- (1 ms)	No	Yes
Differential (Δ X) / RELative (Δ X/X%) measurement	No	Yes
Automatic power-off	Yes (deactivatable)	
Safety	IEC 61010-1, IEC 61010-2-033 / CAT IV 600 V / CAT III 1000 V	
Ingress protection	IP54	
Power supply	1 x 9 V 6LR61 battery	
Dimensions / weight	90 x 190 x 45 / 400 g	

ADDITIONAL INFO

- 5 measurements / s
- 12-bit converter
- 3-year warranty

CONTENTS

- C.A 5275 delivered with a set of banana plugs, a set of test probes, a 9 V battery, a shoulder bag, a MultiFix mounting accessory and a startup guide
- C.A 5277 same as C.A 5275 plus a K-thermocouple temperature sensor

ACCESSORIES / REPLACEMENT PARTS

- Accessories kit for electricians _____ P01295459Z
- PVC test-probe lead, insulated elbowed male plug \varnothing 4 mm (x 2) _____ P01295456Z
- See all the accessories on page 46



CHOOSE YOUR AMMETER WITH FLEXIBLE CURRENT SENSOR



MA400D-170
page 41



MA400D-250
page 41



MA4000D-350
page 41

Clamping Ø 45 mm	<input checked="" type="checkbox"/>		
Clamping Ø 70 mm		<input checked="" type="checkbox"/>	
Clamping Ø 100 mm			<input checked="" type="checkbox"/>
AC current	<input checked="" type="checkbox"/>	<input checked="" type="checkbox"/>	<input checked="" type="checkbox"/>
TRMS	<input checked="" type="checkbox"/>	<input checked="" type="checkbox"/>	<input checked="" type="checkbox"/>
4,000-count display	<input checked="" type="checkbox"/>	<input checked="" type="checkbox"/>	<input checked="" type="checkbox"/>
Max. Hold	<input checked="" type="checkbox"/>	<input checked="" type="checkbox"/>	<input checked="" type="checkbox"/>
CAT IV 600 V	<input checked="" type="checkbox"/>	<input checked="" type="checkbox"/>	<input checked="" type="checkbox"/>



AMMETERS WITH FLEXIBLE CURRENT SENSORS



CONTENTS

- 1 ammeter delivered with:
- 2 x 1.5 V LR06 batteries
- 1 Velcro mounting strap

ACCESSORIES / REPLACEMENT PARTS

- Shoulder bag 120 x 200 x 60 P01298074
- MULTIFIX accessories P01102100Z
- See all the accessories on page 46

MA400D-170 - MAD400D-250

Ref.: P01120575Z

P01120576Z

MA4000D-350

Ref.: P01120577Z

600 V CAT IV	TRMS
-----------------	------

STRENGTHS

- Compact, stand-alone and easy to use
- Direct current readings
- Measurement from just a few tens of mA
- Memorization of maximum value

SPECIFICATIONS

	MA400D-170 / 250		
Display range	4 A _{AC}	40 A _{AC}	400 A _{AC}
Measurement range	0.020 A ... 3.999 A	4.00 A ... 39.99 A	40.0 A ... 399.9 A
Resolution	1 mA	10 mA	100 mA
Accuracy	± (2% + 10 cts)	± (1.5% + 2 cts)	± (1.5% + 2 cts)
Clamping Ø / Sensor length	MA400D-170 : Ø 45 mm / 170 mm MA400D-250 : Ø 70 mm / 250 mm		
Bandwidth	10 Hz ... 3 kHz		
Power supply	2 x 1.5 V LR03 batteries		
Safety	IEC 61010 CAT IV 600 V		
Operating temperature	0°C to +50°C		
Instrument weight	130 g approx.		
Casing dimensions	100 x 60 x 20 mm		
Length of built-in connection cable	0.8 m		

	MA4000D-350		
Display range	40 A _{AC}	400 A _{AC}	4,000 A _{AC}
Measurement range	0.01 A ... 39.99 A	40.0 A ... 399.9 A	400 A ... 3,999 A
Resolution	10 mA	100 mA	1 A
Accuracy	± (2% + 10 cts)	± (1.5% + 2 cts)	± (1.5% + 2 cts)
Clamping Ø / Sensor length	MA4000D-350 : Ø 100 mm / 350 mm		
Bandwidth	10 Hz ... 3 kHz		
Power supply	2 x 1.5 V LR06 batteries		
Safety	IEC 61010 CAT IV 600 V		
Operating temperature	0°C to +50°C		
Instrument weight	130 g approx.		
Casing dimensions	100 x 60 x 20 mm		
Length of built-in connection cable	0.8 m		



CHOOSE YOUR MULTIMETER CLAMP



F201 page 43 **F203** page 43 **F205** page 43 **F401** page 44 **F403** page 44 **F405** page 44 **F407** page 44 **F601** page 45 **F603** page 45 **F605** page 45 **F607** page 45

Clamping \varnothing 34 mm	■	■	■								
Clamping \varnothing 48 mm				■	■	■	■				
Clamping \varnothing 60 mm								■	■	■	■
AC current	■	■	■	■	■	■	■	■	■	■	■
DC current		■	■		■	■	■		■	■	■
Automatic zero DC		■	■		■	■	■		■	■	■
TRMS measurement	■	■	■	■	■	■	■	■	■	■	■
Measurement with DC component (AC+DC)			■			■	■			■	■
Measurement on non-linear loads	■	■	■	■	■	■	■	■	■	■	■
6,000-count display	■	■	■								
10,000-count display				■	■		■ x 3	■	■	■	■ x 3
Backlighting		■	■	■	■	■	■	■	■	■	■
AC and DC voltage measurement	■	■	■	■	■	■	■	■	■	■	■
Resistance	■	■	■	■	■	■	■	■	■	■	■
Audible continuity	■	■	■	■	■	■	■	■	■	■	■
Semi-conductor test	■	■	■	■	■	■	■	■	■	■	■
Frequency	■	■	■	■	■	■	■	■	■	■	■
Temperature	■	■		■	■			■	■		
Active power (W)			■		■	■				■	■
Apparent and reactive power (VA, var)			■		■	■				■	■
Power factor (PF/DPF)			■		■	■	■			■	■
AC / DC / AC+DC power measurement			■		■	■				■	■
Phase rotation (2 wires)			■		■					■	
Total Harmonic Distortion (THDf% / THDr%)			■		■					■	■
Harmonic decomposition (Harm0... Harm25)							■				■
Crest factor (CF)							■				■
Automatic deactivatable AC/DC	■	■	■	■	■	■	■	■	■	■	■
Motor InRush	■	■	■	■	■	■	■	■	■	■	■
Current surge with load (TrueInrush)	■	■	■	■	■	■	■	■	■	■	■
Min.	■	■	■	■	■	■	■	■	■	■	■
Max.	■	■	■	■	■	■	■	■	■	■	■
Peak			■		■	■				■	■
Differential measurement ΔX		■	■		■	■			■	■	
Relative measurement $\Delta X/X$		■	■		■	■			■	■	
Adapter input (external probe)		■			■				■		
Data logging						■					■
PC interface / Bluetooth interface						■					■
CAT IV 600 V	■	■	■								
CAT IV 1000 V				■	■	■	■	■	■	■	■



STRENGTHS

- Clamping \varnothing 34 mm
- Compact format
- Light weight
- TRMS AC+DC with the F205 clamp

CONTENTS

F201 delivered with:

- 1 set of built-in PVC test-probe leads (black/red) / insulated elbowed male banana plug \varnothing 4 mm
- 1 x 9 V 6LR61 battery
- 1 Multifix shoulder bag
- 1 mini-CD containing the User Manual

F203 same as **F201** plus 1 wire thermocouple with built-in insulated \varnothing 4 mm banana connections with 19 mm spacing

F205 delivered with:

- 1 set of PVC leads (black/red) with insulated elbowed male banana plug \varnothing 4 mm / insulated straight male banana plug \varnothing 4 mm
- 2 test probes / insulated female plug \varnothing 4 mm (black/red)
- 1 safety crocodile clip (black)
- 1 x 9 V 6LR61 battery
- 1 Multifix shoulder bag
- 1 mini-CD containing the User Manual

F201 - F203 - F205

Ref.: P01120921 P01120923 P01120925

600 AAC 900 ADC	TRMS	1000 V CAT III	600 V CAT IV	True InRush	IEC 61010-2-032	IEC 61010-2-033
--------------------	------	-------------------	-----------------	----------------	--------------------	--------------------

SPECIFICATIONS

	F201	F203	F205
Clamping		\varnothing 34 mm	
Display	LCD	Backlit LCD	
Resolution	6,000 counts		
Number of values displayed	1		
Type of acquisition	TRMS AC	TRMS AC/DC	TRMS AC, DC, AC+DC
Autorange	Yes		
Automatic AC/DC detection	Yes		
AAC	600 A		
ADC	900 A		
AAC+DC	600 A (900 A peak)		
Best accuracy	1% R + 3 counts		
V _{AC}	1,000 V		
V _{DC}	1,000 V		
V _{AC} +DC	1,000 V (1,400 V peak)		
Best accuracy	1% R + 3 counts		
Frequency for V / I	Yes / Yes		
Resistance	60 k Ω		
Audible continuity	Adjustable from 1 Ω to 599 Ω		
Diode test (semi-conductor junction)	Yes		
Temperature (type K)	°C: -60.0 to +1,000 °C °F: -76 to +1,832 °F		
Adapter	Yes		
Single-phase and total three-phase power values	AC, DC, AC+DC		
Active (W)	Yes		
Reactive (var)	Yes		
Apparent (VA)	Yes		
FP	Yes		
Harmonic analysis THDf / THDr	Yes / Yes		
Phase rotation (2-wire method)	Yes		
Functions			
Overcurrent measurement	Yes		
Motor InRush	Yes		
Load evolution (TrueInrush)	Yes		
Hold	Yes		
Min / MAX	Yes		
Peak+ / Peak-	Yes		
RELative Δ X Differential Δ X/X(%)	Yes	Yes	Yes
Auto Power Off	Yes		
Electrical safety as per IEC 61010-1, IEC 61010-2-032, IEC 61010-2-033	600 V CAT IV - 1000 V CAT III		
Power supply	1 x 9 V 6LR61 battery		
Dimensions / weight	78 x 222 x 42 mm / 340 g		



MULTIMETER CLAMPS



F401 - F403 - F405 - F407

Ref.: P01120941 P01120943 P01120945 P01120947

1000 AAC 1500 Aoc	TRMS	1000 V CAT IV	IP 54	True InRush	IEC 61010-2-032	IEC 61010-2-033
----------------------	------	------------------	----------	----------------	--------------------	--------------------

SPECIFICATIONS

	F401	F403	F405	F407
Clamping	Ø 48 mm			
Display	Backlit LCD			
Resolution	10,000 counts			
Number of values displayed	1			3
Type of acquisition	TRMS AC	TRMS AC/DC	TRMS AC, DC, AC+DC	
Autorange	Yes			
Automatic AC/DC detection	Yes			
AAC	1,000 A			
ADc	1,500 A			
AAC+DC	1,000 A (1,500 A peak)			
Best accuracy	1% R + 3 counts			
VAC	1,000 V			
VDC	1,000 V			
VAC+DC	1,000 V (1,400 V peak)			
Best accuracy	1% R + 3 counts			
Frequency for V / I	Yes / Yes			
Resistance	100 kΩ			
Audible continuity	Adjustable from 1 Ω to 999 Ω			
Diode test (semi-conductor junction)	Yes			
Temperature (type K)	°C: -60.0 to +1,000 °C °F: -76 to +1,832 °F			
Adapter	Yes			
Single-phase and total three-phase power values				Yes
Active (W) Reactive (VAR) Apparent (VA)				Yes Yes Yes
FP / DPF	Yes / -			Yes / Yes
Harmonic analysis	THDf / THDr			Yes / Yes
Frequency analysis	No			25th order
Phase rotation (2-wire method)	Yes			
Functions				
Overcurrent measurement	Yes			
Motor Inrush	Yes			
Load evolution (Truelnrush)	Yes			
Hold	Yes			
Min / MAX	Yes			
Peak+ / Peak-				Yes
RELative ΔX Differential ΔX/X(%)	Yes Yes	Yes Yes		
Auto Power Off	Yes			
Data logging				Yes
Communication interface				Bluetooth
Electrical safety as per IEC 61010-1, IEC 61010-2-032, IEC 61010-2-033	1000 V CAT IV - 1000 V CAT III			
Power supply	4 x 1.5 V LR06 batteries			
Dimensions / weight	92 x 272 x 41 mm / 600 g			

STRENGTHS

- Small and medium-power LV applications
- Clamping Ø 48 mm
- TRMS AC+DC with the F405 / F407 clamps
- Delivered in pre-equipped MultiFix shoulder bag

CONTENTS

F401 / F403 delivered with:

- 1 set of PVC leads (black/red) with insulated elbowed male banana plug Ø 4 mm / insulated straight male banana plug Ø 4 mm
- 2 test probes / insulated female plug Ø 4 mm (black/red)
- 1 wire thermocouple with built-in insulated Ø 4 mm banana connections with 19 mm spacing
- 4 x 1.5 V LR03 batteries
- 1 Multifix shoulder bag
- 1 mini-CD containing the User Manual

F405 same as F401 / F403 without the wire thermocouple and with 1 safety crocodile clip (black)

F407 same as F405 with:

- 2 safety crocodile clips (red/black)
- 1 mini-CD containing the Power Analyser Transfer PC software and the User Manual



STRENGTHS

- High-power LV applications
- Clamping \varnothing 60 mm
- TRMS AC+DC with the F605 / F607
- Delivered in pre-equipped MultiFix shoulder bag

CONTENTS

F601 / F603 delivered with:

- 1 set of PVC leads (black/red) with insulated elbowed male banana plug \varnothing 4 mm / insulated straight male banana plug \varnothing 4 mm
- 2 test probes / insulated female plug \varnothing 4 mm (black/red)
- 1 wire thermocouple with built-in insulated \varnothing 4 mm banana connections with 19 mm spacing
- 4 x 1.5 V LR03 batteries
- 1 Multifix shoulder bag
- 1 mini-CD containing the USER Manual

F605 same as F601/F603 without the wire thermocouple and with 1 safety crocodile clip (black)

F607 same as F605 with:

- 2 safety crocodile clips (black/red)
- 1 mini-CD containing the Power Analyser Transfer PC software and the User Manual

F601 - F603 - F605 - F607

Ref.: P01120961 P01120963 P01120965 P01120967

2000 Aac 3000 Aac	TRMS	1000 V CAT IV	IP 54	True InRush	IEC 61010-2-032	IEC 61010-2-033
----------------------	------	------------------	----------	----------------	--------------------	--------------------

SPECIFICATIONS

	F601	F603	F605	F607
Clamping	\varnothing 60 mm			
Display	Backlit LCD			
Resolution	10,000 counts			
Number of values displayed	1			3
Type of acquisition	TRMS AC	TRMS AC/DC	TRMS AC, DC, AC+DC	
Autorange	Yes			
Automatic AC/DC detection	Yes			
Aac	2,000 A			
Aac	3,000 A			
AAC+DC	2,000 A (3,000 A peak)			
Best accuracy	1% R + 3 counts			
Vac	1,000 V			
Vdc	1,000 V			
VAC+DC	1,000 V (1,400 V peak)			
Best accuracy	1% R + 3 counts			
Frequency for V / I	Yes / Yes			
Resistance	100 k Ω			
Audible continuity	Adjustable from 1 Ω to 999 Ω			
Diode test (semi-conductor junction)	Yes			
Temperature (type K)	°C: -60.0 to +1,000 °C °F: -76 to +1,832 °F			
Adapter	Yes			
Single-phase and total three-phase power values	Yes			
Active (W) Reactive (VAR) Apparent (VA)	Yes Yes Yes			
FP / DPF	Yes / -		Yes / Yes	
Harmonic analysis THDf / THDr	Yes / Yes			
Frequency analysis	25th order			
Phase rotation (2-wire method)	Yes			
Functions				
Overcurrent measurement	Yes			
Motor Inrush	Yes			
Load evolution (Truelnrush)	Yes			
Hold	Yes			
Min / MAX	Yes			
Peak+ / Peak-	Yes			
RELative Δ X Differential Δ X/X(%)	Yes Yes		Yes Yes	
Auto Power Off	Yes			
Data logging	Yes			
Communication interface	Bluetooth			
Electrical safety as per IEC 61010-1, IEC 61010-2-032, IEC 61010-2-033	1000 V CAT IV - 1000 V CAT III			
Power supply	4 x 1.5 V LR06 batteries			
Dimensions / weight	111 x 296 x 41 mm / 640 g			



TESTERS

C.A 732

- 1.5 V LR03 battery P01296032

C.A 745N

- Set of red/black CAT III/IV test probes P01102152Z
- Set of red/black test probes - Ø 2 mm, CAT II P01102153Z
- Set of red/black test probes - Ø 4 mm, CAT II P01102154Z
- C.A 753 universal measurement adapter for 2P+E sockets P01191748Z
- Velcro strap x 5 P01102113
- 1.5 V LR03 alkaline battery P01296033
- Bag compatible with MultiFix accessory, 120 x 200 x 60 mm P01298074
- MultiFix mounting accessory P01102100Z

C.A 755, C.A 757

- Set of black/red CAT III/IV test probes P01102152Z
- Set of black/red Ø 2 mm test probes, CAT II P01102153Z
- Set of black/red Ø 4 mm test probes, CAT II P01102154Z
- MA101-250 current sensor for C.A 757 P01120591
- C.A 753 universal measurement adapter for 2P+E sockets P01191748Z
- Velcro strap x 5 P01102113
- 1.5 V LR03 alkaline battery P01296033
- Bag compatible with MultiFix accessory, 120 x 200 x 60 mm P01298074
- MultiFix mounting accessory P01102100Z

VOLTAGE DETECTORS

C.A 742, C.A 742 IP2X, C.A 762 and C.A 762 IP2X

- Measurement adapter for 2P+E socket, model C.A 751 P01101997Z
- Universal measurement adapter for 2P+E socket, model C.A 753 P01191748Z
- Red test probe Ø2 mm P01102008Z
- Black test-probe lead Ø2 mm P01102009Z
- Adapter for safety rod (set of 2) P01102034
- Crystal safety cap for test probe Ø2 mm (x10) P01102033
- Set of 2 leads 0.25 m and 0.85 m long with Ø4 mm IP2X test probes P01295285Z
- Set of 2 leads 1.5 m long with Ø4 mm IP2X test probes P01295462Z
- MultiFix shoulder bag, 120 x 200 x 60 mm P01298074
- IP2X CAT IV test probes P01102127Z
- IP2X Ø4 mm test probes P01102128Z
- Soft case, 200 x 100 x 40 mm with belt clip P01298065Z
- Shoulder bag no. 10 P01298012Z
- Wrist-strap P03100824
- 1 probe-holder cable 1.10 m long + 2 red/black Ø 4 mm IP2X test probes P01102121Z

C.A 771, C.A 771 IP2X, C.A 773 and C.A 773 IP2X

- CAT IV test probes P01102123Z
- Ø2 mm test probes P01102124Z
- Ø4 mm test probes P01102125Z
- Test-probe protector P01102126Z
- IP2X CAT IV test probes P01102127Z
- IP2X Ø4 mm test probes P01102128Z
- MultiFix shoulder bag, 120x320x60 mm P01298076
- Crystal safety cap for test probe Ø2 mm (x10) P01102033

ANALOGUE MULTIMETERS

C.A 5001, C.A 5003 and C.A 5005

- Accessories kit for electricians P01295459Z
- I/R probe P01651610Z
- C.A 801 single-channel temperature adapter P01652401Z
- C.A 803 two-channel temperature adapter with differential measurement P01652411Z
- CMI214S current measurement lead P03295509
- Shoulder bag P01298033
- Soft case no. 5 P01298036
- Hard case P01298037
- Shoulder bag no. 21 with strap (250x165x60 mm) P06239502
- 1 probe-holder cable 1.10 m long + 2 red/black Ø 4 mm IP2X test probes P01102121Z

C.A 5001

- 1.5 V LR06 battery P01296033
- 0.5 A HRC fuse (x 10) P01297028
- 5 A HRC fuse (x 10) P01297035

C.A 5003

- 9 V 6LR61 battery P01100620
- MN11 LCA 200/0.2 clamp P01120404
- 1.6 A HRC fuse (x 10) P01297036
- 16 A HRC fuse (x 10) P01297037

C.A 5005

- 9 V 6LR61 battery P01100620
- MINI 09 clamp - 1 A / 100 MVDC P01105109Z
- MN11 LCA 200/0.2 clamp P01120404
- 10 A HRC fuse (x 10) P01297038
- 1 A HRC fuse (x 10) P01297039



ACCESSORIES / REPLACEMENT PARTS

C.A 5011

■ 9 V 6LR61 battery	P01100620
■ Crocodile wire grip (x 2)	P01102053Z
■ Insulation-piercing clip (x 2)	P01102055Z
■ Moulded PVC lead with straight male plug/insulated elbowed male plug Ø4 mm (x 2)	P01295451Z
■ Moulded red/black silicone lead with straight male plug/insulated elbowed male plug Ø4 mm (x 2)	P01295453Z
■ Safety test probe (x 2)	P01295454Z
■ PVC test-probe lead, insulated elbowed male plug Ø 4 mm (x 2)	P01295456Z
■ Crocodile clip (x 2)	P01295457Z
■ Ø 4 mm CAT II 300 V test probe (x 2)	P01295458Z
■ Ø 2 mm CAT II 300 V test probe (x 2)	P01295460Z
■ IP2X test-probe lead (x 2)	P01295461Z
■ Accessories kit for electricians	P01295459Z
■ I/R probe	P01651610Z
■ C.A 801 single-channel temperature adapter	P01652401Z
■ C.A 803 two-channel temperature adapter with differential measurement	P01652411Z
■ CMI214S current measurement lead	P03295509

DIGITAL MULTIMETERS**C.A 5231, C.A 5233, C.A 5271, C.A 5273, C.A 5275 et C.A 5277**

■ 9 V 6LR61 battery	P01100620
■ Crocodile wire grips (x 2)	P01102053Z
■ Insulation-piercing clip (x 2)	P01102055Z
■ 40 kVdc / 28 kVac high-voltage probe	P01102097
■ MultiFix multi-position mounting accessory	P01102100Z
■ Moulded PVC lead with straight male plug/insulated elbowed male plug Ø4 mm (x 2)	P01295451Z
■ Moulded red/black silicone lead with straight male plug/insulated elbowed male plug Ø4 mm (x 2)	P01295453Z
■ Safety test probe (x 2)	P01295454Z
■ PVC test-probe lead, insulated elbowed male plug (x 2)	P01295456Z
■ Crocodile clip (x 2)	P01295457Z
■ Ø 4 mm CAT II 300 V test probe (x 2)	P01295458Z
■ Ø 2 mm CAT II 300 V test probe (x 2)	P01295460Z
■ IP2X test-probe lead (x 2)	P01295461Z
■ Accessories kit for electricians	P01295459Z
■ I/R probe	P01651610Z
■ C.A 801 single-channel temperature adapter	P01652401Z
■ C.A 803 two-channel temperature adapter with differential measurement	P01652411Z

C.A 5231

■ 100 AAC MINI 03 current clamp	P01105103Z
■ 400 AAC / 600 ADC PAC10 current clamp	P01120070

C.A 5233, C.A 5273 and C.A 5277

■ Safety thermocouple adapter (x 2)	P01102106Z
■ Safety adapter and temperature probe, wire K sensor, -50°C to +450°C	P01102107Z
■ CMI214S current measurement lead	P03295509



MULTIMETER CLAMPS

F200, F400 and F600 SERIES

- MultiFix multi-position mounting accessory P01102100Z
- Moulded PVC lead with straight male plug/insulated elbowed male plug $\varnothing 4$ mm (x 2) P01295451Z
- Moulded red/black silicone lead with straight male plug/insulated elbowed male plug $\varnothing 4$ mm (x 2) P01295453Z
- Safety test probe (x 2) P01295454Z
- PVC test-probe lead, insulated straight male plug $\varnothing 4$ mm (x 2) P01295455Z
- PVC test-probe lead, insulated elbowed male plug $\varnothing 4$ mm (x 2) P01295456Z
- Crocodile clip (x 2) P01295457Z
- $\varnothing 4$ mm CAT II 300 V test probe (x 2) P01295458Z
- IP2X test-probe lead (x 2) P01295461Z
- Accessories kit for electricians P01295459Z
- CMI214S current measurement lead P03295509

F400 and F600 SERIES

- 1.5 V LR06 battery P01296033
- MultiFix shoulder bag 120x320x60 mm P01298076

F201 and F205

- 9 V 6LR61 battery P01100620
- MultiFix shoulder bag 120x245x60 mm P01298075

F203

- 9 V 6LR61 battery P01100620
- Safety thermocouple adapter (x 2) P01102106Z
- Safety adapter and temperature probe, wire K sensor, -50°C to $+450^{\circ}\text{C}$ P01102107Z
- MultiFix shoulder bag 120x245x60 mm P01298075
- C.A 801 single-channel temperature adapter P01652401Z
- C.A 803 two-channel temperature adapter with differential measurement P01652411Z

F403 and F603

- Safety thermocouple adapter (x 2) P01102106Z
- Safety adapter and temperature probe, wire K sensor, -50°C to $+450^{\circ}\text{C}$ P01102107Z
- C.A 801 single-channel temperature adapter P01652401Z
- C.A 803 two-channel temperature adapter with differential measurement P01652411Z

F407 and F607

- DataView[®] software P01102095
- Bluetooth/USB modem P01102112

MA400D & MA4000D

- Shoulder bag 120x200x60 mm P01298074
- MultiFix accessories P01102100Z
- Velcro strap (set of 5) P01102113

FIND ALL OUR ACCESSORIES ON PAGE 230

ELECTRICAL SAFETY

Info and advice	52
Installation testers	62
Insulation testers	66
Multimeter clamps for leakage current	77
Earth and resistivity testers	79
Electrical equipment testers	87
Other testers	91
Data processing software	100
Accessories	102



ELECTRICAL INSTALLATION TESTING

The risks linked to incorrect use of electricity may include:

- life-threatening danger for people,
- threat of damage to electrical installations and property,
- harmful effects on systems operation and equipment life spans.

So the purpose of electrical installation testing is primarily to ensure that people and goods are kept safe and are protected in the event of a fault. It also facilitates preventive maintenance of installations, preventing serious faults which might prove expensive (production shutdown, etc.).

To guarantee people's safety with regard to these installations and the electrical equipment connected to them, standards have naturally been developed and updated to take changes into account. The IEC 60364 standard and its various national equivalents published in each European country, such as NF C 15-100 in France or VDE 100 in Germany, specify the requirements concerning electrical installations in buildings. Chapter 6 of this standard describes the requirements for testing the compliance of an installation.

1. EARTH

To guarantee safety on residential or industrial electrical installations, one of the basic rules is that there must be an earth electrode.

If there is no earth electrode, it may endanger people's lives and damage electrical installations and property.

When a large enough area is available to set up stakes, you should measure the earth with the traditional 3-pole method, also known as the 62 % method.

2. CONTINUITY

The purpose of continuity measurement is to check the continuity of the protective conductors and the main and supplementary equipotential bonds. The test is carried out using a measuring instrument capable of generating a no-load voltage of 4 to 24 V (DC or AC) with a minimal current of 200 mA. The resistance measured must be lower than a threshold specified by the standard applicable to the installation tested, which is usually 2 Ω . As the resistance value is low, the resistance of the measurement leads must be compensated, particularly if very long leads are used.

The effectiveness of the safety measures implemented can only be guaranteed if regular tests prove they are operating correctly. This is why the standards cover not only the initial verifications when installations are commissioned, but also periodic testing whose frequency depends on the type of installation and equipment, its use and the legislation in the country involved. In addition, the tests must be carried out with measurement instruments that comply with the IEC 61-557 European standard ensuring user safety and reliable measurements. The electrical testing is divided into 2 parts:

1. Visual inspection to guarantee that the installation complies with the safety requirements (presence of an earth electrode, protective devices, etc.) and does not show any visible evidence of damage.

2. Measurements

There are 4 main measurements required:

1. Earth
2. Continuity
3. Insulation
4. Tests of protective devices

When the 62 % method is not applicable, however, other methods can be used. There are many methods for measuring the earth (1P live earth, PH-PE loop impedance, selective earth with 1-clamp method, etc.), some more suitable than others, depending on the type of earth connection system, the type of installation (residential, industrial, urban, rural, etc.), the possibility of cutting off the power, the area available for planting stakes, etc.

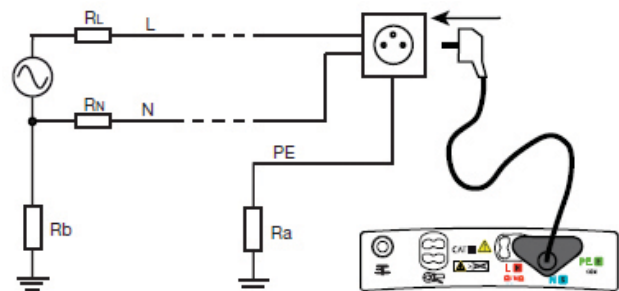

Example : Approximate measurement of earth resistance by the Zs (Ph-PE) loop impedance measurement method in a TT-type earthing system



3. INSULATION

Good insulation is **essential to prevent electric shocks**. This measurement, usually carried out between active conductors and the earth, involves injecting a DC voltage, measuring the current and thus determining the insulation resistance value.

The power must be switched off and the installation must be disconnected before performing this test to ensure that the test voltage will not be applied to other equipment electrically connected to the circuit to be tested, particularly devices sensitive to voltage surges.

According to the IEC 60364 standard, the minimum insulation resistance values must be as follows:

Rated voltage of circuit V	DC test voltage V	Insulation resistance MΩ
SELV or PELV	250	≥ 0.5
≤ 500 V including PELV	500	≥ 1.0
> 500 V	1,000	≥ 1.0

4. TESTS OF PROTECTIVE DEVICES

Fuses / Circuit-breakers

To check the specifications of the protective devices such as fuses or circuit-breakers, **a fault loop impedance measurement is carried out** to calculate the corresponding short-circuit current. A visual inspection can then be used to check that the sizing is correct.

A fuse table directly integrated in certain installation testers can be used to check automatically that the fuses are correctly sized.

Residual Current Devices (RCDs): types AC, A and B

RCDs, which detect earth leakage currents, can be tested using two methods:

- the basic test, also called a pulse test, which determines the trip time (in milliseconds)
- the step test, which determines the trip time and trip current, thus detecting any RCD ageing.

Type-B RCDs are designed to provide a specified response for DC-only leakage currents. A specific test is then required to check RCDs of this type.

5. OTHER RECOMMENDED MEASUREMENTS

When testing low-voltage installations, other measurements are recommended (mandatory in some countries) such as:

- **The voltage drop $\Delta V\%$ in the cables**, obtained by means of two line-impedance measurements to check that their cross-sections are appropriate
- **The correct phase order** in three-phase systems, thus ensuring that rotating machines turn in the right direction
- **The installation's voltage and frequency**, allowing identification of any poor connections

Detection of phase current unbalance by measuring with a clamp and first-level assessment of the harmonic content are useful additions to any installation analysis.

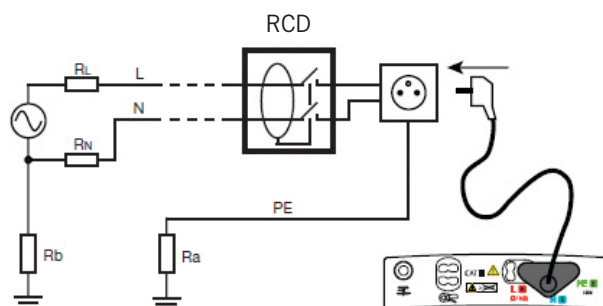

Example: RCD test via connection in a wall socket in TT-type earthing systems.



INSULATION MEASUREMENT

To ensure that electrical equipment and installation operate correctly in total safety, all the conductors are insulated: sheathing for cables, varnish for windings. When the quality of these insulating materials diminishes, leakage currents may flow from one conductor to the other and, depending on the extent of the insulation faults (the worst being a short-circuit), may cause serious damage.

Equipment with faulty insulation may break down, burn or cause a fault on the installation itself, thus triggering protective devices and shutting down the whole installation...

Furthermore, some particularly sensitive installations (operating theatres in hospitals, chemical industries, etc.) are built using an IT-type earthing system (cf. IEC 60364-6), which tolerates an initial line-earth insulation fault and only shuts down the installation if a second fault occurs.

Measurements are needed to prevent and prepare for the hazards linked to insufficient or damaged insulation. These measurements concern both the electrical equipment and the installations to which it is connected.

These measurements are carried out during commissioning on new or reconditioned items, and **then repeated regularly** to monitor their evolution over time.

INSULATION RESISTANCE MEASUREMENT AND DIELECTRIC TESTING

These two concepts, which characterize the quality of an insulant, require further explanation as they are too frequently confused.

■ **Dielectric strength testing**, also called “breakdown testing”, **measures an insulant’s ability to withstand a medium-duration voltage surge without sparkover occurring**. In reality, this voltage surge may be due to lightning or the induction caused by a fault on a power transmission line. The main purpose of this test is to ensure that the construction rules concerning leakage paths and clearances have been respected. This test is often performed by applying an AC voltage but can also be done with a DC voltage. This type of measurement requires a dielectrometer.

The result obtained is a voltage value usually expressed in kilovolts (kV). Dielectric testing may be destructive in the event of a fault, depending on the test levels and the available energy in the instrument.

For this reason, it is reserved for type tests on new or

reconditioned equipment: only equipment that passes the test will be put into service.

■ **Insulation resistance measurement**, however, is non-destructive under normal test conditions. Carried out by applying a DC voltage with a smaller amplitude than for dielectric testing, it yields a result **expressed in k Ω , M Ω or G Ω** . This resistance indicates **the quality of the insulation between two conductors** and provides a good idea of the risks of leakage currents. Because it is non-destructive, it is particularly useful for monitoring insulant ageing during the operating life of electrical equipment or installations. This means it can be used as a **basis for preventive maintenance**. This measurement is performed using an insulation tester, also called a megohmmeter.

MEASURING LEVELS OF INSULATION

In concrete terms, first of all the installation or equipment is checked to ensure that no voltage is present in it. Then a DC test voltage is applied and the insulation resistance value is read. **When measuring an insulation in relation to the earth, you are advised to place the positive pole of the test voltage on the earth** to prevent earth polarization problems when carrying out multiple tests.

All the standards concerning electrical installations or equipment specify the measurement conditions and minimum thresholds to be respected for insulation measurements.



INSULATION MEASUREMENT APPLICATIONS

Insulation measurement on electrical installations

Insulation test before powering up

Before powering up a new installation, its insulation must be tested.

Two types of measurements are required:

- **Verification of the conductors:** this checks that none of the conductors, cut-off devices or connection equipment has suffered damage liable to cause an insulation fault. This is done before commissioning the installation, with all the receivers disconnected.
- **Verification of the whole installation** in relation to the earth.

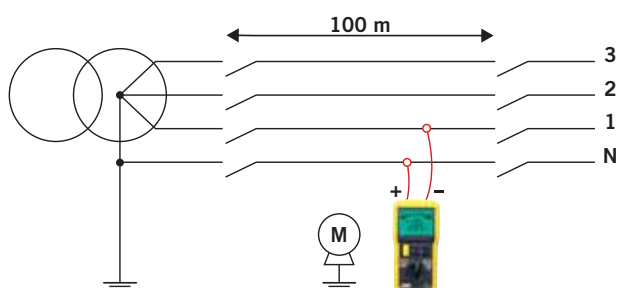

Insulation test after powering up

After powering up the installation, **the insulation should be checked regularly** to make sure there is no substantial drift away from the initial values.

Because the method used is the same as for testing before powering up, the installations must be switched off.

In both cases, the insulation will be considered acceptable if the insulation resistance measured is greater than the threshold specified by the applicable standard for the installation tested (NF C 15-100 in France, VDE 100 in Germany, European standard IEC 60364, IEEE 43-2000, etc.)

Insulation measurement on motors, transformers, etc.

Whether on electrical installations or on machines, **the quality of the insulating materials deteriorates as time passes** due to the stresses affecting the equipment. This deterioration reduces the electrical resistivity of the insulants, leading in turn to an increase in the leakage currents and causing incidents which may be serious in terms of the safety of people and property, but also in terms of production stoppage costs in industry.

So, in addition to the measurements during commissioning of new or renovated equipment, **regular insulation testing of installations and equipment helps to prevent such**

incidents by organizing **preventive maintenance** designed to detect ageing and therefore prevent premature deterioration of the insulation properties before they reach a level liable to cause the incidents described above.

Deterioration of the equipment may occur naturally, but it is often also accelerated by external contaminants such as dust, oil, etc. It is therefore strongly recommended to monitor its insulation over time.

To carry out this preventive maintenance effectively, the **Chauvin Arnoux range of megohmmeters** proposes the following functions:

- PI, DAR and DD quality ratios for a quick assessment of insulation quality, with the added advantage that they are not particularly influenced by temperature, making them easy to use without requiring correction of the results
- Automatic calculation of the insulation resistance at a reference temperature (C.A 6549, C.A 6550, C.A 6555)
- Method based on the influence of test voltage variation (step voltage measurement)

CRITERIA FOR CHOOSING AN INSULATION TESTER

Here are a few tips to help you choose an insulation tester that matches your requirements.

■ The application.

What type of equipment will you be testing: electrical installations, switchgear, telephony, etc.

Rated operating voltage, manufacturer recommendations, dedicated standards

Test voltage: 50 – 100 – 250 – 500 – 1,000 – 2,500 – 5,000 – 10,000 – 15,000 VDC

Measurement range: kΩ, MΩ, GΩ, TΩ

■ User comfort.

Reading mode: needle display with logarithmic scale, digital LCD, analogue bargraph

User-friendly features: programmable alarm thresholds, backlighting, remote control probe

■ Operating mode.

Hand-cranked generator, normal or rechargeable batteries
Other measurements required: continuity, current, voltage, etc.

Single-function or multi-function instrument, for testing installations or machines



EARTH MEASUREMENT

For residential or industrial installations, the presence of an earth connection is one of the basic rules to ensure that the electrical installation is safe.

The absence of an earth connection may endanger people's lives and damage electrical installations and property.

However, the presence of an earth connection does not guarantee safety and, even if the earth is correctly sized, only regular testing can ensure that it functions correctly.

The standards for electrical installations, such as IEC 60364, NF C 15-100, etc., stipulate the general installation conditions to be applied in order to guarantee the safety of people, pets,

farm animals and property by protecting them against the hazards and damage which may result from use of the electrical installations.

When there is a large enough area available to set up stakes, earth measurement should be carried out with the traditional 3-pole method, also known as the 62 % method.

There are a large number of different methods for earth measurements, however, and the right choice depends on the type of earthing system, the type of installation (residential, industrial, urban, rural, etc.), the possibility of switching off the power supply, the area available for setting up stakes, etc.

LIST OF THE DIFFERENT EARTH MEASUREMENT METHODS

	Rural building with possibility of setting up stakes	Urban building with no possibility of setting up stakes
Single earth connection		
3-pole method alias 62 % method	■	
Triangle method (2 stakes)	■	
4-pole method	■	
Variant 62 % method (1 stake)	■	
Line-PE loop measurement	■	Only with TT system
Network of multiple parallel earths		
Selective 4-pole method	■	
Earth clamp	■	■
Earth loop measurement with 2 clamps	■	■

Here is an overview of the most frequently-used measurement methods:

The 62 % in-line measurement method (two stakes)

This method requires the use of two auxiliary electrodes (or "stakes") to allow current injection and provide the 0 V reference potential.

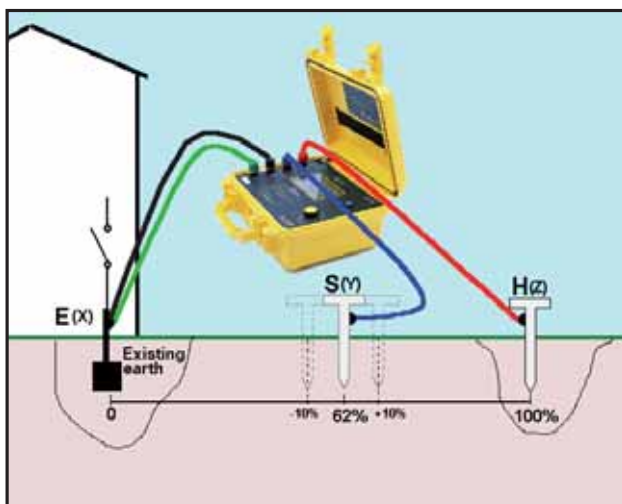

The positioning of the two auxiliary electrodes in relation to the earth connection to be tested E(X), is crucial. For correct measurements, the "auxiliary connection" providing the reference potential (S) must not be positioned in the areas influenced by earths E & H due to the flow of the current (i).

Statistics from the field have shown that the ideal method for guaranteeing the highest possible measurement accuracy involves placing the stake S at a point 62 % of the distance from E on the line EH.

You must then make sure that the measurement does not vary significantly when moving the stake S by $\pm 10\%$ (S' and S'') on either side of its initial position, while remaining on the line EH.

If the measurement varies, it means that (S) is in an influence area, so the procedure should be repeated after increasing the distances.

For a correct measurement, the stake H should be at least 25 metres away from the earth to be tested.

For more accurate measurement, it is possible to use



a 4-pole measurement method (adding a connection between the earth to be tested and the ES terminal of the measurement instruments) to minimize the resistance of the measurement leads, thus improving accuracy. This method is strongly recommended for low resistance values as the influence of measurement-lead resistance will then be considerable.

Line-PE loop measurement (only on TT system)

In urban environments, it often proves difficult to measure earth resistances using auxiliary stakes because it is not possible to set up the stakes for reasons of space, concreting, etc.

Loop measurement can then be used to test earths in urban environments without using stakes simply by hooking up to the mains power supply (mains socket).

In addition to the earth to be measured, the loop resistance measured in this way includes the earth and internal resistance of the transformer and the resistance of the cables. As all these resistances are very low, the value measured is an overall earth resistance value.

The actual earth resistance is therefore lower: $R_{\text{measured}} > R_{\text{earth}}$. The (overall) measurement error introduced by this method actually contributes to greater safety. The standards concerning electrical installations consider that the loop resistance (overall earth resistance) may be taken into account instead of the earth resistance to comply with the rules on protection against the risk of indirect contacts.

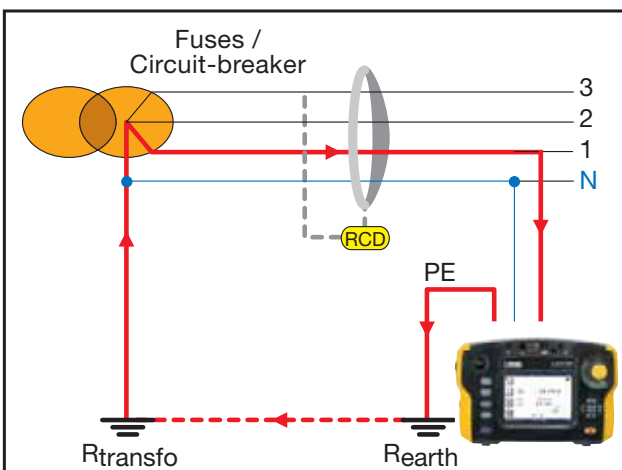

Note: on TN or IT (impedant) systems, the loop impedance measurement can be used to calculate the short-circuit current and thus to size the protective devices correctly.

Selective earth measurements

For interconnected earths, selective earth measurement can be used for quick, safe testing. In this case, it is not necessary to isolate the installation (no need to open the

earth bar) and, for loop measurements with 2 clamps or **with an earth clamp, it is not necessary to set up stakes.**

For the earth clamp and for the 2-clamp method, all you have to do to find out the earth value and the value of the currents flowing in it is clamp the cable connected to the earth.

An earth clamp comprises two windings: a generator winding and a receiver winding:

- The clamp's "generator" winding develops an AC voltage at the constant level E around the clamped conductor; a current $I = E / R_{\text{loop}}$ then flows through the resistive loop.
- The "receiver" winding measures this current.
- As E and I are known values, the loop resistance can be deduced from them.

This case involves a network of parallel earths. Knowing that "n" resistances in parallel are equivalent to a resistance R_{aux} with a negligible value, we can measure the local earth value R_x :

$R_{\text{loop}} = R_x + R_{\text{aux}}$ (where R_{aux} = resistance equivalent to $R_1 \dots R_n$ in parallel)

As $R_x \gg R_{\text{aux}}$, we obtain the result $R_{\text{loop}} \approx R_x$

The 2-clamp method is an equivalent method. One clamp acts as the generator, while the second acts as the receiver. This method may be more practical in places where access is difficult or when a larger clamping diameter is required.

Schematic diagram: earth clamp

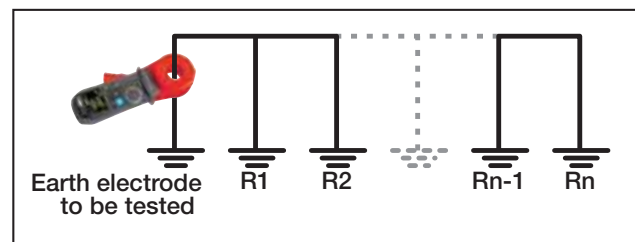

Schematic diagram: 2-clamp method

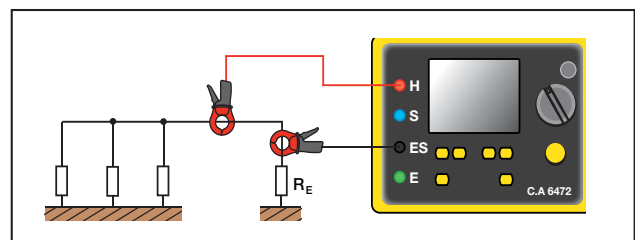

It is also possible to use the 4-pole + clamp method, which requires auxiliary stakes but allows precise measurement of the earth resistance.



SAFETY OF MACHINES, SWITCHBOARDS AND PORTABLE ELECTRICAL APPLIANCES

MACHINE SAFETY

The IEC 60204 / EN 60204 standard defines a **machine** as a **set of parts** or systems linked together, **at least one of which is mobile**. The fields of application are particularly diverse: machines for working metal, wood, textiles, printing, compressors, leather, tanneries, agricultural machinery, building sites and quarries, etc.

Part 1 of this reference standard defines the general requirements regarding electrical machine safety to ensure the protection of people who may be exposed to hazardous phenomena due to failure of the electrical equipment or the command circuits, disturbances in the power sources or power circuits, loss of continuity in the circuits, electromagnetic disturbances, release of accumulated energy, excessive audible noise or excessive surface temperatures.

To ensure electrical safety on the machines, you have to carry out a number of checks and tests after initial implementation, installation, renovation or modification and during periodic testing

- Checking of the **protective automatic cut-off systems** on the power supply in particular (the types of tests and checks depend on the earthing system):
 - Checking of PE continuity on each circuit in the machine with a measurement current ≥ 200 mA which may be as high as 10 A,

SWITCHBOARD SAFETY

The IEC 61439 / EN 61439 standard defines a set of low-voltage equipment as a combination of one or more low-voltage connection devices.

A recent upgrade of this standard precisely defines the limits of liability between the original manufacturer, who should perform the design checks, and the assembler (switchboard operator) who should perform individual series testing. These checks include construction and performance tests. The switchboard operator is considered to become the original manufacturer if modifications are made to the low-voltage switchboard. A declaration of conformity based on simple comparison with a similar switchboard will not be accepted, so a new check is

- Verification of the loop impedance as per IEC 61557-3 and correct coordination of the protection against overcurrents
- Visual check of the protection against overcurrents
- RCD testing as per IEC 61557-6, tripping-time test (recommended)
- Verification of the current at the first insulation fault by measurement or calculation

Note: this test may be simplified depending on the condition of the machine as established by a questionnaire included in the standard.

- Insulation resistance measurement at 500 VDC, $R > 1$ M Ω
- Test of dielectric strength with 50 or 60 Hz AC voltage, at $2 \times UN$ or 1,000 V, duration 1 sec (without disruptive discharge)
- Residual overvoltage test by measuring the discharge time < 1 sec or 5 sec.
- Operating test of the machine and the circuits involved in electrical safety
- The tests are usually performed in the order of decreasing failure in order to intercept electrical safety problems on the machine tested as quickly as possible.

Other aspects of the machine may be checked, such as the conformity of the documentation, the temperature reached, the correct order of the phase sequence and the phase drop between the power supply and the load.

necessary. This new context means that additional test equipment is needed to ensure compliance with the requirements of this reference standard.

The tests required for low-voltage switchboards are:

- **Physical measurement of the insulation gap or leakage distance**
- **PE continuity check** with a measurement current ≥ 200 mA which may be up to 10 A ($R \leq 0.1$ Ω)
- **Short-circuit withstand** by creating a bolted short-circuit
- Checking of the **dielectric properties** by a test at 50 / 60 Hz with the application of a voltage between the different groups of terminals rising slowly and then held for 5 sec or 1 sec



■ **Insulation test** (variant)

Other aspects can also be checked, such as the discharge time, the IP protection rating, the electrical circuits and

connections (by random testing), identification of the external terminals, mechanical operation, shock voltage withstand, heating, etc.

SAFETY OF PORTABLE ELECTRICAL APPLIANCES

The VDE 701 and VDE 702 standards define the inspections to be performed after repair or modification of the electrical appliances and the periodic inspections necessary, as well as general guidelines for electrical safety. This reference standard describes the automatic sequencing of the tests to be performed.

Many of the tests and checks to be performed are identical to those described in the Machines and Switchboards

section, plus certain tests “with probes” when the equipment does not have double insulation or reinforced insulation (Class I).

Furthermore, the leakage current measurements must include leakage measurements by different methods (substitution method, differential leakage method, contact leakage method, etc.). The polarity of the mains leads must also be checked to ensure that it complies.

MAIN TESTS & CHECKS

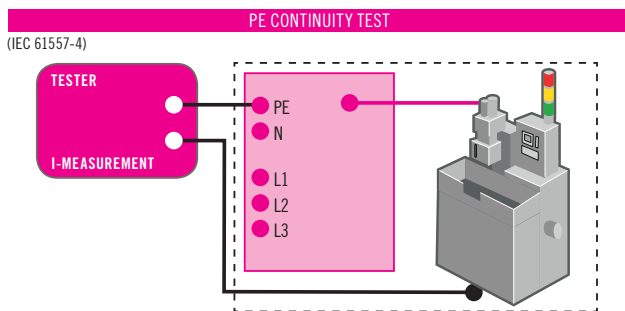

Used to check whether the resistance measured corresponds to the cross-section and length of the PE conductor.

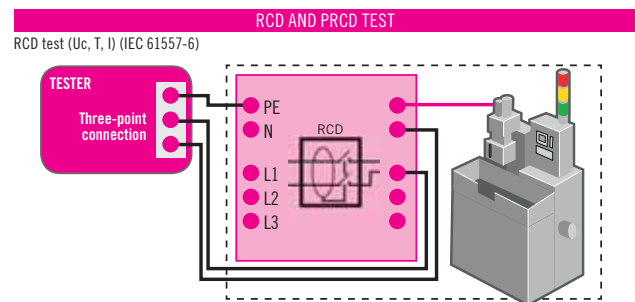

The RCD test can be used to check operation of the RCDs.

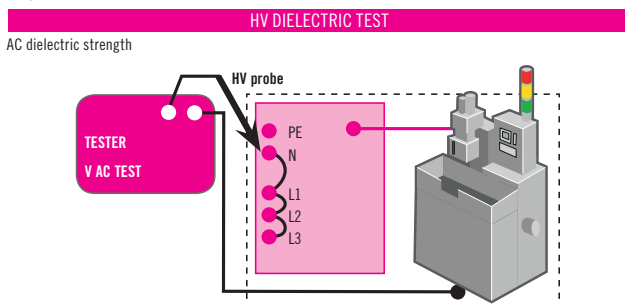

The AC dielectric test can be used to confirm the device's ability to function at its operating voltage. These tests are performed at a higher voltage than the normal operating voltage.

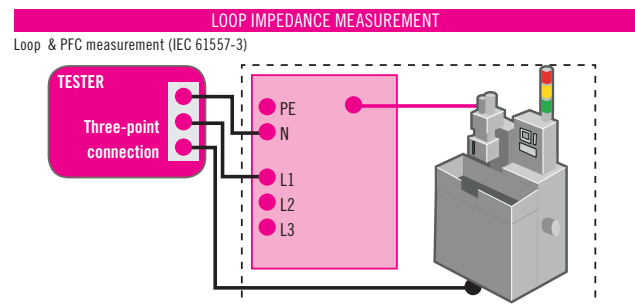

By measuring the loop impedance and calculating the prospective fault current (PFC), you can check that the automatic cut-off systems or fuses are appropriately sized.

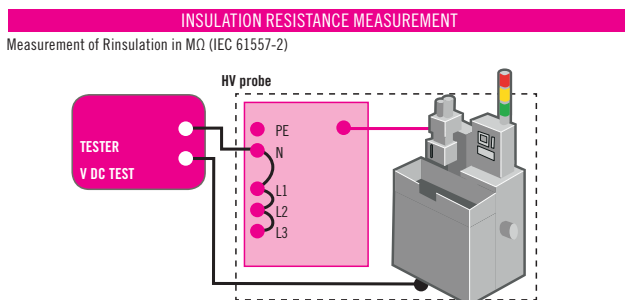

By measuring the insulation resistance, it is possible to detect faults due to deterioration or pollution and mould.

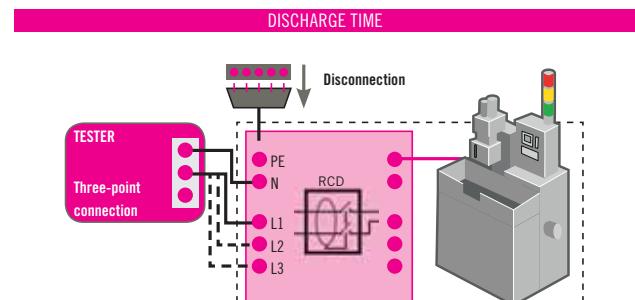

When the machines are disconnected, high-value capacitors may supply a hazardous voltage. This test measures whether the time taken by the discharge voltage to reach a non-hazardous value complies with the requirements ($< 5s / < 1s$).



TECHNICAL OVERVIEW / OTHER TESTERS

MEASUREMENT OF LOW RESISTANCES

The measurement of low resistances is **widely used in preventive maintenance** to check the continuity of the chassis-earths, surface condition and metallization, the quality of the contacts in the switches and relays, the resistance of the cables and windings, to assess motor and transformer heating and, in general, to check the mechanical joints. A wide variety of fields are involved, including the automotive sector, telecommunications, transport, motor and transformer manufacturers, etc. as well as the repair and maintenance companies working in these different sectors.

Measurement principle

The basic principle for measuring resistance involves applying Ohm's Law: $U = R \times I$. When measuring very low resistances, a measurement current is injected and the resulting voltage is measured on the terminals of the resistance to be checked. The connections are the same as for 4-wire measurements, often called a Kelvin assembly, which limits the influence of the measurement leads when measuring low resistances.

The connection diagram is shown opposite:

From a DC voltage source U , a generator supplies a current with the value I .

A voltmeter measures the voltage drop U_x at the terminals of the resistor R_x to be measured and displays $R_x = U_x / I$. The result is

independent of the other resistances encountered in the current loop (R_i , R_f , R_c), as long as the total voltage drop which they

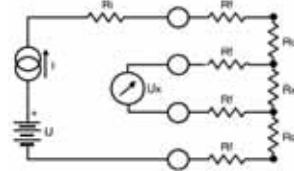

Where: R_i = internal resistance of the instrument, R_f = resistance of the measurement wires, R_c = contact resistance, R_x = resistance to be measured

cause with R_x remains lower than the voltage which the current source can supply.

In practice, double retractable test probes, pivoting or otherwise, or Kelvin clamps are used for better contact with the object to be tested. Lastly, when measuring on a rivet, the two contacts of a given test probe must be capable of retracting by different amounts.

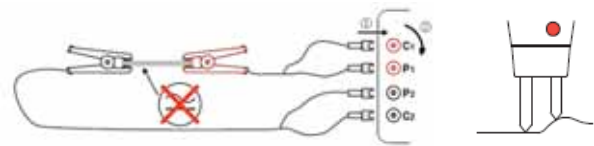

The micro-ohmmeters must offer a resolution of $1 \mu\Omega$ or even $0.1 \mu\Omega$, a wide measurement range and compensation of the thermocouple effects by inversion of the measurement current. To ensure operator safety, the equipment must be protected against accidental overvoltages, prevent measurement in the presence of a disturbance voltage and trigger automatic discharging after measurements on inductive objects.

Lastly, as the resistance of metals changes significantly according to the temperature, it is a good idea to present the result at a given reference temperature. The instruments with the best performance automatically perform this calculation according to the type of metal, its temperature coefficient (approximately $0.4 \%/^{\circ}\text{C}$ for copper or aluminium), the ambient temperature and the reference temperature.

MEASUREMENT OF THE TRANSFORMER RATIO AND EXCITATION CURRENT

Strict compliance with the primary / secondary ratio values of the voltage, power and current transformer is crucial because any variation of these values over time is a sign of problems in the transformer, such as internal damage, possible deterioration of the insulants due to mechanical damage or contamination or short-circuits between loops. In addition, accurate measurement of the

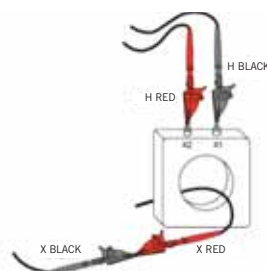

excitation current can identify problems in the magnetic core of the transformer, such as type and thickness of the material, mechanical stresses and air-gap and assembly variations.

By checking the winding polarity and the presence of open circuits or groups of terminals in open circuit, it is possible to detect rewiring errors after maintenance operations. **Transformer ratio measurements performed using the method described in the IEEE C57.12-90™ - 2006 reference document ensure standard, repeatable measurements.**

As such measurements are often performed in environments where a lot of noise is present, it is important for the operator to



be able to choose different filters in order to obtain more reliable results in such environments. Operator safety is ensured by a technique involving primary excitation, thus guaranteeing that no hazardous signal can occur at the secondary terminals of the transformer being tested.

Storage of different “boilerplates” (specifications) in the instrument and direct display of the ratio value and its

percentage deviation from the rated value help to speed up interpretation of the measurements performed.

Their long battery life and their storage capacity for the results make digital ratiometers particularly useful for performing and analysing measurements.

MOTOR DIRECTION AND PHASE ROTATION TESTS

Interconnection of several sections of the electrical network or several buildings on the same site in a three-phase system requires the phase sequence to follow the normal direction. This is **particularly crucial for the power supplies of rotating machines as the rotation order of the phases connected determines the direction of the rotating field and therefore the rotation direction of the rotor.**

Phase rotation direction

The phase rotation direction can be determined by connecting the three phases of the electrical network to be tested to the tester, in accordance with the markings. **The tester then indicates the phase rotation direction:** clockwise or anticlockwise. In this case, the tester is self-powered via the measurement inputs.

To cover a wide range of applications, **the equipment must be capable of operating at frequencies from 15 to 400 Hz.**

Rotating field direction or rotation direction without connection

For some phase sequence detectors, the possibility of testing without connection, simply by positioning the

tester on the casing of the motor, allows you to obtain a quick indication of the rotating field direction. In this mode, the tester must be set up in parallel to the rotor and in the prescribed direction. This principle is not valid when controlling a motor by means of a frequency converter.

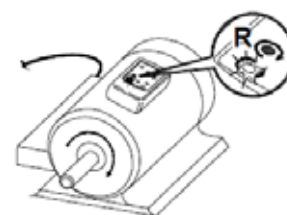

Determination of the phase connection direction on a motor

If you connect the motor's power supply phases to the tester and turn the rotor half a turn to the right by hand, the tester indicates whether or not the phase wires are connected in the right order.

Indication of solenoid valve activation without connection

On testers capable of testing without connection, the activation of a solenoid valve can be detected by placing the tester close to the valve. The clockwise or anticlockwise LED then indicates the direction of the field generated.

BATTERY CAPACITY MEASUREMENT

Research carried out by battery manufacturers has shown that **the internal impedance of a rechargeable battery increases with its age and the number of discharges which it has undergone.** By analysing the internal impedance, you can therefore assess the condition of the elements inside and determine whether the battery needs to be replaced or not.

Instead of the absolute value of the battery's internal resistance, it is the variation of the value which is important. Indeed, a 25% increase causes performance to fall by approximately 80%. These values may vary according to the battery technology involved. These values are compared with the instantaneous measurements made and noted when the batteries were installed.

Preventive maintenance equipment should simultaneously measure and display the internal resistance by means of a 4-wire method for AC at a

frequency close to 1 kHz, **as well as the open-circuit voltage.** As the internal resistance values measured may be low, you have to compensate the resistance of the measurement leads and retractable test probes.

A large number of alarm comparison systems are used to quickly detect battery deterioration. On the basis of this comparison, the result is assessed and one of the LEDs (PASS, WARNING, FAIL) is then activated accordingly.

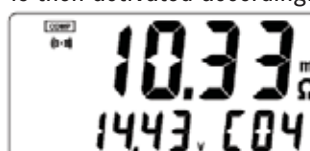
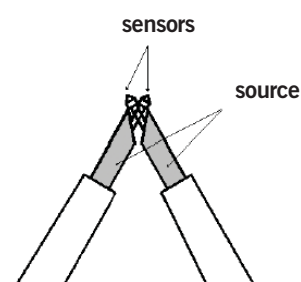



CHOOSING YOUR INSTALLATION TESTER



C.A 6030
page 63



C.A 6113
page 64



C.A 6116N
page 64



C.A 6117
page 64

Insulation					
	50 / 100 / 250 / 1000 V		■	■	■
RCD tests					
	No-trip tests	■	■	■	■
	Trip time (pulse)	■	■	■	■
	Trip current (Ramp)	■	■	■	■
	Management of standards or selective RCDs, type AC or A	■	■	■	■
	Management of type-B RCDs				■
Earth management					
	2P/3P earth		■	■	■
	1P live earth (RA)	■	■	■	■
	Selective earth with 1 clamp (RA Sel)		■	■	■
Impedance & loop resistance					
	Z-loop (L-PE)	■	■	■	■
	Z-Line (L-N or LL)		■	■	■
	I _k calculation (PFC)	■	■	■	■
	I _{sc} calculation (PSCC)		■	■	■
	Integrated fuse table				■
	Voltage drop				■
Resistance / Continuity					
	Manual & automatic measurements		■	■	■
Other functions					
	Voltage / frequency	■	■	■	■
	Current / leakage current on clamp	■	■	■	■
	Phase sequence	■	■	■	■
	Power values			■	■
	Harmonics			■	■
	Wiring polarity: test + reversal		■	■	■
	Alarms	■	■	■	■
Storage / Communication					
	Storage	■		■	■
	Storage of 3 tree-structure levels			■	■
	Optical interface	■			
	USB interface			■	■
Display and power supply					
	Black and white LCD	■			
	Black and white graphical LCD		■		
	Colour graphical LCD			■	■
	Online help		■	■	■
	Battery operation	■			
	Operation with rechargeable batteries		■ Ni-Mh	■ Li-ion	■ Li-ion
PC software					
	ICT/ DataView®			■	■
	Transfer View	■			
Safety / Standards					
	IEC 61010-1 600 V CAT III	■	■	■	■
	IEC 61557	■	■	■	■



C.A 6030

Ref.: P01191511

600 V CAT III	IP 54
------------------	----------

STRENGTHS

- Dedicated to RCD testing
- Earth loop measurement without tripping the RCD
- Automatic detection of the L/N/PE positions on the mains socket
- Optical communication for data printing and transfer

SPECIFICATIONS

	C.A 6030
Voltage measurement	2 to 550 V (DC or RMS) at connection
Frequency	15.3 Hz to 450 Hz at connection
Wiring polarity: test + inversion	Yes
RCD tests	
Rated voltage / frequency of the installation	90 to 550 V / 15.3 to 65 Hz
$I_{\Delta n}$	10 / 30 / 100 / 300 / 500 mA + variable from 6 mA to 650 mA
No-trip test	$\frac{1}{2} I_{\Delta n}$
Trigger time	$I_{\Delta n}$, 2 $I_{\Delta n}$, 5 $I_{\Delta n}$, 150 mA, 250 mA
Trigger current	Step mode
L-PE loop measurement (without RCD trip > 30 mA)	
Rated voltage / frequency of the installation	90 to 550 V / 15.3 to 65 Hz
Measurement range	0.1 Ω to 4,000 Ω
Accuracy	10 % of the value +15 cts
Measurement current	0.1 to 0.5 $I_{\Delta n}$
Short-circuit current calculation (I_{sc})	
	Up to 2.75 kA
Live earth measurement (1 stake) (no RCD trip > 30 mA)	
Rated voltage / frequency of the installation	90 to 550 V / 15.3 to 65 Hz
Measurement range	0.1 Ω to 4000 Ω
Accuracy	10 % of value + 15 cts
Measurement current	0.1 to 0.5 $I_{\Delta n}$
Phase rotation	
	90 < voltage present < 550 V
Current / leakage current (with optional current clamp)	
MN20 clamp	5 mA to 20 A
C172 clamp	5 mA to 20 A
C176 clamp	50 mA to 200 A
Cable compensation	
	Yes
Alarms	
	In each function
Memory	
	100 measurements
Communication output	
	Optical interface
Power supply /Electrical safety	
	6 x 1.5 V batteries / IEC 61010-1 - 600 V CAT III
Display	
	Backlit 4,000-count LCD
Dimensions / weight	
	211 x 108 x 60 mm / 0.9 kg

ADDITIONAL INFO

- The C.A 6030 is delivered as standard with a European mains power socket
- It can also be delivered with a 1P loop-measurement kit:
- C.A 6030 + 1P loop kit [P01299921](#)

CONTENTS

- C.A 6030 delivered in a "neck-strap" bag with 1 shoulder bag for accessories containing 1 measurement lead with a European mains power socket,
- 1 measurement lead with 3 separate cables,
- 3 crocodile clips
- 3 test probes
- Data transfer software
- 1 optical communication cable

ACCESSORIES / REPLACEMENT PARTS

- C172 current clamp [P01120310](#)
- C176 clamp [P01120330](#)
- See all the accessories on page 102

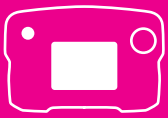

C.A 6113 - C.A 6116N - C.A 6117

Ref.: P01145445

P01145455

P01145460



STRENGTHS

- Tests on RCDs (types AC, A and B)
- Battery life of up to 30 hours
- Testing according to IEC 60364-6, NF C 15-100, VDE 100, FD C 16-600...
- Automatic continuity measurement
- Colour screen (except C.A 6113)
- Measurements: voltage, current via clamp, power, waveforms and harmonics
- Loop measurement with 1 mΩ resolution

CONTENTS

- **C.A 6113** delivered in a shoulder bag with:
 - 1 x PA 30 W power pack
 - 1 Euro 3-point lead - 3 safety leads (red, blue, green)
 - 3 test probes Ø 4 mm (red, blue, green)
 - 3 crocodile clips (red, blue, green)
 - 2 elbowed-straight safety leads (red and black) 3 m long
 - 1 three-point Euro mains lead
 - 1 remote-control probe
 - 1 anti-scratch film mounted on the instrument
 - 1 wrist-strap
 - 1 x 4-point hands-free strap
 - 1 CD-ROM containing the user manual
- **C.A 6116N** and **C.A 6117** delivered in a shoulder bag with:
 - 1 mains power / charger pack (type 2)
 - 1 Li-Ion rechargeable battery pack mounted on the instrument
 - 1 USB A/B cable 1.80 m long with ferrite
 - 1 three-point lead - 3 safety leads (red, green and blue)
 - 3 test probes Ø 4 mm (red, green and blue)
 - 3 crocodile clips (red, green and blue)
 - 2 elbowed-straight safety leads 3 m long (red and black)
 - 1 three-point EURO mains lead
 - 1 two-point EURO mains lead
 - 1 remote-control probe
 - 1 anti-scratch film mounted on the instrument
 - 1 wrist-strap
 - 1 x 4-point hands-free strap
 - ICT data export software on CD-ROM
 - 1 CD-ROM containing the user manual

ACCESSORIES / REPLACEMENT PARTS

- Three-point lead with separated wires 2.5 m P01295398
- Three-point lead for testing European mains sockets P01295393
- See all the accessories on page 102

EFFECTIVE CONTEXTUAL HELP AND GUARANTEED SAFETY

These testers are equipped with **clear, detailed contextual help**. This makes them suitable for both experts and less-experienced users.

There is dedicated help for each measurement, including a guide to the connections to be set up and **help for interpreting the results**. For greater safety, if it is incorrectly connected or if a hazardous voltage is present, the instrument displays an error message in order to warn the user.

ADDITIONAL INFO

- Integrated fuse table for quick result readings on the instrument
- User-friendly interface
- Extra-wide graphical screen
- Integrated contextual help for each function
- ICT data export software provided
- Compatible with the DataView® software
- Delivered as standard with a three-point European mains lead



INSTALLATION TESTERS

SPECIFICATIONS

		C.A 6113	C.A 6116N	C.A 6117
Continuity / Resistance				
Measurement current		I > 200 mA up to 39.99 Ω and 12 mA approx. up to 400 Ω		
Accuracy		± (1.5% of measurement + 2 cts), with audible beep		
Range		4kΩ / 40kΩ - 400kΩ		
Insulation				
Test voltage		50 / 100 / 250 / 500 / 1,000 V DC		
Range / accuracy		0.01 MΩ to 2 GΩ / ±(5 % of measurement + 3 cts)		
Short-circuit current		≤ 3mA		
Earth				
3P earth	Range	0.50 Ω to 15 kΩ		
	Accuracy	±(2 % of measurement + 2 cts)		
	Others	RH & RS auxiliary-stake resistance measurement (up to 40 kΩ)		
1P selective earth	Range / accuracy	0.20 Ω to 399.9 Ω ±(10 % of measurement + 10 cts) (ISel via clamp)		
Loop impedance (Zs (L-PE) and Zi (L-N or L-L) – 1P live earth)				
Live earth	Installation voltage / freq.	990 to 500 V / 15.8 to 17.5 Hz - 45 to 65 Hz		
High-current mode - Zs (L-PE) (TRIP) & Zi (L-N or L-L)	Range / accuracy	Max. test current: 7.5 A 0.100 Ω to 399.99 Ω / ±(5% of measurement + 2 cts)		
NO TRIP mode (Zs (L-PE))		Test current: 6 mA – 9 mA – 12 mA (as required) - 0.20 Ω to 3,999 Ω ±(5% of measurement + 2 cts)		
Calculation of short-circuit current I _k (PFC (Zs)), I _{Sc} (PSCC (Zi))		Fault and short-circuit current: display range 0.1 A to 6 kA		
Integrated fuse table				Yes
Voltage drop ΔU% (Zi)				-40% to + 40%
Others		Measurement of the resistive and inductive components of the impedances Zs and Zi		
RCDs				
RCD types AC and A	Installation voltage / freq.	90 V to 500 V / 15.8 Hz to 17.5 Hz and 45 Hz to 65 Hz		
	IΔn	10/30/100/300/500/650/1000 mA (90V – 280V) or variable - 10/30/100/300/500 mA (280-550V) or variable Ramp and pulse test		
	No-trip test	½ IΔn – Duration: 1,000 ms or 2,000 ms		
	Trip current Ramp mode	0.3 x IΔn to 1.06 x IΔn per increment of 3.3% x IΔn		
	Trip time measurement Pulse mode	0.2 à 0.5 x IΔn (Uf) / 0.5 x IΔn / 2 x IΔn (selective) / 5 x IΔn. Pulse: 0 to 500 ms, Ramp mode: 0 to 200 ms		
Type-B RCDs	Installation voltage / freq.			90 V to 275 V / 15.8 Hz to 17.5 Hz and 45 Hz to 65 Hz
	IΔn: ramp / pulse 2 x IΔn pulse 4 x IΔn			10/30/100/300/500 mA 10/30/100 mA
	Test in Ramp mode			0.2 x IΔn to 2.2 x IΔn
	Trip test			1.1x2 or 2.2x2 or 2.2x4 x IΔn
Other measurements				
Current		(1 mA*) 5.0 mA to 19.99 A (MN77 clamp) / 5.0 mA to 199.9 A (C177A clamp)		
Voltage		0 to 550 V AC/DC / DC and 15.8 to 500 Hz		
Frequency		10 to 500 Hz		
Phase rotation		20 to 500 V _{AC}		
Active power		0 to 110 kW single-phase - 0 to 330 kW three-phase Simultaneous display of the voltage and current waveforms		
Harmonics		Voltage and current / up to 50th order / THD-F / THD-R		
General specifications				
Large backlit LCD screen, 320 x 240 pts		monochrome graphical 5.7 "		colour graphical 5.7"
Memory/Communication				1,000 tests, via USB for data transfer and report creation
Power supply: rechargeable battery		NiMH 9.6 V rated 4 Ah.		Lithium-ion 10.8 V rated 5.8 Ah
Battery life		up to 24 hours		up to 30 hours
Dimensions / weight		280 x 190 x 128 mm / 2,2 kg		
Ingress protection / EMC		IP 53 / IK04 / IEC 61326-1		
Electrical safety / standards		IEC 61010 -1 – 600 V CAT III – 300 V CAT IV – IEC 61557		

*if a voltage is connected to the instrument



CHOOSE YOUR PORTABLE INSULATION TESTER



Type	Hand-cranked		Analogue		Portable digital						
Test voltage (in Vac)											
10									■	■	■ 1 V increments
25									■	■	■ 1 V increments
50						■	■	■			■ 1 V increments
100						■	■	■	■		■ 1 V increments
250		■			■	■	■		■		
500	■	■	■	■	■	■	■		■		
1,000		■		■	■	■	■				
Max. measured value											
200 MΩ	■										
1 GΩ			■	■							
5 GΩ		■									
20 GΩ								■		■	
40 GΩ					■						
50 GΩ									■		
200 GΩ						■	■				
Continuity	■		■	■	■	■	■	■	■	■	
Resistance	■			■		■	■	■	■	■	■
Capacitance							■	■			
Leakage current						■	■	■	■	■	■
Chronometer					■	■	■	■	■	■	
Test duration programming					■	■	■	■	■	■	
Quality ratios											
PI						■	■	■			
DAR						■	■	■			
Graphical											
Storage						■	■	■	■		
Bluetooth							■	■	■		
Display											
Analogue	■	■	■	■							
LCD + bargraph					■	■	■	■	■	■	
Power supply											
Hand-cranked	■	■									
Batteries			■	■	■	■	■	■	■	■	■



CHOOSE YOUR PORTABLE INSULATION TESTER



C.A 6541

page 72



C.A 6543

page 72



C.A 6505

page 73



C.A 6545

page 74



C.A 6547

page 74



C.A 6549

page 75



C.A 6550

page 76



C.A 6555

page 76

Type	On-site digital							
TEST VOLTAGE (in V _{oc})								
50	■	■	■	■	■	■	■	■
100	■	■	■	■	■	■	■	■
250	■	■	■	■	■	■	■	■
500	■	■	■	■	■	■	■	■
1,000	■	■	■	■	■	■	■	■
2,500			■	■	■	■	■	■
5,000			■	■	■	■	■	■
variable from 50 to 5,100			■	■	■	■	■	■
10,000							■	■
variable from 40 to 10,000							■	■
15,000								■
variable from 40 to 15,000								■
Max. measured value								
4 TΩ	■	■						
10 TΩ			■	■	■	■		
25 TΩ							■	
30 TΩ								■
Continuity								
Continuity	■	■						
Resistance								
Resistance	■	■		■	■	■	■	■
Capacitance								
Capacitance	■	■	■	■	■	■	■	■
Leakage current								
Leakage current				■	■	■	■	■
Chronometer								
Chronometer	■	■		■	■	■	■	■
Programming of test duration								
Programming of test duration	■	■	■	■	■	■	■	■
Quality ratios								
PI	■	■	■	■	■	■	■	■
DAR	■	■	■	■	■	■	■	■
DD				■	■	■	■	■
Graphical								
R (t)	■	■		■	■	■	■	■
u(t) + i(t)							■	■
i(u)							■	■
Ramp								
Ramp							■	■
Ramp by voltage steps							■	■
R calculation (Tref)							■	■
I limit							■	■
Early break / burn-in							■	■
Storage								
Storage	■	■			■	■	■	■
RS 232		■						
USB							■	■
Display								
LCD + bargraph	■	■	■	■	■			
Graphical							■	■
Power supply								
Batteries	■							
Rechargeable battery		■	■	■	■	■	■	■



HAND-CRANKED INSULATION TESTERS



C.A 6501 - C.A 6503

Ref. : P01132503

P01132504

300 V
CAT III

IP
54

STRENGTHS

- Rugged plastic casing ideal for all-terrain use
- Special for on-site use
- No power supply required

SPECIFICATIONS

	C.A 6501	C.A 6503
Insulation		
Test voltage (DC)	500 V	250 V / 500 V / 1000 V
Range	0.5 to 200 MΩ	1 to 5,000 MΩ
Accuracy	2.5 % of full scale	2.5 % of full scale
Resistance		
Range	45 to 500 kΩ	-
Accuracy	2.5 % of full scale	-
Continuity		
Range	0 to 100 Ω	-
Accuracy	2.5 % of full scale	-
Voltage		
Range	0... 600 Vac	
Frequency	45 to 450 Hz	
Accuracy	3 % of full scale	
Display	Analogue	
Dimensions / weight	120 x 120 x 130 mm / 1.06 kg	
Power supply	Hand-cranked magneto providing a stable voltage	
Ingress protection	IP 54 with cover IP 52 without cover	
Electrical safety	IEC 61010 - 600 V CAT II / 300 V CAT III	

CONTENTS

- C.A 6501 delivered in a shoulder bag
- 2 elbowed / straight PVC leads 1.5 m long (black/red)
- 2 crocodile clips (black/red)
- 1 black test probe
- C.A 6503 delivered in a shoulder bag
- 3 elbowed/straight PV leads 1.5 m long (black/red/blue)
- 3 crocodile clips (black/red/blue)
- 1 black test probe

ACCESSORIES / REPLACEMENT PARTS

- Shoulder bag no. 2 _____ P01298006
- C.A 846 thermo-hygrometer _____ P01156301Z
- See all the accessories on page 102



C.A 6511 - C.A 6513

Ref. : P01140201

P01140301

600 V
CAT IIIIP
40

STRENGTHS

- Simple to use
- Rugged thanks to their shockproof sheath

SPECIFICATIONS

	C.A 6511	C.A 6513
Insulation		
Test voltage (DC)	500 V	500 V / 1000 V
Range	0.1 to 1,000 MΩ	
Accuracy	± 5 % of measurement	
Resistance		
Range	-	0 to 1,000 Ω
Accuracy	-	± 3 % of full scale
Continuity		
Range	-10 Ω to +10 Ω	
Accuracy	± 3 % of full scale	
Measurement current	≥ 200 mA	
Current reversal	Yes	
Voltage		
Range	0... 600 V _{ac}	
Frequency	45 to 400 Hz	
Accuracy	± 3 % of full scale	
Display	Analogue	
Dimensions / weight	167 x 106 x 55 mm / 500 g (excl. sheath)	
Power supply	4 x 1.5 V LR06 batteries	
Electrical safety	IEC 61010 - 600 V CAT III	

ADDITIONAL INFO

- **C.A 6511** : insulation at 500 V, continuity at 200 mA
- **C.A 6513** : insulation at 1,000 V, continuity at 200 mA and resistance

CONTENTS

- **C.A 6511** and **C.A 6513** delivered mounted in their shockproof sleeves
- 2 elbowed/straight PVC leads 1.5 m long (black/red)
- 1 black test probe
- 1 red crocodile clip
- 4 x 1.5 V LR06 batteries
- 1 replacement fuse

ACCESSORIES / REPLACEMENT PARTS

- C.A 861 thermometer + K thermocouple P01650101Z
- C.A 846 thermo-hygrometer P01156301Z
- See all the accessories on page 102



C.A 6522 - C.A 6524 - C.A 6526

Ref.: P01140822 P01140824 P01140826



STRENGTHS

- Test voltage from 50 to 1,000 V
- Measurement range from 10 kΩ to 200 GΩ
- PI and DAR ratios to determine the quality of the insulation
- Alarms and Pass/Fail indicator LEDs (C.A 6526)
- Storage of up to 1,300 measurements

CONTENTS

- C.A 6522, C.A 6524 or C.A 6526
- 1 "hands-free" bag
- 2 elbowed-straight safety leads (red and black) 1.50 m long
- 1 red crocodile clip
- 1 black test probe
- 6 x LR6 batteries
- 1 CD-ROM containing the multilingual user manual
- 1 safety datasheet in 20 languages
- In addition, for the C.A 6526: 1 CD-ROM containing the Megohmmeter Transfer software

ACCESSORIES / REPLACEMENT PARTS

- Type-3 remote-control probe P01102092A
- 2 elbowed-straight safety leads (red and black) 1.50 m long P01295453Z
- See all the accessories on page 102

SPECIFICATIONS

	C.A 6522	C.A 6524	C.A 6526
Industrial maintenance			
Voltage			
Measurement range / resolution	0.3 V - 399.9 V / 0.1 V; 400 V - 700 V / 1 V		
Accuracy / Input impedance	± (3 % + 2 cts) / 400 KΩ		
Operating frequency	DC; 15.3 - 800 Hz		
Frequency			
Measurement range / resolution / accuracy	-	15.3 Hz - 399.9 Hz / 0.1 Hz / ± (1 % + 2 cts) 400 - 800 Hz / 1 Hz / ± (1 % + 1 ct)	
Insulation			
Test voltage	250-500-1,000 V	50 - 100 - 250 - 500 - 1,000 V	
Range at maximum test voltage	40 GΩ	200 GΩ	
Compliance with IEC 61557-2 standard	2 GΩ		
Measurement range: 50 V	-	10 kΩ - 10 GΩ	
100 V	-	20 kΩ - 20 GΩ	
250 V	50 kΩ - 10 GΩ	50 kΩ - 50 GΩ	
500 V	100 kΩ - 20 GΩ	100 kΩ - 100 GΩ	
1,000 V	200 kΩ - 40 GΩ	200 kΩ - 200 GΩ	
Measurement range / resolution	10 ¹⁰ - 999 KΩ and 1,000 - 3,999 MΩ / 1 KΩ; 4.00 - 39.99 MΩ / 10 kΩ 40.0 - 399.9 MΩ / 100 KΩ; 400 - 3,999 MΩ / 1 MΩ 4.00 - 39.99 GΩ / 10 MΩ; 40.0 - 200 GΩ / 100 MΩ		
Accuracy	± (3 % + 2 cts) ⁽²⁾		
Test voltage (I < 1 mA)	-0 % + 20 %		
Test voltage display	± (3 % + 3 cts)		
Test current / resolution	-	0.01 μA - 39.99 μA / 10 nA; 40.0 - 399.9 μA / 100 nA; 0.400 - 2.000 mA / 1 μA	
Test current accuracy	-	± (10 % + 3 cts)	
PI/DAR ratios	-	10 min / 1 min - 1 min / 30 s	
Timer (min:s)	0:00 - 39:59		
Discharge time (at 25 V)	< 2 s/μF		
Alarms	-	2 fixed thresholds + 1 prog. threshold	
Continuity			
Continuity measurement range	0.00 Ω - 10.00 Ω (200 mA)	0.00 Ω - 10.00 Ω (200 mA) 0.0 - 100.0 Ω (20 mA)	
Accuracy / Open-circuit voltage	± (2 % + 2 cts) / ≥ 6 V		
Measurement current	200 mA : 200 mA (-0 mA + 20 mA) - 20 mA : 20 mA ± 5 mA		
Continuity thresholds (fast beep)	2 Ω fixe	2 Ω, 1 Ω, programmable threshold	
Cable compensation	Up to 9.99 Ω		
Resistance			
Measurement range / resolution	-	0 - 3,999 Ω / 1 Ω 4.00 kΩ - 39.99 kΩ / 10 Ω 40.0 kΩ - 399.9 kΩ / 100 Ω 400 kΩ - 1,000 kΩ / 1 kΩ	
Accuracy	± (3 % + 2 cts)		
Capacitance			
Measurement range / resolution	-	-	0.1 nF - 399.9 nF / 0.1 nF 400 nF - 3,999 nF / 1 nF 4.00 μF - 10.0 μF / 10 nF
Accuracy	-	-	± (3 % + 2 cts)
Line length			
General specifications			
Display	2 x 4,000 cts + logarithmic bargraph		
Storage	-	300 measurements	1,300 measurements
Communication	-	-	Bluetooth® Class II
Power supply / automatic power-off	6 x LR6 batteries / 5 min, deactivatable		
Battery life	1,500 measurements : U _N x 1 kΩ @ U _N (5 s ON / 55 s OFF) 3,000 continuity measurements (5 s ON / 55 s OFF)		
Dimensions / weight / IP rating	211 x 108 x 60 mm / 850 g / IP 54 / IK 04		
EMC / Electrical safety	IEC 61326-1 / IEC 61010-1 and IEC 61010-2-030, 600 V CAT IV		
Compliance with standards	IEC 61557 parts 1, 2, 4 and 10		

(1): 2 kΩ for the C.A 6532, C.A 6534 and C.A 6536.
(2): To be added: 10 V: 1 % per 0.1 GΩ; 25 V: 0.4 % per 0.1 GΩ; 50 V: 2 % per GΩ; 100 V: 1 % per GΩ; 250 V: 0.4 % per GΩ; 500 V: 0.2 % per GΩ; 1,000 V: 0.1 % per GΩ.



C.A 6532 - C.A 6534 - C.A 6536

Ref.: P01140832

P01140834

P01140836



STRENGTHS

- Test voltage from 50 to 500 V
- Measurement range from 2 kΩ to 50 GΩ
- ΔRel mode and configurable alarms
- Measurement of capacitance per unit length in nF/km (C.A 6532)
- 200 mA / 20 mA continuity with active fuseless protection

CONTENTS

- C.A 6532, C.A 6534 ou C.A 6536
- 1 "hands-free" bag
- 2 elbowed-straight safety leads (red and black) 1.50 m long
- 1 red crocodile clip
- 1 black test probe
- 2 wire grips (red/black)
- 6 x LR6 batteries
- 1 CD-ROM containing the multilingual user manual
- 1 safety datasheet in 20 languages
- 1 CD-ROM containing the Megohmmeter Transfer software (except C.A 6536)

ACCESSORIES / REPLACEMENT PARTS

- Type 3 remote-control probe P01102092A
- 2 elbowed-straight safety leads (red and black) 1.50 m long P01295453Z
- See all the accessories on page 102

SPECIFICATIONS

	C.A 6532	C.A 6534	C.A 6536
	Telecom	Electronics	Avionics, ESD, aerospace, defence
Voltage			
Measurement range / resolution	0.3 V - 399.9 V / 0.1 V; 400 V - 700 V / 1 V		
Accuracy / input impedance	± (3 % + 2 cts) / 400 kΩ		
Operating frequency	DC ; 15.3 - 800 Hz		
Frequency			
Measurement range / resolution / Accuracy	153 Hz - 399.9 Hz / 0.1 Hz / ± (1 % + 2 cts) 400 - 800 Hz / 1 Hz / ± (1 % + 1 ct)	-	-
Insulation			
Test voltage	50 - 100 V	10-25-100-250-500 V	10 to 100 V 1 V increments
Range at maximum test voltage	20 GΩ	50 GΩ	20 GΩ
Compliance with IEC 61557-2 std	2 GΩ		
Measurement range: 10 V	10 kΩ - 10 GΩ 20 kΩ - 20 GΩ	2 kΩ - 1 GΩ	2 kΩ - 2 GΩ
25 V		5 kΩ - 2 GΩ	(UN/5) kΩ to (UN/5) GΩ
50 V		20 kΩ - 10 GΩ	20 kΩ - 20 GΩ
100 V		50 kΩ - 25 GΩ	20 kΩ - 20 GΩ
250 V		100 kΩ - 50 GΩ	20 kΩ - 20 GΩ
500 V			10 to 100 V
Variable test voltage			10 to 100 V
Measurement range / resolution	10 ⁰¹ - 999 kΩ and 1.000 - 3.999 MΩ / 1 kΩ; 4.00 - 39.99 MΩ / 10 kΩ 40.0 - 399.9 MΩ / 100 kΩ; 400 - 3.999 MΩ / 1 MΩ 4.00 - 39.99 GΩ / 10 MΩ; 40.0 - 200 GΩ / 100 MΩ		
Accuracy	± (3 % + 2 cts) ⁽²⁾		± (3 % + 2 cts) ⁽³⁾
Test voltage (I < 1 mA)	-0 % + 20 %		± 0.5 V
Test voltage display	± (3 % + 3 cts)		
Test current / resolution	0.01 μA - 39.99 μA / 10 nA; 40.0 - 399.9 μA / 100 nA 0.400 - 2.000 mA / 1 μA		
Accuracy of test current	± (10 % + 3 cts)		
PI/DAR ratios	10 min / 1 min - 1 min / 30 s	-	-
Timer (min:s)	0:00 - 39:59		
Discharge time (at 25 V)	< 2 s/μF		
Alarms	2 fixed thresholds + 1 programmable threshold		
Continuity			
Continuity measurement range	0.00 Ω - 10.00 Ω (200 mA); 0.0 - 100.0 Ω (20 mA)		
Accuracy / open-circuit voltage	± (2 % + 2 cts) / ≥ 6 V		
Measurement current	200 mA : 200 mA (-0 mA + 20 mA) - 20 mA : 20 mA ± 5 mA		
Continuity thresholds (fast beep)	2 Ω, 1 Ω, programmable threshold		
Cable compensation	up to 9.99 Ω		
Resistance			
Measurement range / resolution	0 - 3.999 Ω / 1 Ω; 4.00 kΩ - 39.99 kΩ / 10 Ω / ± (3 % + 2 cts) 40.0 kΩ - 399.9 kΩ / 100 Ω 400 kΩ - 1.000 kΩ / 1 kΩ / ± (3 % + 2 cts)		
Capacitance			
Measurement range / resolution	0.1 nF - 399.9 nF / 0.1 nF 400 nF - 3.999 nF / 1 nF 4.00 μF - 10.0 μF / 10 nF	-	-
Accuracy	± (3 % + 2 cts)		-
Line length	0 - 100 km	-	-
General specifications			
Display	2 x 4,000 cts + logarithmic bargraph		
Storage	1,300 measurements		
Communication	Bluetooth® Class II		
Power supply / Automatic power-off	6 x LR6 battery / 5 min, deactivatable		
Battery life	1,500 measurements: UN x 1 kΩ @ UN (5 s ON / 55 s OFF) 3,000 continuity measurements (5 s ON / 55 s OFF)		
Dimensions / weight / IP rating	211 x 108 x 60 mm / 850 g / IP 54 / IK 04		
EMC / electrical safety	IEC 61326-1 / IEC 61010-1 and IEC 61010-2-030, 600 V CAT IV		
Compliance with standards	IEC 61557 parts 1, 2, 4 and 10		

(1) : 2 kΩ for the C.A 6532, C.A 6534 and C.A 6536.

(2) : To be added: 10 V: 1 % per 0.1 GΩ; 25 V: 0.4 % per 0.1 GΩ; 50 V: 2 % per GΩ; 100 V: 1 % per GΩ; 250 V: 0.4 % per GΩ; 500 V: 0.2 % per GΩ; 1,000 V: 0.1 % per GΩ.

(3) : To be added: 10 % /UN per 100 MΩ



C.A 6541 - C.A 6543

Ref. : P01138901

P01138902

600 V
CAT III

IP
53

STRENGTHS

- Test voltages from 50 V to 1,000 V
- Wide measurement range from 2 kΩ to 4 TΩ
- Automatic calculation of DAR / PI quality ratios
- Communication for C.A 6543

SPECIFICATIONS

	C.A 6541	C.A 6543
Insulation		
Test voltage		
50 V	2 kΩ to 200 GΩ	
100 V	4 kΩ to 400 GΩ	
250 V	10 kΩ to 1 TΩ	
500 V	20 kΩ to 2 TΩ	
1,000 V	40 kΩ to 4 TΩ	
Accuracy		
2 kΩ to 40 GΩ	±5 % of value ± 3 cts	
40 GΩ to 4 TΩ	±15 % of value ± 10 cts	
Programming of test duration		
		1 to 59 min.
DAR (1 min. / 30 sec.)		
		0.000 to 9.999
PI (10 min. / 1 min.)		
		0.000 to 9.999
Adjustable PI		
		Time adjustable from 30 s to 59 min.
Voltage test / safety		
		0 to 1,000 V _{AC/DC}
Voltage alert indicator		
		Yes > 25 V
Test inhibition		
		Yes > 25 V
Smooth function		
		Yes
Continuity		
Range	0.01 to 39.99 Ω	
Measurement current	≥ 200 mA up to 20 Ω	
Resistance		
Range	0.01 to 400 kΩ	
Capacitance		
Range	0.005 to 4.999 μF	
Memory - Communication		
Storage of R(t)	20-kbyte memory	128-kbyte memory
Storage of measurements	20 measurement results	Up to 1,500 measurement results
Direct report printing	-	On locally-connected printer, fixed format
Communication port	No	RS232
PC software	No	DataView® (option)
Display		
	Giant LCD + bargraph	Giant LCD + bargraph
Power supply		
	8 x LR14 batteries	NiMH rechargeable battery
Dimensions / weight		
	240 x 185 x 110 mm / 3.4 kg	240 x 185 x 110 mm / 3.4 kg
Electrical safety		
	IEC 61010 600 V CAT III – IEC 61557	IEC 61010 600 V CAT III – IEC 61557

ADDITIONAL INFO

- Site-proof casing with highly shock-resistant lid
- Delivered with an accessories bag which can be clipped onto the site-proof casing

CONTENTS

- **C.A 6541** delivered with an accessories bag containing:
 - 1 set of 2 leads 1.5 m long (red/blue)
 - 1 black guarded lead 1.5 m long
 - 3 crocodile clips (red/blue/black)
 - 1 test probe (black)
 - 8 x LR14 batteries
- **C.A 6543** delivered with an accessories bag containing:
 - 1 set of 2 leads 1.5 m long (red/blue)
 - 1 black guarded lead 1.5 m long
 - 3 crocodile clips (red/blue/black)
 - 1 test probe (black)
 - 1 power-supply lead 2 m long
 - 1 communication cable

ACCESSORIES / REPLACEMENT PARTS

- Remote-control probe _____ P01101935
- C.A 861 thermometer + K thermocouple _____ P01650101Z
- See all the accessories on page 102



C.A 6505

Ref.: P01139704

1000 V
CAT IIIIP
53

STRENGTHS

- Fixed and programmable test voltages from 40 V to 5,100 V
- Wide measurement range from 10 kΩ to 10 TΩ
- Large LCD screen
- Automatic calculation of the DAR / PI quality ratios
- Measurement of voltage, capacitance and leakage current

SPECIFICATIONS

		C.A 6505
Insulation	Test voltage	
	500 V	10 kΩ to 2 TΩ
	1,000 V	100 kΩ to 4 TΩ
	2,500 V	100 kΩ to 10 TΩ
	5,000 V	300 kΩ to 10 TΩ
Voltage programming		40 V to 1,000 V: 10 V increments 1,000 V to 5,100 V: 100 V increments
Accuracy	1 kΩ to 400 GΩ	±5 % of value ± 3 cts
	400 GΩ to 10 TΩ	±15 % of value ± 10 cts
Programming of test duration		1 to 59 min.
DAR (1 min. / 30 sec.)		0.02 to 50.00
PI (10 min. / 1 min.)		0.02 to 50.00
Customizable PI		Time adjustable from 30 s to 59 min.
Voltage test / Safety		0 to 1,000 V _{AC/DC}
Voltage alert indicator		Yes > 25 V
Test inhibition		Yes > 25 V
Capacitance		0.001 to 49.99 μF
Leakage current measurement		0.001 nA to 3 mA
Display		Giant LCD + bargraph
Power supply		NiMH rechargeable battery
Dimensions / weight		270 x 250 x 180 mm / 4.3 kg
Electrical safety		IEC 61010 1000 V CAT III – IEC 61557

ADDITIONAL INFO

- Site-proof casing with highly shock-resistant lid
- Delivered with a shoulder bag

CONTENU

- C.A 6505 delivered with a shoulder bag containing:
 - 2 simplified measurement leads 2 m long, equipped with an HV plug at each end
 - 1 guarded safety lead 2 m long, equipped with an HV plug at one end and an HV plug with rear connection at the other end
 - 1 guarded safety lead 0.35 m long, equipped with an HV plug at one end and an HV plug with rear connection at the other end
 - 3 crocodile clips (red, blue and black)
 - 1 mains power-supply lead 1.80 m long

ACCESSORIES / REPLACEMENT PARTS

- C.A 846 thermohygrometer P01156301Z
- C.A 846 thermometer + K thermocouple P01650101Z
- See all the accessories on page 102



C.A 6545 - C.A 6547

Ref. : P01139701 P01139702

1000 V
CAT III

IP
53

STRENGTHS

- Fixed and programmable test voltages from 40 V to 5,100 V
- Wide measurement range from 30 kΩ to 10 TΩ
- Measurement filtering functions
- Automatic calculation of DAR / PI / DD ratios
- Storage and communication with the C.A 6547

SPECIFICATIONS

	C.A 6545	C.A 6547
Insulation		
Test voltage		
500 V		30 kΩ to 2 TΩ
1,000 V		100 kΩ to 4 TΩ
2,500 V		100 kΩ to 10 TΩ
5,000 V		300 kΩ to 10 TΩ
Voltage programming	40 V to 1,000 V: 10 V increments 1,000 V to 5,100 V: 100 V increments	
Accuracy		
30 kΩ to 40 GΩ	±5 % of value ± 3 cts	
40 GΩ to 10 TΩ	±15 % of value ± 10 cts	
Programming of test duration	1 to 59 min.	
DAR (1 min. / 30 sec.)	0.02 to 50.00	
PI (10 min. / 1 min.)	0.02 to 50.00	
Customizable PI	Time adjustable from 30 s to 59 min.	
DD	0.02 to 50.00	
Voltage test / Safety	0 to 1,000 V _{AC/DC}	
Voltage alert indicator	Yes > 25 V	
Test inhibition	Yes – Adjustable according to test voltage	
Smoothing function	Configurable – Digital filtering stabilizing the measurements	
Capacitance	0.005 to 49.99 μF	
Leakage current measurement	0.001 nA to 3 mA	
Memory – Communication		
Storage of R(t)	4-kbyte memory	128-kbyte memory
Storage of measurements	20 measurement results	Up to 1,500 measurement results
Direct report printing	No	On locally-connected printer, fixed format
Communication port	No	RS232
PC software	No	DataView® (option)
Display	Giant LCD + bargraph	
Power supply	NiMH rechargeable battery	
Dimensions / weight	270 x 250 x 180 mm / 4.3 kg	
Electrical safety	IEC 61010 1000 V CAT III – IEC 61557	

ADDITIONAL INFO

- Compatible with the DataView® software
- Delivered with a shoulder bag

CONTENTS

- **C.A 6545** delivered with a shoulder bag containing:
 - 2 safety leads 3 m long with HV plug and HV crocodile clip (red/blue)
 - 1 guarded safety lead 3 m long with rear-connection HV plug and HV crocodile clip (black)
 - 1 cable with rear connection (blue) 0.35 m long
 - 1 mains power cable 2 m long
- **C.A 6547** delivered with a shoulder bag containing:
 - 2 safety leads 3 m long with HV plug and HV crocodile clip (red/blue)
 - 1 guarded safety lead 3 m long with rear-connection HV plug and HV crocodile clip (black)
 - 1 cable with rear connection (blue) 0.35 m long
 - 1 mains power cable 2 m long
 - 1 communication cable

ACCESSORIES / REPLACEMENT PARTS

- C.A 846 thermo-hygrometer P01156301Z
- C.A 861 thermometer+K thermocouple P01650101Z
- See all the accessories on page 102



C.A 6549

Ref.: P01139703

1000 V
CAT IIIIP
53

STRENGTHS

- Calculation of the resistance at a reference temperature
- Graphical display of R(t) curves
- Fixed and programmable test voltages from 40 V to 5,100 V
- Wide measurement range from 30 kΩ to 10 TΩ
- Test by voltage ramp

SPECIFICATIONS

		C.A 6549
Insulation		
	Test voltage	
	500 V	30 kΩ to 2 TΩ
	1,000 V	100 kΩ to 4 TΩ
	2,500 V	300 kΩ to 10 TΩ
	5,000 V	300 kΩ to 10 TΩ
Voltage programming		
		40 V to 1,000 V: 10 V increments 1,000 V to 5,100 V: 100 V increments
Automatic voltage increments		
		Programmable value and duration up to 5 steps, three profiles stored
Accuracy		
	30 kΩ to 40 GΩ	±5 % of value ± 3 cts
	40 GΩ to 10 TΩ	±15 % of value ± 10 cts
test duration programming		
		1 to 59 min.
DAR (1 min. / 30 sec.)		
		0.02 to 50.00
PI (10 min. / 1 min.)		
		0.02 to 50.00
Customizable PI		
		Time adjustable from 30 s to 59 min.
DD		
		0.02 to 50.00
Voltage test / Safety		
		0 to 1,000 V _{AC/DC}
Voltage alert indicator		
		Yes > 25 V
Test inhibition		
		Yes – Adjustable according to test voltage
Smoothing function		
		Configurable – Digital filtering stabilizing the measurements
Capacitance		
		0.005 to 49.99 μF
leakage current measurement		
		0.001 nA to 3 mA
Memory – Communication		
	Storage of R(t)	Viewing on display + Storage of the samples
	Storage of measurements	Up to 1,500 measurement results
	Direct report printing	On locally-connected printer, fixed format
	Communication port	RS-232
	PC software	DataView® (option)
Display		
		Wide graphical screen
Power supply		
		NiMH rechargeable battery
Dimensions / weight		
		270 x 250 x 180 mm / 4.3 kg
Electrical safety		
		IEC 61010 1000 V CAT III – IEC 61557

ADDITIONAL INFO

- Compatible with the DataView® software
- Delivered with a shoulder bag

CONTENTS

- C.A 6549 delivered with a shoulder bag containing:
 - 2 safety leads 3 m long with HV plug and HV crocodile clip (red/blue)
 - 1 guarded safety lead 3 m long with rear-connection HV plug and HV crocodile clip (black)
 - 1 cable with rear connection (blue) 0.35 m long
 - 1 mains power cable 2 m long
 - 1 communication cable

ACCESSORIES / REPLACEMENT PARTS

- C.A 846 thermo-hygrometer P01156301Z
- C.A 861 thermometer+K thermocouple P01650101Z
- See all the accessories on page 102



C.A 6550 - C.A 6555

Ref. : P01139705

P01139706

1000 V
CAT IV

IP
54

SPECIFICATIONS

	C.A 6550	C.A 6555
Test voltages	10 kV	15 kV
Insulation measurement		
Ranges	500 V : 10 kΩ to 2 TΩ 1,000 V : 10 kΩ to 4 TΩ 2,500 V : 10 kΩ to 10 TΩ 5,000 V : 10 kΩ to 15 TΩ 10,000 V : 10 kΩ to 25 TΩ	15,000 V : 10 kΩ to 30 TΩ
Fixed test voltages	500 / 1,000 / 2,500 / 5,000 / 10,000 V	500 / 1,000 / 2,500 / 5,000 / 10,000 / 15,000 V
Variable test voltages	40 V - 10,000 V 3 preconfigurable voltage values	40 V - 15,000 V 3 preconfigurable voltage values
Adjustment increment for variable voltages	Variable: 40-10 kV Increment: 40 V - 1 kV: 10 V 1 kV - 10 kV: 100 V	Variable: 40-15 kV Increment: 40 V - 1 kV: 10 V 1 kV - 15 kV: 100 V
Ramp mode	3 preconfigurable ramps: start voltage / end voltage / duration	
Ramp configuration range	40-1,100 V / 500-10,000 V	40-1,100 V / 500-15,000 V
Step mode	Up to 10 plateaux (values and duration configurable for each plateau)	
Voltage measurement before and after test	AC : 0 - 2,500 V	DC : 0 - 4,000 V
Capacitance measurement (> 500 V)	0.001-9.999 μF / 10.00-49.99 μF	
Leakage current measurement	0 - 8 mA	
Discharge after test	Yes / automatic	
Additional test stop modes		
I-limit	Programmable 0.2 - 5 mA	
Early-break	di/dt	
Timer	Up to 99:59 minutes	
Debug mode	Burn-in Permanent test	
Calculation of ratios	PI, DAR, DD, SV, ΔR (ppm/V)	
Calculation of R at ref. temp.	Yes	
Measurement display filter	3 filters with variable time constant	
Graphs on display	R(t)+u(t) ; i(t) ; i(u)	
Storage	256 recordings, 80,000 cts R, U, I and date-stamp	
Communication	Optically-isolated port for USB and RS232 connection	
PC software	DataView®	
Power supply	NiMH rechargeable batteries, 8 x 1.2 V / 4,000 mAh Charging by 90-260 V 50/60 Hz external voltage	
Electrical safety	1000 V CAT IV - IEC 61010-1 and IEC 61557	
Dimensions / weight	406 x 330 x 174 mm, 6 kg approx.	

STRENGTHS

- Fixed and programmable test voltages from 40 V to 10/15 kV
- Wide measurement range from 10 kΩ to 30 TΩ
- 5 mA charging current
- Digital graphical display and bargraph of the R(t) + U(t), i(t) and i(u) curves in real time
- Ramp and voltage step tests

ADDITIONAL INFO

- Resistance calculation at a reference temperature
- memory capacity: 80,000 measurements
- Optically-isolated USB communication
- 2 levels of diagnostics available :
 - Go / No go
 - Qualitative measurement for preventive maintenance

CONTENTS

- C.A 6550 and C.A 6555 delivered with a shoulder bag containing:
 - 2 safety leads 3 m long equipped with an HV plug at each end (red/blue)
 - 1 guarded safety lead 3 m long equipped with an HV plug at one end and an HV plug with rear connection at the other end (black)
 - 3 crocodile clips (red, blue, black)
 - 2 x CAT IV 1000 V test probes (red/black) for voltage measurement
 - 1 blue lead 0.5 m long with rear connection
 - 1 mains power cable 2 m long
 - DataView® software
 - 1 optical / USB communication cable
 - 1 CD-Rom containing the user manual

ACCESSORIES / REPLACEMENT PARTS

- 2 red/black test probes P01295454Z
- 3 crocodile clips (red/blue/black) P01103062
- See all the accessories on page 102



MULTIMETER CLAMPS FOR LEAKAGE CURRENT



F62 - F65

Ref. : P01120760 P01120761

10 μ A

10,000
counts

STRENGTHS

- Quick leakage-current testing
- Troubleshooting of insulation faults on live installations
- 50/60 Hz filter

CONTENTS

- F62 & F65 delivered with 1 shoulder bag
- 1 set of straight banana/elbowed banana leads
- 1 set of safety test probes
- 2 x 1.5 V LR03 batteries

ACCESSORIES / REPLACEMENT PARTS

- Red + black crocodile clips in blister pack (set of 2) [P01295457Z](#)
- Elbowed test-probe leads, 1.5 m (1 red /1 black) [P01295456Z](#)
- See all the accessories on page 102

SPECIFICATIONS

				F62	F65
Display				10,000 counts - 2 measurements / s	
Acquisition				AVG	TRMS
Function	Unit	Calibre	Resolution	Accuracy	
				with 50-60 Hz filter	with 50-60 Hz filter
Current	mA AC	60 mA	10 μ A	1.2% \pm 5 cts	2.5% \pm 5 cts 60 - 500 Hz
		600 mA	100 μ A		
	A AC	10 A	1 mA	1.2% \pm 5 cts	2.5% \pm 5 cts 60 - 500 Hz
		80 A	10 mA		
		100 A	10 mA	5% \pm 5 cts	5% \pm 5 cts (50-60 Hz)
Voltage	V AC	600 V	0.1 V	1.0% \pm 5 cts (50-60 Hz) 1.2% \pm 5 cts (60-500 Hz)	1.0% \pm 5 cts (50-60 Hz) 1.2% \pm 5 cts (60-500 Hz) 2.5% \pm 5 cts (500-3 kHz)
	V DC	600 V	0.1 V		1% \pm 2 cts
Resistance	Ω	1 k Ω	0.1 Ω		1% + 3 cts (VTest \leq 3.3 Vdc)
Audible continuity		Buzzer < 35 Ω			
Frequency	A	100 Hz 1 kHz	0.1 Hz 1 Hz	0.5% \pm 2 cts (I > 10 mA)	
	V	100 Hz 1 kHz	0.1 Hz 1 Hz	0.5% \pm 2 cts (V > 5 Vac)	
Max. value				100 ms	
Backlighting				Yes	
Deactivatable automatic power-off				Yes	
Clamping diameter				28 mm	
Dimensions / weight				218 x 64 x 30 mm / 280 g (with batteries)	
Standards				IEC 61010-1 / IEC 61010-2-032 / IEC 61010-2-033	
Installation category				300 V CAT III	
Enclosure protection rating				IP 30 as per EN 60529	



C.A 6421
page 80



C.A 6423
page 80



C.A 6460
page 81



C.A 6462
page 81

Type				
	Earth testers			
Earth				
3P method	■	■	■	■
4P method			■	■
Automatic coupling				
Selective earth				
Earth clamp				
4P + clamp method				
2-clamp method				
Pylon earth measurement				
Resistivity				
Manual			■	■
Automatic				
Contact voltage measurement				
Measurement of potential				
			■	■
Continuity				
Earth potential				
Measurement frequency				
Single frequency: 128 Hz	■	■	■	■
Single frequency: 2,083 Hz				
41 to 512 Hz				
41 to 5,078 Hz				
Measurement of Rs, Rh				
Measurement of Ustray				
Display				
Analogue	■			
LCD		■	■	■
3-display LCD				
OLED				
Storage / Communication				
Storage				
Communication				
Optical USB interface				
Bluetooth®				
Power supply				
Batteries	■	■	■	
Rechargeable batteries				■
PC / Tablet software				
GTT/ DataView®				
GTC				
Tablet application				



CHOOSE YOUR EARTH AND RESISTIVITY TESTER



C.A 6470N
TERCA 3
page 82



C.A 6471
page 83



C.A 6472
page 84



C.A 6416
page 86



C.A 6417
page 86

Type	Earth and resistivity testers			Earth testers	
Earth					
3P method	■	■	■		
4P method	■	■	■		
Automatic coupling	■	■	■		
Selective earth					
Earth clamp				■	■
4P + clamp method		■	■		
2-clamp method		■	■		
Pylon earth measurement*			■		
Resistivity					
Manual					
Automatic	■	■	■		
Contact voltage measurement				■	■
Measurement of potential	■	■	■		
Continuity	■	■	■		
Earth potential			■		
Measurement frequency					
Single frequency: 128 Hz					
Single frequency: 2,083 Hz				■	■
41 to 512 Hz	■	■			
41 to 5,078 Hz			■		
Measurement of Rs, Rh	■	■	■		
Measurement of Ustray	■	■	■		
Display					
Analogue					
LCD					
3-display LCD	■	■	■		
OLED				■	■
Storage / Communication					
Storage	■	■	■	■	■
Communication	■	■	■		■
Optical USB interface	■	■	■		
Bluetooth®					■
Power supply					
Batteries				■	■
Rechargeable batteries	■	■	■		
PC / Tablet software					
GTT/ DataView®	■	■	■		
GTC					■
Tablet application					■

*Used with the C.A 6474



C.A 6421 - C.A 6423

Ref. : P01123011

P01127013

**IP
54**

STRENGTHS

- 2-pole and 3-pole methods
- Simple to use
- Confirmation of the measurement by self-diagnosis
- Designed for use in the field with leakproof on-site casing and easy-to-read display

SPECIFICATIONS

	C.A 6421	C.A 6423
Measurement	Earth	
Type	2P & 3P	
Resistivity	No	
Measurement range	0.5 to 1,000 Ω	0.01 to 2,000 Ω (in 3 automatic calibres)
Resolution	-	10 mΩ / 100 mΩ / 1 Ω (depending on calibre)
Accuracy	± (5 % + 0.1 % at full scale)	± (2 % + 1 pt)
No-load voltage	≤ 24 V	≤ 48 V
Frequency	128 Hz	
Alarms	3 fault indicator LEDs	
Power supply	8 x 1.5 V LR06 batteries	
Display	Analogue	2,000-count digital LCD
Electrical safety	IEC 61010 & IEC 61557	
Dimensions / weight	238 x 136 x 150 mm / 1.3 kg	

CONTENTS

- C.A 6421 and C.A 6423 delivered with transport strap
- 8 x 1.5 V LR06 batteries

ACCESSORIES / REPLACEMENT PARTS

- Transport strap P01298005
- HRC fuse, 0.1 A - 250 V (x 10) P01297012
- See all the accessories on page 102



EARTH / RESISTIVITY / COUPLING TESTERS



C.A 6460 - C.A 6462

Ref. : P01126501 P01126502

IP
53

STRENGTHS

- 3-in-1 testers: resistivity, earth and coupling
- Validation of the measurement by self-diagnosis: 3 LEDs indicating the presence of faults liable to make the measurement result invalid
- Highly-resistant site-proof casing with lid for use in severe field conditions
- Large LCD display with backlighting

SPECIFICATIONS

	C.A 6460	C.A 6462
Measurement	Earth / resistivity / coupling	
Type	3P & 4P	
Measurement range	0.01 to 2,000 Ω (in 3 automatic calibres)	
Resolution	10 mΩ / 100 mΩ / 1 Ω (depending on calibre)	
Accuracy	± (2% + 1 ct)	
No-load voltage	≤ 42 V peak	
Frequency	128 Hz	
Alarms	3 fault indicator LEDs	
Power supply	8 x 1.5 V LR06 batteries	NiMH rechargeable battery
Display	2,000-count digital LCD	
Electrical safety	IEC 61010 & CEI 61557	
Dimensions	273 x 247 x 127 mm (handle folded away)	
Weight	2.8 kg	3.3 kg

CONTENTS

- C.A 6460 delivered with 8 x 1.5 V LR06 batteries
- C.A 6462 delivered with 1 mains lead for recharging

ACCESSORIES / REPLACEMENT PARTS

- European 2P mains lead P01295174
- HRC fuse, 0.1 A - 250 V (x 10) P01297012
- See all the accessories on page 102



EARTH / RESISTIVITY / COUPLING / CONTINUITY TESTER

C.A 6470N TERCA 3

Ref.: P01126506



STRENGTHS

- 4-in-1 tester: Earth / Resistivity / Coupling / Continuity
- Suitable for industry, housing and electricity companies

SPECIFICATIONS

	C.A 6470N
3P method	
Range (automatic selection)	0.01 Ω to 99.9 kΩ
Resolution	0.01 to 100 Ω
Test voltage	16 or 32 V, selectable
Measurement frequency	41 to 513 Hz, automatic or manual
Test current	Up to 250 mA
Accuracy	± 2 % of value ± 1 ct
4P method	
Range	0.001 Ω to 99.99 kΩ
Resolution	0.001 to 10 Ω
Test voltage	16 V or 32 V
Measurement frequency	41 to 513 Hz, automatic or manual
Test current	Up to 250 mA
Measurement accuracy	± 2 % of value ± 1 ct
Soil resistivity measurement - 4P method	
Measurement method	Wenner or Schlumberger method with automatic calculation of the results and display in Ω-metre
Range (automatic selection)	0.01 Ω to 99.99 kΩ
Resolution	0.01 Ω to 100 Ω
Test voltage	16 or 32 V, selectable
Measurement frequency	41 to 128 Hz
External voltage measurement	
Range (automatic selection)	0.1 to 65.0 V _{ac/dc} - DC and 15-440 Hz
Accuracy	± 2 % of value + 1 ct
Resistance / continuity measurement - earth connection test)	
Measurement type	2P or 4P method, selectable
Range (automatic selection)	2P : 0.01 Ω to 99.9 kΩ 4P : 0.001 Ω to 99.99 kΩ
Accuracy	± 2 % of value + 3 cts
Test voltage	16 V _{cc} (polarity +, - or auto)
Test current	> 200 mA for R < 20 Ω
Storage	
Memory capacity	512 test results
Communication	Optically-isolated USB
Power supply	Rechargeable battery
Charger power supply	External power supply with 18 V _{cc} / 1.5 A output or 12 V _{cc} vehicle power supply
Dimensions / weight	272 x 250 x 128 mm / 3.2 kg
Electrical safety	50 V CAT IV

CONTENTS

- C.A 6470N delivered with:
- 1 mains adapter
- 1 x 2-pole mains power cable for battery recharging on the mains
- Data export software
- 1 optical / USB communication cable
- 1 CD-Rom containing the user manual
- 5 specifications labels

ACCESSOIRES / RECHANGES

- DataView® report generation software P01102095
- Adapter for battery-charging on vehicle cigarette-lighter P01102036
- See all the accessories on page 102



EARTH / SELECTIVE EARTH / RESISTIVITY / COUPLING / CONTINUITY TESTER



C.A 6471

Ref. : P01126505



STRENGTHS

- 5-in-1 tester: Earth / Selective earth / Resistivity / Coupling / Continuity
- Ideal for industry and electricity companies

SPECIFICATIONS

C.A 6471	
Measurements with 2 clamps	
Range	0.01 to 500 Ω
Resolution	0.01 to 1 Ω
Measurement frequency	Auto : 1,611 Hz Manual : 128 Hz - 1,367 Hz - 1,611 Hz - 1,758 Hz
3P method	
Range (automatic selection)	0.01 Ω to 99.9 k Ω
Resolution	0.01 Ω to 100 Ω
Test voltage	16 V or 32 VRMS rated voltage, selectable
Measurement frequency	41 to 513 Hz, automatic or manual
Test current	Up to 250 mA
Accuracy	$\pm 2\%$ of value + 1 ct at 128 Hz
4P method / 4P+clamp measurement	
Range	0.001 Ω to 99.99 k Ω
Resolution	0.001 to 100 Ω
Test voltage	16 V or 32 V, selectable
Measurement frequency	41 to 513 Hz, automatic or manual
Test current	Up to 250 mA
Measurement accuracy	$\pm 2\%$ of value ± 1 ct
Soil resistivity measurement	
Measurement method	Wenner or Schlumberger method with automatic calculation of the results and display in Ω -metre
Range (automatic selection)	0.01 to 99.99 k Ω ; ρ max. 999 k Ω m
Resolution	0.01 Ω to 100 Ω
Test voltage	16 or 32 V, selectable
Measurement frequency	41 to 128 Hz, selectable
External voltage measurement	
Range (automatic selection)	0.1 to 65.0 V _{ac/bc} - DC and 15-440 Hz
Accuracy	$\pm 2\%$ of value + 1 ct
Resistance / Continuity measurement - (earth connection test)	
Measurement type	2P or 4P method, selectable
Range (automatic selection)	2P: 0.01 Ω to 99.9 k Ω ; 4P : 0.001 Ω to 99.99 k Ω
Accuracy	$\pm 2\%$ of value + 2 cts
Test voltage	16 V _{cc} (polarity +, - or auto)
Test current	> 200 mA for R < 20 Ω
Storage	
Memory capacity	512 test results
Communication	Optically-isolated USB
Power supply	Rechargeable battery
Charger power supply	External power supply with 18 V _{cc} / 1.9 A output or 12 V _{cc}
Dimensions / weight	272 x 250 x 128 mm / 3.2 kg
Electrical safety	50 V CAT IV

CONTENTS

- C.A 6471 delivered with:
 - 1 mains adapter
 - 1 x 2-pole main power cable for battery recharging on the mains
 - Data export software
 - 1 optical / USB communication cable
 - 2 x C182 clamps with 2 safety leads
 - 1 carrying bag
 - 1 CD-Rom containing the user manual
 - 5 specifications labels

ACCESSORIES / REPLACEMENT PARTS

- DataView® report generation software P01102095
- Adapter for battery recharging on vehicle cigarette lighter P01102036
- See all the accessories on page 102



EARTH / SELECTIVE EARTH / RESISTIVITY / COUPLING / CONTINUITY / PYLON EARTH TESTER



STRENGTHS

- All types of earth resistance measurement & pylon earth measurement (with the C.A 6474)
- Resistivity (Wenner + Schlumberger methods)
- Earth coupling
- Soil potential measurement
- Continuity / resistance

CONTENTS

- C.A 6472 delivered with:
 - 1 mains adapter
 - 1 x 2-pole mains power cable for battery recharging on the mains
 - Data export software
 - 1 optical / USB communication cable
 - 2 x C182 clamps with 2 safety leads
 - 1 carrying bag
 - 1 CD-Rom containing the user manual
 - 5 specifications labels

ACCESSORIES / REPLACEMENT PARTS

- DataView® report generation software P01102095
- Adapter for battery charging on vehicle cigarette lighter P01102036
- See all the accessories on page 102

C.A 6472

Ref. : P01126504



SPECIFICATIONS

	C.A 6472
3P measurements	
Range (automatic selection)	0.01 Ω to 99.9 kΩ
Resolution	0.01 Ω to 100 Ω
Test voltage	16 V or 32 VRMS rated voltage, selectable
Measurement frequency	41 to 5.078 Hz, automatic or manual
Test current	Up to 250 mA
Accuracy	± 2 % R + 1 ct at 128 Hz
Measurements with 2 clamps	
Range	0.01 to 500 Ω
Resolution	0.01 to 1 Ω
Measurement frequency	Auto: 1,611 Hz - Manual: 128 Hz - 1,367 Hz - 1,611 Hz - 1,758 Hz
4P method / 4P+clamp measurement	
Range	0.001 Ω to 99.99 kΩ
Resolution	0.001 to 10 Ω
Test voltage	16 V or 32 V, selectable
Measurement frequency	41 to 5,078 Hz, automatic or manual
Test current	Up to 250 mA
Measurement accuracy	± 2 % of value ± 1 ct
Soil resistivity measurement - 4P method	
Measurement method	Wenner or Schlumberger method with automatic calculation of the results and display in Ω-metre
Range (automatic selection)	0.01 to 99.99 kΩ ; ρ max. 999 kΩm
Resolution	0.01 Ω to 100 Ω
Test voltage	16 or 32 V, selectable
Measurement frequency	41 to 512 Hz, selectable
Earth potential measurement	
Measurement range	0.00 to 65.00 V
Resolution	0.01mV to 10 mV
Measurement frequency	41 to 5,078 Hz
Accuracy	± 5% + 1 ct at 128 Hz
External voltage measurement	
Range (automatic selection)	0.1 to 65.0 V _{ac/bc} - DC and 15-450 Hz
Accuracy	± 2 % of value + 1 ct
Resistance / Continuity measurement	
Measurement type	2P or 4P method, selectable
Range (automatic selection)	2P : 0.01 Ω to 99.9 kΩ 4P : 0.001 Ω to 99.99 kΩ
Accuracy	± 2 % of value + 2 cts
Test voltage	16 V _{bc} (polarity +, - or auto)
Test current	> 200 mA for R < 20 Ω
Storage	
Memory capacity	512 test results
Communication	Optically-isolated USB
Power supply	Rechargeable battery
Charger power supply	External power supply with 18 V _{bc} / 1.9 A output or 12 V _{bc} vehicle power supply
Dimensions / weight	272 x 250 x 128 mm / 3.2 kg
Electrical safety	50 V CAT IV



SPECIALLY FOR MEASUREMENTS ON PYLONS



C.A 6474

Ref.: P01126511

IP
53

STRENGTHS

- Used with the C.A 6472 for measurements on pylons
- Overall line impedance
- Pylon earth resistance
- Resistance of each pylon footing
- Quality of overhead earth wire connection

SPECIFICATIONS

C.A 6474 / PYLON BOX	
Measurements	Overall pylon earth resistance Earth resistance of each pylon footing Overall line impedance Quality of overhead earth wire connection. Active measurement (injection by the C.A 6472) Passive measurement (use of eddy currents)
Measurement type	
Range	0.067 Ω to 99.99 kΩ
Accuracy	± (5% + 1 ct)
Frequency	41 to 5,078 Hz
Frequency sweep	Yes
Dimensions	272 x 250 x 128 mm
Weight	2.3 kg
Power supply / Storage / Display	Provided by the C.A 6472

ADDITIONAL INFO

Possibility of connecting several AmpFlex® sensors in series for a length > 8 metres

The complete Pylon Earth Kit is available to order with the code P01299930. It comprises:

- C.A 6472
- C.A 6474
- 5 m AmpFlex®
- 100 m earth kit

For the 8 m AmpFlex® version of the complete pylon earth kit, order:

- C.A 6472 _____ P01126504
- C.A 6474 _____ P01126511
- 100 m earth kit _____ P01102024

CONTENTS

- C.A 6474 delivered with an accessories bag containing:
 - 1 connection cable
 - 6 BNC/BNC cables 15 m long
 - 4 AmpFlex® flexible current sensors 5 m long
 - 1 set of 12 identification rings for AmpFlex®
 - 2 cables (5 m green, 5 m black) with safety plugs on winder
 - 5 spade lug/Ø 4 mm banana plug adapters
 - 3 adjustable clamps
 - 1 calibration loop
 - 5 specifications labels

Available with 8 m AmpFlex® sensor

ACCESSORIES / REPLACEMENT PARTS

- Connection cable between the C.A 6472 and C.A 6474 _____ P01295271
- 15 m BNC/BNC cable _____ P01295272
- See all the accessories on page 102



C.A 6416 - C.A 6417

Ref.: P01122015

P01122016



SPECIFICATIONS

	C.A 6416	C.A 6417
Loop ohmmeter 1,500-count display	Measurement ranges (Ω) / Resolution (Ω) / Accuracy	
	0.010 to 0.099 / 0.001 / ±1.5 % ±0.01	
	0.10 to 0.99 / 0.01 / ±1.5 % ±2 r (r = resolution)	
	1.0 to 49.9 / 0.1 / ±1.5 % ±r	
	50.0 to 99.5 / 0.5 / ±2 % ±r	
	100 to 199 / 1 / ±3 % ±r	
	200 to 395 / 5 / ±5 % ±r	
	400 to 590 / 10 / ±10 % ±r	
	600 to 1,150 / 50 / Approx. 20 %	
	1,200 to 1,500 / 50 / Approx. 25 %	
Frequencies	Measurement frequency: 2,083 Hz Translation frequency: 50, 60, 128 or 2,083 Hz	
Loop inductance measurement	Measurement ranges (μH) / Resolution (μH) / Accuracy	
	10 to 100 / 1 / ±5 % ±r	
	100 to 500 / 1 / ±3 % ±r	
Contact voltage (calculated)	Measurement ranges (V) / Resolution (V) / Accuracy	
	0.1 to 4.9 / 0.1 / ±5 % ±r	
	5.0 to 49.5 / 0.5 / ±5 % ±r	
	50.0 to 75.0 / 1 / ±10 % ±r	
Ammeter 4,000-count display	Measurement ranges (A) / Resolution (A) / Accuracy	
	0.200 to 0.999 mA / 1 μA / ±2 % ±50 μA	
	1.000 to 2.990 mA - 3.00 to 9.99 mA / 10 μA / ±2 % ±50 μA	
	10.00 to 29.90 mA - 30.0 to 99.9 mA / 100 μA / ±2 % ±r	
	100.0 to 299.0 mA - 0.300 to 0.990 A / 1 mA / ±2 % ±r	
	1.000 to 2.990 A - 3.00 to 39.99 A / 10 mA / ±2 % ±r	
Setup		
Modes	Standard or advanced	
Alarms	Configurable on Z, V and A	
Buzzer	Active / Inactive	
HOLD	Manual or automatic PRE-HOLD	
Automatic power-off	Active / Inactive	
General specifications		
Display	152-segment OLED. Active area: 48 x 39 mm	
Max. clamping diam.	Ø 35 mm	
Storage	300 time/date-stamped measurements	2,000 time/date-stamped measurements
Communication	Bluetooth® Class 2	
Power supply	4 x 1.5 V LR06 alkaline batteries or 4 x Ni-MH rechargeable batteries	
Battery life	1,440 x 30-second measurements	
Calibration	Automatic at startup	
Electrical safety	IEC 61010 600 V CAT IV	
Ingress protection	IP40	
Dimension / weight	55 x 95 x 262 mm / Approx. 935 g with batteries	

STRENGTHS

- Quick earth-loop testing
- OLED screen and force compensation system
- Simultaneous display of Ω and A
- Contact voltage alarm

ADDITIONAL INFO

- Automatic measurement HOLD when the clamp is opened
- Android application downloadable from Google Play

CONTENTS

- 1 clamp delivered in a shoulder bag
- 4 x 1.5 V LR06 batteries
- 1 verification certificate
- 1 CD-ROM containing the user manual
- The C.A 6417 is delivered with the simplified GTC driver as well

ACCESSORIES / REPLACEMENT PARTS

- Bluetooth USB modem P01102112
- CL1 calibration loop P01122301
- See all the accessories on page 102



CHOOSE YOUR ELECTRICAL EQUIPMENT TESTER



C.A 6121
page 88



C.A 6160
page 89



C.A 6155
page 90

Insulation			
250 V _{DC}		■	■
500 V _{DC}	■	■	■
1,000 V _{DC}	■	■	
Dielectric tests			
1,000 / 1,250 / 1,500 V _{AC}	■		
1,000 / 1,890 / 2,500 V _{AC}			■
100 to 5,000 V _{AC}		■	
Continuity			
I test > 10 A	■	■	■
I test 0.2 A		■	■
I test 0.1 A		■	
I test 25 A		■	
Voltage drop			
I test 10 A	■	■	
Via Zi			■
Discharge time			
Discharge time at 60 V	■	■	■
Leakage current			
Via socket		■	■
Substitution method (residual)		■	■
Contact leakage current		■	■
Direct method via clamp			■
Functional testing			
Apparent power S, voltage V		■	■
Active power, current, frequency & cos φ		■	
Loop impedance & loop resistance			
Zs-loop (L-PE) (Trip), Calculation of I _k (PFC)			■
Zs-loop (L-PE) (No Trip), Calculation of I _k (PFC)			■
Zi-loop (L-N or LL), Calculation of I _{sc} (PSCC)			■
RCD & PRCD testing			
PRCD x 0.5 / x 1 / x 5x I _{Δn}			■
RCD x 0.5 / x 1 / x 2 / x 5x I _{Δn}			■
Other functions			
Alarms	■	■	■
Phase sequence			■
Storage / communication			
Storage	■ (999)	■ (1600)	■ (6000)
RS232 / USB communication	■	■	■ ■
Transmission of results to printer	■	■	■
Interface for pedal (START/STOP, SAVE) and lamps	■	■	
Interface for barcode		■	■
DOOR OPEN interface		■	
PC software			
	MachineLink	CELink	CALink



C.A 6121

Ref.: P01145601

600 V
CAT III

IP
40

STRENGTHS

- Insulation
- Dielectric test
- Continuity
- Voltage drop
- Discharge time

SPECIFICATIONS

		C.A 6121
Insulation	Test voltage	500 / 1,000 V _{oc}
	Measurement range	1 kΩ to 500 MΩ
	Accuracy 0 to 200 MΩ	± (2 % R + 2 cts)
Dielectric tests	Test voltage	1,000 / 1,250 / 1,500 V _{Ac} (50 Hz) for U _{mains} = 230 V and at 500 VA
	Measurement range	0 to 500 mA
	Accuracy	± (2 % R + 0.3 mA) For trigger current set to 1, 3, 5, 10 or 20 mA ± (2 % R + 0.5 mA) For trigger current set to 30, 40, 50, 60, 70, 80, 90 or 100 mA ± (2 % R + 2 mA) For trigger current set to 150, 200, 250, 300, 330, 350, 400, 450 or 500 mA
Continuity	Range	0 to 2 Ω
	Measurement current	I > 10 A
	Accuracy 0 to 1 Ω	± (2 % R + 2 mΩ)
Voltage drop	Test current	10 A
	Measurement range	0 to 10 V
	Accuracy	± (2 % R + 0.02 V)
Discharge time		External (2 cts) or internal (4 cts)
	Range	0 - 10 s
	Accuracy	± (2 % R + 0.2 s)
Storage		999 measurements
Communication output		RS232
Power supply		230 V / 50 Hz mains supply
Dimensions / weight		400 x 260 x 250 mm / 11 kg
Electrical safety		IEC 61010-1 - 600 V CAT III

CONTENTS

C.A 6121

- 1 accessories bag
- 2 dielectric test guns with 2 m cable
- 2 continuity test leads 2.5 m long (1 red, 1 black)
- 2 insulation test leads 3 m long (1 red, 1 black)
- 2 crocodile clips (1 red, 1 black)
- 1 red test probe
- 1 discharge-time cable
- 1 power supply cable

ACCESSORIES / REPLACEMENT PARTS

- Machine Link Windows processing software (supplied with communication cable) P01101915
- Series printer no. 5 P01102903
- See all the accessories on page 102



C.A 6160

Ref.: P01145801

300 V CAT III	IP 50
------------------	----------

STRENGTHS

- Insulation
- Dielectric test
- Continuity
- Voltage drop
- Discharge time
- Leakage current

SPECIFICATIONS

	C.A 6160
Insulation	
Test voltage	250 / 500 / 1,000 Vdc
Measurement range	0.000 MΩ to 999 MΩ
Accuracy	0.000 to 1.999 MΩ: ±(5 % R + 10 cts) 2.000 to 199.9 MΩ: ±(3 % R + 3 cts) 200 to 999 MΩ: ±(10 % R + 10 cts)
Dielectric test	
Test voltage	100 to 5,000 V _{ac} - 50 Hz/60 Hz for U _{mains} = 230 V at 500 VA
Trigger current	0.5 to 500 mA up to 500 VA
Continuity	
Test current	0.1 / 0.2 / 10 / 25 A
Measurement range	0.000 to 9.999 Ω for I = 10 A or 25 A 0.00 to 100.0 Ω for I = 0.1 A
Accuracy at 10 / 25 A	(3 % R + 3 cts)
Voltage drop	0.00 to 99.99 V at 10 A
Discharge time	External (at mains socket) Internal (components)
Leakage current	
Measurement range	0.00 to 20.0 mA
Accuracy	±(5 % R + 3 cts)
Residual leakage current	
Measurement range	0.00 to 20.0 mA
Accuracy	±(5 % R + 3 cts)
Contact leakage current	
Measurement range	0.00 to 2.00 mA
Accuracy	±(5 % R + 3 cts)
Functional testing	Active power, apparent power, current, voltage, frequency, cos φ
Storage	1,600 measurements
Communication output	RS232
Power supply	Mains 230 V / 50-60 Hz
Dimensions / weight	410 x 175 x 370 mm / 13.5 kg
Ingress protection	IP 50: closed product
Electrical safety	IEC 61010-1 - 600 V CAT II - 300 V CAT III

ADDITIONAL INFO

- AUTOTEST function for automatic execution of a measurement sequence
- Storage of up to 1,600 measurements
- Checking and certification according to the European standards

CONTENTS

- C.A 6160
- 1 bag
- 2 dielectric test guns with 2 m cable
- 2 insulation test leads 3 m long
- 4 crocodile clips
- 2 test probes
- 4 continuity test leads 2.5 m long
- 1 discharge-time cable
- 1 power supply cable

ACCESSORIES / REPLACEMENT PARTS

- CE- LINK processing software P01101996
- DB9F-DB25M adapter P01101841
- See all the accessories on page 102

CE Link software (option) for C.A 6160

- download the recorded data
- create measurement sequences and upload them into the instrument
- perform tests remotely and recover the data directly in the software
- create and print measurement reports



C.A 6155

Ref. : P01146001

SPECIFICATIONS

300 V
CAT III

IP
50



STRENGTHS

- Integration of all the measurements required by the new editions of the IEC 60204 (edition5), VDE0701/0702 and IEC 61439 (ex-IEC 60439) standards
- Preprogrammed test sequences based on the standards or customizable
- Extended memory, up to 6,000 measurements stored

ADDITIONAL INFO

- Large backlit graphical display with an intuitive user interface
- Contextual help for each function
- Built-in keypad for quick, simple customization of the measurements recorded
- Possibility of connecting a barcode reader

CONTENTS

- C.A 6155
- 1 accessories bag containing 1 high-voltage test probe
- 1 test cable for mains power socket
- 1 test cable with separated wires
- 1 red lead 1.5 m long
- 1 black lead 1.5 m long
- 1 green lead 1.5 m long
- 1 red lead 4 m long
- 4 test probes
- 3 crocodile clips
- 1 USB communication cable
- 1 RS232 communication cable
- CALink data transfer software

		C.A 6155
Dielectric test	Test voltage	1,000 V / 1,890 V / 2,500 V
	I limit	0.1 to 100 mA (1,890 V / 2,500 V) 0.1 to 200 mA (1,000 V)
	Timer	2, 3, 5, 10, 30 s
Insulation resistance measurement	U test	250 / 500 V _{bc}
	Range	up to 200 MΩ
	Timer	5, 10, 30, 60, 120 s
Continuity test	Range	0.01 to 1.99 Ω - Indication range: 2.00 Ω to 19.9 Ω
	I test	0.20 / 10 A
	U test	< 9 V
	Timer	5, 10, 30, 60, 120, 180 s
Leakage current measurement	Substitution method	0.00 to 20.0 mA
	Differential method	0.00 to 9.99 mA
	Accuracy	± (5 % R + 5 cts)
Contact leakage current measurement	Measurement range	0.00 to 2.50 mA
	Accuracy	± (10 % R + 5 cts)
Measurement of 60 V / 120 V discharge time		10 % R
Voltage range (peak value)		0 to 550 V
Time range		0 to 10 s
Functional testing	Apparent power	0.00 to 4.00 kVA
Power-cable polarity test		Yes
Current measurement with clamp		0.00 mA to 24.9 A
PRCD test	Calibre	10, 15, 30 mA
	Test current	0,5 x IΔn, IΔn, 5 x IΔn
	Other	Automatic PRCD test
RCD test	Calibre	10, 30, 100, 300, 500, 1,000 mA
	Test current	0,5 x IΔn, IΔn, 2 x IΔn, 5 x IΔn
	Current range	AC / AC (pulsed) / DC
	Type of RCD	General / Selective
	Type of test	Ramp / Pulse
	Uc contact voltage measurement	Yes
	Other	Automatic RCD test
High-current Zs loop measurement	Measurement current	6.5 A
	Range	0.00 to 1,999 Ω
	Accuracy	±(5 % R + 5 digits)
	Calculation of I _k	0.00 to 23.0 kA
Zs loop measurement (no RCD trip)	Range	0.00 to 1,999 Ω
	Accuracy	±(5 % R + 10 digits)
	Calculation of I _k	0.00 to 23.0 kA
Zi loop measurement	Measurement current	6.5 A
	Range	0.00 to 1,999 Ω
	Accuracy	±(5 % R + 5 digits)
Voltage / frequency	Calculation of I _k	0.00 to 199 kA
	Measurement current	6.5 A
Phase rotation	Range	0.00 to 1,999 Ω
	Accuracy	±(5 % R + 5 digits)
Communication	Calculation of I _k	0.00 to 199 kA
	Measurement current	6.5 A
Alarms	Voltage / frequency	0 to 550 V / DC, 14.0 to 499.9 Hz
	Phase rotation	Voltage 100 to 550 V AC Frequency 14 to 500 Hz
Storage	Communication	RS 232 1 barcode/ RFID reader connection + 1 printer / PC connection
	Alarms	USB 1 printer / PC connection
Software	Alarms	Yes for all functions
	Storage	6,000 memory locations
Power supply	Software	Yes, delivered as standard, Pro version available as an option
	Power supply	230 V / 50-60 Hz
Dimensions / weight		33.5 cm × 16.0 cm × 33.5 cm / 8.4 kg
Functional standards		VDE 701 702 / IEC 60204 Ed.5 / IEC 60439 / IEC 61439
Electrical safety		IEC 61010-1 / IEC 61557 (parts 1, 2, 3, 4, 6, 7, 10) 300 V CAT II, 300 V CAT III (TP1)
Ingress protection		IP 50: closed product



MICRO-OHMMETERS

C.A 6240
page 93

C.A 6250
page 94

C.A 6292
page 95

4-wire measurement method (Kelvin)	■	■	■
Measurement range	400 Ω	2,500 Ω	1 Ω
Resolution	1 $\mu\Omega$	0.1 $\mu\Omega$	0.1 $\mu\Omega$
Measurement current	10 A / 1 A / 100 mA / 10 mA	10 A / 1 A / 100 mA / 10 mA / 1 mA	Automatic 50 / 100 / 150 and 200 A Manual from 20 to 200 A
Inductive mode	Normal	Inductive, non-inductive, auto non-inductive	Normal / BSG* = Both Sides Grounded
Alarms		■	
Temperature compensation		■	
USB / RS232 communication	■		■
Memory (number of measurements)	100	1500	8000
Automatic recording	■		■
Power supply	NiMH batteries	NiMH batteries	Mains

*BSG = Both Sides Grounded



RATIOMETERS

DTR 8510
page 96

Range of VT/PT ratios	0.8000 to 8,000 / 1
Range of CT ratios	0.8000 to 1,000 / 1
Power supply	up to 10 hours
Memory	10,000 tests
Communication	Optical USB



PHASE ROTATION AND/OR MOTOR TESTERS



C.A 6608
page 97



C.A 6609
page 97

Operating mode	With connection	Avec et sans connexion
Operating voltage with connection	40 to 850 VAC between phases	40 to 600 VAC between phases
Operating voltage without connection		120 to 400 VAC between phases
Power supply	Via the measurement	9 V battery

CABLE AND METAL CONDUCTOR LOCATOR



C.A 6681 E/R
page 98

- Operation with/without voltage
- Location of a short-circuit / circuit break
- Location of cables, conductors or metal pipes

■	■
■	■
	■

BATTERY CAPACITY TESTERS



C.A 6630
page 99

Min / max measurement range	40 mΩ / 40 Ω
Min / max resolution	10 μΩ / 10 mΩ
Measurement frequency	1 kHz
Comparison function	99 sets of settings
Manual storage (number of locations)	999
Automatic storage (number of locations)	9,600



C.A 6240

Ref.: P01143200



STRENGTHS

- 4-wire measurement method
- Automatic current reversal
- Test current up to 10 A
- 1 $\mu\Omega$ resolution
- Automatic recording "on the fly" or manual recording

SPECIFICATIONS

	C.A 6240					
Measurement method	4-wire method					
Range	4,000 $\mu\Omega$	40 m Ω	400 m Ω	4,000 m Ω	40 Ω	400 Ω
Accuracy	0.25% ± 2 cts	0.25% ± 2 cts	0.25% ± 2 cts	0.25% ± 2 cts	0.25% ± 2 cts	0.25% ± 2 cts
Resolution	1 $\mu\Omega$	10 $\mu\Omega$	0.1 m Ω	1 m Ω	10 m Ω	100 m Ω
Measurement current	10 A	1 A	1 A	100 mA	10 mA	10 mA
Memory	100 measurements					
Communication output	Optical / USB link					
Power supply	Rechargeable NiMH battery					
Dimensions / weight	273 x 247 x 280 mm / 5 kg					
Electrical safety	IEC 61010 - 50 V CAT III					

ADDITIONAL INFO

- The C.A 6240 is compatible with the DataView® software

CONTENTS

- C.A 6240
- 1 shoulder bag
- 1 set of 2 x 10 A Kelvin clamps with 3 m cable
- 1 European 2P mains power cable
- Data export software
- 1 optical / USB communication cable

ACCESSORIES / REPLACEMENT PARTS

- Double 1 A test probes (x 2) _____ P01102056
- Mini Kelvin clamp (set of 2) _____ P01101783
- See all the accessories on page 102



C.A 6250

Ref.: P01143201

50 V
CAT III

IP
53

STRENGTHS

- 4-wire measurement method
- Automatic compensation of stray currents
- Test current up to 10 A
- 0.1 $\mu\Omega$ resolution
- Integrated "temperature compensation" function

SPECIFICATIONS

	C.A 6250							
Measurement method	4-wire method							
	Range	5,000 m Ω	25,000 m Ω	250,00 m Ω	2500,0 m Ω	25,000 Ω	250,00 Ω	2500,0 Ω
Accuracy	0.05 % +1.0 $\mu\Omega$	0.05 % +3 $\mu\Omega$	0.05 % +30 $\mu\Omega$	0.05 % +0.3 m Ω	0.05 % +3 m Ω	0.05 % +30 m Ω	0.05 % +300 m Ω	
Resolution	0.1 $\mu\Omega$	1 $\mu\Omega$	10 $\mu\Omega$	0.1 m Ω	1 m Ω	10 m Ω	100 m Ω	
Measurement current	10 A	10 A	10 A	1 A	100 mA	10 mA	1 mA	
Measurement modes	Inductive, non-inductive, non-inductive with automatic trigger							
Temperature compensation	By temperature sensor or manual							
Memory	1500 measurements							
Communication output	RS232 link							
Power supply	Rechargeable NiMH battery							
Dimensions	270 x 250 x 180 mm / 4 kg							
Electrical safety	IEC 61010 - CAT III 50 V							

ADDITIONAL INFO

- The C.A 6250 is compatible with the DataView® software
- Possibility of connecting the Pt100 sensor (option) directly to the instrument

CONTENTS

- C.A 6250
- 1 shoulder bag with 1 power cable 2 m long
- 1 set of 2 x 10 A Kelvin clamps with 3 m cables
- Data export software
- 1 RS 232 communication cable

ACCESSORIES / REPLACEMENT PARTS

- Doubles 1 A test probes (x 2) _____ P01102056
- Mini Kelvin clamp (set of 2) _____ P01101783
- See all the accessories on page 102



C.A 6292

Ref.: P01143300



STRENGTHS

- Permanent test at 100 A and for up to 120 s at 200 A
- Test current up to 200 A
- Resistance from 0.1 $\mu\Omega$ to 1 Ω
- Safe measurements: BSG method (Both Sides Grounded)
- Storage of up to 8,000 measurement results

SPECIFICATIONS

C.A 6292	
Test current	Programmable from 20 to 200 A
Resistance	0.1 $\mu\Omega$ to 2 m Ω 2 to 200 m Ω 200 m Ω to 1 Ω
Resolution	0.1 $\mu\Omega$ (200 A max) 10 $\mu\Omega$ (25 A max to 200 m Ω) 1 m Ω (5 A max to 1 Ω)
Accuracy	$\pm 1\%$ from 50 $\mu\Omega$ to 1 Ω
Output voltage	110 VAC : 4.2 V @ 200 A 220 VAC : 8.6 V @ 200 A
Maximum load resistance	110 VAC : 20 m Ω @ 200 A 220 VAC : 42 m Ω @ 200 A
Measurement method	4 Kelvin-type connection terminals
Test mode	Normal or BSG
Test duration	Adjustable from 5 to 120 s @200 A, unlimited below 100 A
Storage	Up to 8,000 measurement results
Interface	USB 2.0
Software	DataView®
Power supply	100 to 240 VAC - 50/60 Hz
Dimensions	502 x 394 x 190 mm
Weight	13 kg approx.
Operating temperature	0 °C to +55 °C
Storage temperature	-10 °C to +70 °C
Humidity	95% RH
Protection	Protected against voltage surges, short-circuits, overheating and overvoltage on the safety terminals
Ingress protection	IP54
Electrical safety	IEC 61010-1
Consumption	1,500 VA max.
Current measurement with the optional MR6292 clamp	
Measurement range	1.0 - 50.0 A _{ac}
Resolution	0.1 mA
Intrinsic uncertainty	$\pm (1.5\% + 2 \text{ cts})$
Output signal	10 mV / A _{ac}
Load impedance	> 100 k Ω // 100 pF
Influence of conductor position in jaws	0.50 %

ADDITIONAL INFO

- The backlit LCD screen with its 4 lines of 20 characters is easy to read whatever the environment.

CONTENTS

- C.A 6292 delivered with a hard case containing:
 - 1 set of 2 Kelvin leads 6 m long (red / black) with adjustable-clamp connections
 - 1 green earth lead 3m long with 1 crocodile clip
 - 1 USB cable 1.5 m long
 - 1 T1 5 A 250 V fuse mounted in the instrument
 - 1 European mains power lead
 - 1 CD-ROM containing the DataView® software
 - 1 CD-ROM containing the user manual in 5 languages

ACCESSORIES / REPLACEMENT PARTS

- 1 set of 2 Kelvin leads 6 m long (red / black) adjustable-clamp connections P01295486
- 1 green earth lead with crocodile clip P01295488
- See all the accessories on page 102



DTR 8510

Ref.: P01157702



STRENGTHS

- Measurement of the transformation ratio of power, voltage and current transformers
- Storage of up to 10,000 measurement results
- Displays the transformation ratio, the excitation current, the winding polarity and the percentage deviation from the rated values
- Direct reading of the transformation ratio from 0.8000:1 and up to 8000.0:1
- Tests performed by excitation of the primary with measurement on the secondary

SPECIFICATIONS

DTR 8510											
Range of ratios (VT/PT)	Automatic: 0.8000 to 8000:1										
Accuracy (VT/PT)	<table border="1"> <tr> <th>Range of ratios</th> <th>Accuracy (% of reading)</th> </tr> <tr> <td>0.8000 to 9.9999</td> <td>± 0.2 %</td> </tr> <tr> <td>10.000 to 999.99</td> <td>± 0.1 %</td> </tr> <tr> <td>1000.0 to 4999.9</td> <td>± 0.2 %</td> </tr> <tr> <td>5000.0 to 8000.0</td> <td>± 0.25 %</td> </tr> </table>	Range of ratios	Accuracy (% of reading)	0.8000 to 9.9999	± 0.2 %	10.000 to 999.99	± 0.1 %	1000.0 to 4999.9	± 0.2 %	5000.0 to 8000.0	± 0.25 %
Range of ratios	Accuracy (% of reading)										
0.8000 to 9.9999	± 0.2 %										
10.000 to 999.99	± 0.1 %										
1000.0 to 4999.9	± 0.2 %										
5000.0 to 8000.0	± 0.25 %										
Range of ratios (CT)	Autoranging: 0.8000 to 1000.0										
Accuracy (CT)	± 0.5 % of reading										
Excitation signal	VT/PT mode: 32 Vrms max CT mode: auto-level 0 to 1 A, 0.1 to 4.5 Vrms										
Display of excitation current	Range: 0 to 1,000 mA; Accuracy: ± (2 % of reading + 2 mA)										
Excitation frequency	70 Hz										
Display	Alphanumeric LCD, 2 lines of 16 characters with adjustment of the contrast and backlighting. Easy to read in both day and night conditions										
Languages available	French, English, Spanish, Italian, German, Portuguese										
Measurement method	As per IEEE Std C57.12.90™										
Power supply	Two 12 V rechargeable NiMH batteries, 1,650 mAh										
Battery life	Up to 10 hours in continuous operation; low-battery alert										
Battery charger	Universal input (90 to 264 Vrms), smart charger										
Charging time	< 4 hours for full charge										
Memory	10,000 tests										
Date / time	Powered by dedicated battery, real-time clock										
Communication	USB 2.0, optical isolation, 115.2 kB										
Software	Delivered with the DataView® analysis software										
Dimensions / weight	272 x 248 x 130 mm / 3.7 kg										
Connection	XLR connectors										
Cables	Shielded H and X cables 4.6 m (15 ft) long, equipped with colour-coded crocodile clips										
Casing	Rugged polypropylene casing, UL 90 V0										
Vibrations	IEC 68-2-6 (1.5 mm at 55 Hz)										
Shocks	IEC 68-2-27 (30 G)										
Falls	IEC 68-2-32 (1 m)										
Ingress protection	IP 40 with lid open as per EN 60529 IP 53 with lid closed as per EN 60529										
Safety	EN 61010-1, 50 V CAT IV; pollution degree 2										

ADDITIONAL INFO

- Up to 10 hours' continuous operation thanks to the rechargeable NiMH batteries

CONTENTS

- DTR 8510
- 1 shoulder bag
- 1 set of leads 4.6 m long with crocodile clips
- 1 external battery charger with mains lead
- 1 USB cable
- 1 NiMH battery datasheet
- DataView software on CD-Rom

ACCESSORIES / REPLACEMENT PARTS

- Set of 2 leads 4.6 m long P01295143A
- USB cable P01295293
- See all the accessories on page 102



PHASE ROTATION AND/OR MOTOR TESTERS



C.A 6608, C.A 6609

Ref. : P01191304

P01191305

600 V
CAT IIIIP
40

STRENGTHS

- Indication of phase presence or absence
- Determination of a motor's rotation direction with or without contact (C.A 6609 only)
- Automatic tests as soon as the connections have been set up
- Terminals and cables identified by colour coding to simplify connection

SPECIFICATIONS

	C.A 6608	C.A 6609
Operating voltage for phase rotation function	40 to 850 V _{AC} between phases	With connection: 40 to 600 V _{AC} between phases Without connection: 120 to 400 V _{AC} between phases
Frequency range	15 to 400 Hz	
Power supply	Self-powered via measurement inputs	9 V battery
Dimensions	130 x 69 x 32 mm	
Weight	130 g	170 g
Electrical safety	IEC 61010-1 600 V CAT III IEC 61557-7	

CONTENTS

- **C.A 6608** phase rotation testers delivered in a shoulder bag with:
 - 3 test leads
 - 3 crocodile clips
- **C.A 6609** phase rotation and motor tester delivered in a shoulder bag with:
 - 3 test leads
 - 3 crocodile clips



C.A 6681

Ref. : P01141626

STRENGTHS

- Can be used on live or non-current-carrying installations
- Digital, visual and audible indication to track the conductor intuitively
- Large LCD screen with indication of the transmission power, the digital identification code and the voltage present on the circuit tested.

SPECIFICATIONS

	C.A 6681 E
Transmitted signal frequency	125 kHz
External voltage measurement	12~300 V DC/AC(50~60 Hz)
Dimensions	190 × 89 × 42.5 mm
Weight	420 g approx. with battery

	C.A 6681 R
Detection depth	Single-pole application: 0 to 2 m approx. Two-pole application: 0 to 0.5 m approx. Simple looping line: up to 2.5 m
Identification of network voltage	0~0.4 m approx.
Dimensions	241.5 × 78 × 38.5 mm
Weight	360 g approx. with battery

ADDITIONAL INFO

- Automatic or manual adjustment of signal reception sensitivity
- The transmitter and receiver units are equipped with:
 - A battery status indicator
 - An additional lighting system (torch) for use in dark environments

ACCESSORIES / REPLACEMENT PARTS

- 33 m reel of green wire with battery clip/4 mm male banana on winder with handle P01295268
- 15 m reel of green wire with battery clip/4 mm male banana on H winder with 1 stake P01102019
- See all the accessories on page 102

CONTENU

- 1 hard case containing 1 C.A 6681E transmitter
- 1 C.A 6681R receiver
- 1 set of 2 red/black leads, straight male isolated Ø 4 mm banana / elbowed male isolated Ø 4 mm banana, 1.5 m long
- 1 set of 2 red/black crocodile clips
- 1 earthing stake
- 1 adapter for mains power socket
- 1 male plug adapter for B22 bayonet socket
- 1 male plug adapter for E27 screw socket
- 1 x 9 V 6LR61 battery
- 6 x 1.5 V LR03 batteries



BATTERY CAPACITY TESTERS

BATTERY CAPACITY TESTERS



C.A 6630

Ref.: P01191303

STRENGTHS

- Zero adjustment function for compensation of the voltage circuit displayed
- 2-display LCD screen
- 7-hour battery life in continuous operation with 6 x 1.5 V batteries (not supplied)
- Capacity test from 35 Ah to 500 Ah
- Lead and AGM batteries

SPECIFICATIONS

		C.A 6630			
Resistance measurement					
Range		40 mΩ	400 mΩ	4 Ω	40 Ω
Resolution		10 μΩ	100 μΩ	1 mΩ	10 mΩ
Measurement current		37.5 mA	3.75 mA	375 μA	37.5 μA
Accuracy		± (1 % R + 8 digits) Temp. coeff.: ± (0.1 % R + 0.5 digit) / °C			
Measurement voltage		1.5 mV _{AC}			
Measurement frequency		1 kHz ± 10 %			
Voltage measurement					
Range		4 V		40 V	
Resolution		1 mV		10 mV	
Accuracy		± (0.1 % R + 6 digits)			
Max. consumed power		1 VA			
Mechanical specifications					
Dimensions		250 x 100 x 45 mm			
Weight		500 g including batteries			

CONTENTS

- 1 hard case containing:
 - C.A 6630
- 1 set of 2 measurement leads 1 m long terminated by retractable test probes
- PC data transfer software to export and process the stored data
- 1 C.A 6630 / PC connection cable

ACCESSORIES / REPLACEMENT PARTS

- Set of 2 leads with retractable test probes _____ P01102103
- See all the accessories on page 102



DATAVIEW®

Réf. : P01102095

ICT MEG GTT GTC MOT DTR

FUNCTIONS

- Configuration of all the functions of instruments connected to a PC or via Bluetooth®
- Recovery of the recorded measurement data
- Backup of measurement files
- Opening of saved files
- Processing and creation of reports
- Export into an Excel spreadsheet
- Export in .pdf format
- Database management
- Remote test activation by simply pressing a button
- Data capture and display in real time
- Display of DAR, PI and DD ratios
- Graphical plotting of programmed-duration tests and voltage ramp tests in real time
- Possibility of creating a library of configurations for specific applications
- Printing of measurement reports

ICT REPORTS ACCORDING TO THE APPLICABLE STANDARDS

The ICT module of DataView® proposes to **define the tree-structure** which will be used during the actual test campaign (sites, parts, objects), as well as the tests to be performed for each of them. Once defined in this way, the campaign can be recorded in the instrument via the communication link. This **saves significant time in the field.**

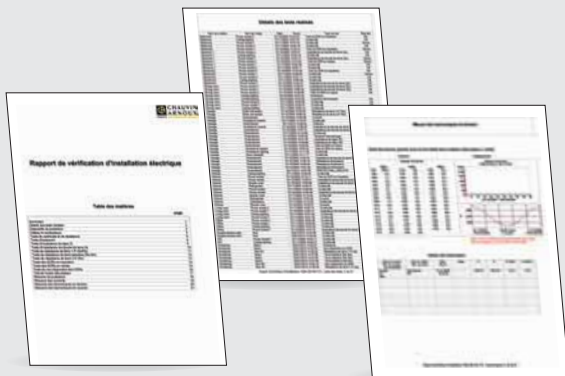

REQUIRED CONFIGURATION

- Windows XP / 256MB of RAM
- Windows Vista & Windows 7/8/10 (32/64 bit)
- 1 GB of RAM for Windows Vista & Windows 7/8 (32 bit)
- 2 GB of RAM for Windows Vista & Windows 7/8 (64 bit)
- 80 MB available space on hard disk (200 MB recommended)

ADDITIONAL INFO

- The DataView® software:
 - Automatically recognizes the instrument connected when it is hooked up to the PC and opens the corresponding menu. Users then have direct access to the configuration and the recorded data
 - Is equipped with a large number of predefined report templates for quick generation in compliance with the applicable standards. Users can also create their own templates, as required, and directly add their own comments.

DataView® Modules	ICT	MEG	GTT	GTC	MOT	DTR
Associated products	C.A 6116N	C.A 6543	C.A 6470N	C.A 6417	C.A 6240	DTR 8510
	C.A 6117	C.A 6547	C.A 6471		C.A 6250	
		C.A 6549	C.A 6472		C.A 6292	
		C.A 6550	C.A 6474			
		C.A 6555				
		C.A 6526				
		C.A 6532				
	C.A 6534					



DATA PROCESSING SOFTWARE

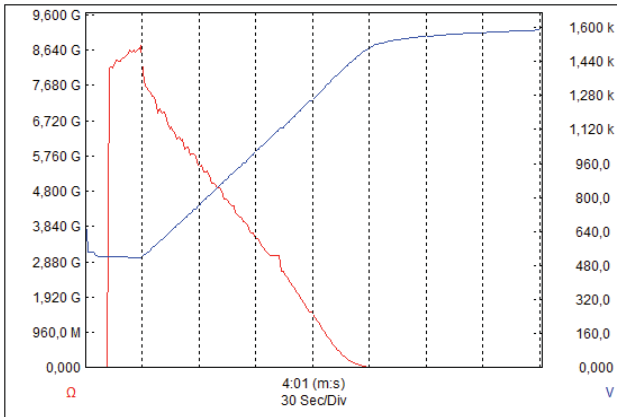

MEG MODULE Graphical plotting of the V(t) and R(t) tests on a non-linear insulation resistance (surge suppressor)

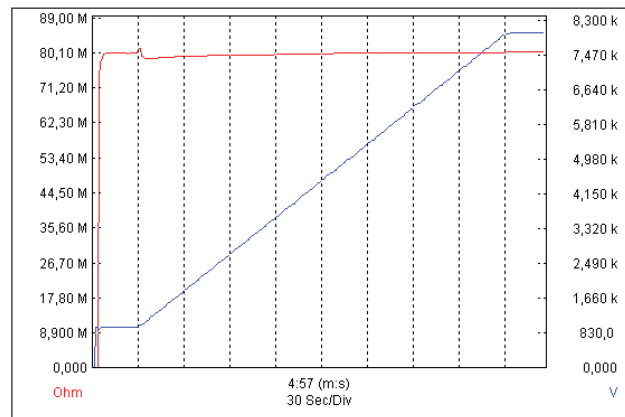

MEG MODULE Graphical plotting of the V(t) and R(t) tests on a fixed insulation resistance

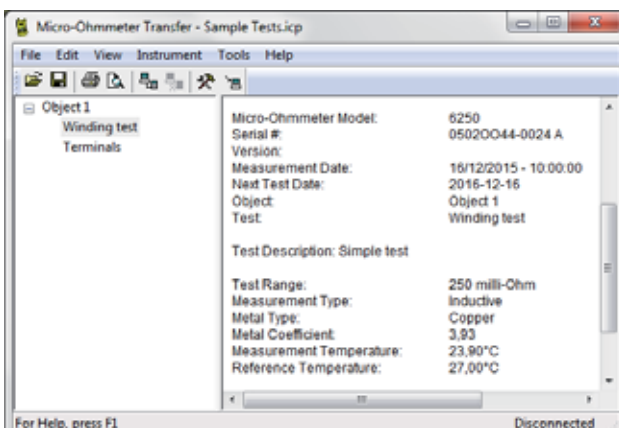

MOT MODULE Results of motor winding test



GTT MODULE Example of configuration

Measurement Date	Test	Test type	Filter	Turns ratio	Deviation	Current	Primary	Secondary
28/01/2011 - 14:37:35	Test 1	CT	Normal	1,0006:1	N/A	0 mA	19920 A	7200 A
28/01/2011 - 14:38:05	Test 2	CT	Normal	2,4999:1	N/A	0 mA	19920 A	7200 A
28/01/2011 - 14:38:32	Test 3	CT	Normal	24,998:1	N/A	0 mA	19920 A	7200 A
28/01/2011 - 14:39:14	Test 4	CT	Normal	90,900:1	N/A	0 mA	19920 A	7200 A
28/01/2011 - 14:39:44	Test 5	CT	Normal	908,99:1	N/A	0 mA	19920 A	7200 A
28/01/2011 - 14:40:56	Test 6	VT/PT	Normal	1,0007:1	N/A	125 mA	19920 V	7200 V
28/01/2011 - 14:41:38	Test 7	VT/PT	Normal	1,0007:1	N/A	0 mA	19920 V	7200 V
28/01/2011 - 14:42:06	Test 8	VT/PT	Normal	4,9988:1	N/A	0 mA	19920 V	7200 V
28/01/2011 - 14:42:30	Test 9	VT/PT	Normal	24,998:1	N/A	0 mA	19920 V	7200 V
28/01/2011 - 14:42:51	Test 10	VT/PT	Normal	90,908:1	N/A	0 mA	19920 V	7200 V
28/01/2011 - 14:43:13	Test 11	VT/PT	Normal	909,02:1	N/A	1 mA	19920 V	7200 V
28/01/2011 - 14:43:58	Test 12	VT/PT	Normal	2498,5:1	N/A	0 mA	19920 V	7200 V
28/01/2011 - 14:44:19	Test 13	VT/PT	Normal	5002,5:1	N/A	1 mA	19920 V	7200 V
28/01/2011 - 14:44:40	Test 14	VT/PT	Normal	8337,7:1	N/A	1 mA	19920 V	7200 V
28/01/2011 - 14:45:14	Test 15	VT/PT	Normal	-302,97:1	N/A	1 mA	19920 V	7200 V

DTR MODULE Recovery of the measurement data recorded in the ratiometer



ACCESSORIES FOR MULTI-FUNCTION INSTALLATION TESTERS

■ Accessories ■ Included in the original delivery

	ARTICLE CODE	DESCRIPTION	C.A 6113	C.A 6116N	C.A 6117
MEASUREMENT LEADS AND SENSORS	 P01295398	2.5 m three-point lead with separate wires	■	■	■
	 P01295393	Three-point lead for EURO mains socket test	■	■	■
	 P01295094	2 elbowed-straight safety leads - (red and black) 3 m long	■	■	■
	 P01101921	3 test probes Ø 4 mm - (red, blue and green)	■	■	■
	 P01101922	3 crocodile clips (red, blue and green)	■	■	■
	 P01102092A	Remote-control probe for C.A 6116N	■	■	■
	 P01101943	Replacement black test probe for remote-control probe	■	■	■
	 P01120335	C177 clamp (20 A)	■		
	 P01120336	C177A clamp (200A)	■	■	■
	 P01120460	MN77 clamp (20A)	■	■	■
POWER SUPPLY / BATTERIES	 P01102057	PA 30 W power pack	■		
	 P01102129	Type-2 power pack / charger without mains lead (requires P01295174)		■	■
	 P01296024	NiMH 35 Wh battery pack	■		
	 P01296047	Li-Ion battery pack		■	■
	 P01102130	Li-Ion charger support without mains lead		■	■
	 P01295174	2P EURO mains lead	■	■	■
	 HX0061	DC/DC charger for vehicle cigarette lighter	■		
MISCELLANEOUS	 P01102084A	Continuity rod	■	■	■
	 P01102017	15 m earth kit (red / blue / green)	■	■	■
	 P01102018	Black 30 m 1P earth kit	■	■	■
	 P01102021	3P earth kit (50 m)	■	■	■
	 P01102022	3P earth kit (100 m)	■	■	■
	 P01298081	4-point hands-free strap - model 2	■	■	■
	 P01298057	Hand strap	■	■	■
	 P01102094	C.A 61 screen protection film	■	■	■
	 P01298056	Shoulder bag no. 22	■	■	■
	 P01295293	USB-A USB-B cable	■	■	■
 P01102095	DataView® software		■	■	
 P01298082	Comfort strap	■	■	■	



MEASUREMENT LEADS FOR INSULATION TESTERS

■ Accessories ■ Included in the original delivery

	CODE ARTICLE	DESCRIPTION	LENGTH	C.A 6505	C.A 6545	C.A 6547	C.A 6549	C.A 6550	C.A 6555
5 KV RANGE	 P01295231	Red simplified HV safety lead / black with rear connection	3 m	■	■	■	■		
	 P01295232	Blue simplified HV safety lead + blue crocodile clip	3 m	■	■	■	■		
	 P01295221	Guarded blue simplified HV safety lead with rear connection	0.35 m	■	■	■	■		
	 P01295220	Set of 3 safety leads with HV crocodile clips - red, blue and black	3 m	■	■	■	■		
	 P01295214	Safety lead with blue HV crocodile clip	8 m	■	■	■	■		
	 P01295215	Safety lead with red HV crocodile clip	8 m	■	■	■	■		
	 P01295216	Safety lead with rear connection and black HV crocodile clip	8 m	■	■	■	■		
	 P01295217	Safety lead with blue HV crocodile clip	15 m	■	■	■	■		
	 P01295218	Safety lead with red HV crocodile clip	15 m	■	■	■	■		
10/15 KV RANGE	 P01295465	Set of 3 red, blue and black simplified HV safety leads with rear connection	3 m					■	■
	 P01295466	Set of 3 safety leads with red, blue and black HV crocodile clips with rear connection	3 m					■	■
	 P01295467	Guarded blue HV safety lead with rear connection	0.5 m					■	■
	 P01295468	Safety lead with blue HV crocodile clip	8 m					■	■
	 P01295469	Safety lead with red HV crocodile clip	8 m					■	■
	 P01295470	Safety lead with rear connection and black HV crocodile clip	8 m					■	■
	 P01295471	Safety lead with blue HV crocodile clip	15 m					■	■
	 P01295472	Safety lead with red HV crocodile clip	15 m					■	■
	 P01295473	Safety lead with rear connection and black HV crocodile clip	15 m					■	■
	 P01295471A	Safety lead with blue HV crocodile clip	20 m					■	■
	 P01295472A	Safety lead with red HV crocodile clip	20 m					■	■
	 P01295473A	Safety lead with rear connection and black HV crocodile clip	20 m					■	■



ELECTRICAL SAFETY

CONTENTS OF THE EARTH & RESISTIVITY KITS

To order		Contents of the earth and resistivity kits							Recommended associated products									
Article code	Description	Reels and winders				Other accessories			Installation testers		3P	3/4P+ρ	Expert		Pylon			
		Green	Red	Blue	Black	Stake(s) / Mallet	Spade-lug / banana adapter	Bag	C.A 6030	C.A 6113	C.A 6116N C.A 6117	C.A 6421 C.A 6423	C.A 6460 C.A 6462	C.A 6470N	C.A 6471	C.A 6472	C.A 6474	
1P KIT	P01102018	Black 30 m 1P earth kit				33 m	1 / -				■	■						
	P01102020	33 m 1P loop kit	33 m				1 / -		■									
3P KIT	P01102017	15 m 3P earth kit (red, green, blue)	5 m	15 m	10 m		2 / -				■	■						
	P01102021	50 m 3P earth kit	10 m	50 m	50 m		2 / 1	5	Standard		■	■	■	■				
	P01102022	100 m 3P earth kit	10 m	100 m	100 m		2 / 1	5	Standard			■	■	■	■	■		
	P01102023	166 m 3P earth kit	10 m	166 m	166 m		2 / 1	5	Prestige			■	■	■	■	■		
4P KIT	P01102040	50 m 4P resistivity kit	33 m	50 m	50 m	33 m	4 / 1	5	Standard				■	■	■	■		
	P01102024	100 m earth & resistivity kit	100 m 10 m	100 m	100 m	33 m	4 / 1	5	Prestige				■	■	■	■		
	P01102025	166 m earth & resistivity kit	100 m 10 m	166 m	166 m	33 m	4 / 1	5	Prestige				■	■	■	■		
Add-on	P01102030	100 m add-on for resistivity	100 m				2 / -	Standard					■	■	■	■		

OTHER ACCESSORIES

Article code	Description	Reels and winders			
		Green	Red	Blue	Black
P01102026	Green cable winder	10 m			
P01102028	Set of 5 adapters for terminals				
P01102029	Set of 4 reel handles				
P01102031	T earth stake				
P01102046	Set of 3 adjustable clamps				
P01102047	10 m black cable H winder				10 m
P01120310	C172 clamp				
P01295260	166 m reel of red cable		166 m		
P01295261	100 m reel of red cable		100 m		
P01295262	50 m reel of red cable		50 m		
P01295263	166 m reel of blue cable			166 m	
P01295264	100 m reel of blue cable			100 m	
P01295265	50 m reel of blue cable			50 m	
P01295266	100 m reel of green cable	100 m			
P01295267	33 m reel of black cable				33 m
P01295268	33 m reel of green cable	33 m			
P01295270	2 m black cable winder (2 m cable for clamps)				2 m
P01295291	5 m green cable winder	5 m			
P01295292	5 m black cable H winder				5 m

Article code	Description																	
P01102037	C.A 647x continuity kit (4 croc. clips - red, black, blue and yellow), (2 red/black test probes), (4 x 1.5m cables, red, black, blue and yellow)																	
P01120550	5m AmpFlex™ flexible current sensors																	■
P01120551	8m AmpFlex™ flexible current sensors																	■
P01102046	Set of 3 adjustable clamps																	■
P01120310	C172 clamp	■																
P01120335	C177 clamp								■									
P01120336	C177A clamp																	
P01120333	C182 clamp																	■

ADDITIONAL INFO

- Possibility of ordering the carrying bag:
- Standard version _____
- Prestige version _____





















P01298066
P01298067











ACCESSORIES FOR ELECTRICAL EQUIPMENT TESTERS

■ Optional accessories ■ Included in the original delivery

	ARTICLE CODE	DESCRIPTION	LENGTH	C.A 6121	C.A 6155	C.A 6160
Measurement and test leads						
	P01295097	4 mm banana cable - red + black	3 m	■		■
	P01295137	Double crocodile cable - black	2.5 m	■		
	P01295140	Double crocodile cable - red	2.5 m	■		
	P01295141	Discharge lead (EURO)	2 m	■		■
	P01295236	Double continuity cables	2.5 m			■
	P01295234	Power supply cable (EURO)	2 m			■
	P01102139	Test lead - red	4 m		■	
	P01102136	Plug-in test cable	1.5 m		■	
	P01102137	Test cable with separate wires	3 m		■	
	P01102138	Black + red test lead	1.5 m		■	
	P01102140	Green test lead	1.5 m		■	
	P01102141	Black test probe for C.A 6155			■	
	P01102142	Red test probe for C.A 6155			■	
	P01102143	Green test probe for C.A 6155			■	
	P01102144	Blue test probe for C.A 6155			■	
	P01102145	Set of 3 black crocodile clips			■	
HV test guns and probes						
	P01101919	HV test gun	2 m	■		■
	P01102135	HV test probe for C.A 6155			■	
	P01101918	HV test gun	6 m	■		■
Remote control, indication and communication						
	P01101916	Remote-control pedals		■		■
	P01101917	Red / green indicator lamps		■		■
	P01101841	DB9F-DB25M adapter		■		■
	P01295172	DB9F-25F cable x 2		■		■
	P01295173	DB9F-DB9M cable no. 1		■		
	P01101915	MachineLink software with communication cables		■		
		CALink software			■	
	P01101996	CELLink software with communication cables				■
Fuses						
	P01297086	F 6x32T 16 A 250 V (set of 10 fuses)			■	■



■ Optional accessories ■ Included in the original delivery

	ARTICLE CODE	DESCRIPTION	CONNECTIONS	C.A 6240	C.A 6250	C.A 6292	DTR 8510	C.A 6681	C.A 6630
Double test probes and Kelvin clamps for pour micro-ohmmeters									
	P01101794	10 A Kelvin clamps (set of 2), L=3 m	Spade lug	■	■				
	P01101783	1A mini Kelvin clamps (set of 2)	Spade lug	■	■				
	P01103065	10 A double gun-type test probe (set of 2) L= 3.15m	Spade lug and 4 mm banana	■	■				
	P01103063	10 A double pivoting test probe (set of 2) L= 3.15m	Spade lug and 4 mm banana	■	■				
	P01102056	1 A double test probe (set of 2) L=2.85m	Spade lug and 4 mm banana	■	■				
	P01295486	Set of 2 Kelvin leads 6 m long (red / black) with adjustable-clamp connections				■			
	P01295487	Set of 2 Kelvin leads 15 m long (red / black) with adjustable-clamp connections				■			
	P01295488	Green earth lead with crocodile clip				■			
	P01120470	MR6292 clamp				■			
Other accessory for micro-ohmmeters									
	P01102013	Pt 100 sensor			■				
Measurement lead for ratiometer									
	P01295143A	Set of 2 replacement leads, H primary, X secondary L= 4.6m , compatible with DTR 8500 / DTR 8510	4 mm banana				■		
Adapters for cable and metal conductor locator									
	P01102114Z	Kit of 3 measurement adapters for housing (B22, E27, mains socket)	B22 bayonet E27 screw socket 2P mains socket					■	
Measurement lead for battery capacity tester									
	P01102103	Set of 2 double-contact current / voltage measurement leads for C.A 6630 battery tester. L=1m	Jack						■



ACCESSORIES / REPLACEMENT PARTS

INSTALLATION TESTERS

C.A 6030

■ C172 current clamp	P01120310
■ C176 clamp	P01120330
■ MN20 current clamp	P01120440
■ Series printer no. 5	P01102903
■ 1P loop kit	P01102020
■ 3 crocodile clips (red/white/yellow)	P01101905
■ 3 test probes (red/white/yellow)	P01101906A
■ Optical / RS232 connection cable	P01295252
■ 10 m green cable H winder	P01102026
■ T earth stake	P01102031
■ 100 m reel of green cable	P01295266
■ 33 m reel of green cable	P01295268
■ Standard bag no. 5	P01298066

INSULATION TESTERS

C.A 6501 and C.A 6503

■ Bag no. 2	P01298006
■ C.A 846 thermo-hygrometer	P01156301Z
■ C.A 861 K thermocouple	P01650101Z
■ 0.2 A / HRC fuse for C.A 6501	P01297095
■ 2 crocodile clips (red/black)	P01295457Z
■ 2 test probes (red/black)	P01295458Z
■ 2 leads 1.5 m long (red/black)	P01295289Z
■ 3 crocodile clips (red, black, blue)	P01103062
■ 3 safety leads 1.5 m (red, black, blue)	P01295171

C.A 6511 and C.A 6513

■ C.A 861 thermometer + K thermocouple C.A 861	P01650101Z
■ C.A 846 thermo-hygrometer	P01156301Z
■ 2 crocodile clips (red/black)	P01295457Z
■ 2 test probes (red/black)	P01295454Z
■ 2 leads 1.5 m long (red/black)	P01295288Z
■ 1.5 V LR6 battery	P01296033
■ 1.6 A fuse	P01297022
■ Shockproof sheath no. 13	P01298016

C.A 6522, C.A 6524, C.A 6526, C.A 6532, C.A 6534 and C.A 6536

■ Remote-control probe	P01101935A
■ C.A 861 thermometer + K thermocouple C.A 861	P01650101Z
■ C.A 846 thermo-hygrometer	P01156301Z
■ Hands-free bag	P01298049
■ 1.5 V LR6 battery	P01296033
■ Test probes (red + black)	P01295454Z
■ Crocodile clips (red + black)	P01295457Z
■ Elbowed-straight safety leads (red + black) 1.5 m long	P01295453Z
■ DataView® software	P01102095

C.A 6541 and C.A 6543

■ Remote-control probe	P01101935
■ C.A 861 thermometer + K thermocouple C.A 861	P01650101Z
■ C.A 846 thermo-hygrometer	P01156301Z
■ AN1 artificial neutral box	P01197201
■ Bag no. 6 for accessories	P01298051
■ 1.5 V LR14 battery	P01296034
■ Fuse F 2.5 A - 1,200 V - 8 x 50 mm - 15 kA (x 5)	P01297071
■ Fuse F 0.1 A - 660 V - 6.3 x 32 mm - 20 kA (x 10)	P01297072

C.A 6543

■ Series printer no. 5	P01102903
■ Series-parallel adapter	P01101941
■ DataView® software	P01102095
■ 1.5 m safety leads (red, blue, black)	P01295171
■ RS232 PC DB 9F - DB 25F cable x 2	P01295172
■ RS 232 printer DB 9F - DB 9M cable no. 01	P01295173
■ European 2P mains lead	P01295174
■ UK mains lead	P01295253
■ Battery pack	P01296021

C.A 6505, C.A 6545, C.A 6547 and C.A 6549

■ C.A 846 thermo-hygrometer	P01156301Z
■ C.A 861 thermometer + K thermocouple C.A 861	P01650101Z
■ AN1 artificial neutral box	P01197201
■ Standard bag for accessories	P01298066
■ Fuse FF 0.1 A - 380 V - 5 x 20 mm - 10 kA (x 10)	P03297514
■ European 2P mains lead	P01295174

**C.A 6547 and C.A 6549**

■ Series printer no. 5	P01102903
■ Series-parallel adapter	P01101941
■ DataView® report generation software	P01102095
■ RS 232 PC DB 9F - DB 25F cable x 2	P01295172
■ RS 232 printer DB 9F - DB 9M cable no. 01	P01295173

C.A 6550 and C.A 6555

■ 2 red/black test probes	P01295454Z
■ 3 red/blue/black crocodile clips	P01103062
■ USB optical cable	HX0056-Z
■ Shoulder bag	P01298066
■ C.A 861 thermocouple thermometer	P01650101Z
■ C.A 846 thermo-hygrometer	P01156301Z
■ European 2P mains lead	P01295174

MULTIMETER CLAMPS FOR LEAKAGE CURRENT**F62 and F65**

■ Red / black crocodile clamps (set of 2)	P01295457Z
■ Elbowed test-probe leads, 1.5 m, (1 red/1 black)	P01295456Z
■ Soft case 200 x 100 x 40 mm with belt clip	P01298065Z
■ CMI214S current measurement lead	P03295509
■ I/R probe for C.A 1871 multimeter	P01651610Z
■ C.A 801 single-channel temperature adapter	P01652401Z
■ 2-channel temperature adapter with differential measurement for C.A 803 multimeter	P01652411Z
■ Shoulder bag no. 21 (250 x 165 x 60 mm) with strap	P06239502

EARTH AND RESISTIVITY TESTERS**C.A 6421 and C.A 6423**

■ Carrying bag	P01298005
■ Fuse HRC 0.1 A - 250 V (x 10)	P01297012
■ 1.5 V LR06 battery	P01296033
■ Shoulder bag no. 2	P01298006

C.A 6416 and C.A 6417

■ DataView® software	P01102095
■ Bluetooth® / USB modem	P01102112
■ Hard case	P01298080
■ CL1 calibration loop	P01122301

C.A 6460 and C.A 6462

■ European 2P mains lead	P01295174
■ Fuse HRC 0.1 A - 250 V (x 10)	P01297012
■ Battery pack	P01296021
■ 1.5 V LR06 battery	P01296033
■ Standard bag	P01298066

C.A 6470N, C.A 6471 and C.A 6472

■ DataView® report generation software	P01102095
■ Adapter for battery charging on vehicle cigarette lighter	P01102036
■ Optical / RS communication cable	P01295252
■ UK mains lead	P01295253
■ Set of 10 fuses: F 0.63 A - 250 V - 5 x 20 mm - 1.5 kA	AT0094
■ Adapter for battery charging on the mains supply	P01102035
■ Battery pack	P01296021
■ Optical / USB communication cable	HX0056-Z



ACCESSORIES / REPLACEMENT PARTS

EARTH AND RESISTIVITY TESTERS

C.A 6471 and C.A 6472

■ MN82 clamp (diam. 20 mm) delivered with 2 m cable for connection to ES terminal	P01120452
■ C182 clamp (diam. 52 mm) delivered with 2 m cable for connection to ES terminal	P01120333
■ Standard bag	P01298066

C.A 6474

■ Connection cable	P01295271
■ 15 m BNC/BNC cable	P01295272
■ 5 m AmpFlex® flexible current sensor	P01120550
■ 8 m AmpFlex® flexible current sensor	P01120551
■ Set of 12 identification rings for AmpFlex®	P01102045
■ Set of 3 adjustable clamps	P01102046
■ 5 m green cable (E terminal connection)	P01295291
■ 5 m black cable (E terminal connection)	P01295292
■ Spade lug/banana plug adapter	P01102028
■ Calibration loop	P01295294
■ Prestige bag	P01298067

ELECTRICAL EQUIPMENT TESTERS

C.A 6121

■ Machine Link Windows processing software (supplied with communication cable)	P01101915
■ Series printer no. 5	P01102903
■ DB9F-DB25M adapter	P01101841
■ Remote-control pedal	P01101916
■ Indicator lamps (green/red)	P01101917
■ Roll of paper for series printer (set of 5)	P01101842
■ 2 crocodile clips (red/black)	P01295457Z
■ 2 test probes (red/black)	P01295458Z
■ 2 dielectric test guns with 6 m cable	P01101918
■ 2 dielectric test guns with 2 m cable	P01101919
■ 2 safety leads 3 m long (red/black)	P01295097
■ Continuity test lead 2.5 m long (black)	P01295137
■ Continuity test lead 2.5 m long (red)	P01295140
■ Discharge-time cable (European)	P01295141

C.A 6160

■ CE- Link processing software	P01101996
■ DB9F-DB25M software	P01101841
■ Remote-control pedal	P01101916
■ Indicator lamps (green/red)	P01101917
■ 2 dielectric test guns with 6 m cable	P01101918
■ 2 dielectric test guns with 2 m cable	P01101919
■ 2 safety leads 3 m long (red/black)	P01295097
■ European power cable	P01295234
■ RS232 DB9F-DB9F communication cable	P01295172
■ Set of 10 fuses: 2.5 A-250 V 5 x 20 T	P01297085
■ Set of 10 fuses: 16 A-250 V 6 x 32 T	P01297086
■ Standard bag	P01298066
■ Discharge-time cable	P01295141
■ 2 crocodile clips (red/black)	P01295457Z
■ 2 test probes (red/black)	P01295458Z

C.A 6155

■ 4 m red test lead	P01102139
■ Red + black 1.5 m test lead	P01102138
■ Red 1.5 m test lead	P01102140
■ 1.5 m plug-in test cable	P01102136
■ 3 m test cable with separate wires	P01102137
■ Black test probe	P01101141
■ Red test probe	P01102142
■ Green test probe	P01102143
■ Blue test probe	P01102144
■ Set of 3 black crocodile clips	P01102145
■ HV test probe	P01102135
■ Set of 10 fuses: 16 A-250 V 6 x 32 T	P01297086



OTHER TESTERS

C.A 6240 and C.A 6250

■ 1 A double test probe (x 2)	P01102056
■ Mini Kelvin clamp (set of 2)	P01101783
■ UK mains lead	P01295253
■ C.A 846 thermo-hygrometer	P01156301Z
■ European 2P mains lead	P01295174
■ Standard bag	P01298066
■ 10 A-P clamp (set of 2)	P01101794
■ DataView®	P01102095
■ Straight probe with 10 A double pivoting retractable test probe (x 2)	P01103063
■ Gun with 10 A double retractable test probe (x 2)	P01103065

C.A 6240

■ Set of 10 fuses: 6.3 x 32 / 12.5 A / 500 V	P01297091
■ Optical / USB communication cable	HX0056-Z

C.A 6250

■ Pt 100 temperature sensor	P01102013
■ 2 m cable for remote Pt 100	P01102014
■ Series printer no. 5	P01102903
■ RS 232 PC DB 9F – DB 25F cable x 2	P01295172
■ Set of 10 fuses: 6.3 x 32 / 16 A / 250 V	P01297089
■ Set of 10 fuses: 5.0 x 20 / 2 A / 250 V	P01297090

C.A 6292

■ 1 set of 2 Kelvin leads 6 m long (red / black) with adjustable-clamp connections	P01295486
■ 1 set of 2 Kelvin leads 15 m long (red / black) with adjustable-clamp connections	P01295487
■ 1 green earth lead with crocodile clip	P01295488
■ 1 set of 5 fuses: T1 5 A 250 V 5x20 mm	P01297101
■ 1 USB-A USB-B cable 1.5 m long	P01295293
■ 1 MR6292 clamp	P01120470

DTR 8510

■ Set of 2 replacement leads 4.6 m long	P01295143A
■ Set of 2 replacement leads 10 m long	P01295145
■ USB cable	P01295293
■ Shoulder bag	P01298066

C.A 6681

■ 33 m reel of green wire, battery clip/4 mm male banana on winder with handle	P01295268
■ 15 m reel of green wire, battery clip/4 mm male banana on H winder with 1 stake	P01102019
■ 10 m reel of green wire, battery clip/4 mm male banana on H winder	P01102026
■ Kit of 3 measurement adapters for housing (B22, E27, mains socket)	P01102114Z

C.A 6630

■ Set of 2 leads with retractable test probes	P01102103
---	-----------

SEE ALL OUR ACCESSORIES ON PAGE 230



C.A. 8336

Line 50Hz
Ah03 34.1s 28A 40W
max 34.5s THD 36.5%
min 11.5

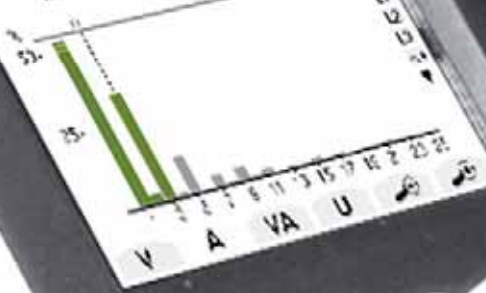

QUALITY

ENERGY QUALITY & INSTALLATION MONITORING

Info and advice	114
Power and harmonics clamps	118
Power and energy quality analysers	122
Electrical measurement loggers	126
Physical measurement loggers	136
Solar power analysers	139
Data processing software	142
Accessories	144



POWER AND DISTURBANCES

A phase of analysis is essential to precisely identify the behaviour of the installations and determine which solutions to implement.

The measurements made help to ensure that the solutions are pertinent and that the gains achieved are maintained over the long term in the context of an energy optimization programme.

POWER MEASUREMENTS

Power measurement is a key element for the definition, success and long-term effects of an energy optimization programme. Reducing electricity consumption is also a simple, painless way of saving money. Electricity is a clean energy source which is less harmful for the environment, but it does affect it nevertheless.

The various parameters of the installation are measured regularly, including the different power values used to size the electrical network and the phase shift data, as well as the voltage, current and frequency measurements.

For private customers, reactive power is neither measured nor billed separately. Instead it is included at a flat rate in the active power price. Things are very different for industrial customers, however. Electricity suppliers penalize consumers whose displacement power factor ($\cos \phi$ or DPF) is lower than 0.93 (in France) or whose $\tan \phi$ is higher than 0.4 (in France).

TROUBLESHOOTING DISTURBANCES

With the spread of systems incorporating electronics using switching power supplies, the electrical network is becoming increasingly polluted. A further complication is the fact that electricity market deregulation could lead to more frequent general network blackouts.

The quality requirements have become much more demanding and stringent than in the past. All the equipment in factories and buildings now includes digital electronics which are known to be sensitive to micro-outages, peaks and dips, harmonics and disturbances in general.

The complexity of industrial equipment makes it vulnerable to the voltage disturbances that occur on the electrical network. The arrival of new quick-switching components is leading to a large number of low-order harmonic currents (3, 5, 7, 9, 11, ...).

So **measurement provides the foundation for optimizing your installations' energy efficiency**, supervising your electrical networks and fairly allocating the costs.

	①	②	③	
P (W)	+34.83k	+34.77k	+34.60k	3L
Pdc (W)	+0	+0	+0	L1
Q ₁ (var)	€+19.71k	€+20.26k	€+20.01k	L2
D (var)	1.23k	1.12k	0.55k	L3
S (VA)	40.04k	40.26k	39.98k	Σ

This set of measurements will help the installation manager to size the capacitor banks correctly.





Some faults are encountered very frequently. In general, most disturbances are caused by:

Slow and transient voltage variations.

The voltage amplitude is a crucial parameter for electricity quality.

The voltage amplitude varies abnormally and may even drop to a level close to zero.

The causes mainly lie in the installation itself. The connection of heavy loads may lead to voltage variations if the short-circuit power at a point of supply is undersized.

Several types of faults are then defined: overvoltage, voltage dip, outage, etc. The rated network voltage variation range is set by the power distributor.

Flicker: rapid voltage fluctuations.

When **variable loads** such as arc furnaces, laser printers, microwave ovens or air-conditioning systems **are started up, they cause rapid voltage variations.** This phenomenon is called **flicker**. In reality, the flicker value is the result of a statistical calculation based on measurements of the rapid voltage variations.

A 10-minute interval is considered an acceptable compromise for evaluation of the short-term flicker (Pst).

If the combined effect of several disturbance-generating loads operating in a random way (e.g. welding units or motors) has to be taken into account or when flicker sources with long or variable operating cycles are involved (electric arc furnace), the resulting disturbance must be assessed over a longer time. The measurement duration defined is then 2 hours, a time considered appropriate for the load operating cycle or the time during which an observer may be sensitive to long-term flicker (Plt).

Harmonics and interharmonics.

The waveform of the current consumed by loads connected to the electrical network is often no longer purely sinusoidal. This current distortion implies distortion of the voltage which also depends on the impedance of the source. The **disturbances called harmonics are caused by connecting non-linear loads, such as equipment incorporating power electronics, to the network.** This may have instant consequences on certain electronic equipment: operating problems (synchronization, switching), untimely tripping, measurement errors on energy meters, etc. In the medium term, the extra heating caused by this may reduce the life span of rotating machines, capacitors, power transformers and neutral conductors.

Today's measuring instruments have to be capable of performing this harmonic analysis order by order, as well as measuring the Total Harmonic Distortion (THD) for more detailed diagnosis of the installation.

Electrical network analysers capable of recording disturbances for industrial companies and professionals in the electricity sector (producers, transmission companies, electricity users) **are essential tools for satisfactory supervision and timely maintenance of installations.**

They have to provide direct measurements, allow as much parameterization as possible for recording and facilitate subsequent analysis.



DATA LOGGING MADE SIMPLE

The **data logger family** is a cost-effective, advanced-design product line incorporating features and functions not found in data loggers costing 2 to 3 times their price. The choice of data storage modes and storage rates allows the operator to effortlessly configure these loggers to optimize memory usage for the application required.

Extended Recording Mode (XRM™) and delayed start time are **just two of the many application-friendly features** in these loggers.

An internal memory of 512 kB allows storage of over 240,000 measurements, more than enough for most data collection needs. **All the AC measurement loggers are True RMS (TRMS)** and all the DC measurement loggers allow the user to program both scale and engineering units. A full set of alarm programming tools allows programming of alarm set points and triggering on high, low, inside or outside trigger points.

Their battery operation and compact size allow **installation in locations where space is restricted** without the need for external power. A series of front-panel LEDs provides a quick overview of the logger's state and memory usage. Software is included as standard, providing real-time viewing of measurement data even while recording. Instrument configuration, data storage and report generation from predefined templates or operator custom-designed templates are also standard features. In addition, several data loggers can be synchronized to record at the same time intervals using DataView®.

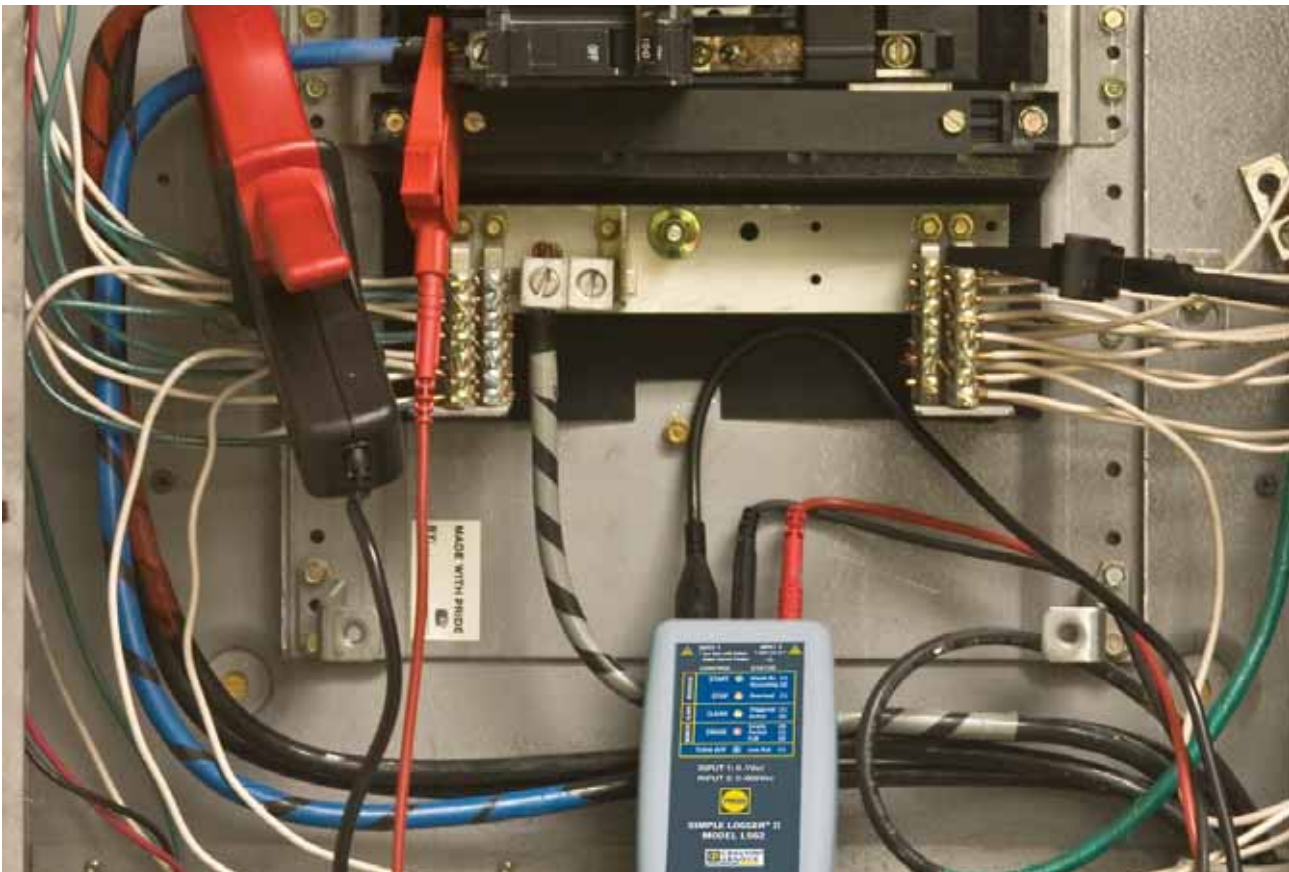



MAIN ADVANTAGES

- True RMS measurements provide an accurate representation of measured signals for AC models
- Choice of data storage modes to assist in matching the data collection to the needs of the application
- Stores over 240,000 measurements, ensuring that no valuable data is missed (more than 8 hours at 8 samples per second; approximately 1 week at one sample every 2 seconds)
- Compact size and battery operation
- Display and analyse real-time data through your PC

APPLICATIONS

- DataView® helps electricians or engineers to detect problems occurring randomly during fault/intermittent current detection
- Neutral current monitoring to detect unwanted leakage currents
- Real-time current harmonics monitoring to locate unwanted energy which causes equipment failure
- Load profiling which sizes loads for proper transformer and meter selection
- Split-phase load monitoring for residential voltage and current
- Machine load monitoring detects overload conditions causing premature equipment failure due to overheating
- Process loop monitoring can detect problematic sensors and control systems
- HVAC and general temperature profiling (refrigeration and air-conditioning systems)



CHOOSE YOUR POWER ANALYSER / POWER CLAMP



C.A 404
page 214



C.A 405
page 214



F205
page 43



F407
page 120



F607
page 121



C.A 8220
page 122



C.A 8230
page 123

Strengths	Specially for education	For small and medium power values	Power and harmonics in a clamp	Specially for motor maintenance	Specially for electrical network maintenance		
Number of U / I input channels	1	1	1	1	1		
Current							
(A)	1	5	600	1,000	2,000	Depending on sensors	Depending on sensors
Display							
Analogue	■	■					
Digital			■	■	■	■	■
Scope mode							■
Electrical network							
Single-phase	■	■	■	■	■	■	■
Balanced three-phase		■	■	■	■	■	■
Three-phase							
Measurements							
DC voltage			■	■	■	■	■
AC voltage			■	■	■	■	■
DC current			■	■	■	■	■
AC current			■	■	■	■	■
Frequency			■	■	■	■	■
Power							
VA			■	■	■	■	■
W	■	■	■	■	■	■	■
var			■	■	■	■	■
Cos φ / DPF				■	■	■	■
PF			■	■	■	■	■
Tan φ							■
Energy							
VAh, Wh, varh				■	■	■	■
Harmonics							
THD-r			■	■	■	■	■
THD-f				■	■	■	■
Decomposition				■	■	■	■
Others							
PST flicker							■
PLT flicker							
Sliding PLT flicker							
Unbalance							
Temperature						■	
Resistance			■	■	■	■	
Rotation speed						■	
Monitoring							
Recording				■	■		■
Transients							
Alarms							■
PC software				■	■	■	■

CHOOSE YOUR POWER ANALYSER / POWER CLAMP



C.A 8331
page 124



C.A 8333
page 124



C.A 8336
page 124



C.A 8435
page 124

Comfortable to handle and very compact	Ideal for installation maintenance	Top-of-the-range analysers	Special all-terrain and all-weather	Strengths
				Number of U / I input channels
3	3	4	4	
				Current
Depending on sensors	Depending on sensors	Depending on sensors	Depending on sensors	(A)
				Display
				Analogue
■	■	■	■	Digital
■	■	■	■	Scope mode
				Electrical network
■	■	■	■	Single-phase
■	■	■	■	Balanced three-phase
■	■	■	■	Three-phase
				Measurements
■	■	■	■	DC voltage
■	■	■	■	AC voltage
■	■	■	■	DC current
■	■	■	■	AC current
■	■	■	■	Frequency
				Power
■	■	■	■	VA
■	■	■	■	W
■	■	■	■	var
■	■	■	■	Cos φ / DPF
■	■	■	■	PF
■	■	■	■	Tan φ
				Energy
■	■	■	■	VAh, Wh, varh
				Harmonics
■	■	■	■	THD-r
■	■	■	■	THD-f
■	■	■	■	Decomposition
				Others
■	■	■	■	PST flicker
		■	■	PLT flicker
		■	■	Sliding PLT flicker
■	■	■	■	Unbalance
				Temperature
				Resistance
				Rotation speed
				Monitoring
■	■	■	■	Recording
	■	■	■	Transients
	■	■	■	Alarms
				PC software
■	■	■	■	



F407

Ref.: P01120947

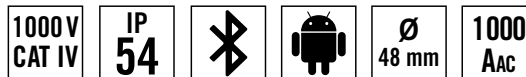

STRENGTHS

- Measurements up to 1,000 AAC or 1,500 ADC or AAC+DC
- Clamping \varnothing 48 mm
- Harmonic analysis up to the 25th order
- TrueInrush function
- 3-year warranty

SPECIFICATIONS

	F407
Current(RMS)	
AC	100 mA to 1,000 A
DC and AC+DC	100 mA to 1,500 A
Best accuracy	1% L + 3 counts
Voltage (RMS)	
AC	100 mV to 1,000 V
DC and AC+DC	100 mV to 1,000 V
Best accuracy	1% L + 3 counts
Auto AC/DC	Yes (V and A)
Resistance	100 k Ω
Continuity/buzzer	Yes (< 40 Ω)
Power W, var, VA	Yes, single and total three-phase
Crest factor (CF)	Yes
PF and cos φ (DPF)	Yes / Yes
Auto power-off	Yes
Hold function	Yes
Backlighting function	Yes
Min Max key	Yes
Peak +/- 100 ms function	Yes / Yes
TrueInrush function	Yes
THD-f / THD-r harmonics function	Yes / Yes
Decomposition into harmonic orders	25th order
REC storage function	Yes
Recordings (with Min, Max)	Up to 3,000 measurements
Bluetooth communication function	Yes
Frequency	15 Hz to 20 kHz
Clamping \varnothing	48 mm
Protection	IP 54
Electrical safety	IEC 61010 1000 V CAT IV
Warranty	3 years
Dimensions / weight	272 x 92 x 41 mm - 600 g (with batteries)

CONTENTS

- F407 delivered in a bag pre-equipped for MultiFix
- 1 set of banana/banana leads (red/black)
- 1 set of test probes (red/black)
- 1 set of crocodile clips (red/black)
- 4 x 1.5 V LR6 batteries
- 1 safety datasheet
- 1 CD-Rom containing a user manual and the PC data recovery software (Power Analyser Transfer)

ACCESSORIES / REPLACEMENT PARTS

- Set of banana/banana leads (red/black) P01295451Z
- Set of crocodile clips (red/black) P01295457Z
- See all the accessories on page 144



POWER AND HARMONICS MULTIMETER CLAMPS



F607

Ref.: P01120967

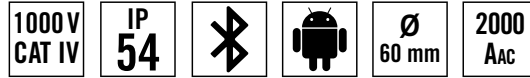

STRENGTHS

- Measurements up to 2,000 Aac or 3,000 Adc or Aac+dc
- Clamping \varnothing 60 mm
- Harmonic analysis up to the 25th order
- TrueInrush function
- 3-year warranty

SPECIFICATIONS

	F607
Current(RMS)	
AC	100 mA to 2,000 A
DC and AC+DC	100 mA to 3,000 A
Best accuracy	1% L + 3 counts
Voltage (RMS)	
AC	100 mV to 1,000 V
DC and AC+DC	100 mV to 1,000 V
Best accuracy	1% L + 3 counts
Auto AC/DC	Yes (V and A)
Resistance	100 k Ω
Continuity/buzzer	Yes (< 40 Ω)
Power W, var, VA	Yes, single and total three-phase
Crest factor (CF)	Yes
PF and cos φ (DPF)	Yes / Yes
Auto power-off	Yes
Hold function	Yes
Backlighting function	Yes
Min Max key	Yes
Peak +/- 100 ms function	Yes / Yes
TrueInrush function	Yes
THD-f / THD-r harmonics function	Yes / Yes
Decomposition into harmonic orders	25th order
REC storage function	Yes
Recordings (with Min, Max)	Up to 3,000 measurements
Bluetooth communication function	Yes
Frequency	15 Hz to 20 kHz
Clamping \varnothing	60 mm
Protection	IP 54
Electrical safety	IEC 61010 1000 V CAT IV
Warranty	3 years
Dimensions / weight	296 x 111 x 41 mm - 640 g (with batteries)

CONTENTS

- F607 delivered in a bag pre-equipped for MultiFix
- 1 set of banana/banana leads (red/black)
- 1 set of test probes (red/black)
- 1 set of crocodile clips (red/black)
- 4 x 1.5 V LR6 batteries
- 1 safety datasheet
- 1 CD-Rom containing 1 user manual and the PC data recovery software (Power Analyser Transfer)

ACCESSORIES / REPLACEMENT PARTS

- Set of banana/banana leads (red/black) P01295451Z
- Set of crocodile clips (red/black) P01295457Z
- See all the accessories on page 144



MOTOR MAINTENANCE



C.A 8220

Ref. : P01160620

600 V
CAT IIIIP
54

STRENGTHS

- Access to all the measurements simultaneously
- Low resistance and high current measurements
- Motor temperature measurement
- Motor rotation speed

SPECIFICATIONS

		C.A 8220
Voltage (TRMS)		Phase/Phase : 660 V _{AC+DC} Phase/Neutral : 600 V _{AC+DC}
Current (TRMS)		
	MN	MN93: 2 to 240 A _{AC} ; MN93A: 0.005 A _{AC} to 5 A _{AC} / 0.1 A _{AC} to 120 A _{AC}
	C	3 A to 1,200 A _{AC}
	AmpFlex® or MiniFlex®	30 A to 6,500 A _{AC}
	PAC	10 A to 1,000 A _{AC} / 10 A to 1,400 A _{DC}
	E3N	50 mA to 10 A _{AC+DC} , 100 mA to 100 A _{AC+DC}
Frequency		40 Hz to 70 Hz
Other measurements		W, var, PF, DPF, VA, temperature, phase rotation, RPM, resistance, continuity, diode test, Wh, VAh, varh
Harmonics		1st to 50th order
Sampling rate		256 samples/period
Recording capacity		≥ 9 complete sets of voltage, current, power and harmonics measurements
Power supply		6 x 1.5 V LR06 batteries, mains power supply available as an option
Battery life		≥ 8 hours with display activated
Communication		Optical USB
Display		Backlit 3-display screen with symbols
Dimensions / weight		211 x 108 x 60 mm / 0.88 kg
Electrical safety		IEC 61010 600 V CAT III, pollution degree 2

ADDITIONAL INFO

- The C.A 8220 analyser is also available with a current sensor:
- C.A 8220 MN93A P01160621
- C.A 8220 AmpFlex® P01160622

ACCESSORIES / REPLACEMENT PARTS

- C.A 1711 tachometer probe P01102082
- 2-wire Pt100 adapter HX0091
- See all the accessories on page 144

CONTENTS

- C.A 8220
- 2 banana leads
- 2 x 4 mm test probes
- 2 crocodile clips
- 6 x 1.5 V LR06 batteries
- 1 optical USB cable
- Power Analyser Transfer processing software
- 1 CD-ROM containing the user manual



ELECTRICAL NETWORK MAINTENANCE



C.A 8230

Ref. : P01160630

600 V CAT III	IP 54
------------------	----------

STRENGTHS

- Access to all the measurements simultaneously
- INRUSH function covering up to 18 s
- Colour graphical display
- Recording and alarms

SPECIFICATIONS

		C.A 8230
Voltage (TRMS)		Phase/Phase : 660 V Phase/Neutral : 600 V
Current (TRMS)		
	MN	MN93 : 2 to 240 Aac ; MN93A : 0.005 Aac to 5 Aac / 0.1 Aac to 120 Aac
	C	3 A to 1,200 Aac
	AmpFlex® or MiniFlex®	30 A to 6,500 Aac
	PAC	10 A to 1,000 Aac / 10 A to 1,400 Adc
	E3N	50 mA to 10 Aac+DC, 100 mA to 100 Aac+DC
Frequency		40 Hz to 70 Hz
Other measurements		VA, W, var, PF, DPF, Wh, varh, VAh, K factor, flicker, harmonic phase shift, phase rotation
Harmonics		THD, V, A, VA 1st to 50th order: direction, sequence
Sampling rate		256 samples/cycle
Recording capacity		1.5 MB partitioned for the waveforms, alarms and trend recordings
Power supply		6 rechargeable NiMH batteries (supplied) AC power supply: 120/230 Vac (50/60 Hz)
Battery life		≥ 8 h with display activated ≥ 40 with display deactivated (recording mode)
Communication		Optical USB
Display		¼ VGA colour LCD (320 x 240)
Dimensions / weight		211 x 108 x 60 mm / 0.88 kg
Electrical safety		IEC 61010 600 V CAT III, pollution degree 2

ADDITIONAL INFO

- The C.A 8230 analyser is also available with a current sensor:
 - C.A 8230 MN93A _____ P01160631
 - C.A 8230 AmpFlex® _____ P01160632

ACCESSORIES / REPLACEMENT PARTS

- Black MN93A clamp _____ P01120434B
- Black AmpFlex A193 450 mm _____ P01120426B
- See all the accessories on page 144

CONTENTS

- C.A 8230
- 2 banana leads
- 2 x 4 mm crocodile clips
- 2 crocodile clips
- 6 rechargeable NiMH batteries
- 1 x 230 V mains adapter
- 1 optical USB cable
- 1 bag no. 5
- Power Analyser Transfer processing software
- 1 CD-ROM containing the user manual

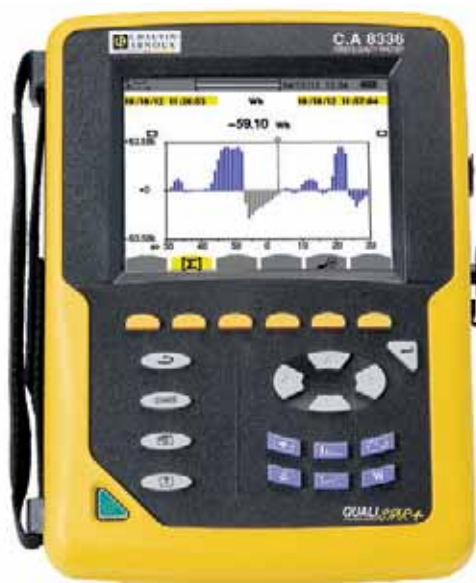
**C.A 8331 - C.A 8333 - C.A 8336**

Ref.: P01160511

P01160541

P01160591

C.A 8435

Ref.: P01160585

1000 V
CAT III**600 V**
CAT IV**3U**
4I**4U**
4I**IP**
53**IEC**
61000-4-30**EN**
50160**STRENGTHS**

- TRMS AC+DC voltage and current, frequency
- Measurements for power surveys
- Measurements for sizing the anti-harmonic filters
- Simultaneous recording of all the parameters
- Capture of all the transients, alarms and waveforms

CONTENTS

- **C.A 8331 / C.A 8333 / C.A 8336** delivered with:
 - 1 bag No. 22
 - 1 USB lead
 - 1 mains adapter
 - 4 x 4 mm banana voltage leads 3 m long (5 leads for C.A 8336)
 - 4 crocodile clips (5 clips for C.A 8336)
 - 1 safety datasheet
 - 1 set of 12-colour markers for identifying the leads and inputs
 - 1 anti-scratch screen protection film (mounted)
 - 1 CD-ROM containing the Power Analyser Transfer PC data recovery software
- **C.A 8435** delivered with:
 - 1 bag no. 22
 - 1 mains power cable
 - 1 USB cable
 - 1 IP65 mains power cable
 - 5 x 4 mm banana voltage leads 3 m long
 - 5 crocodile clips
 - 1 set of 12-colour markers for identifying the leads and inputs
 - 1 anti-scratch screen protection film (mounted)
 - 1 safety datasheet
 - 1 CD-ROM containing the Power Analyser Transfer PC data recovery software

Don't forget to order your current sensors - see page 210**ADDITIONAL INFO**

- The **C.A 8435** is also available in a complete version ____ Ref. P01160587
 - 4 AmpFlex® A196 450 IP65 current sensors,
 - 5 IP65 BB196 black banana leads 3 m long
 - 5 lockable crocodile clips
- The Power Analyser Transfer PC data recovery software is supplied as standard

ACCESSORIES / REPLACEMENT PARTS

- Black MN93A current sensor _____ P01120434B
- PA31ER mains adapter _____ P01102150
- See all the accessories on page 144



FUNCTIONS

- Real-time waveform display (5 voltage inputs and 4 current inputs)
- ½-period RMS voltage and current measurements
- Intuitive use
- Automatic recognition of the different types of current sensors
- Integration of all the DC components
- Voltage and current ratios
- Mixing of current sensors
- Measurement, calculation and display of the harmonics up to the 50th order, along with their phase information
- Calculation of the Total Harmonic Distortion (THD)
- Transient capture down to a single sample (1/256th of a period)
- Display of phasor diagram
- Measurement of power values: VA, W, VAD, total var and var per phase
- Measurement of energy values: VAh, Wh, VADh, total varh and varh per phase
- Calculation of K factor and FHL
- Calculation of $\cos \varphi$ displacement power factor and (DPF) and power factor (PF)
- Capture of up to 210 transients
- Calculation of PST & PLT Flicker
- Calculation of unbalance (current and voltage)
- Monitoring of the electrical network with setting of alarms
- Backup and recording of screenshots (image and data)
- Recording and export on PC
- Real-time data recovery and communication software on PC
- EN 50160 reports

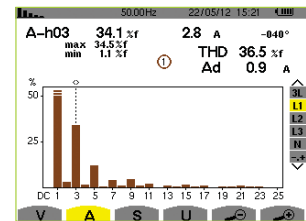
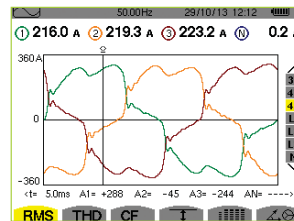

SPECIFICATIONS

	C.A 8331	C.A 8333	C.A 8336	C.A 8435
Number of channels	3U / 4I		4U / 4I	
Number of inputs	4V / 3I		5V / 4I	
IEC 61000-4-30	-	EN50160 reports		-
Voltage (TRMS AC+DC)	2 V to 1,000 V Up to 500 kV			
Current (TRMS AC+DC)	Voltage ratio			
	MN			
	MN93 : 500 mA to 200 Aac ; MN93A : 0.005 Aac to 100 Aac			
	C193			
	1 A to 1,000 Aac			
AmpFLEX™ or MiniFlex®	100 mA to 10,000 Aac		30 A to 6,500 Aac	
PAC93	1 A to 1,300 Aac/dc			
E3N	50 mA to 100 Aac/dc			
Current ratio	Up to 60 kA			
Frequency	40 Hz to 69 Hz			
Power values	W, VA, var, VAD, PF, DPF, $\cos \varphi$, tan φ			
Energy values	Wh, varh, VAh, VADh			
Harmonics	Yes			
THD	Yes, 0 to 50th order, phase			
Expert mode	-	Yes		Yes
Transients	-	50	210	
Flicker	-	Pst	Pst and Plt	
Inrush mode	-	Yes on 4 periods		Yes > 10 minutes
Unbalance	Yes			
Recording	Yes			
Min/Max parameters at the max. sampling rate	4 hours to 2 weeks	A few days to several weeks		2 weeks to several years
Alarms	-	4,000 of 10 different types		10,000 of 40 different types
Peak	Yes			
Vectorial representation	Automatic			
Display	¼ VGA colour TFT screen, 320 x 240, diagonal 148 mm			
Capture of screens and curves	12			50
Electrical safety	IEC 61010 1000 V CAT III / 600 V CAT IV			
Protection rating	IP53 / IK08		IP67	
Languages	More than 27			
Communication interface	USB			
Battery life	Up to 10 hours			
Power supply	Rechargeable 9.6 V NiMH battery or mains power supply			
Dimensions / weight	240 x 180 x 55 mm / 1.9 kg		270 x 250 x 180 mm / 3.7 kg	



CHOOSE YOUR ELECTRICAL MEASUREMENT LOGGER



PEL103
page 128

PEL102
page 128

PEL105
page 129

L562
page 130

CL601
page 131

L101
page 132

With display



Without display



Power

Power values



Energy values



Current

Clamp format



Voltage inputs
(format)

Qualistar

Qualistar

Qualistar

BNC

BNC

Current inputs
(format)

Number of inputs

3

3

4

1

1

1

Sensor type

See acc.

See acc.

See acc.

See acc.

See acc.

Voltage

RMS



DC



Number of inputs

3

3

4

1



CHOOSE YOUR ELECTRICAL MEASUREMENT LOGGER

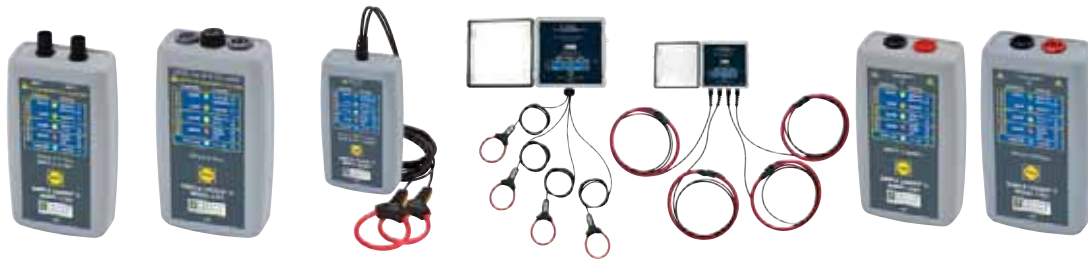

L102
page 132

L111
page 132

ML912
page 133

ML914
page 134

AL834
page 134

L261
page 135

L481
page 135

	L102	L111	ML912	ML914	AL834	L261	L481	
								With display
	■	■	■	■	■	■	■	Without display
								Power
								Power values
								Energy values
								Current
								Clamp format
	BNC							Voltage inputs (format)
		Banane						Current inputs (format)
	2	1	2	4	4			Number of inputs
	See acc.	See acc.	MiniFlex®	MiniFlex®	AmpFlex®			Sensor type
								Voltage
						■		RMS
						■	■	DC
						1	1	Number of inputs



PEL 102 - PEL 103

Ref.: P01157152

P01157153

1000 V
CAT III600 V
CAT IVIP
54

STRENGTHS

- Compatible with all electrical networks: single-phase, split-phase, three-phase with or without neutral, etc.
- Implementation without powering down the electrical network
- All the instruments can be powered by the phase
- Data recording on integrated SD card
- Compact and magnetized for mounting in closed cabinets

ADDITIONAL INFO

- The PEL Transfer analysis software is delivered as standard for:
 - Configuration of the PEL100s
 - Verification of the connections before recording starts
 - Downloading of the recorded measurements
 - Display of the various measurement results and analyses

ACCESSORIES / REPLACEMENT PARTS

- Bag no. 23 P01298078
- Mains adapter P01102134
- See all the accessories on page 144

CONTENTS

- A PEL 102 or PEL 103 logger delivered with:
 - 4 measurement leads
 - 4 crocodile clips (black)
 - 1 x 2 GB SD card
 - 1 set of markers (for the ends of the leads and current sensors)
 - 1 mains power cable
 - 1 USB cable (Type A / Type B)
 - 1 Multifix mounting system
 - 1 carrying bag
 - 1 safety datasheet
 - PEL Transfer PC software
 - 1 SD USB adapter
 - 1 CD-ROM containing the user manual

SPECIFICATIONS

	PEL 102	PEL 103
Display	None	With triple digital display
Type of installation	Single-phase, split-phase, three-phase with or without neutral, etc.	
Number of channels	3U / 4I	
Number of inputs	4U / 3I	
Measurements		
Network frequency	DC, 50 Hz, 60 Hz & 400 Hz	
Voltage (measurement range)	10.00 to 1,000 V _{AC/DC}	
Current	MN93	500 mA to 200 A _{AC}
	MN93A	5 mA to 100 A _{AC}
	C193	1 A to 1,000 A _{AC}
	AmpFlex® A193 & MiniFlex® MA193	200.0 mA to 10.00 kA _{AC}
	PAC93	1 A to 1,000 A _{AC} 1 A to 1,300 A _{DC}
	E3N	50 mA to 10 A _{AC/DC} 100 mA to 100 A _{AC/DC}
	J93	50 A to 3,500 A _{AC} / 50 A to 5,000 A _{DC}
Calculated Measurements		
Ratios	Up to 650,000 V / up to 25,000 A	
Power	10 W to 10 GW / 10 var to 10 Gvar / 10 VA to 10 GVA	
Energy	Up to 4 EWh / 4 EVAh / 4 Evarh (E = 10 ¹⁸)	
Phase	cos φ, tan φ, PF	
Harmonics	THD	
Additional functions		
Phase sequence	Yes	
Min / Max	Yes	
Mounting	Magnet, hook	
Recording		
Sampling rate / Acquisition interval / Aggregation	128 samples/period - 1 measurement/s from 1 min to 60 min	
Data storage	SD card, 8 GB (SD-HC card up to 32 GB)	
Communication	USB, Ethernet & Bluetooth®	
Power supply	110 V - 250 V (+10%, -15%) @ 50-60 Hz & 400 Hz	
Safety	IEC 61010 600 V CAT IV 1000 V CAT III	
Mechanical specifications		
Dimensions	256 x 125 x 37 mm without sensor	
Weight	900 g	950 g
Casing	IP54, ETL	



PEL 105

Ref.: P01157155

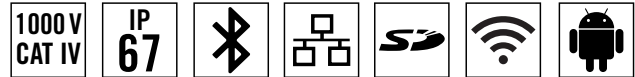

STRENGTHS

- Suitable for installation on an electricity pole
- All-terrain casing resistant to shocks, UV light and high temperatures
- Self-powered by its voltage inputs up to 1,000 V
- Continuous recording with a 200 ms acquisition interval
- Measurements in compliance with the IEEE 1459 standards

ADDITIONAL INFO

- When used with the DataView® software, the measurements made with the PEL105 can be processed directly for measurement report generation.
- Possibility of remote connection via an IRD server

ACCESSORIES / REPLACEMENT PARTS

- A196A current sensor P01120554
- Pole mounting kit P01102146
- See all the accessories on page 144

CONTENTS

- One PEL105 logger delivered with:
 - 5 black silicone leads 3 m long, straight banana / straight banana
 - 5 black crocodile clips, 1000 V CAT IV
 - 1 set of inserts/rings
 - 4 AmpFlex® IP67 A196 3 m long
 - 1 set of waterproof caps
 - 1 SD card
 - 1 USB cable
 - 1 bag
 - 1 safety datasheet
 - 1 USB key containing a quick startup guide and a user manual

SPECIFICATIONS

		PEL 105
Display	With triple digital display	
Type of installation	Single-phase, split-phase, three-phase with or without neutral, etc.	
Number of channels	4U / 4I	
Number of inputs	5U / 4I	
Measurements		
Network frequencies	DC, 50 Hz, 60 Hz & 400 Hz	
Voltage (measurement range)	10.00 V to 1,000 V _{AC/DC} @ 50/60 Hz 600 V _{AC} @ 400 Hz	
Current	MN93	500 mA to 200 A _{AC}
	MN93A	5 mA to 100 A _{AC}
	C193	1 A to 1,000 A _{AC}
	AmpFlex® A193 & MiniFlex® MA193	200 mA to 10 kA _{AC}
	PAC93	1 A to 1,000 A _{AC} / 1 A to 1,300 A _{DC}
	E3N	50 mA to 10 A _{AC/DC} / 100 mA to 100 A _{AC/DC}
J93	50 to 3,500 A _{AC} / 50 to 5,000 A _{DC}	
Calculated measurements		
Power	20 W to 10 GW 20 var to 10 Gvar 20 VA to 10 GVA	
Energy	Up to 4 EWh / 4 EVAh / 4 Evarh (E = 10 ¹⁸)	
Phase	cos φ, tan φ, PF	
Harmonics	THD	
Additional functions		
Phase sequence	Yes	
Min / Max	Yes	
Recording		
Sampling rate / Acquisition interval / Aggregation	128 samples./period 5 measurements/s From 1 min to 60 min	
Data storage	8 GB SD card (SD-HC card up to 32 GB)	
Communication	Ethernet, Bluetooth®, WiFi and USB	
Power supply	Self-powered internally from 94 to 1,000 V @ 50-60 Hz & 400 Hz / DC	
Safety	IEC 61010 - 1000 V CAT IV	
Mechanical specifications		
Dimensions	245 x 270 x 180 mm	
Weight	< 4 kg	
Casing	IP67	



TRMS VOLTAGE/CURRENT LOGGER



L562

Ref. : P01157060

600 V
CAT III300 V
CAT IV

TRMS



STRENGTHS

- Detects voltage drops and surges
- Monitors power consumption on single-phase networks, as well as energy consumption
- Up to 240,000 measurements saved in non-volatile memory
- Recording rate from 8/s to 1/day

SPECIFICATIONS

	L562	
Number of channels	2	
Connection	Current channel	Voltage channel
Input connection	BNC	Banana connector
Input range	0 to 1 Vac	0 to 600 Vac
Resolution	0,1 mV	0,1 V
Accuracy (50/60 Hz)	0 to 10 mV: not specified 10 to 50 mV: $\pm (0.5 \% R + 1 \text{ mV})$ 50 to 1,000 mV: $\pm (0.5 \% R + 0.5 \text{ mV})$	0 to 5 V: not specified 5 to 50 V: $\pm (0.5 \% R + 1 \text{ V})$ 50 to 600 V: $\pm (0.5 \% R + 0.5 \text{ V})$
Sampling rate	64 samples per period	
Storage interval	Programmable from 125 ms to 1 day	
Recording modes	Stop when full, FIFO, XRM™ extended recording mode and recording on alarms	
Recording duration	15 minutes to 8 weeks, programmable using DataView®	
Data storage	240,000 measurements (512 kB). The recorded data are stored in non-volatile memory, even if the battery is low or absent	
Communication	Optically-isolated USB 2.0	
Power supply	2 x 1.5 V LR06 batteries	
Battery life	100 hours to > 45 days (depending on recording interval/duration)	
Mechanical specifications		
Dimensions	136 x 70 x 32 mm	
Max. conductor sizes	Depends on current sensor	
Weight (with battery)	181 g	
Casing	UL94-V0	
Vibration	IEC 60068-2-6 (1,5 mm, 10 à 55 Hz)	
Shocks	IEC 60068-2-27 (30 G)	
Falls	IEC 60068-2-32 (1 m)	
Environment		
Operating temperature	-10 to +50 °C	
Storage temperature	-20 to +60 °C	

ADDITIONAL INFO

- Automatic report generation with the DataView® software

CONTENTS

- L562 delivered with:
 - 1 USB cable 2 m long, type A to mini-B 5-pin
 - PC communication software
 - 2 banana leads 1.5 m long
 - 2 crocodile clips
 - 2 x 1.5 V LR06 alkaline batteries

ACCESSORIES / REPLACEMENT PARTS

- Standard PVC leads with straight 4 mm male plugs P01295288Z
- 32 A crocodile clips P01102052Z
- See all the accessories on page 144



CL601

Ref.: P01157010



STRENGTHS

- Stand-alone with safe connections
- Alarm function
- Overload indication
- Monitoring of machine loads, electrical troubleshooting, etc.

SPECIFICATIONS

	CL601
Number of channels	1
Input connection	Split-phase current transformer AC current
Current range	0 to 600 A _{AC}
Resolution	0,1 A
Accuracy (50/60 Hz)	0 to 5 A: not specified 5 to 50 A: $\pm(1\% R + 1 A)$ 50 to 400 A: $\pm(1\% R + 0.5 A)$ 400 to 600 A: $\pm(3\% R + 1 A)$
Sampling rate	64 samples per period
Storage interval	Programmable from 125 ms to 1 day
Storage modes	Start/end, FIFO and XRM™ extended recording mode
Recording duration	15 minutes to 8 weeks, programmable using DataView®
Data storage	240,000 measurements (512 kB). The recorded data are stored in non-volatile memory, even if the battery is low or absent
Communication	Optically-isolated USB 2.0
Power supply	2 x 1.5 V LR06 batteries
Battery life	100 hours to > 45 days (depending on recording interval/duration)
Mechanical specifications	
Dimensions	235 x 102 x 41 mm
Max. conductor size	1 conductor \varnothing 42 mm, 2 conductors each with \varnothing 25.4 mm
Weight (with batteries)	485 g
Electrical safety	IEC 61010, 300 V CAT IV / 600 V CAT III
Casing	UL94-V0
Vibration	IEC 60068-2-6 (1.5 mm, 10 to 55 Hz)
Shocks	IEC 60068-2-27 (30 G)
Falls	IEC 60068-2-32 (1 m)
Environment	
Operating temperature	-10 to +50 °C
Storage temperature	-20 to +60 °C

ADDITIONAL INFO

- Automatic report generation

CONTENTS

- CL601 delivered with:
 - 1 USB cable 2 m long, type A to mini-B
 - 5 pins
 - PC communication software
 - 2 x 1.5 V LR06 batteries



TRMS CURRENT LOGGERS



L101 - L102 - L111

Ref. : P01157020 P01157030 P01157080

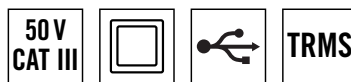

STRENGTHS

- **L101** records on request and can be used to monitor current on 1 channel
- **L102** can be used to monitor the neutral current in relation to the earth, as well as split-phase loads. It is equipped with 2 independent channels
- **L111** has the same function as the L101 but with single-channel connection via banana socket for clamps with current output

SPECIFICATIONS

	L101	L102	L111
Number of channels	1	2	1
Input connection	BNC	One BNC connector per channel	2 flush-mounted banana sockets
Current range	0 to 1 V _{ac} depending on sensor		
Resolution	0,1 mV		0,1 mA
Accuracy (50/60 Hz)	0 to 10 mV: not specified 10 to 50 mV: ± (0.5 % R + 1 mV) 50 to 1,000 mV: ± (0.5 % R + 0.5 mV)		0 to 10 mA: not specified 10 to 50 mA: ± (0.5 % R + 1 mA) 50 to 1,000 mA: ± (0.5 % R + 0.5 mA)
Sampling rate	64 samples per period		
Storage interval	Programmable from 125 ms to 1 day		
Storage modes	Start/end, FIFO, XRM™ extended recording mode and recording on alarms		
Recording duration	15 minutes to 8 weeks, programmable using DataView®		
Data storage	240,000 measurements (512 kB). The recorded data are stored in non-volatile memory, even if the battery is low or absent		
Communication	Optically-isolated USB 2.0		
Power supply	2 x 1.5 V LR06 batteries		
Battery life	100 hours to > 45 days (depending on recording interval/duration)		
Mechanical specifications			
Dimensions	136 x 70 x 32 mm	132 x 70 x 32 mm	
Max. conductor size	Depends on current sensor		
Weight (with batteries)	180 g		
Electrical safety	IEC 61010, 50 V CAT III		
Casing	UL94-V0		
Vibration	IEC 60068-2-6 (1,5 mm, 10 to 55 Hz)		
Shocks	IEC 60068-2-27 (30 G)		
Falls	IEC 60068-2-32 (1 m)		
Environment			
Operating temperature	-10 to +50 °C		
Storage temperature	-20 to +60 °C		

ADDITIONAL INFO

- Automatic report generation

CONTENTS

- **L101** and **L102** delivered with:
 - 1 USB cable 2 m long, type A to mini-B 5-pin
 - PC communication software
 - 2 x 1.5 V LR6 batteries
- **L111** delivered with:
 - 1 USB cable 2 m long, type A to mini-B 5-pin
 - PC communication software
 - 2 x 1.5 V LR06 batteries

ACCESSORIES / REPLACEMENT PARTS

- Bag with carrying strap _____ P01298076
- USB cable 2 m long, type A to mini-B 5-pin _____ Contact us
- See all the accessories on page 144



ML912

Ref.: P01157130

600 V
CAT III300 V
CAT IV

STRENGTHS

- Two MiniFlex® flexible current sensors for measuring currents from 0.5 A to 1,000 A
- Two ranges: 100 / 1,000 Aac
- Monitoring of loads on the phase
- Intermittent fault detection
- Monitoring of current harmonics

SPECIFICATIONS

	ML912	
Number of channels	2	
Input connection	Built-in MiniFlex® flexible AC current sensors	
Range	0.5 to 100 Aac	5 to 1,000 Aac
Resolution	0.1 mA	0.1 V
Accuracy	0 to 1 A: not specified 1 to 100 A: ±(1 % R + 0.5 A)	0 to 5 A: not specified 5 to 1,000 A: ±(1 % R + 1 A)
Sampling rate	64 samples per period	
Storage interval	Programmable from 125 ms to 1 day	
Storage modes	Start/stop, FIFO, XRM™ extended recording mode and recording on alarms	
Recording duration	15 minutes to 8 weeks, programmable using DataView®	
Data storage	240,000 measurements (512 kB). The recorded data are stored in non-volatile memory, even if the battery is low or absent	
Communication	Optically-isolated USB 2.0	
Power supply	2 x 1.5 V LR06 batteries	
Battery life	100 hours to > 45 days (depending on recording interval/duration)	
Mechanical specifications		
Dimensions	136 x 70 x 32 mm without sensor	
Weight (with batteries)	245 g	
Electrical safety	IEC 61010-1, 600 V CAT III, 300 V CAT IV, Pollution degree 2	
Casing	UL94-V0	
Vibration	IEC 60068-2-6	
Shocks	IEC 60068-2-27 (30 G)	
Falls	IEC 60068-2-32 (1 m)	
Environment		
Operating temperature	-10 to +50 °C	
Storage temperature	-20 to +60 °C	
Safety - electromagnetic compatibility		
Safety	IEC 61010-1 ; 600 V CAT IV ; Pollution degree 2	
Protection	IP40	

ADDITIONAL INFO

- Automatic report generation

CONTENTS

- ML912 delivered with:
 - 1 USB cable 2 m long, type A to mini-B 5-pin
 - PC communication software
 - 2 x 1.5 V LR06 batteries

ACCESSORIES / REPLACEMENT PARTS

- Bag with carrying strap P01298076
- USB cable 2 m long, type A to mini-B 5-pin Contact us
- See all the accessories on page 144



CURRENT LOGGERS WITH FLEXIBLE SENSORS

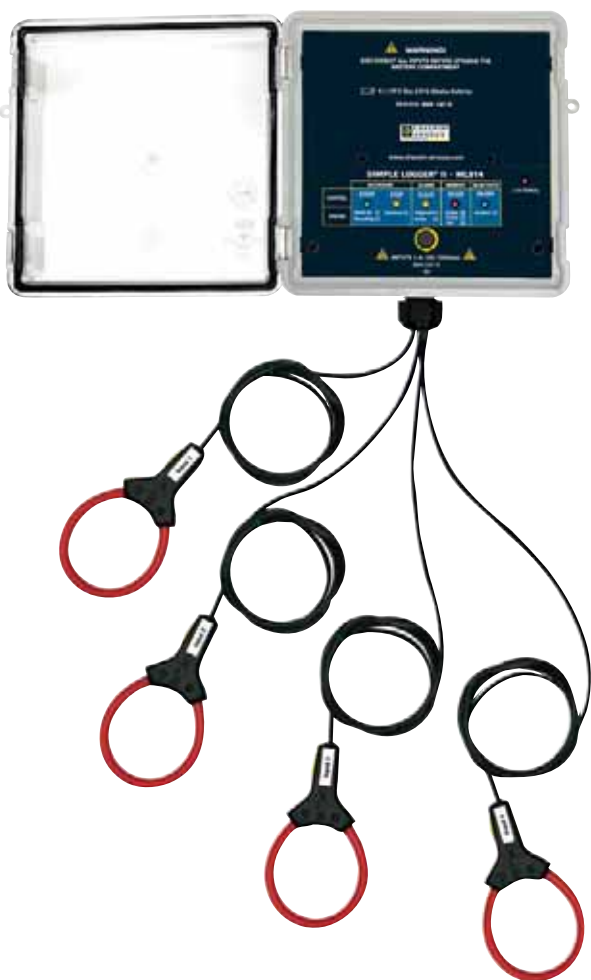

ML914 - AL834

Ref. : P01157135 P01157140

600 V CAT IV	1000 V CAT III	IP 65		TRMS
-----------------	-------------------	----------	--	------

STRENGTHS

- Compact current loggers with flexible sensors
- TRMS measurements up to 1,000 A_{AC} (ML914) or 3,000 A_{AC} (AL 834)
- Safe, accessible, risk-free measurements via the Bluetooth communication function
- DataView® software for effective analysis of your measurements

CONTENTS

- ML 914 delivered with:
 - PC communication software
 - 4 type-C batteries
 - 1 CD-ROM containing the user manual
 - 1 safety datasheet
- AL 834 delivered with:
 - PC communication software
 - 4 x 1.5 V LR14 batteries
 - 1 CD-ROM containing the user manual
 - 1 safety datasheet

ACCESSORIES / REPLACEMENT PARTS

- DataView® software P01102095
- Bag no. 23 P01298078
- See all the accessories on page 144

SPECIFICATIONS

	ML914		AL 834	
Number of channels	4			
Type of sensor	Built-in MiniFlex®		Built-in flexible sensors	
Range	100 A	1,000 A	300 A	3,000 A
Accuracy (50/60 Hz)	0 to 1 A: not specified 1 to 100 A: ± (1% R + 0.5 A)	0 to 5 A: not specified 5 to 1,000 A: ± (1% R + 1 A)	0 to 5 A: not specified 1 to 300 A: ± (1% R + 0.5 A)	0 to 15 A: not specified 15 to 3,000 A: ± (1% R + 1 A)
Resolution	0.1 V			
Sampling rate	64 samples per period			
Acquisition interval	Programmable from 125 ms to 1 day			
Storage modes	Start/stop, FIFO, XRM™ extended mode and on alarm			
Recording duration	15 minutes to 8 weeks, programmable using DataView®			
Data storage	1,000,000 measurements (2 MB)			
Communication	Bluetooth® (Class 2)			
Power supply	4 x 1.5 V LR14 batteries			
Battery life	Up to 180 days			
Safety	IEC 61010 600 V CAT IV and 1000 V CAT III			
Mechanical specifications				
Dimensions	150 x 150 x 90 mm without sensor		150 x 150 x 91 mm without sensor	
Max. conductor size	45 mm		203 mm	
Weight	1.1 kg		1.77 kg	
Casing	IP50 as per IEC 60529		IP65 as per IEC 60529	



L261 - L481

Ref.: P01157040 P01157110

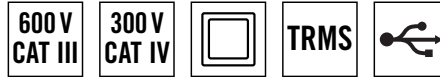

STRENGTHS

- **L261**
 - 600 Vac/dc TRMS
 - Suitable for industrial, commercial or residential monitoring
 - Recording of voltage drops and surges
- **L481**
 - 850 Vdc
 - Voltage monitoring on machines, wind turbines, railway applications, etc.
 - Detection of intermittent voltage faults

SPECIFICATIONS

	L261	L481
Number of channels	1	
Input connection	2 flush-mounted banana sockets	
Current range	0 to 600 Vac/dc	-850 Vdc to +850 Vdc
Accuracy (50/60 Hz)	0 to 5 V: not specified 5 to 50 V: ± (0.5 % R + 1 V) 50 to 600 V: ± (0.5 % R + 0.5 V)	0 to 5 V: not specified 5 to 50 V: ± (0.5 % R + 1 V) 50 to 850 V: ± (0.5 % R + 0.5 V)
Resolution	0.1 V	
Sampling rate	64 samples per period	8 samples per second
Storage interval	Programmable from 125 ms to 1 day	
Storage modes	Start/stop, FIFO, XRM™ extended measurement mode and recording on alarms	
Recording duration	15 minutes to 8 weeks, programmable using DataView®	
Data storage	240,000 measurements (512 kB). The recorded data are stored in non-volatile memory, even if the battery is low or absent	
Communication	Optically-isolated USB 2.0	
Power supply	2 x 1.5 V LR06 batteries	
Battery life	100 hours to > 45 days (depending on recording interval/duration)	
Mechanical specifications		
Dimensions	125 x 70 x 32 mm	
Weight (with batteries)	180 g	
Electrical safety	IEC 61010-1, 600 V CAT III, 300 V CAT IV, Pollution degree 2	
Casing	UL94-V0	
Vibration	IEC 60068-2-6 (1.5 mm, 10 to 55 Hz)	
Shocks	IEC 60068-2-27 (30 G)	
Falls	IEC 60068-2-32 (1 m)	
Environment		
Operating temperature	-10 to +50 °C	
Storage temperature	-20 to +60 °C	

ADDITIONAL INFO

- Automatic report generation

CONTENTS

- L261 and L481 delivered with:
 - 1 USB cable 2 m long, type A to mini-B 5-pin
 - PC communication software
 - 2 banana leads
 - 2 voltage leads 1.5 m long
 - 2 crocodile clips
 - 2 x 1.5 V LR06 batteries

ACCESSORIES / REPLACEMENT PARTS

- Standard PVC leads with 4 mm straight male plugs P01295288Z
- 32 A crocodile clips P01102052Z
- See all the accessories on page 144



CHOOSE YOUR PHYSICAL MEASUREMENT LOGGER



L452
page 137



L642
page 138

Number of inputs	2	2
Process		
4-20 mA	<input checked="" type="checkbox"/>	<input checked="" type="checkbox"/>
0-10 V	<input checked="" type="checkbox"/>	<input type="checkbox"/>
Temperature	<input type="checkbox"/>	<input checked="" type="checkbox"/>
Programmable storage interval	5 s to 1 day	125 ms to 1 day



ADDITIONAL INFO

- To simplify its use, the L452 is equipped with a magnetized rear panel. You can also use the Multifix system or a wall mount.

CONTENTS

- 1 L452 logger
- 1 adapter and 1 μ USB power cable
- 1 CD-ROM containing the Datalogger Transfer software

L452

Ref.: P01157201



STRENGTHS

- Process data logger with display
- 2 measurement channels
- Events counter
- Dry contact closure
- Detection of logic levels

SPECIFICATIONS

	L452			
	Measurement range	Resolution	Accuracy (% reading)	Sampling
Current DC	4 to 20 mA	0.01 mA	0.05 mA (0.25 %)	5 samples/s
Voltage DC	± 100 mV	± 0.1 mV	± 0.1 mV (0,5 %)	5 samples/s
	± 1 V	± 1 mV	± 1 mV (0,5 %)	
Impulsion	-	1 ms	-	-
Digital	-	1 ms	1 s (for recording for 1 month max.)	-
Pulse voltage	3.3 V (with 1,000,000 Ω pull-up)			
Battery life	Acquisition 200 ms, display on: 18 days Acquisition 200 ms, display off: 36 days Acquisition 1 min, display off: 270 days			
Power supply	110 to 240 V (50/60 Hz) – External: via USB connector Internal: 2.4 V rechargeable NiMH batteries (2 x 1.2 V)			
Storage modes	Start/Stop (stop when memory full or when campaign end date is reached)			
Control	Local mode (multi-directional keypad on front panel) Remote mode (control via PC)			
Recording duration	10 minutes to 1 year, configurable			
Examples	2 channels @ 200 ms: 19 days 2 channels @ 1 min: > 1 year (theoretically)			
Acquisition interval	200 ms to 1 hour			
Communication	Bluetooth 2.1, Class 1, USB 2.0			
Dimensions	32.4 x 65.5 x 125 mm (137.5 mm with screw connector)			
Weight	206 g			
Display	LCD 128 x 64 pixels			
Measurement terminal strip	6 screw terminals			
Operating temperature	0 to 50 °C			
Protection	IP42 (terminal block IP20)			
Electrical protection	IEC 61010-1 Ed. 3 and IEC 61010-2-030 Ed. 1			

ACCESSORIES / REPLACEMENT PARTS

- μ USB power-supply cable P01102148
- Screw-connector kit (x5) P01295489
- See all the accessories on page 144



TEMPERATURE LOGGER



L642

Ref. : P01157050

50 V
CAT III

STRENGTHS

- Monitoring of processes, heating systems and air-conditioning
- 2 input channels for thermocouple (J, K, T, N, E, R, S)
- Storage interval programmable from 1 every 5 seconds up to 1 per day
- Choice of 4 recording modes
- Up to 240,000 measurements saved in non-volatile memory

SPECIFICATIONS

	L642
Number of channels	2
Input connection	2 miniature thermocouple connectors
Measurement range	°C (°F)
	j -210 to +1,200 (-346 to +2,192)
	k -200 to +1,372 (-328 to +2,501)
	t -250 to +400 (-418 to +752)
	n -200 to +1,300 (-328 to +2,372)
	E -150 to +950 (-238 to +1,742)
	R 0 to 1,767 (32 to 3,212)
	S 0 to 1,767 (32 to 3,212)
Resolution	0.1 °C/F < 1,000 °C/F; 1 ° ≥ 1,000 °C/F
Accuracy (50/60 Hz)	0.1 % to 0.2 % + 0.6 ° at 1 ° depending on thermocouple range and type
Sampling rate	8 samples acquired at the storage interval
Storage interval	Programmable from 5 s to 1 day
Storage modes	Start-end, FIFO, XRMT™ extended recording mode and recording on alarms
Recording duration	15 minutes to 8 weeks, programmable using DataView®
Data storage	240,000 measurements (512 kB). The recorded data are stored in non-volatile memory, even if the battery is low or absent
Communication	Optically-isolated USB 2.0
Power supply	2 x 1.5 V LR06 batteries
Battery life	100 hours to > 45 days (depending on recording interval/duration)
Mechanical specifications	
Dimensions	125 x 70 x 32 mm
Weight (with batteries)	200 g
Casing	UL94-V0
Vibration	IEC 60068-2-6 (1,5 mm, 10 to 55 Hz)
Shocks	IEC 60068-2-27 (30 G)
Falls	IEC 60068-2-32 (1 m)
Environment	
Operating temperature	-10 to +50 °C
Storage temperature	-20 to +60 °C

ADDITIONAL INFO

- Automatic report generation

ACCESSORIES / REPLACEMENT PARTS

- SK6 flexible K thermocouple _____ P03652906
- Bag with carrying strap _____ P01298076
- See all the accessories on page 144

CONTENTS

- L642 delivered with:
 - 1 USB cable 2 m long, type A to mini-B 5-pin
 - PC communication software
 - 2 x 1.5 V LR06 batteries

CHOOSE YOUR SOLAR POWER ANALYSER



FTV 100
page 140



FTV 200
page 141

Solar power installation tester	■	
Solar panel tester		■
DC voltage measurement	■	■
DC current measurement	■	■
AC voltage measurement	■	
AC current measurement	■	
Temperature measurement	■	■
Insolation measurement	■	■
Calculation of the installation's overall efficiency	■	
Calculation of inverter efficiency	■	
I / V curve in Standard Test Conditions		■
Library of panels		■
Report software	■	■



FTV 100

Ref.: P01160700



STRENGTHS

- Calculation of solar power installation efficiency
- Testing of solar power installation energy efficiency
- Electrical power survey
- Calculation of DC/AC inverter efficiency
- Simultaneous measurements on 1, 2 or 3 rows of panels installed in parallel

SPECIFICATIONS

FTV 100			
Display	Large 5.7" extra-bright colour digital LCD screen (320 x 240) with anti-reflective treatment		
Inputs	Functions	Range	Accuracy
Pyranometer	Solar irradiance measurement	0 to 2,000 W/m ²	± 2 %
Environmental temperature	Measurement with Pt100 sensor	-30°C to +80°C	± 1 % ± 1 °C
Solar panel temperature	Measurement with Pt100 sensor	-30°C to +120°C	± 1 % ± 1 °C
DC voltage	1 to 3 inputs	1,000 V _{DC}	± 1 %
DC current	1 to 3 inputs	1,400 A _{DC}	± 1 %
AC voltage	1 to 3 inputs	600 V _{AC}	± 1 %
AC current	1 to 3 inputs	3,000 A _{AC}	± 1 %
Functions			
Calculation functions	Efficiency of solar panels with compensation of the modules' temperature coefficient Efficiency of DC/AC conversion by the inverter		
Data logger	Up to 10 instrument configurations pre-recorded in memory (measurements and results)		
Specifications			
Communication	RS232 (remote unit) + USB (PC)		
Internal power supply	Built-in rechargeable Li-Ion battery (4.5 Ah) Battery life 8 hours		
External power supply	230 Vac - 50 Hz external power supply		
Protection	IP67 closed / IP54 open		
Dimensions / weight	360 x 304 x 194 mm / 3 kg		
Electrical safety	IEC 61010-1 - 600 V CAT IV / 1 000 V CAT III		

ADDITIONAL INFO

- Particularly easy to read, even in direct sunlight, thanks to the anti-reflective treatment
- The FTV 100 is also available in a version with 3 DC inputs plus 3 PAC10-FTV DC current clamps and 3 MN-FTV AC clamps — P01160720

CONTENTS

- FTV100 with 1 DC input plus A PAC10-FTV DC current clamp and 3 MN-FTV AC clamps delivered with:
 - 1 IP67 site-proof case
 - 1 pyranometer for insolation with 5 m cable
 - 1 Pt100 sensor for environment temperature with 3 m cable
 - 1 Pt100 sensor for panel temperature with 3 m cable
 - 3 AC current clamps (MN-FTV) with 3 m cable
 - 1 DC current clamp (PAC10-FTV) with 3 m cable
 - 4 x 3 m leads with test probes
 - 1 rechargeable battery with mains adapter
 - Data processing software
 - 1 bag
 - 1 certificate of conformity

ACCESSORIES / REPLACEMENT PARTS

- 3 -DC-input installation measurement kit comprising:
 - 2 PAC current clamps (PAC10-FTV) with 3 m cable,
 - 2 sets of leads with test probes (3 m) P01160710
- GREENTEST FTV100 REMOTE unit comprising:
 - 4 x 1.5 V LR6 batteries,
 - 2 x RS232 M/M connectors for soldering,
 - 1 mounting strap P01160736
- See all the accessories on page 144



FTV 200

Ref. : P01160745

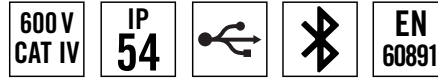

STRENGTHS

- Solar panel testing
- I-V curves of all types of solar panels
- Excellent display resolution: 500 measurement counts per curve with zoom
- Measurement of temperature, solar irradiance, peak power, Voc, Isc, etc.
- The specifications of thousands of types of solar panels are referenced in the integrated library

SPECIFICATIONS

	FTV 200
Screen	4.3" colour graphical LCD touch screen
Library	10,000 curves (with panel reference values / manufacturer)
Functions	
Voltage DC	10 to 1,000 V
Current DC	0.1 to 10 A
Power	10 W to 10 kW
Radiation	By pyranometer / 0 to 2,000 W/m ²
Temperature	by Pt100 - 20°C to +100°C
I-V graph	Graphic display of voltage/current measurement per panel or string
MPP graph	Graphic display of maximum power point (MPP)
General specifications	
Communication	USB 2.0
Power supply / battery life	Mains or rechargeable Li-Ion battery pack / 12 hours on battery
Safety	IEC 61010, CAT III 600 V
Operating temperature	-5°C to +40°C
Dimensions/weight	270 x 250 x 130 mm / 2.5 kg

ADDITIONAL INFO

- The FTV 200 is also available in a complete version delivered with 1 professional pyranometer and a Pt100 sensor P01160740

CONTENTS

- FTV 200 delivered with:
 - 1 bag
 - 1 set of cables 3 m long
 - 1 set of MC4 adapters (red/black)
 - 1 MC4/banana Ø 4 mm adapter
 - 1 magnetic stylus for touch screen
 - 1 USB key
 - 1 mains adapter
 - 1 set of flexible test probes
 - PC software
 - 1 certificate of conformity

ACCESSOIRES / RECHANGES

- Pyranometer P01160730
- Pt100 ambient temperature sensor P01160731
- See all the accessories on page 144



DATA PROCESSING SOFTWARE



DATAVIEW®

Ref. : P01102095

PAT

PAT 2

PEL
TRANSFER

DATA
LOGGER

FUNCTIONS

- Configuration of all the functions of instruments connected to a PC or via Bluetooth®
- Recovery of recorded measurement data
- Backup of measurement files
- Opening of saved files
- Processing and report creation (EN50160)
- Export into an Excel spreadsheet
- Export in .pdf format
- Database management

POWER ANALYZER TRANSFER 2 FOR C.A 8331 / C.A 8336

The PAT 2 module in DataView® offers additional functions:

- Configuration of alarms
- Configuration of transients
- Configuration of trend curves
- Real-time display
- Data recovery, backup and export
- Measurement campaign start after automatic configuration of the associated instrument.

REQUIRED CONFIGURATION

- Windows Vista & Windows 7/8/10 (32/64 bit)
- 1 GB RAM for Windows Vista & Windows 7/8 (32 bit)
- 2 GB RAM for Windows Vista & Windows 7/8 (64 bit)
- 80 MB available hard-disk space (200 MB recommended)

ADDITIONAL INFO

- The **Dataview®** software:
 - Automatically recognizes the instrument connected when it is hooked up to the PC and opens the corresponding menu. Users then have direct access to its configuration and the data stored on it
 - Equipped with a large number of predefined report templates for quick generation in accordance with the applicable standards. Users can also create their own templates to meet their needs and directly add their own comments

DataView® modules	PAT	PAT 2	PEL TRANSFER	DATALOGGER
Associated products	F407	C.A 8331	PEL 102	L 562
	F607	C.A 8333	PEL 103	CL601
	C.A 8220	C.A 8336	PEL 105	L101
	C.A 8230	C.A 8435		L102
				L111
				ML912
				ML914
				AL834
				L261
				L481
			L452	
			L642	

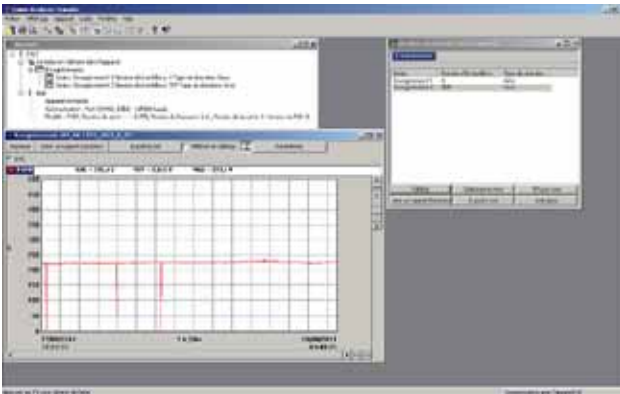

PAT MODULE Display of data stored by an F407 clamp

Paramètre	Unité	Valeur	Unité Appliquée
U1	V	230	V
U2	V	230	V
U3	V	230	V
I1	A	10	A
I2	A	10	A
I3	A	10	A
φ(U1,U2)	°	120	°
φ(U2,U3)	°	120	°
φ(U1,U3)	°	120	°
φ(I1,I2)	°	120	°
φ(I2,I3)	°	120	°
φ(I1,I3)	°	120	°
φ(V1,V2)	°	120	°
φ(V2,V3)	°	120	°
φ(V1,V3)	°	120	°

PAT 2 MODULE Configuration of EN 50160 parameters

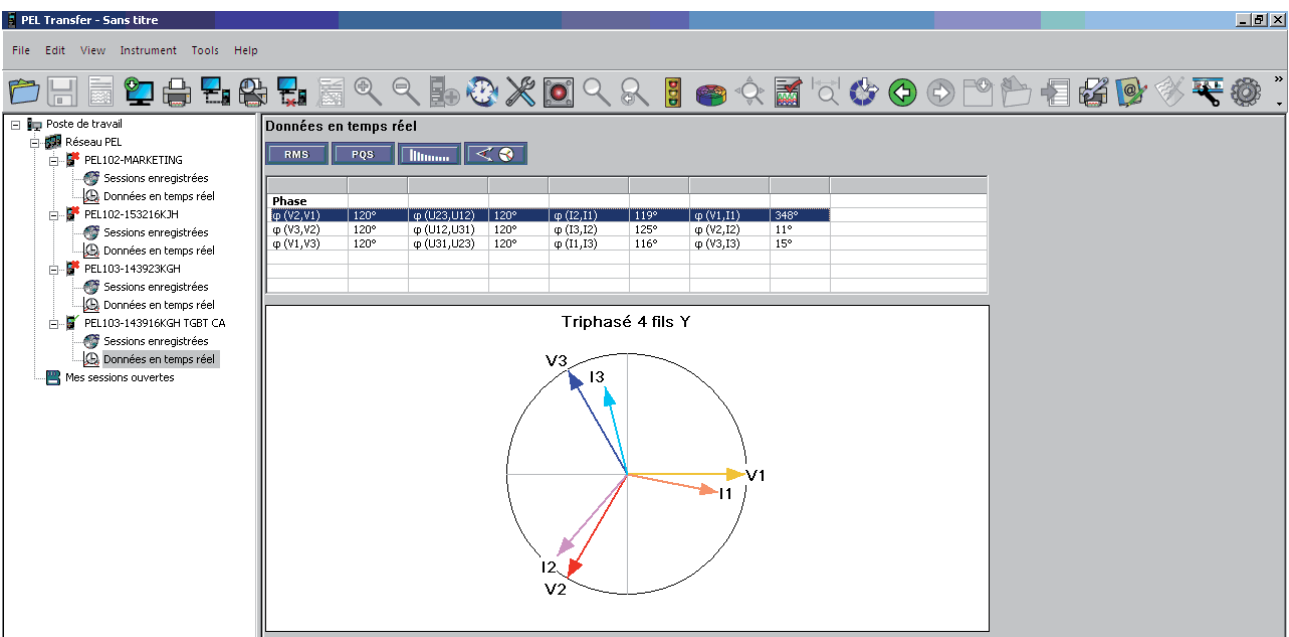

PEL TRANSFER MODULE Remote display of a vectorial representation

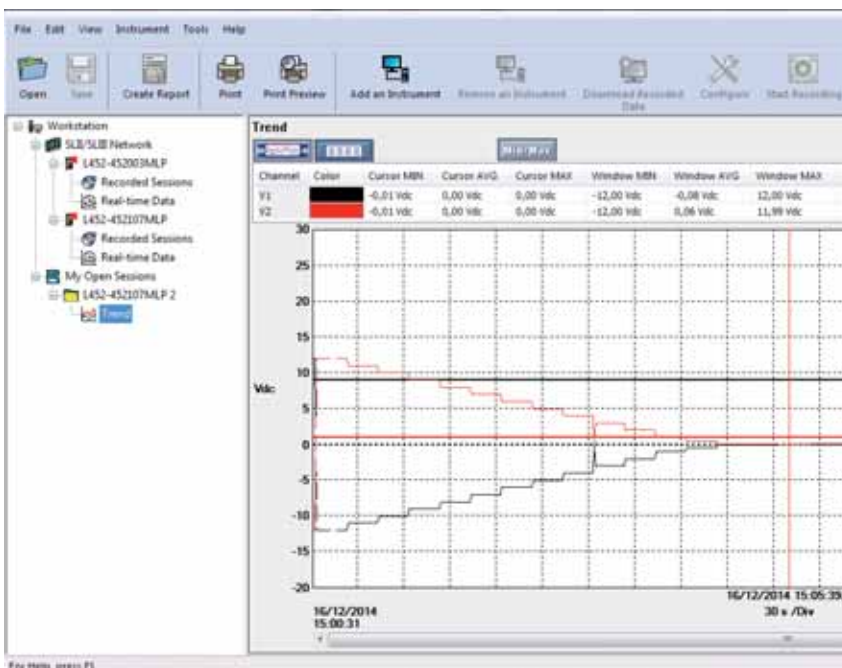

DATA LOGGER MODULE Recording of 0-10V - 2 channels

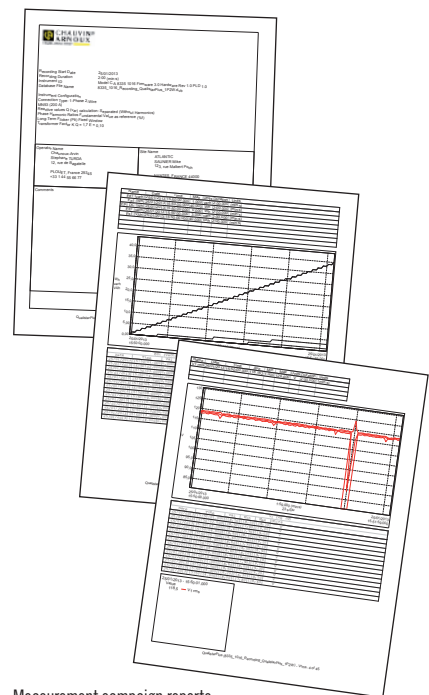









Measurement campaign reports



POWER AND ENERGY QUALITY ANALYSERS AND LOGGERS

C.A 8220, C.A 8230, C.A 8331, C.A 8333, C.A 8336, C.A 8435, PEL 102, PEL 103 and PEL 105

	MODEL	MEASUREMENT RANGE	CLAMPING Ø / LENGTH	IEC 61010	REFERENCE
CURRENT SENSORS	 MN93	500 mA to 200 A _{Ac}	Ø 20 mm	600 V CAT III / 300 V CAT IV	P01120425B
	 MN 93A	5 mA to 100 A _{Ac}	Ø 20 mm	600 V CAT III / 300 V CAT IV	P01120434B
	 MA193-250 MA193-350 MA196-350	100 mA to 10 kA _{Ac}	Ø 70 mm / 250 mm Ø 100 mm / 350 mm Ø 100 mm / 350 mm	1000 V CAT III / 600 V CAT IV	P01120580 P01120567 P01120568
	 PAC93	1 A to 1,000 A _{Ac} / 1 A to 1,300 A _{Dc}	1 x Ø 39 mm or 2 x Ø 25 mm	600 V CAT III / 300 V CAT IV	P01120079B
	 J93	50 A to 3,500 A _{Ac} / 50 A to 5,000 A _{Dc}	Ø 72 mm	600 V CAT III / 1000 V CAT IV	P01120110
	 A193-450 A196A-610	100 mA to 10 kA _{Ac}	Ø 140 mm / 450 mm Ø 190 mm / 610 mm	1000 V CAT III / 1000 V CAT IV	P01120526B P01120554
	 A193-800	100 mA to 10 kA _{Ac}	Ø 250 mm / 800 mm	1000 V CAT III / 600 V CAT IV	P01120531B
	 C193	1 A to 1,000 A _{Ac}	Ø 52 mm	600 V CAT IV	P01120323B
	 E3N	50 mA to 10 A _{Ac/Dc} 100 mA to 100 A _{Ac/Dc}	Ø 11.8 mm	600 V CAT III / 300 V CAT IV	P01120043A

	DESCRIPTION	REFERENCE
OTHER ACCESSORIES	 Kit of 5 banana leads + 5 crocodile clips + 1 set of coloured rings	P01295483
	 Kit of 4 banana leads + 4 crocodile clips + 1 set of coloured rings	P01295476
	 1 set of coloured inserts and rings	P01102080
	 5 A adapter unit	P01101959
	 Reeling box - MultiFix magnetized casing	P01102149
	 USB-A USB-B lead	P01295293
	 Bag no. 22	P01298056
	 DataView® software	P01102095
	 ESSAILEC casing	P01102131



CURRENT SENSORS FOR LOGGERS (EXCLUDING PEL)

	MODÈLE	MEASUREMENT RANGES	OUTPUT SIGNAL	PHASE SHIFT*	MAX. CONDUCTOR SIZE		OUTPUT CONNECTION	COMPATIBLE PRODUCTS	REFERENCE	
		AC	VOLTAGE		Ø CABLE	BUSBAR				
VOLTAGE OUTPUT		E3N	100 mA to 10 A 1 to 100 A	100 mV/A _{AC} 10 mV/A _{AC}	< 1.5°	11.8 mm	–	BNC lead	L101 L102 L562	P01120043A
		MN 60	0.1 to 24 A 0.5 to 240 A	100 mV/A _{AC} 10 mV/A _{AC}	< 2.5°	19.8 mm	–	BNC lead		P01120409
		PAC 12	0.2 to 40 A 0.5 to 400 A	10 mV/A _{AC} 1 mV/A _{AC}	< 1.5°	One cable: 30 mm Two: 24 mm	Two 31,5 x 10 mm	BNC lead		P01120072
		PAC 22	0.2 to 100 A 0.5 to 1,000 A	10 mV/A _{AC} 1 mV/A _{AC}	< 1.5°	One cable: 39 mm Two: 25 mm	One 50 x 12 mm Two 50 x 5 mm	BNC lead		P01120073
		C160	0.1 to 10 A 0.1 to 100 A 1 to 1,000 A	100 mV/A _{AC} 10 mV/A _{AC} 1 mV/A _{AC}	< 1°	52 mm	50 x 5 mm	BNC lead		P01120308
		D38N	1 to 30 A 1 to 300 A 1 to 3,000 A	10 mV/A _{AC} 1 mV/A _{AC} 0,1 mV/A _{AC}	< 1°	64 mm 64 x 100 mm	50 x 135 mm	BNC lead		P01120057A
CURRENT OUTPUT		MN11	0.5 to 240 A	1 mA/A _{AC}	< 2.5°	19.8 mm	–	Wire cable with reinforced or double insulation 1.5 m long and terminated by 2 elbowed male banana safety plugs Ø 4 mm	L111	P01120404
		C103	0.1 to 1,200 A	1 mA/A _{AC}	< 0.5°	52 mm	50 x 5 mm	Wire cable with reinforced or double insulation 1.5 m long and terminated by 2 elbowed male banana safety plugs Ø 4 mm		P01120303

*Maximum rated phase shift



ACCESSORIES / REPLACEMENT PARTS

POWER AND ENERGY QUALITY ANALYSER

C.A 8220

- C.A 1711 tachometer probe _____ P01102082
- 2-wire Pt100 adapter _____ HX0091

C.A 8220 / C.A 8230

- E3N clamp adapter _____ P01102081
- E3N clamp + mains adapter _____ P01120047
- Bag no. 5 _____ P01298049
- Crocodile clips (1 red/1 black) _____ P01102057Z
- Banana/banana leads (1 red/1 black) _____ P01295288Z
- Test probes (1 red/1 black) _____ P01295454Z
- Pack of 6 NiMH rechargeable batteries _____ P01296037
- C.A 82X0 EUR mains power supply _____ P01160640
- Optical/USB cable _____ HX0056Z
- Current measurement lead _____ P03295509
- PAC93 mains adapter _____ P01101967
- DataView® software _____ P01102095
- Set of 2 magnetized test probes (1 red / 1 black) _____ P01103058Z

THREE-PHASE POWER AND ENERGY QUALITY ANALYSER

C.A 8331 / C.A 8333 / C.A 8336 / C.A 8435

- Belt bag no. 21 _____ P01298055
- Screen protection film _____ P01102059
- Qualistar bag no. 06 _____ P01298051
- In-vehicle charger _____ HX0061
- E3N adapter _____ P01102081
- E3N mains power pack _____ P01120047
- Battery pack _____ P01296024
- PA30W mains power pack (C.A 8331-33-35-36) _____ P01102057
- PA31ER mains adapter _____ P01102150
- PAC93 mains adapter _____ P01101967
- DataView® software _____ P01102095
- Set of 2 magnetized test probes (1 red / 1 black) _____ P01103058
- Bag no. 22 _____ P01298067

C.A 8435

- Set of IP65 banana leads 3 m long (x5) _____ P01295479
- Set of rubber caps (5 small + 4 large) _____ P01102117
- Bag no. S21 _____ P01298066

POWER AND HARMONICS MULTIMETER CLAMP

F407, F607

- Set of red/black banana/banana leads _____ P01295451Z
- Set of red/black crocodile clips _____ P01295457Z
- Magnetized MultiFix kit _____ P01102100Z
- Bluetooth kit _____ P01637301
- Bag no. S03 _____ P01298076
- DataView® software _____ P01102095
- Set of 2 magnetized test probes (1 red / 1 black) _____ P01103058Z

POWER AND ENERGY LOGGERS

PEL 102 and PEL 103

- Bag no. 23 _____ P01298078
- E3N adapter _____ P01102081
- MultiFIX _____ P01102100Z
- Mains power cable _____ P01295174
- Mains adapter _____ P01102134
- PAC93 mains adapter _____ P01101967
- DataView® software _____ P01102095
- Set of 2 magnetized test probes (1 red / 1 black) _____ P01103058Z

PEL 105

- Set of rubber caps (5 small + 4 large) _____ P01102147
- Pole mounting kit _____ P01102146
- Crocodile clips kit (x5) _____ P01102099
- E3N adapter _____ P01102081
- Set of IP 67 banana leads 3 m long (x5) _____ P01295479
- DataView® software _____ P01102095
- Bag no. S21 _____ P01298066
- PA30W mains adapter _____ P01102057
- Set of 2 magnetized test probes (1 red / 1 black) _____ P01103058Z

SOLAR POWER ANALYSER

FTV 100 / FTV200

- Pyranometer _____ P01160730
- Pt100 ambient temperature sensor _____ P01160731
- Pt100 contact temperature sensor _____ P01160732
- FTV remote unit _____ P01160736

**FTV 100**

- 3-DC-input installation measurement kit:
2 PAC current clamps (PAC10-FTV) with 3 m cable,
2 sets of leads with test probes (3 m) _____ P01160710
- GREENTEST FTV100 REMOTE unit: 4 x 1.5 V batteries,
2 RS232 M/M connectors for soldering, 1 mounting strap _____ P01160736
- «Cable» communication kit: 1 series cable 15 m long,
RS232 M/M 9-pin connectors _____ P01160737
- «Bluetooth» communication kit: 2 Bluetooth adapters
(transmitter/receiver), 2 RS232 M/F and M/M series cables
20 cm long, adapter programming software _____ P01160738
- PAC10-FTV DC clamp (200 A_{DC}) _____ P01160734
- PAC20-FTV DC clamp (1,400 A_{DC}) _____ P01120092
- MN13-FTV AC clamp (200 A_{AC}) _____ P01160733
- C107-FTV AC clamp (1,000 A_{AC}) _____ P01120337
- D43-FTV AC clamp (3,000 A_{AC}) _____ P01120100
- Set of crocodile clips \varnothing 4 mm (R/B) _____ P01102052Z
- FTV100 rechargeable battery _____ P01160735

SOLAR POWER ANALYSER**FTV 200**

- Bluetooth® FTV-200 communication kit _____ P01160739
- Bag _____ P01298066
- USB/RS232 adapter _____ HX0055
- Inclinator _____ P01102115
- Flexible test probes _____ P01102116
- MC4 (1 red/ 1 black) adapters _____ P01102119

TRMS VOLTAGE/CURRENT LOGGER**L562**

- Standard PVC leads with 4 mm straight male plugs _____ P01295288Z
- 32 A crocodile clips _____ P01102052Z
- Bag with carrying strap _____ P01298076
- USB cable 2 m long, type A to mini-B _____ Contact us
- Banana plug/female BNC adapter _____ P01101846
- DataView® software _____ P01102095

CURRENT LOGGERS**L101 and L102**

- Bag with transport strap _____ P01298076
- USB cable 2 m long, type A to mini-B _____ Contact us
- Mains adapter for E3N clamp _____ P01101965
- DataView® software _____ P01102095

L111

- Standard PVC leads with 4 mm straight male plugs _____ P01295288Z
- 32 A crocodile clips _____ P01102052Z
- Bag with carrying strap _____ P01298076
- USB cable 2 m long, type A to mini-B _____ Contact us
- Mains adapter for E3N clamp _____ P01101965
- Banana plug/female BNC adapter _____ P01101846
- DataView® software _____ P01102095

ML912

- Bag with carrying strap _____ P01298076
- USB cable 2 m long, type A to mini-B _____ Contact us
- DataView® software _____ P01102095

ML914 et AL 834

- DataView® software _____ P01102095
- Bag no. 23 _____ P01298078

VOLTAGE LOGGERS**L261 and L481**

- Standard PVC leads with 4 mm straight male plugs _____ P01295288Z
- 32 A crocodile clips _____ P01102052Z
- Bag with carrying strap _____ P01298076
- USB cable 2 m long, type A to mini-B 5-pin _____ Contact us
- Banana plug/female BNC adapter _____ P01101846
- DataView® software _____ P01102095

PROCESS DATA LOGGER**L452**

- DataView® software _____ P01102095
- μ USB power cable _____ P01102148
- Wall mount _____ P01651024
- MultiFix mounting adapter _____ P01102100Z
- Screw connector kit (x 5) _____ P01295489

TEMPERATURE LOGGER**L642**

- SK6 flexible K thermocouple sensor _____ P03652906
- Bag with carrying strap _____ P01298076
- USB cable 2 m long, type A to mini-B _____ Contact us
- DataView® software _____ P01102095

FIND ALL OUR ACCESSORIES ON PAGE 230



CHAUVIN ARNOUX C.A 1950 DiaCam 2
IR CAMERA IP 54

F1 F2 F3

▲ ▲ ▲

⏻





PHYSICAL & ENVIRONMENTAL MEASUREMENTS

Info and advice

150

Calibrators

154

Thermal cameras

157

Thermometers

164

Other physical & environmental measuring instruments

172

Accessories

188



TEMPERATURE MEASUREMENT

Thermometers have always been essential instruments, used by all industrial companies for:

- Ambient temperature measurement.
- Control of the temperature in a cold room or climatic chamber.
- Temperature measurement on partitions.
- Verification of the hot spots in a an electrical cabinet.
- Verification of foodstuff freshness by inserting a probe in the heart of the product

THERMOCOUPLES

The operating principle of thermocouples is based on the **electromotive force created naturally between two conductor wires of different materials joined at the end** (SEEBECK effect). This electromotive force depends on the temperature to which one of the two junctions is exposed. This temperature is measured as a voltage of a few millivolts. A thermocouple is therefore composed of two junctions (or welds) linking two different metals or alloys. One of the junctions, positioned at the point of measurement, is called the hot junction, while the other is called the cold junction and its known temperature serves as the reference. For two given materials or alloys, there is a relation between the electromotive force and the reference and measurement temperatures. This relation is usually **expressed** by a characteristic curve of **sensitivity in mV/°C**.

RESISTIVE PROBES

Some pure metals have a coefficient of resistivity which varies as a function of temperature in a reproducible way. The metals generally used are platinum and copper. Currently, the widest-used type is platinum, with a resistance of 100 Ω at 0 °C.

OPTICAL OR NO-CONTACT MEASUREMENTS

All bodies emit electromagnetic radiation whose spectrum has an energy distribution which is a function of temperature.

This measurement system offers **quick temperature testing on parts which are current-carrying, moving or difficult to access**. It can also be used for measurements of very high temperatures or on poor heat conductors such as ceramics or synthetic materials.

Chauvin Arnoux offers easy-to-use electronic thermometers which are rugged and accurate:

- Thermocouple thermometers.
- Resistive-probe thermometers.
- No-contact thermometers.
- Thermal cameras.

CHOOSING THE RIGHT TEMPERATURE MEASUREMENT SYSTEM

Three types of measurement are used to measure temperature:

- Measurement by penetration (semi-solids, pasty samples, etc.) and by immersion (liquids).
- Ambient measurement (air, gas).
- Surface measurement (solid bodies).

For the latter type, users can choose a system with or without contact, depending on the application involved. The type of application will determine the instrument and the probe chosen.

In general, thermocouples offer quick response times and wide measurement ranges. Sensors with resistive probes are usually slower, but they are also more accurate.

The sensor selection criteria will depend on:

- the milieu and the operating environment.
- the temperature range.
- the required accuracy.
- the response time.





INFRARED THERMOGRAPHY

Infrared thermography detection technology has become irreplaceable for ensuring safe conditions for industrial production. Infrared thermal imaging is a no-contact, real-time inspection method for production equipment subject to high voltages, powerful electric currents or high operating speeds.

For this detection method, there is no need to cut off the current, shut down the machines or stop production. It can be used to troubleshoot any latent malfunctions in advance and thus prevent failures and avoid production incidents.

ELECTRICAL MAINTENANCE

The purpose of this sort of inspection is to detect any overheating in working electrical systems due to various causes: poor connections, overloads, phase unbalance, faulty contacts, etc. This helps to prevent and avoid costly equipment damage, production shutdowns, operating losses, fires, etc.

The aim is to help with decision-making for corrective action, to prevent incidents, to anticipate any works which might be necessary and to facilitate electrical installation maintenance (time saving and safety).

MECHANICAL MAINTENANCE

Moving mechanical parts heat up quite normally due to friction. Infrared thermography reveals abnormal overheating due to wear, misalignment, lubrication problems, etc.

It is used to complement vibratory analysis, which is much more time-consuming to set up.

A single image gives a full health report on the electric motor, its power supply (cables), the bearings and, if necessary, the alignment.

BUILDING THERMICS

These applications of infrared thermography concern architects, heating and sanitary installers, heating operators, electricians, property companies, property experts, owners and insurers.

With an infrared camera, it is easy to view the distribution of heat on the front of a building and it also possible to precisely locate heat losses due to faulty insulation. This helps to produce a thermal survey of the building.

Thermal imaging is an **innovative technique for safe, reliable and quick “no-contact” assessment.**

A thermal camera does not measure temperatures but radiation fluxes. Once the operator has adjusted certain parameters, the camera calculates the temperatures of the target. It then provides the user with a map of the temperatures, called a thermogram: each temperature is represented by a different colour.

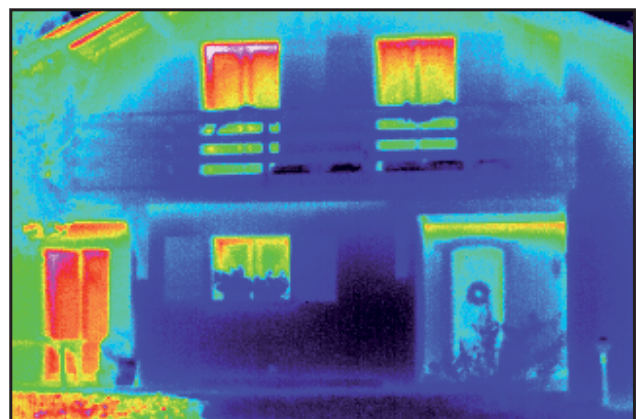
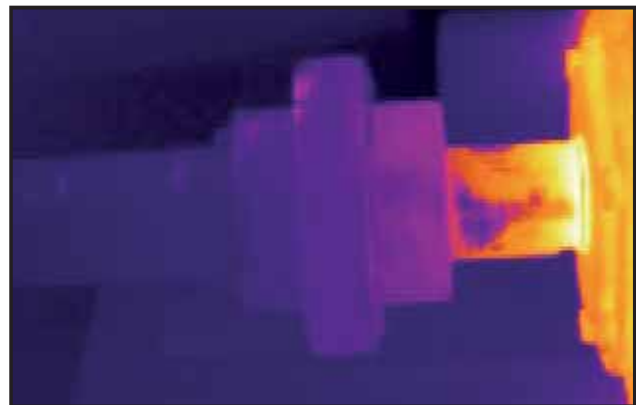
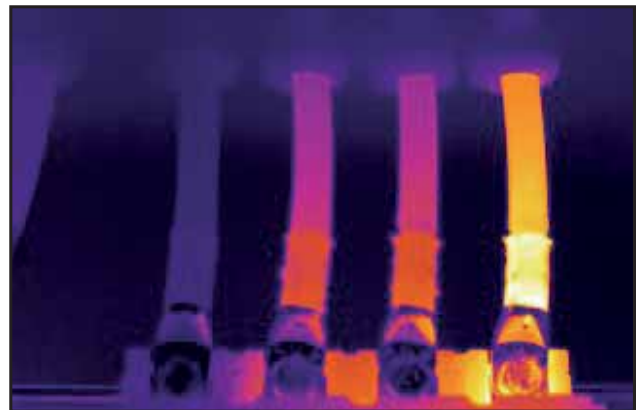



INDOOR AIR QUALITY

Whether in places open to the public (transport, government offices, schools or hospitals), workplaces or private areas, our lifestyles mean we spend most of our time indoors. Human activities and products used in construction, decoration and furniture (paint, floor and wall coverings,

varnishes, etc.) are all sources of contamination emitting substances into the air. The issue of indoor air quality has only been raised recently, but it is a major concern because it affects everyone.

CARBON DIOXIDE (CO₂)

Carbon dioxide is a colourless, odourless gas produced by the combustion of carbon-based materials such as wood, oil, coal and their derivatives. It is also produced by humans' and animals' respiration. Plants, however, actually extract CO₂ from the air during photosynthesis, thus contributing to the natural balance.

Nevertheless, the level of CO₂ in outdoor air is increasing. This gradual increase began with the industrial revolution and the growing use of fossil fuels.

WHY MEASURE IT?

Indoors, CO₂ is representative of a level of confinement indicating an accumulation of pollutants in the premises and insufficient air renewal. Links have been found between poor ventilation, leading to high levels of CO₂, and reduced

performance by children in tests involving logic, reading and calculations.

Concentrations above 1,000 ppm already cause sleepiness, difficulty in concentrating and even headaches.





THRESHOLD VALUES

In volume terms, the proportion of CO₂ in the air is 0.0375%, or 375 ppmv (parts per million by volume). In urban environments, it may be as high as 500 ppm.

- 500 to 1,000 ppm - Indoor air quality: Good
- 1,000 ppm - Certain studies have shown an increase in asthma-related symptoms among children on average over a school day
- 1,500 to 2,500 ppm - Indoor air quality: Poor (1,500 ppm is the regulatory limit usually specified, particularly for educational premises in the United Kingdom, Germany and Austria)
- 2,500 to 5,000 ppm - Symptoms: headache, fatigue and loss of concentration
- 5,000 ppm - Average concentration over 8 hours - Occupational Exposure Limit in France and elsewhere

MEASUREMENT PRINCIPLE

The method used by the C.A 1510 to measure CO₂ levels is an NDIR (Non-Dispersive InfraRed) method.

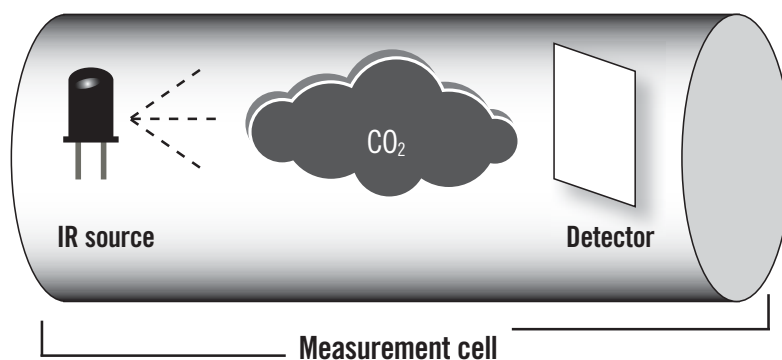

CO₂ and other gases absorb IR radiation in a “specific” way.

- 1 source emits an IR signal in a predefined cavity
- The CO₂ absorbs part of the light in the near-IR spectrum, thus reducing the intensity of the signal
- The IR detector measures the intensity of the signal received at the absorption wavelength of carbon dioxide. The Beer-Lambert Law establishes the relationship between the signal intensity and the gas concentration.

SENSOR POSITIONING AND RECOMMENDATIONS

The measuring instrument should preferably be positioned between 50 cm and 2 m from the ground. In practice, it should be set up in a safe place with access to a power socket if necessary.

The instrument should be kept at least 50 cm away from any intense heat sources (heating) and should be kept out of direct sunlight. The instrument must not be placed in

the direct flow of air from outside (windows) or close to the entrance. The CO₂ level varies during the day, depending on how many people are present, the activities involved and the efficiency of the air renewal system; for these reasons, functions for recording and for indicating any threshold overruns are crucial.



CHOOSE YOUR CALIBRATOR



C.A 1621
page 155



C.A 1623
page 155



C.A 1631
page 156

Measurement / Simulation			
J, K, T, E, R, S, B and N thermocouples	<input checked="" type="checkbox"/>		
Resistive probes Pt10, Pt50, Pt100, Pt200, Pt500, Pt1000		<input checked="" type="checkbox"/>	
4-20 mA			<input checked="" type="checkbox"/>
0-10 V			<input checked="" type="checkbox"/>
Voltage			
Up to 100 mV	<input checked="" type="checkbox"/>		<input checked="" type="checkbox"/>
Up to 20 V			<input checked="" type="checkbox"/>
Current			
Up to 24 mA			<input checked="" type="checkbox"/>
Resistance			
0.00 to 3,200.0		<input checked="" type="checkbox"/>	



C.A 1621 - C.A 1623

Ref.: P01654621

P01654623



STRENGTHS

- Large screen for easier reading
- Instrument calibration without removing the sensors
- Comfortable handling due to its dimensions (205x97x45 mm) and weight (472 g)

C.A 1621: thermocouple-probe temperature calibrator capable of measuring and simulating:

- up to 8 types of thermocouple: J, K, T, E, R, S, B and N
- a voltage in mV

C.A 1623: resistive-probe temperature calibrator capable of measuring and simulating:

- up to 7 types of resistive probes: Pt 10, Pt 50, Pt 100, Pt 200, Pt 500, Pt 1000, Pt 100(JIS)
- a resistance

SPECIFICATIONS

C.A 1621				
Input/output range		Resolution		Accuracy
-10 mV ... 100 mV		0.01 mV		± 0.025 % + 2 counts
Function	Range	Resolution	Accuracy	Ref. junction error
Type J	-200 ... +1,200 °C	0.1°C	± (0.3 °C + 10 µV)	± 0.3 °C
Type K	-200 ... +1,370 °C	0.1°C	± (0.3 °C + 10 µV)	± 0.3 °C
Type T	-200 ... +400 °C	0.1°C	± (0.3 °C + 10 µV)	± 0.3 °C
Type E	-200 ... +950 °C	0.1°C	± (0.3 °C + 10 µV)	± 0.3 °C
Type R	-20 ... +1,750 °C	1°C	± (1 °C + 10 µV)	± 0.3 °C
Type S	-20 ... +1,750 °C	1°C	± (1 °C + 10 µV)	± 0.3 °C
Type B	+600 ... +1,800 °C	1°C	± (1 °C + 10 µV)	± 0.3 °C
Type N	-250 ... +1,300 °C	0.1°C	± (0.3 °C + 10 µV)	± 0.3 °C

C.A 1623					
Range		4-wire measurement accuracy ± Ω	Simulation accuracy ± Ω	Acceptable excitation mA	
0.00 Ω ... 400.0 Ω		0.1	0.15	0.1 ... 0.5	
400.0 Ω ... 1,500.0 Ω		0.5	0.5	0.5 ... 3.0	
1,500.0 Ω ... 3,200.0 Ω		1	1	0.05 ... 0.4	
		2			
Mode	Range	Accuracy in °C			
		4-wire input	2-wire / 3-wire input	Output	Excitation admissible mA
Pt10 385	-200 ... +800 °C	0.1 ... 3.0			0.1 ... 3.0
Pt50 385	-200 ... +800 °C	0.7	1.0	0.7	0.1 ... 3.0
Pt100 385	-200 ... +800 °C	0.33	0.5	0.33	0.1 ... 3.0
Pt200 385	-200 ... +250 °C	0.2	0.3 1.6	0.2 0.8	0.1 ... 3.0
Pt500 385	+250 ... +630 °C	0.8	0.3	0.3 0.4	0.05 ... 3.0
Pt1000 385	-200 ... +500 °C	1.6	0.4 0.5	0.2 0.2	0.1 ... 3.0
Pt100 JIS	+500 ... +630 °C	0.3	0.5	0.3	0.1 ... 3.0

ADDITIONAL INFO

- Power supply via optional mains lead:
- Input: 100 V/240 V - 50/60 Hz - 1.8 A
- Output: 12 Vdc, 2 A max
- Battery-powered (6 x 1.5 V supplied) or via mains lead (option)

CONTENTS

- 1 calibrator
- 1 soft case
- 6 x 1.5 V LR06 batteries
- **C.A 1621** delivered with 2 additional thermocouple adapters
- **C.A 1623** delivered with 2 additional test leads and 2 additional crocodile clips

ACCESSORIES / REPLACEMENT PARTS

- Mains power cable P01103057
- MultiFix bag - 120x245x60 mm P01298075
- See all the accessories on page 188

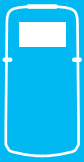

C.A 1631

Ref. : P01654402

STRENGTHS

- Voltage/current process signal calibrator used to measure or supply:
 - a 0 - 24 mA DC current loop
 - a 0 - 20 V DC voltage

SPECIFICATIONS

C.A 1631		
Calibre	Resolution	Accuracy \pm (% of reading + counts)
100 mV	0.01 mV	0.02% + 3
20 V	0.001 V	0.02% + 3
Input impedance: 2 M Ω (rated value), < 100 pF Protection against overvoltages: 30 V - Current supplied at 20 V: 1 mA		
Calibre	Resolution	Accuracy \pm (% of reading + counts)
24 mA	0.001 mA	0.015% + 3
Protection against overloads: 125 mA 250 V quick-response fuse Percentage display: 0% = 4 mA 100% = 20 mA Source mode: 1,000 Ω load at 20 mA for a battery voltage \geq 6.8 V (700 Ω at 20 mA for a battery voltage between 5.8 and 6.8 V) Simulation mode: external loop voltage condition: 24 V (rated value), 30 V maximum, 12 V minimum.		
Loop voltage power supply: 24 V \pm 10 %		

ADDITIONAL INFO

- Power supply via optional mains lead:
- Input: 100 V/240 V - 50/60 Hz - 1.8 A
- Output: 12 Vdc, 2 A max
- Powered by batteries (6 x 1.5 V supplied) or via mains lead (option)

CONTENTS

- 1 calibrator
- 1 soft case
- 6 x 1.5 V LR06 batteries
- 2 test leads
- 2 crocodile clips
- 2 test probes

ACCESSORIES / REPLACEMENT PARTS

- Mains power cable P01103057
- MultiFix bag - 120x245x60 mm P01298075
- See all the accessories on page 188



C.A 1950
page 158



C.A 1882
page 160



C.A 1886
page 161



C.A 1888
page 162

Detectors				
80 x 80	<input checked="" type="checkbox"/>			
160 x 120		<input checked="" type="checkbox"/>	<input checked="" type="checkbox"/>	
384 x 288				<input checked="" type="checkbox"/>
Thermal sensitivity (N.E.T.D)				
0.08°C @ 30°C	<input checked="" type="checkbox"/>	<input checked="" type="checkbox"/>	<input checked="" type="checkbox"/>	
0.05°C @ 30°C				<input checked="" type="checkbox"/>
Temperature range				
-20°C to +250°C	<input checked="" type="checkbox"/>	<input checked="" type="checkbox"/>		
-20°C to +600°C			<input checked="" type="checkbox"/>	<input checked="" type="checkbox"/>
1,000°C / 1,500°C (option)			<input checked="" type="checkbox"/>	<input checked="" type="checkbox"/>
Display mode				
Thermal image	<input checked="" type="checkbox"/>	<input checked="" type="checkbox"/>	<input checked="" type="checkbox"/>	<input checked="" type="checkbox"/>
Real image and merge	Merge via software	<input checked="" type="checkbox"/>	<input checked="" type="checkbox"/>	<input checked="" type="checkbox"/>
Display	2.8 inches	3 inches	3.5 inches	3.5 inches
Analysis functions				
Manual cursor	1	1	3	3
Min / Max on area	<input checked="" type="checkbox"/>	<input checked="" type="checkbox"/>	<input checked="" type="checkbox"/>	<input checked="" type="checkbox"/>
Average on area			<input checked="" type="checkbox"/>	<input checked="" type="checkbox"/>
Isotherm	<input checked="" type="checkbox"/>		<input checked="" type="checkbox"/>	<input checked="" type="checkbox"/>
Temperature profile	<input checked="" type="checkbox"/>		<input checked="" type="checkbox"/>	<input checked="" type="checkbox"/>
Temperature differential		<input checked="" type="checkbox"/>	<input checked="" type="checkbox"/>	<input checked="" type="checkbox"/>
Alarms			<input checked="" type="checkbox"/>	<input checked="" type="checkbox"/>
Correction parameters				
Emissivity, environmental temp., relative humidity, distance	<input checked="" type="checkbox"/>	<input checked="" type="checkbox"/>	<input checked="" type="checkbox"/>	<input checked="" type="checkbox"/>
Others				
CNPP Approval			<input checked="" type="checkbox"/>	<input checked="" type="checkbox"/>
Wide-angle or telephoto lenses available as options			<input checked="" type="checkbox"/>	<input checked="" type="checkbox"/>
Analysis and report creation software	<input checked="" type="checkbox"/>	<input checked="" type="checkbox"/>	<input checked="" type="checkbox"/>	<input checked="" type="checkbox"/>



THERMAL CAMERAS

C.A 1950

Ref. : P01651901



STRENGTHS

- 13-hour battery life and startup in only 3 seconds
- Withstands falls of up to 2 m without interrupting operation
- Focus-free with 20° x 20° field of view
- Voice annotation for recording your comments directly on the image (earphone supplied)
- Connectivity with current clamps and multimeters

ADDITIONAL INFO

- Recording of thermal image and real image simultaneously. Image merge function available via the CAMReport software supplied
- Large number of measurement tools: manual cursor, automatic detection, temperature profile, etc.
- Built-in brightness sensor

CONTENTS

- C.A 1950 delivered in site-proof hard case with:
 - 4 x NiMH batteries
 - 1 battery charger
 - 1 x 2 GB micro SD HD card
 - 1 USB cable
 - 1 Bluetooth® earphone
 - 1 CD-ROM containing the CAMReport software
 - 1 measurement report

SPECIFICATIONS

		C.A 1950
Detector		80 x 80
Type		UFFPA microbolometer, 8 ~14 µm
Frequency		9 Hz
Sensitivity (N.E.T.D)		80 mK @ 30 °C (0.08 °C @ 30 °C)
Temperature measurement		
Temperature range		-20 °C to +250 °C
Accuracy		±2 °C or ±2 % of reading
Imaging performance (thermal image)		
Field of view		20° x 20°
IFOV (spatial resolution)		4.4 mrad
Focus		Fixed
Minimum focal distance		40 cm
Real image		Yes (320 x 240 pixels)
Display mode		Thermal image, real image with automatic parallax compensation. Image merge available with PC software
Analysis functions		
Measurement tools		1 manual cursor + 1 automatic detection + Min Max on adjustable area + Temperature profile + Isotherm
Parameter settings		Emissivity, environmental temperature, distance, relative humidity
Voice comments		Yes by Bluetooth® (earphone supplied)
Connectivity		F407, F607, MTX 3292 and MTX 3293 clamps
Data storage		On 2 GB removable micro SD card (approx. 4,000 images), up to 32 GB
Image format		.bmp (thermal and real images recorded simultaneously)
Image presentation		
Adjustment		Automatic or manual adjustment of palette min/max
Image hold		Animated or fixed image
Image display		Multi-palette
Screen		2.8 inches
Power supply		
Type		Rechargeable NiMH batteries with low self-discharge
Recharging		External (charger supplied)
Battery life		13 hrs 30 min (typical) / 50 % brightness, Bluetooth® off
Environmental specifications		
Operating temperature		-15 °C to +50 °C (-4 °F to +122 °F)
Storage temperature range		-40 °C to +70 °C (-40 °F to +158 °F)
Humidity		10 % to 95 %
Compliance with standards		EN 61326-1 : 2006 / EN 61010-1 Ed. 2
Fall resistance		2 metres on all surfaces
Shock resistance		25 G
Vibration resistance		2 G
Physical specifications		
Weight /dimensions		700 g with rechargeable batteries / 225 x 125 x 83
Ingress protection		IP 54
Interfaces		- USB link and Mass Storage: the product is then recognized as a USB key for easy image transfer - Bluetooth for connectivity with earphone (voice comments) and Chauvin Arnoux® Metrix® measuring instruments (F407, F607, MTX 3292, MTX 3293)
Tripod mounting		Yes, ¼" insert on camera
General specifications		
Report creation software		Supplied as standard with automatic report generation in .pdf or .docx (Word) format / Compatible with W7, W8, 32 and 64 Bits
Warranty		2 years



C.AmReport

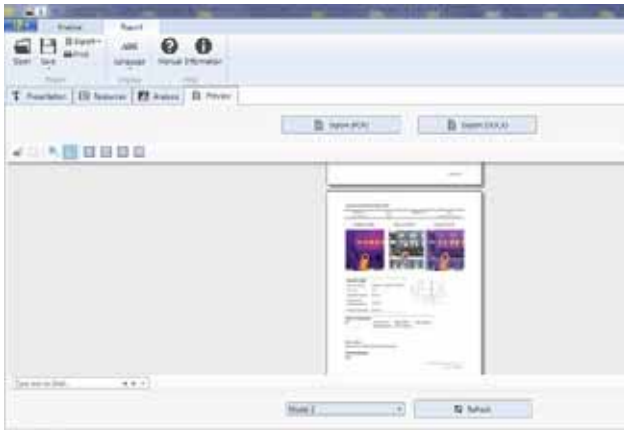

STRENGTHS

- Dedicated to the C.A 1950 thermal camera
- Supplied as standard at no additional cost
- Complete, with all the functions needed for reliable analysis of the measurement results
- Automatic creation of analytical reports which can be exported in Word or pdf format.

REQUIRED CONFIGURATION

WINDOWS XP :

- SP3 minimum
- 850 MB RAM for 32 bit
- 2 GB for 64 bit
- NET Framework 4.0 minimum
- Monitor resolution: super VGA (800 x 600) or higher

WINDOWS VISTA / 7 / 8 / 10 :

- SP1 minimum
- 850 MB RAM for 32 bit
- 2 GB for 64 bit
- NET Framework 4.0 minimum

PRECISE ANALYSIS TOOLS

- Cursors (automatic display of the temperature at the selected point)
- Thermal profile (automatic display of the Min/Max/Avg temperatures of the line)
- A square or circle for area analysis
- Polygons and polylines for more precise analysis of certain areas in the thermogram
- Results tables quickly and automatically display all the information
- Recovery of the voice comments or related measurements
- Automatic merging of the thermal and real images recorded simultaneously
- Automatic report creation for export in .pdf or .docx format

AVAILABLE LANGUAGES

- French, English, German, Spanish, Italian , Dutch, Polish, Romanian, Czech, simplified Chinese, Portuguese, Swedish, Finnish

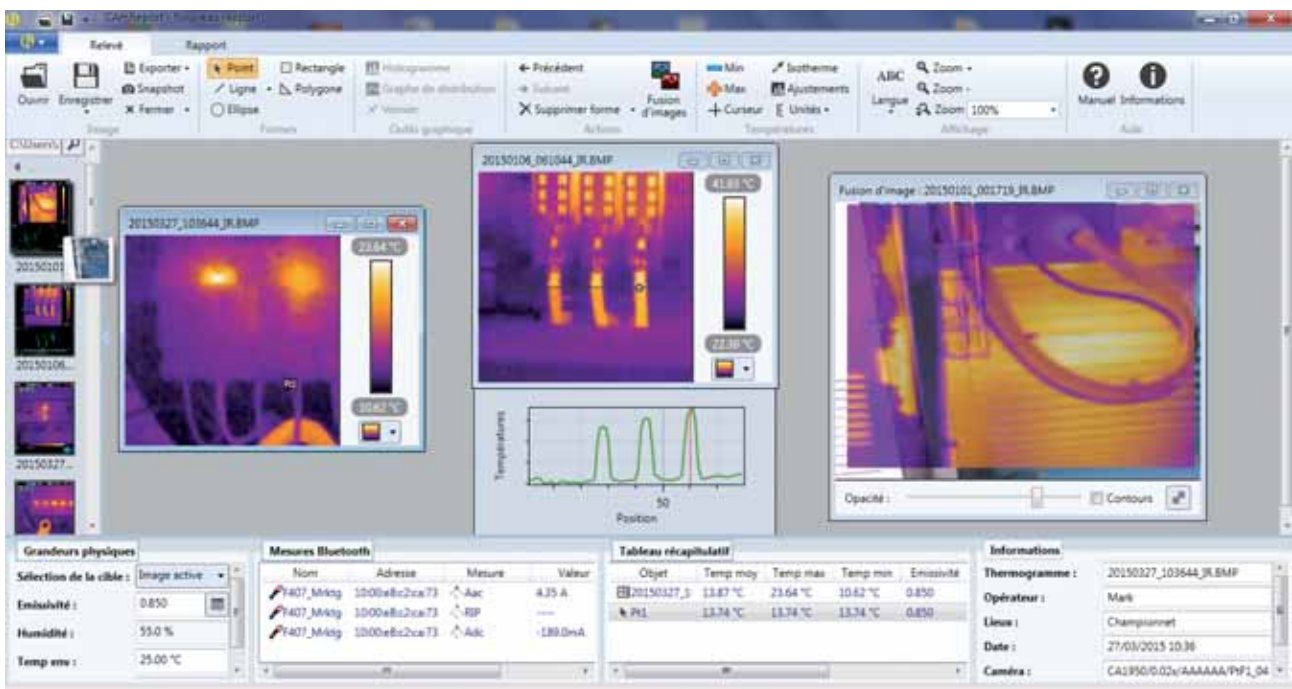



C.A 1882

Ref. : P01651215

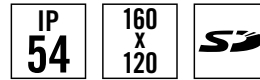

STRENGTHS

- Wide-angle lens
- MixVision cursor for linking a thermogram to a real image
- Manual cursor and automatic detection of hot/cold points
- Wide dynamic range for measurement: -20 °C to +250 °C
- Recording of up to 1,000 thermograms on 2 GB SD card

SPECIFICATIONS

		C.A 1882
Detector		160 x 120
Type		UFPA microbolometer, 8-14 µm
Frequency		50 Hz*
Sensitivity (N.E.T.D)		0.08 °C @ 30 °C
Temperature measurement		
Temperature range		-20 °C to +250 °C
Accuracy		±2°C or ±2% of reading
Image performance		
Thermal image		
Field of view		38° x 28°
Spatial resolution		4.4 mrad
Min. focal distance.		10 cm
Focus		Manual
Real image		Yes
"MixVision" mode		Merge function with adjustment of percentage of thermal image in real image from 0 to 100%
Image size		640 x 480 pixels
Functions		
Parameter settings		Emissivity, environmental temperature, distance, relative humidity
Measurement tools		1 manual cursor + 1 automatic Min/Max detection on adjustable area
Laser pointer		Yes
Data storage		1,000 thermal images as standard
Type of storage		2 GB removable SD card (as standard), up to 16 GB
Multi-directional screen		3 inches
General specifications		
Battery		Rechargeable Lithium-Ion battery / Batt. life: 3 hours
Battery recharging		Recharging via external charger
Protection		IP54

*9 Hz outside the European Union

ADDITIONAL INFO

- The C.A 1882 camera is delivered as standard with its docking station equipped with a video output
- An SD card reader is supplied with the camera
- The screen is totally multi-directional so that it can be used whatever the environment
- A 9 Hz version is available with the reference P01651215E

CONTENTS

- C.A 1882
- 1 neutral box
- 1 battery charger
- 1 docking station
- 1 battery
- 1 x 2 GB SD card
- 1 SD card reader
- 1 video cable
- 1 CD-ROM containing the RayCam Report software

ACCESSORIES / REPLACEMENT PARTS

- Battery P01296045
- Battery charger P01296046
- See all the accessories on page 188



C.A 1886

Ref. : P01651260



STRENGTHS

- 160 x 120 matrix
- Sensitivity: 0.08 °C at 30 °C
- Temperature up to 600 °C as standard
- Large, multi-directional 3.5" screen for easier reading
- MixVision function which links a thermogram to a real image

SPECIFICATIONS

C.A 1886	
Detector	160 x 120, refresh rate: 50 Hz
Type	UFPA microbolometer, 8-14 microns
Sensitivity (NETD)	0.08 °C @ 30°C
Temperature	-20 °C to +600 °C as standard Up to 1,500 °C as an option
Accuracy	±2 °C or ±2%
Optics	Field of view: 20° x 15°, IFOV: 2.2 mrad Min. focal distance: 10 cm
"MixVision" mode	Merge function with adjustment of percentage of thermal image in real image from 0 to 100%
Image size	640 x 480 pixels
Adjustment	Emissivity, environmental temperature, distance, humidity
Measurement tools	3 manual cursors + 1 auto. Max/Min/Avg detection on area, isotherm, temperature differential, temperature profile
Data storage	1,000 images (radiometric format) in 250 folders + 2 GB on mini-SD card
Power supply	Battery life: 3 hrs (continuous use) Recharging via external charger

CONTENTS

- C.A 1886 delivered in a case with:
 - 1 battery charger
 - 2 batteries
 - 1 x 2 GB mini SD card
 - 1 SD card reader
 - 1 video cable
 - 1 CD-ROM containing the RayCam Report software
 - 1 measurement report

ACCESSORIES / REPLACEMENT PARTS

- Sun shade [P01651531](#)
- Photo tripod adapter [P01651526](#)
- See all the accessories on page 188

LENSES FOR C.A 1886

Lenses	IFOV spatial resolution		0.1 m	0.3 m	0.5 m	1 m	2 m	10 m	30 m	100 m
6.4° x 4.8° 3 x telephoto lenses	0.7 mrad	HFOV	0.01	0.03	0.05	0.11	0.22	1.11	3.35	11.18
		VFOV	0.008	0.024	0.04	0.08	0.16	0.83	2.51	8.38
		IFOV	0.07	0.21	0.34	0.69	1.39	6.98	20.96	69.88
20° x 15° standard lens	2.2 mrad	HFOV	0.03	0.10	0.17	0.35	0.70	3.52	10.57	35.26
		VFOV	0.02	0.07	0.13	0.26	0.52	2.63	7.89	26.33
		IFOV	0.22	0.66	1.10	2.20	4.40	22.04	66.12	220.40
38° x 28.5° 0.5 x wide-angle lens	4.4 mrad	HFOV	0.06	0.20	0.34	0.68	1.37	6.88	20.65	68.86
		VFOV	0.05	0.15	0.25	0.50	1.01	5.07	15.23	50.79
		IFOV	0.43	1.29	2.15	4.30	8.60	43.04	129.12	430.40

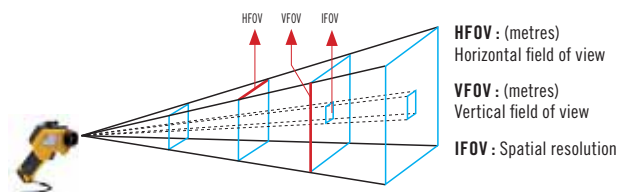

ADDITIONAL INFO

- The C.A 1886 thermal camera is available in other configurations:
- C.A 1886 with 1,000 °C high-temperature option [P01651261](#)
 - C.A 1886 with 1,500 °C high-temperature option [P01651262](#)
 - C.A 1886 Bluetooth [P01651263](#)
 - RayCam Report software supplied for area analysis (polygons or polylines) and studying the temperature distribution on a histogram



C.A 1888

Ref. : P01651270

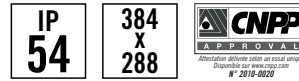

STRENGTHS

- 384 x 288 matrix
- Sensitivity: 0.05 °C @ 30 °C
- Temperature up to 600 °C as standard
- Large multi-directional 3.5" screen for easier reading
- MixVision which links a thermogram to a real image

SPECIFICATIONS

C.A 1888	
Detector	384 x 288, refresh rate: 50 Hz
Type	UFPA microbolometer, 8-14 microns
Sensitivity (NETD)	0.05 °C @ 30 °C
Temperature	-20 °C to +600 °C as standard Up to 1,500 °C as an option
Accuracy	±2 °C or ±2 %
Optics	Field of view: 24° x 18°, IFOV: 101 mrad Min. focal distance: 10 cm
"MixVision" mode	Merge function with adjustment of percentage of thermal image in real image from 0 to 100%
Image size	640 x 480 pixels
Adjustment	Emissivity, environmental temperature, distance, humidity
Measurement tools	3 manual cursors + 1 auto. Max/Min/Avg detection on area, isotherm, temperature differential, temperature profile
Mémoire Data storage	1,000 images (radiometric format) in 250 folders + 2 GB on mini-SD card
Power supply	Battery life: 3 hrs (continuous use) Recharging via external charger

CONTENTS

- C.A 1888 delivered in a case with:
 - 1 battery charger
 - 2 batteries
 - 1 x 2 GB mini SD card
 - 1 SD card reader
 - 1 video cable
 - 1 CD-ROM containing the RayCAM Report software
 - 1 measurement report

ACCESSORIES / REPLACEMENT PARTS

- Sun shade [P01651531](#)
- Photo tripod adapter [P01651526](#)
- See all the accessories on page 188

LENSES FOR C.A 1888

Lens	IFOV spatial resolution	Distance (m)									
		0.1 m	0.3 m	0.5 m	1 m	2 m	6 m	10 m	30 m	100 m	
12° x 9° Telephoto lens	0.55 mrad	HFOV	0.02	0.06	0.11	0.21	0.42	1.27	2.11	6.34	21.12
		VFOV	0.02	0.05	0.08	0.16	0.32	0.95	1.58	4.75	15.84
		IFOV	0.055	0.17	0.28	0.55	1.10	3.30	5.50	16.50	55.00
24° x 18° Standard lens	1.1 mrad	HFOV	0.05	0.15	0.25	0.50	1.00	3.00	4.99	14.98	49.92
		VFOV	0.04	0.11	0.19	0.37	0.75	2.25	3.74	11.23	37.44
		IFOV	0.13	0.39	0.65	1.30	2.60	7.80	13.00	39.00	130.00
48° x 36° Wide-angle lens	2.2 mrad	HFOV	0.08	0.253	0.42	0.84	1.69	5.07	8.45	25.34	84.48
		VFOV	0.06	0.190	0.32	0.63	1.27	3.80	6.34	19.01	63.36
		IFOV	0.22	0.660	1.10	2.20	4.40	13.20	22.00	66.00	220.00

ADDITIONAL INFO

- The C.A 1888 thermal camera is also available in other configurations:
 - C.A 1888 with 1,000 °C high-temperature option [P01651271](#)
 - C.A 1888 with 1,500 °C high-temperature option [P01651272](#)
 - C.A 1888 Bluetooth [P01651273](#)
- RayCAM Report software supplied for area analysis (polygons or polylines) and studying the temperature distribution on a histogram

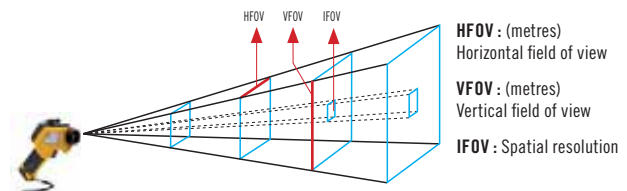

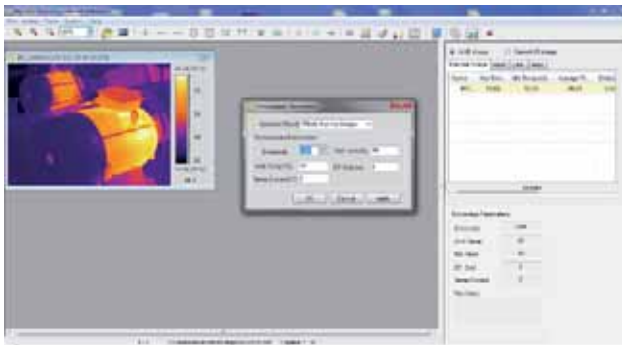

RayCam Report



STRENGTHS

- Specially developed for the C.A 1882, C.A 1886 and C.A 1888 thermal cameras
- Supplied as standard at no additional cost
- Complete, with all the functions needed for reliable analysis of the measurement results
- Creation of analysis reports exportable in Word or PDF format
- Very simple user interface

REQUIRED CONFIGURATION

WINDOWS XP :

- SP2 minimum
- 512 MB RAM minimum
- CPU 700 Hz minimum
- NET Framework 2.0 minimum
- Monitor resolution: 1,024 x 768 minimum

WINDOWS VISTA / 7 / 8 / 10 :

- SP1 minimum
- 1 GB RAM minimum
- CPU 1 GHz minimum
- NET Framework 2.0 minimum
- Monitor resolution: 1,024 x 768 minimum

AVAILABLE LANGUAGES

- French, English, German, Spanish, Italian.

PRECISE ANALYSIS TOOLS

- Cursors (automatic display of the temperature at the selected point)
- Thermal profile (automatic display of the Min/Max/Avg temperatures of the line)
- A square or circle for area analysis
- Polygons and polylines for more precise analysis of certain areas in the thermogram
- Results tables quickly and automatically display all the information
- The "Max" function automatically indicates the hot point in the whole thermogram or in a predefined area for analysis
- A histogram for studying the temperature distribution according to several intervals
- Display of a value label next to the measurement tool
- Assignment of a different emissivity from that of the rest of the thermogram
- Automatic merging of the thermal and real images recorded simultaneously
- Automatic report creation for export in .pdf or .docx format

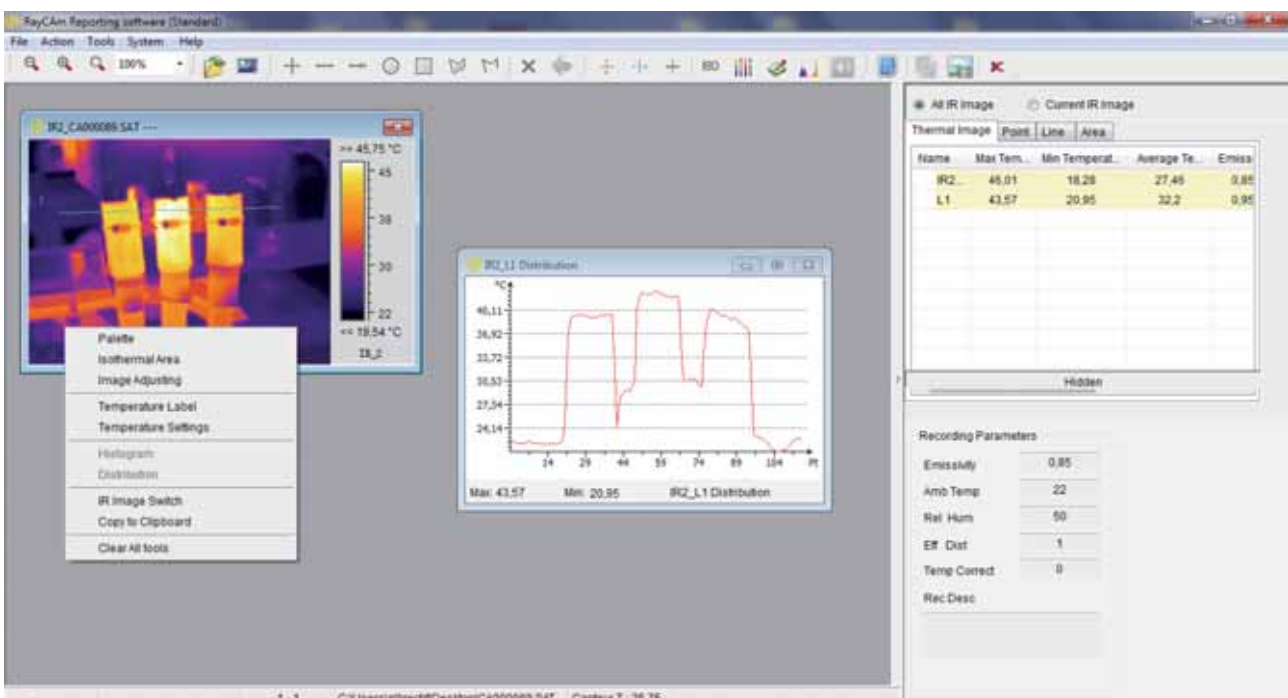



CHOOSE YOUR THERMOMETER



C.A 1871

C.A 871

C.A 879

C.A 1864

C.A 1866

C.A 876

C.A 1821

C.A 1822

C.A 1823

TK 2000

TK 2002

page 167

page 165

page 165

page 166

page 166

page 168

page 170

page 170

page 171

page 169

page 169

Measurement by infrared

	<input checked="" type="checkbox"/>	<input checked="" type="checkbox"/>	<input checked="" type="checkbox"/>	<input checked="" type="checkbox"/>	<input checked="" type="checkbox"/>	<input checked="" type="checkbox"/>					
--	-------------------------------------	-------------------------------------	-------------------------------------	-------------------------------------	-------------------------------------	-------------------------------------	--	--	--	--	--

Field of view

8/1	<input checked="" type="checkbox"/>	<input checked="" type="checkbox"/>									
10/1						<input checked="" type="checkbox"/>					
12/1			<input checked="" type="checkbox"/>								
30/1				<input checked="" type="checkbox"/>							
50/1					<input checked="" type="checkbox"/>						

Emissivity

Fixed: 0.95	<input checked="" type="checkbox"/>	<input checked="" type="checkbox"/>	<input checked="" type="checkbox"/>								
Variable: 0.1 to 1				<input checked="" type="checkbox"/>	<input checked="" type="checkbox"/>	<input checked="" type="checkbox"/>					
Laser sighting	<input checked="" type="checkbox"/>	<input checked="" type="checkbox"/>	<input checked="" type="checkbox"/>	<input checked="" type="checkbox"/>	<input checked="" type="checkbox"/>	<input checked="" type="checkbox"/>					

Contact measurement

K sensor - 1 input					<input checked="" type="checkbox"/>	J, K, T, N, E, R, S	J, K, T, N, E, R, S			K	K
K sensor - 2 inputs							J, K, T, N, E, R, S				K
Pt100 sensor									Pt100 Pt1000		

General functions

HOLD	<input checked="" type="checkbox"/>	<input checked="" type="checkbox"/>	<input checked="" type="checkbox"/>	<input checked="" type="checkbox"/>	<input checked="" type="checkbox"/>	<input checked="" type="checkbox"/>	<input checked="" type="checkbox"/>	<input checked="" type="checkbox"/>	<input checked="" type="checkbox"/>	<input checked="" type="checkbox"/>	<input checked="" type="checkbox"/>
Max				<input checked="" type="checkbox"/>	<input checked="" type="checkbox"/>	<input checked="" type="checkbox"/>	<input checked="" type="checkbox"/>	<input checked="" type="checkbox"/>	<input checked="" type="checkbox"/>		
Min				<input checked="" type="checkbox"/>	<input checked="" type="checkbox"/>	<input checked="" type="checkbox"/>	<input checked="" type="checkbox"/>	<input checked="" type="checkbox"/>	<input checked="" type="checkbox"/>		
Avg				<input checked="" type="checkbox"/>	<input checked="" type="checkbox"/>		via Data Logger Transfer	via Data Logger Transfer	via Data Logger Transfer		
Alarm				<input checked="" type="checkbox"/>	<input checked="" type="checkbox"/>	<input checked="" type="checkbox"/>	<input checked="" type="checkbox"/>	<input checked="" type="checkbox"/>	<input checked="" type="checkbox"/>		
Choice of units	<input checked="" type="checkbox"/>	<input checked="" type="checkbox"/>	<input checked="" type="checkbox"/>	<input checked="" type="checkbox"/>	<input checked="" type="checkbox"/>	<input checked="" type="checkbox"/>	<input checked="" type="checkbox"/>	<input checked="" type="checkbox"/>	<input checked="" type="checkbox"/>		
Backlighting	<input checked="" type="checkbox"/>	<input checked="" type="checkbox"/>	<input checked="" type="checkbox"/>	<input checked="" type="checkbox"/>	<input checked="" type="checkbox"/>	<input checked="" type="checkbox"/>	<input checked="" type="checkbox"/>	<input checked="" type="checkbox"/>	<input checked="" type="checkbox"/>		



C.A 871 - C.A 879

Ref. : P01651302Z

P01651805Z



STRENGTHS

- Small and easy to handle
- Simple to use
- Ideal for everyone
- Ergonomics specially designed for comfortable handling
- Laser sighting for precise targeting of measuring area

SPECIFICATIONS

	C.A 871	C.A 879
Field of view	8/1	12/1
Emissivity	Fixed: 0.95	
Measurement range	-40 °C to +538 °C	-50 °C to +550 °C
Resolution	0.1 °C up to 100 °C 1 °C for > 100 °C	
Accuracy*	±2.5% ±2 °C	±1.5% ±2 °C
Functions		
Laser sighting	Yes	
Continuous measurement	Yes (continuous press on trigger)	
Hold	Yes	
Measurement unit	°C / °F	
Display	2,000 counts, backlighting	
Dimensions / weight	160 x 82 x 41.5 mm 180 g	230 x 100 x 56 mm 290 g

*Depending on temperature measurement range. See User Manual for further details.

ACCESSORIES / REPLACEMENT PARTS

- 9 V LR14 battery _____ P01100620
- Soft case _____ P01298033

CONTENTS

- C.A 871 and C.A 879 delivered with:
 - 1 bag
 - 1 x 9 V LR14 battery



NO-CONTACT THERMOMETERS



C.A 1864 - C.A 1866

Ref. : P01651813

P01651814

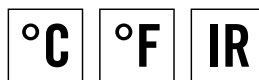

STRENGTHS

- Extended temperature range: measure up to 1,000 °C
- Use the variable emissivity to perform your inspections in accordance with reality
- High distance/spot ratio for better accuracy at long distances
- Set your alarm thresholds so that you are alerted every time there is an abnormal temperature!

SPECIFICATIONS

	C.A 1864	C.A 1866
Distance/spot ratio	30/1	50/1
Emissivity	0.1 to 1	
Measurement range	- 50 °C to +1,000 °C	
Resolution	0.1 °C	
Accuracy	- 50 °C to - 20 °C: ± 5 °C	
	- 20 °C to +200 °C: ±1.5 % R + 2 °C	
	+200 °C to +538 °C: ±2.0 % R + 2 °C	
	+538 °C to +1,000 °C: ±3.5 % R ± 5 °C	
Functions	Max., Min., Avg., DIFF, HOLD	
Alarms	High and Low	
Measurement unit	°C, °F	
Laser sighting	Yes, Class II laser	
Display	20,000 counts, backlighting	
Dimensions / weight	230 x 100 x 56 mm / 290 g	

Distance / Spot ratio: explanatory diagram

C.A 1864

D/S : 30/1
Distance (D) / Spot (S)

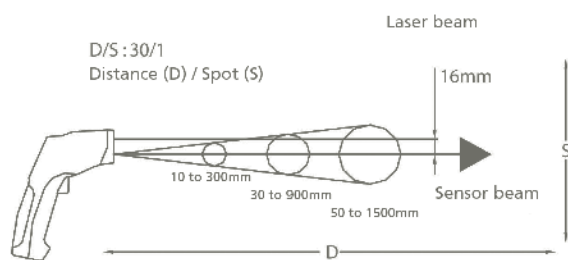

ACCESSORIES / REPLACEMENT PARTS

- 9 V LR14 battery [P01100620](#)
- Soft case [P01298033](#)

CONTENTS

- C.A 1864 and C.A 1866 delivered with:
 - 1 bag
 - 1 x 9 V LR14 battery



C.A 1871

Ref. : P01651610Z

°C IR

STRENGTHS

- Infrared probe suitable for use with all multimeters
- Point the probe at the surface of the object. The sensor supplies a voltage proportional to the temperature measured (1 mV / °C)

SPECIFICATIONS

	C.A 1871
Distance/Spot ratio	8/1
Emissivity	Fixed 0.95
Measurement range	- 30 °C to + 550 °C
Accuracy	± 2 % of reading
Dimensions / weight	164 x 50 x 40 mm / 182 g

CONTENTS

- C.A 1871 delivered with:
- 1 x 9V LR14 battery



CONTACT THERMOMETERS



C.A 876

Ref. : P01651403Z



STRENGTHS

- Rugged thanks to their shockproof protective sheath
- Temperature measurement up to 1,350 °C
- Measurement accuracy
- Stability of the sensor over time
- Infrared measurement possible with the C.A 876

SPECIFICATIONS

	C.A 876	
	IR measurement	Contact measurement
Distance/Spot ratio	10/1	-
Emissivity	0.1 to 1	-
Measurement range	- 20 °C to + 550 °C	- 40 °C to + 1350 °C
Accuracy	± 2 % R or ± 3 °C	± 0.1 % R +1 °C
Functions	Max., Min., Avg., HOLD, Alarms	
Dimensions / weight	173 x 60.5 x 38 mm / 255 g	

CONTENTS

- 1 shockproof sheath
- 1 flexible K-thermocouple sensor

ACCESSORIES / REPLACEMENT PARTS

- K thermocouples page 180
- CK extensions page 180



TK 2000 - TK 2002

Ref.: P01653100

P01653110



STRENGTHS

- Compact, accurate and simple to use: connect the sensor and start measuring!
- Usable in all environments thanks to their IP 65 protection
- Measures the temperature difference by means of the 2 thermocouple inputs on the TK 2002

SPECIFICATIONS

	TK 2000	TK 2002
No. of inputs	1	2
Range	- 50 °C to +1,000 °C	
Accuracy	± 1.5 % + 0.5 °C	
Functions	HOLD, °C	
Dimensions	163 x 63 x 37.5 mm	
Weight	200 g	

CONTENTS

- 1 battery
- **TK 2000** delivered with:
 - 1 flexible K-thermocouple sensor
 - 1 x 9 V 6LR61 battery
- **TK 2002** delivered with:
 - 2 flexible K-thermocouple sensors
 - 1 x 9 V 6LR61 battery

ACCESSORIES / REPLACEMENT PARTS

- K-thermocouples [page 180](#)
- CK extensions [page 180](#)



CONTACT THERMOMETERS



C.A 1821 - C.A 1822

Ref. : P01654821

P01654822

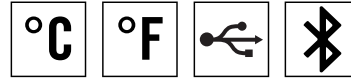

STRENGTHS

- J, K, T, N, E, R, S thermocouples
- Recording of up to 1 million points
- Magnetized product compatible with MultiFix
- USB and Bluetooth communication
- Backlit digital display

SPECIFICATIONS

	C.A 1821	C.A 1822
Sensor	Thermocouple J, K, T, N, E, R, S	
No. of inputs	1	2
Measurement range	J: 210 to +1,200 °C / 346 to +2,192 °F K: 200 to +1,372 °C / 328 to +2,501 °F T: 250 to +400 °C / 418 to +752 °F N: 200 to +1,300 °C / 328 to +2,372 °F E: 150 to +950 °C / 238 to +1,742 °F R 0 to +1,767 °C / 32 to +3,212 °F S 0 to +1,767 °C / 32 to +3,212 °F	
Resolution	Display in °C: $\varnothing < 1,000$ °C: 0.1 °C and $\varnothing \geq 1,000$ °C: 1 °C Display in °F: $\varnothing < 1,000$ °F: 0.1 °F and $\varnothing \geq 1,000$ °F: 1 °F	
Accuracy	(J, K, T, N, E) $\varnothing \leq -100$ °C $\pm (0.2\% \text{ Reading} + 0.6$ °C) -100 °C $< \varnothing \leq +100$ °C $\pm (0.15\% R + 0.6$ °C) $+100$ °C $< \varnothing \pm (0.1\% R + 0.6$ °C) (R, S) $\varnothing \leq +100$ °C $\pm (0.15\% R + 1.0$ °C) $+100$ °C $< \varnothing \pm (0.1\% R + 1.0$ °C)	
Functions	Min., Max., HOLD, alarms, temperature differential (C.A 1822)	
Recording	Manual Start / Stop on the product Programmed recording	
Alarms	Visual alert on threshold overrun set via Data Logger Transfer Recording can be triggered on alarm threshold	
Data storage	More than one million points	
Power supply	3 x 1.5V LR6 alkaline batteries or NiMH rechargeable battery Mains connection possible with the mains / micro USB adapter (option)	
Battery life	1,000 hrs (portable mode) 3 years for recording (15-minute measurement interval)	
Dimensions/weight	150 x 72 x 32 mm / 260 g with batteries	
Ingress protection	IP54 casing	
Operating temperature/humidity	-10 to +60 °C / 10 to 90 % RH	
Standards	IEC61010-1 / IEC 61326-1	

ADDITIONAL INFO

- Shockproof sheath available as an accessory
- Compatible with the Data Logger Transfer module of the Dataview® software for:
 - data display
 - programming of recordings
 - automatic export of the report

CONTENTS

C.A 1821 and C.A 1822 delivered with:

- 1 bag
- 3 x 1.5 V LR6 batteries
- 1 USB cable
- 1 measurement report

ACCESSORIES / REPLACEMENT PARTS

- Thermocouple _____ Page 188
- Shockproof sheath + MultiFix accessory _____ P01654252
- CK extensions _____ page 188
- See all the accessories on page 188



C.A 1823

Ref. : P01654823

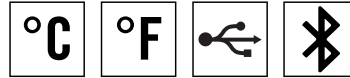

STRENGTHS

- Pt100 or Pt1000 resistance probe
- Recording of up to 1 million points
- MultiFix-compatible magnetized product
- USB and Bluetooth communication
- Backlit digital display

SPECIFICATIONS

	C.A 1823
Sensor	Pt100 or Pt1000 probe
No. of inputs	1
Measurement range	- 100 to + 400°C -148 to + 752°F
Resolution	Display in °C: 0.1 °C Display in °F: 0.1 °F
Accuracy	± (0.4% R + 0.3°C)
Functions	Min., Max., HOLD, alarms
Recording	Manual Start / Stop on the product Programmed recording
Alarms	Visual alert on threshold overrun set via Data Logger Transfer Recording can be triggered on alarm threshold
Data storage	More than one million points
Power supply	3 x 1.5V LR6 alkaline batteries or NiMH rechargeable battery Mains connection possible with the mains / micro USB adapter (option)
Battery life	800 hrs (portable mode) 3 years for recording (15-minute measurement interval)
Dimensions / weight	150 x 72 x 32 mm / 260 g with batteries
Ingress protection	IP54 casing
Operating temperature/ humidity	-10 to +60 °C / 10 to 90 % RH
Standards	IEC61010-1 for 50 V voltages in category II / IEC 61326-1

ADDITIONAL INFO

- Shockproof sheath available as an accessory
- Compatible with the Data Logger Transfer module of the Dataview® software for:
 - data display
 - programming of recordings
 - automatic export of the report

CONTENTS

C.A 1823 delivered with:

- 1 bag
- 3 x 1.5 V LR6 batteries
- 1 USB cable
- 1 measurement report

ACCESSORIES / REPLACEMENT PARTS

- Thermocouple assembly _____ Page 188
- Shockproof sheath + MultiFix accessory _____ P01654252
- CK extensions _____ page 188
- See all the accessories on page 188



CHOOSE YOUR INSTRUMENT FOR PHYSICAL MEASUREMENTS



C.A 847

page 175



C.A 1246

page 174



C.A 1227

page 176



C.A 850

page 178



C.A 852

page 178



C.A 895

page 185



C.A 1510

page 184



C.A 1052

page 177

Temperature measurement								
CMOS		■					■	
Pt 100 sensor								■
CTN			■					
2-input K sensor								■
Relative humidity measurement								
RH air		■					■	■
Dew point measurement		■						■
RH material	■							
Air-speed measurement								
Rotating-vane sensor			■					■
Hot-wire sensor								■
Flow-rate measurement			■					■
Air-pressure measurement								
Differential pressure				■	■			■
High pressure (=> 10 bars)				■				
Low pressure (=> 100 mbar)					■			■
Gas measurement								
CO gas measurement						■		
CO ₂ gas measurement							■	
General functions								
HOLD		■	■	■	■	■	■	■
Max		■	■	■	■	■	■	■
Min		■	■	■	■		■	■
Avg		Via Data Logger Transfer	■					■
Choice of units		■	■	■	■		■	■
Backlighting		■	■	■	■	■	■	■
Alarm		■				■	■	
Recording		■	■				■	■
Software		■	■				■	■



CHOOSE YOUR INSTRUMENT FOR PHYSICAL MEASUREMENTS



C.A 1110

page 179



C.A 832

page 180



C.A 834

page 181



C.A 1725

page 182



C.A 1727

page 182

	C.A 1110	C.A 832	C.A 834	C.A 1725	C.A 1727
Lighting measurement					
< 200,000 lux	■				
Spectral correction	■				
Incidence correction	■				
Noise measurement					
A and C frequency weighting		■	■		
Slow/fast time weighting		■	■		
Analogue output		■	■		
Speed measurement					
With and without contact				■	■
Rotation speed				■	■
Linear speed				■	■
Frequency, period				■	■
Duty cycle				■	■
Metering					■
General functions					
HOLD	■		■	■	■
Max	■	■	■	■	■
Min	■		■	■	■
Avg	■				
Choice of units	■			■	■
Backlighting	■	■	■		
Alarm					■
Recording	■		■		■
Software	■		■		■



ADDITIONAL INFO

- Compatible with the Data Logger Transfer module of the Dataview® software for:
 - data display
 - programming of recordings
 - automatic export of the report

C.A 1246

Ref. : P01654246



STRENGTHS

- Hygrometry, temperature and dew point
- Recording up to 1 million points
- Visual alarm on threshold overrun
- MultiFix-compatible magnetized product
- Recording trigger on alarm threshold

SPECIFICATIONS

	C.A 1246
RH range	3.0 to 98.0 %RH
RH accuracy	10 to 90 %RH: $\pm (2 \%RH \pm 1 \text{ ct})$, outside that range: $\pm (4 \%RH \pm 1 \text{ ct})$
Temp. range °C/°F	- 10.0 to + 60.0°C +14.0 to + 140.0°F
Temp. accuracy °C/°F	10 to 40°C: $\pm (0.5°C \pm 1 \text{ ct})$ outside that range: $\pm (0.032 \times (T-25) \pm 1 \text{ ct}) / T=$ temperature in °C
Dew point range	- 20.0 to + 60.0°Ctd -4.0 to + 140.0 °Ftd
Dew point accuracy	1.5 °C from 20 % RH to 30 % RH 1 °C above 30 % RH
Functions	Min., Max., HOLD, alarms
Recording	Manual Start / Stop on the product Programmed recording
Alarms	Visual alert on threshold overrun set via Data Logger Transfer Recording can be triggered on alarm threshold
Data storage	More than 1 million points
Power supply	3 x 1.5V AA / LR6 alkaline batteries or NiMH rechargeable battery Mains connection possible with the mains / micro USB adapter (option)
Battery life	1,000 hrs (portable mode) 3 years for recording (15-minute measurement interval)
Dimensions/weight	187 x 72 x 32 mm / 260 g with batteries
Ingress protection	IP54 casing
Operating temperature/humidity	-10 to +60 °C / 10 to 90 % RH
Standards	IEC61010-1 / IEC 61326-1

CONTENTS

- C.A 1246 delivered with:
 - 1 bag
 - 3 x 1.5 V LR6 batteries
 - 1 USB cable
 - 1 measurement report

ACCESSORIES / REPLACEMENT PARTS

- 75 % salt cartridge P01156401
- 33 % salt cartridge P01156402
- See all the accessories on page 188



C.A 847

Ref. : P01156302Z

STRENGTHS

- Measure the humidity of your materials very simply: prick the material and note the value corresponding to the LED which lights up.

SPECIFICATIONS

	C.A 847
RH range	6 to 100% RH
Accuracy RH	± 1 LED
Dimensions	173 x 60.5 x 38 mm
Weight	160 g

CONTENTS

- The C.A 847 is delivered with one 9 V 6LR61 battery



C.A 1227

Ref. : P01654227



STRENGTHS

- Temperature, air speed and air flow rate
- Mapping of measured air speeds (MAP mode)
- Min, Max, Average and Hold functions
- Recording up to 1 million points

SPECIFICATIONS

	C.A 1227
Air speed / flow rate sensor	Rotating vane with optical detection
Air speed range	0.25 m/s to 35.0 m/s (49.0 to 6890.0 fpm)
Air speed accuracy	± 3 % of reading ± 4 counts
Air flow rate range	0 to 2,999 m ³ /h
Air flow rate accuracy	± 8% of reading
Temp. range °C/°F	- 20.0 to + 50.0 °C / - 4 to + 122 °F
Temp. accuracy °C	0 to 50 °C: ± 0.8 °C / -20 to 0 °C: ± 1.6 °C
Functions	Min., Max., HOLD, Average
Recording	Manual Start / Stop on the product
Data storage	Programmed recording
Power supply	3 x 1.5V LR6 alkaline batteries Mains connection possible with the mains / micro-USB adapter offered as an accessory
Battery life	200 hrs (portable mode) / 8 days of recording (15-minute intervals)
Dimensions	Casing: 150 x 72 x 32 mm Sensor: 160 x 80 x 38 mm Spiral cable: 24 to 120 cm
Weight	Approx. 400 g
Ingress protection	IP40 casing
Operating temperature / humidity	-10 to +60 °C / 10 to 90 % RH
Standards	IEC 61010-1 - IEC 61326-1

ADDITIONAL INFO

- Compatible with the Data Logger Transfer module of the Dataview® software for:
 - data display
 - programming of recordings
 - automatic export of the report

ACCESSORIES / REPLACEMENT PARTS

- Cones kit for flow-rate measurement with rotating vane (circular cross-section Ø 210mm and rectangular cross-section 346x346mm) P01654250
- Vane sensor Ø80mm P01654251
- See all the accessories on page 188

CONTENTS

- C.A 1227 delivered with:
 - 1 bag
 - 3 x 1.5 V LR6 batteries
 - 1 USB cable
 - 1 measurement report



Physics-Log software

- Choice of campaigns to be downloaded
- Linking of operator and customer to the campaigns
- C.A 1052 memory dump
- Display of the curves corresponding to the downloaded data
- Customization of the graphs
- Backup in pdf format for distribution to customer



C.A 1052

Ref. : P01175020

STRENGTHS

- Can be used for comprehensive surveys of air-conditioning, heating and ventilation systems
- Accurate, 5-in-1 instrument: measurement of air speed, relative humidity, flow-rate, pressure and temperature
- Complete: the instrument is delivered as standard with its probes in a case
- Particularly easy to use: connect the probe (recognized automatically) and measure!
- Data backup

SPECIFICATIONS

	C.A 1052	
	Measurement range	Accuracy
Hot-wire speed	0.15 to 3 m/s	± 3 % R + 0.03 m/s
	3.1 to 35 m/s	± 3 % R + 0.1 m/s
∅ 100 mm rotating-vane speed	0.25 to 3 m/s	± 3 % R + 0.1 m/s
	3.1 to 35 m/s	± 1 % R + 0.3 m/s
Environmental temperature	-20 °C to +80 °C	± 0.4 % R + 0.3 °C
Flow-rate	0 to 99,999 m ³ /h	3 % R
Relative humidity	3 to 98 % RH	± 1 % R + 1.5 % RH
Dew point	-50 °C to +70 °C	± 0.8 % R + 0.6 °C
Pressure	0 to 1,000 mm H ₂ O	± 0.2 % R + 1
Temperature (2 K-thermocouple inputs)	-200 °C to +1,300 °C	±0.4 % R or 1.1 °C
	-100 °C to +750 °C	±0.4 % R or 0.8 °C
	-200 °C to +400 °C	±0.4 % R or 0.5 °C
Function	HOLD, Min., Max., Avg.	
Recording	8,000 counts	
Dimensions	161.9 x 80.8 x 57.4 mm	
Weight	380 g	

CONTENTS

- C.A 1052 delivered with:
 - 1 case with all its probes
 - 4 x 1.5 V LR06 batteries
 - PhysicsLog software

ACCESSORIES / REPLACEMENT PARTS

- Straight extension P01102010
- Elbowed extension P01102011
- See all the accessories on page 188



C.A 850 - C.A 852

Ref.: P01184101

P01184102

STRENGTHS

- Accurate and simple to use
- Time/date-stamped monitoring
- Differential measurements

SPECIFICATIONS

	C.A 850	C.A 852
Measurement range	-6.89 to +6.89 bar	-138 to +138 mbar
Accuracy	0.3 % full scale	
Unit	psi, bar, mbar, mmH ₂ O, inH ₂ O	
	kbar, cmH ₂ O, FtH ₂ O, mmHg, OZin ² , kg/cm ²	-
Functions	Differential meas., Min., Max., HOLD	
Dimensions	182 x 72 x 30 mm	
Weight	220 g	

CONTENTS

- C.A 850 delivered with:
 - 1 hard case
 - 2 connection tubes
 - 1 x 9 V 6LR61 battery
- C.A 852 delivered with:
 - 1 hard case
 - 2 connection tubes
 - 1 x 9 V 6LR61 battery



C.A 1110

Ref. : P01654110



STRENGTHS

- Totally compliant lighting measurement in all directions
- Measures up to 200,000 lux
- Mapping of lighting measured for an area or room (MAP mode)
- Metrological compensation on Fluo LEDs.
- Min., Max., Avg. and HOLD
- Recording up to 1 million points

SPECIFICATIONS

	C.A 1110
Measurement range	0.1 lx to 200,000 lx (lux) 0.01 fc to 18,580 fc
Accuracy in standard mode	
Incandescent lamp	± 3% of reading
LED	± 6% of reading (3,000 K to 6,000 K)
Fluorescent lamp	± 9% of reading
Accuracy in compensation mode	
LED mode	± 4% of reading (at 4,000 K)
Fluo mode	± 4% of reading (type F11, 4,000 K)
Functions	Min., Max., HOLD, Average
Recording	Manual Start / Stop on the product Programmed recording
MAP mode	The MAP function can be used to map the lighting on a surface or in a room. In this way, the lighting measurements are saved in the same file.
Data storage	More than 1 million points
Power supply	3 x 1.5V AA / LR6 alkaline batteries or NiMH rechargeable battery Mains connection possible with the mains / micro USB adapter (option)
Battery life	500 hrs (portable mode) / 3 years of recording (15-minute measurement interval)
Dimensions	Casing: 150 x 72 x 32 mm Sensor: 67 x 64 x 35 mm (with protective cover) Spiral cable: 24 to 120 cm
Weight	345 g with batteries
Ingress protection	IP50 casing
Operating temperature / humidity	-10 to +60 ° C / 10 to 90 % RH
Standards	Class C as per the French NF C 42-710 standard based on the CIE guidelines

ADDITIONAL INFO

- Compatible with the Data Logger Transfer module of the Dataview® software for:
 - data display
 - programming of recordings
 - automatic export of the report

ACCESSORIES / REPLACEMENT PARTS

- Shockproof sheath + MultiFix accessory P01654252
- Mains adapter P01651023
- See all the accessories on page 188

CONTENTS

- C.A 1110 delivered with:
 - 1 bag
 - 3 x 1.5 V LR6 batteries
 - 1 USB cable
 - 1 measurement report



C.A 832

Ref. : P01185501Z

dBA

dBc

STRENGTHS

- Sound-level testing
- Simple to use

SPECIFICATIONS

	C.A 832
Measurement range	37 to 130 dB
Calibres	3 calibres: 37 to 80 dB 50 to 100 dB 80 to 130 dB
Accuracy	±2 dB
Frequency range	31.5 Hz to 8,000 Hz
Functions	A and C frequency weighting curves Fast and slow time weighting -
Analogue output	10 mV/dB or 1 V _{RMS}
Data storage	-
Software	-
Dimensions	237 x 60.5 x 38 mm
Weight	230 g

CONTENTS

- C.A 832 delivered with:
 - 1 shockproof sheath
 - 1 jack socket for analogue output
 - 1 universal adapter for tripod mounting
 - 1 x 9 V 6LR61 battery

ACCESSORIES / REPLACEMENT PARTS

- 94 dB or 114 dB sound-level meter calibrator, C.A 833 _____ P01185301
- See all the accessories on page 188



C.A 834

Ref. : P01185502

dB_A **dB_C**

STRENGTHS

- Monitoring of noise-exposure levels: recording of up to 32,000 values!
- Process the data on PC with the software supplied as standard

SPECIFICATIONS

	C.A 834
Measurement range	30 to 130 dB
Calibres	4 calibres: 30 to 80 dB 50 to 100 dB 80 to 130 dB Auto 30 to 130 dB
Accuracy	±1.5 dB
Frequency range	31.5 Hz to 8,000 Hz
Functions	A and C frequency weighting curves Fast and slow time weighting Min., Max, HOLD
Analogue output	10 mV/dB or 1 V _{RMS}
Data storage	32,000 values
Software	Yes
Dimensions	275 x 64 x 30 mm
Weight	285 g

CONTENTS

- C.A 834 delivered with:
 - 1 hard case with data processing software
 - 1 jack/USB cable
 - 1 jack socket for analogue output
 - 1 x 9 V 6LR61 battery

ACCESSORIES / REPLACEMENT PARTS

- 94 dB or 114 dB sound-level meter calibrator, C.A 833 _____ P01185301
- Microphone extension for C.A 834 _____ P01102085
- See all the accessories on page 188



TACHOMETERS



C.A 1725 - C.A 1727

Ref. : P01174810

P01174830

STRENGTHS

- Measurements up to 100,000 RPM
- Measurement with and without contact
- Multiple functions available: rotation speed, linear speed, counting, frequency, period
- Possibility of programming and storage capacity
- C.A 1727
- USB connection to process the recordings on PC

SPECIFICATIONS

	C.A 1725	C.A 1727
RPM functions		
Range	60 to 100,000 RPM	
Accuracy	10 ⁻⁴ R ± 6 cts	
m/min function		
Range	60 to 10,000 m/min.	
Accuracy	10 ⁻⁴ R ± 1 increment	
Hz function		
Range	1 to 10,000 Hz	
Accuracy	4 x 10 ⁻⁵ R ± 4 cts	
ms function		
Range	0.1 to 1,000 ms	
Accuracy	10 ⁻⁴ R ± 5 cts	
Report function		
Range	0.1 to 100%	
Accuracy	0.1% to 1%	
Counting function		
Range	-	0 to 100,000 events
Accuracy	-	± 1 events
Functions	Min., Max., HOLD, Smooth	
	-	High and low alarms
Data storage	4,000 counts	
Dimensions	21 x 72 x 47 mm	
Weight	250 g	

CONTENTS

- C.A 1725 delivered with:
 - 1 hard case
 - 1 FRB F connector
 - 1 x 9 V LR14 battery
 - 1 set of 15 strips of reflective tape (0.1 m long)
 - 1 CD-ROM containing the user manual
- C.A 1727 delivered with:
 - 1 hard case
 - 1 FRB F connector
 - 1 x 9 V LR14 battery
 - 1 set of 15 strips of reflective tape (0.1 m long)
 - 1 CD-ROM containing the TACHOGRAPH software

ACCESSORIES / REPLACEMENT PARTS

- Mechanical accessories kit [P01174902](#)
- End-fittings (set of 3) [P01174903](#)
- See all the accessories on page 188



STROBOSCOPE

CDA 9452

Ref. : P03197704

Flashes
/min

STRENGTHS

- Frequency or speed measurement without contact with rotating parts
- Digital frequency display
- Quartz time base
- White flash lamp, 40 joules

SPECIFICATIONS

	CDA 9452
LED display	10,000 points
Measurement range	100... 1,000 flashes/min 1000... 10,000 flashes/min
Resolution	1 flash/min
Accuracy	0.05 %
Power supply	220 V – 50/60 Hz
Climatic conditions	0... + 50 °C / RH < 80 %
Dimensions	210 x 120 x 120 mm
Weight	1 kg

ADDITIONAL INFO

- When the flashes from the stroboscope are directed at an object moving periodically and have the same frequency as the phenomenon observed, the object appears immobile. All you then need to do is read the frequency expressed in flashes/minute on the CDA 9452. To obtain the frequency in Hz, simply divide the reading by 60.

CONTENTS

- CDA 9452 delivered with mains power cable

CO₂, TEMPERATURE & HUMIDITY LOGGER

C.A 1510

Ref. : P01651011



SPECIFICATIONS

C.A 1510	
Specifications for CO₂	
Measurement range	0 to 5,000 ppm
Accuracy	± 50 ppm ± 3% of measured value
Resolution	1 ppm
Temperature measurement	
Measurement range	-10 °C to +60 °C
Accuracy	± 0.5 °C
Resolution	0.1 °C
Humidity measurement	
Measurement range	5 to 95 % RH
Accuracy	± 2% RH
Resolution	0.1% RH
Product capabilities	
Portable measurement	Quick measurement and display of the CO ₂ , temperature and relative humidity values
Indicator	<p>Mode 1D : CO₂ confinement indication Visual indication (two-colour backlighting and pictograms) and/or audible indication of high confinement when the CO₂ concentration is between 1,000 ppm and a 1,700 ppm threshold.</p> <p>3D mode: indication of optimum comfort zone on the basis of hygrothermal criteria and the CO₂ concentration</p>
Energy saving (ECO)	For fixed use on battery power, the product performs measurements every 10 minutes over a programmable time range for a battery life of up to one year
Logger	<p>Activation of programmed recording (P_REC) The start date, recording rate and end date can be customized with the PC software or the Android application. Possibility of locking the display in this mode (no values displayed).</p> <p>Manual activation (M_REC) Manual start and stop controls on the product. Recording is performed at the rate of the mode currently selected.</p>
Specifications	
Recording rate	Customizable from 1 minute to 2 hours
Data storage	More than 1 million points
Buzzer and units	Yes / °C or °F
Backlighting / Hold / Min Max	Yes
Dimensions / weight	125 x 65.5 x 32 mm / 190 g with batteries
Power supply	Batteries: 2 x 1.5 V AA / LR6 or rechargeable battery Connection to mains possible with mains / micro USB adapter supplied as standard
Interfaces	2 communication modes possible: Bluetooth wireless communication and USB link; the product is then recognized as a USB key for easy file transfer
Mounting	C.A 1510 casing equipped with a magnet, a wall-suspension system and a slit for hanging the product. A wall support for use with a padlock (padlock not supplied) is available as an accessory, as is a desktop stand (supplied as standard with the C.A 1510W).
AQR (Air Quality Report) software supplied as standard	Graphic representation or as table of values - Data export - Real-time mode Calculation of the confinement index with selection of presence periods – Report generation

STRENGTHS

- CO₂, temperature and humidity logger (up to 1 million points)
- Compact: for fixed or portable use
- User-friendly: thanks to the comfort-level indicators based on the level of CO₂ and hygrothermal criteria
- Accurate: complies with the latest regulations on air-quality monitoring
- Low gas consumption thanks to its in-situ calibration kit

ADDITIONAL INFO

- C.A 1510 also available in black P01651010
- Delivered in a metal case

CONTENTS

- Delivered in cardboard box with:
 - 2 x 1.5 V LR06 batteries
 - 1 USB mains adapter
 - 1 USB-micro USB cable
 - 1 desk stand
 - AQR software
 - 1 user manual (5 languages) on CD-ROM
 - 1 verification certificate

ACCESSORIES / REPLACEMENT PARTS

- In-situ calibration kit P01651022
- Metal case P01298071
- See all the accessories on page 188



C.A 895

Ref. : P01651001Z

PPm
CO

STRENGTHS

- Measures the level of carbon monoxide present in a room
- Checks the operation of combustion equipment
- Warning buzzer to indicate when there is a risk

SPECIFICATIONS

	C.A 895
Measurement range	0 to 1,000 ppm
Accuracy	± 5 % + 5 ppm
Measurement mode	Normal or Avg.
Functions	Alarm, Max., HOLD
Dimensions	237 x 60.5 x 38 mm
Weight	190 g

CONTENTS

- C.A 895 delivered with:
- 1 shockproof protective sheath
- 1 x 9 V LR14 battery

ACCESSORIES / REPLACEMENT PARTS

- Aspiration kit with pump and extension P01651101



DATAVIEW®

Ref. : P01102095

Data Logger Transfer

FUNCTIONS

- Configuration of all the functions of instruments connected to a PC or via Bluetooth
- Display of the data in table and graph form
- Export to an Excel spreadsheet or jpeg image
- Programming of recordings (date and rate)
- Automatic export of reports in Word format

ADDITIONAL INFO

- Totally configurable alarms and recordings on alarms
- The **Dataview®** software automatically recognizes the instrument connected when it is hooked up to the PC and launches the corresponding menu. Users then have direct access to its configuration and to the stored data.

REQUIRED CONFIGURATION

- Windows Vista & Windows 7/8/10 (32/64 bit)
- 1 GB RAM for Windows Vista & Windows 7/8 (32 bit)
- 2 GB RAM for Windows Vista & Windows 7/8 (64 bit)
- 80 MB available space on hard disk (200 MB recommended)

DataView® modules	Data Logger Transfer
Related products	C.A 1821
	C.A 1822
	C.A 1823
	C.A 1246
	C.A 1227
	C.A 1110

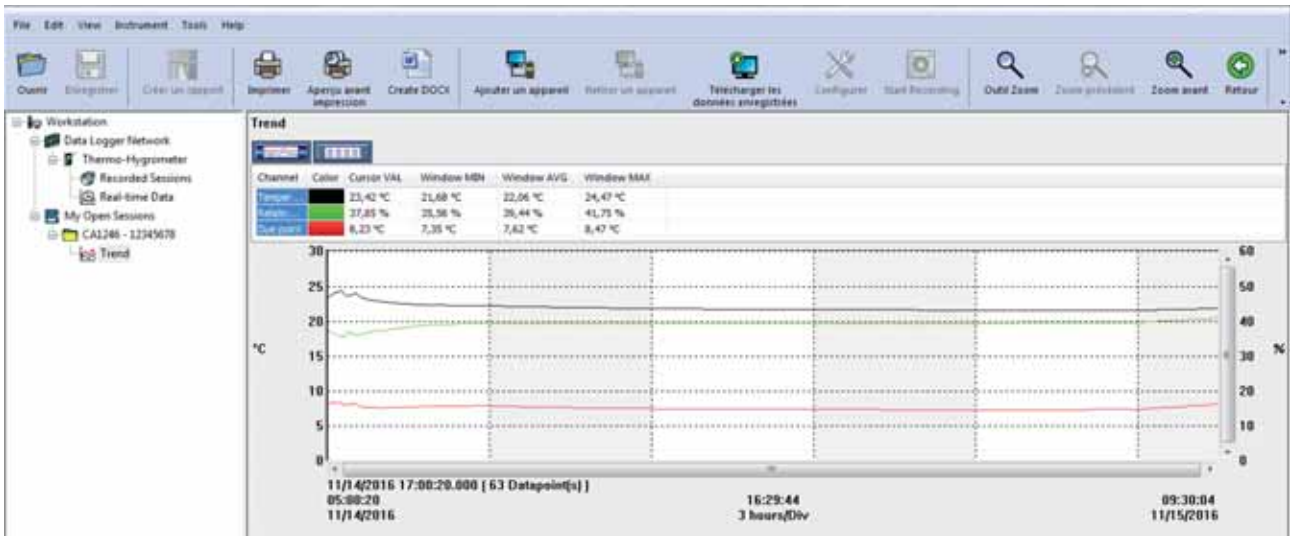

General Recording Thermo-Hygrometer Alarms

Session name: []

Session type
 Record new
 Schedule recording
 Alarm triggered recording

Start date: 26/11/2016 Start time: 10:22:00
 End date: 26/11/2016 End time: 10:37:00

Storage duration: 000 : 00 : 15 : 00 D : H : M : S [Reset date/time]

Sampling period
 Demand period: 1 s

Estimated battery autonomy
 Not recording: Not
 When recording: Not
 The battery autonomy is only indicative. It takes into account the voltage level of batteries, which is dependent of temperature and battery quality. The indication assumes that your batteries were fully charged when replaced.

Disk space
 33,23% of the memory has been used.
 7,15 Mbytes of available memory, 7,96 Mbytes total memory capacity.
 0,08% of the memory is needed by the current recording settings.
 You should modify the settings of your recording or make space in the memory.

Keyboard locked during recording
 Select this option to disable any keyboard action during recording. Once the recording starts with this option, keyboard is locked until the end of recording (end of session reached or with the "Stop recording" command of PhysICA Control Panel).

[Read] [Save] [Load]

Data Logger Transfer - C:\Users\arnoux\Documents\PhysICA\Control Data Logger\201611\Sec000\Recording

Date	Time	Temperature	Relative Humidity	Use point
14/11/2016	17:46:06	23,22 °C	36,00 %	3,77 °C
14/11/2016	17:46:07	23,22 °C	36,00 %	3,77 °C
14/11/2016	17:46:08	23,22 °C	36,00 %	3,77 °C
14/11/2016	17:46:09	23,21 °C	36,00 %	3,76 °C
14/11/2016	17:46:10	23,21 °C	36,00 %	3,76 °C
14/11/2016	17:46:11	23,21 °C	36,00 %	3,76 °C
14/11/2016	17:46:12	23,21 °C	36,00 %	3,76 °C
14/11/2016	17:46:13	23,21 °C	36,00 %	3,76 °C
14/11/2016	17:46:14	23,21 °C	36,00 %	3,76 °C
14/11/2016	17:46:15	23,21 °C	36,00 %	3,76 °C
14/11/2016	17:46:16	23,21 °C	36,00 %	3,76 °C
14/11/2016	17:46:17	23,21 °C	36,00 %	3,76 °C
14/11/2016	17:46:18	23,21 °C	36,00 %	3,76 °C
14/11/2016	17:46:19	23,21 °C	36,00 %	3,76 °C
14/11/2016	17:46:20	23,21 °C	36,00 %	3,76 °C
14/11/2016	17:46:21	23,21 °C	36,00 %	3,76 °C
14/11/2016	17:46:22	23,21 °C	36,00 %	3,76 °C
14/11/2016	17:46:23	23,21 °C	36,00 %	3,76 °C
14/11/2016	17:46:24	23,21 °C	36,00 %	3,76 °C
14/11/2016	17:46:25	23,21 °C	36,00 %	3,76 °C
14/11/2016	17:46:26	23,21 °C	36,00 %	3,76 °C
14/11/2016	17:46:27	23,21 °C	36,00 %	3,76 °C
14/11/2016	17:46:28	23,21 °C	36,01 %	3,77 °C
14/11/2016	17:46:29	23,21 °C	36,01 %	3,77 °C
14/11/2016	17:46:30	23,21 °C	36,01 %	3,77 °C
14/11/2016	17:46:31	23,21 °C	36,01 %	3,77 °C
14/11/2016	17:46:32	23,21 °C	36,01 %	3,77 °C
14/11/2016	17:46:33	23,22 °C	36,01 %	3,78 °C



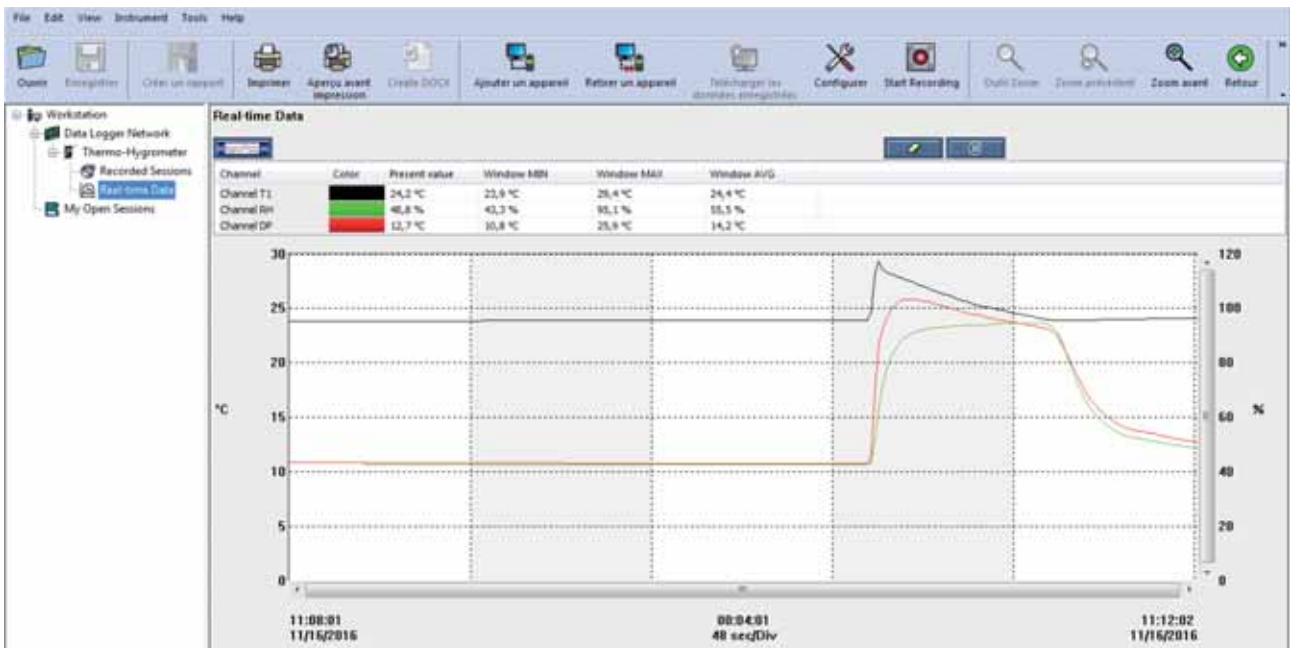











PhysICA, version 11

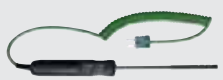

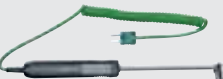

THERMOMETERS

K-THERMOCOUPLE SENSORS

Model	Model	Description
	SK20	Sheathed sensor as per the NF EN 61615 standard. Hot junction isolated from chassis-earth. Inconel 600 protective sheath
	SK6	“General-purpose” sensor recommended for measurements where access is difficult. Do not use in liquids (tip is not leakproof)
	SK2	Sensor with stainless-steel sheath which can be bent as required Radius of curvature > 4 mm
	SK3	Slightly bendable sensor with stainless-steel sheath
	SK13	Sensor with stainless-steel sheath
	SK7	In “calm” conditions without air movement, shake the sensor to encourage heat exchange
	SK17	In “calm” conditions without air movement, shake the sensor to encourage heat exchange
	SK1	Sensor with stainless-steel sheath for penetration (20 mm min.) in pasty, viscous or liquid specimens
	SK11	Sensor with stainless-steel sheath for penetration (20 mm min.) in pasty, viscous or liquid specimens
	SK4	Sheathed sensor with stainless-steel sensing element and Teflon base. For small flat surfaces. Contact can be improved by using silicone grease.
	SK14	For surface temperatures when access is difficult
	SK5	For flat surfaces. The spring ensures optimum contact even if the sensor is not positioned perpendicularly. Contact can be improved by using silicone grease.
	SK15	For flat surfaces. The spring ensures optimum contact even if the sensor is not positioned perpendicularly. Contact can be improved by using silicone grease.
	SK8	For measurements on pipes. The copper sheet is applied to the clean, dry pipe. The two-sided Velcro strip ensures contact by winding.
	SK19	Sensor with magnet for flat metal surfaces

Class I accuracy / -40 °C to +375 °C: ± 1.5°C / +375 °C to +1,000°C: ± 0.004 x T °C.
 Class II accuracy / -40 °C to +333 °C: ± 2.5°C / +333 °C to +1,200°C : ± 0.0075 x T °C.



Type / Application	Measurement range	Tolerance class	63% response time	Plunger diameter	Plunger length	Ref.	Model
Flexible general-purpose sensor	-50°C to 450°C	Cl. 1	1 s	1.5 mm	1 m	P01655010	SK20
Flexible sensor	-50°C to 285°C	Cl. 2	1 s contact	1 mm	1 m	P03652906	SK6
Bendable general-purpose sensor	-50°C to 1,000°C	Cl. 2	3 s ambient	2 mm	1 m	P03652902	SK2
Semi-rigid general-purpose sensor	-50°C to 1,000°C	Cl. 2	2 s	4 mm	50 cm	P03652903	SK3
General-purpose sensor	-50°C to 1,100°C	Cl. 2	6 s	3 mm	30 cm	P03652918	SK13
Air sensor for ambient measurements	-50°C to 250°C	Cl. 2	12 s	5 mm	15 cm	P03652907	SK7
Air sensor for ambient measurements	-50°C to 600°C	Cl. 2	5 s	6 mm	13 cm	P03652921	SK17
Needle sensor for penetration	-50°C to 800°C	Cl. 2	1 s	3 mm	15 cm	P03652901	SK1
Needle sensor for penetration	50°C to 600°C	Cl. 2	12 s	3 mm	13 cm	P03652917	SK11
Surface sensor	0°C to 250°C	Cl. 2	1 s	5 mm	15 cm	P03652904	SK4
Elbowed surface sensor	-50°C to 450°C	Cl. 2	8 s	6 mm	13 cm	P03652919	SK14
Surface sensor with spring	-50°C to 500°C	Cl. 2	1 s	5 mm Ø in contact 8.5 mm	15 cm	P03652905	SK5
Surface sensor with spring	-50°C to 900°C	Cl. 2	2 s	8 mm	13 cm	P03652920	SK15
Pipe sensor	-50°C to 140°C	Cl. 2	10 seconds on stainless-steel pipe with 12 mm diameter	90 mm	32 cm	P03652908	SK8
Magnetic sensor	-50°C to 200°C	Cl. 2	7 s	4 mm	1 m	P03652922	SK19

Standard compensated miniature male 2-pole connector
 Spiral cable: 45 cm to 1m



EXTENSIONS FOR THERMOCOUPLES

	CK 1	CK 2	CK 3	CK 4
Models	Description			Length
CK 1	Terminated by male plug / female plug		4 mm	1 m
CK 2	Terminated by male plug / 2 bare wires		4 mm	1 m
CK 3	Terminated by 5-pin DIN plug / female socket		4 mm	1 m
CK 4	Terminated by 2 banana plugs / female socket		4 mm	1 m

Temperature withstand of extensions: -40 °C to +100 °C



CK 3 CK 2 CK 1 CK 4

REFERENCES TO ORDER

- CK 1 _____ P03652909
- CK 2 _____ P03652910
- CK 3 _____ P03652913
- CK 4 _____ P03652914

ACCESSORIES / REPLACEMENT PARTS

- PP1 handle for CK extensions _____ P03652912
- Compensated miniature male 2-pole connector _____ P03652925



CAPTEURS DE TEMPÉRATURE PT 100 Ω

- Pt 100 Ω temperature sensors

Models	Type	Type / Application	Description	Measurement range	Classe de tolérance	Response time	∅	Length	Ref.
	SP 10	Surface sensor with spring	For flat surfaces The spring ensures optimum contact, even if the sensor is not set up perpendicularly.	-50 °C to +200 °C	Cl. B	6 s	5 mm	13 cm	P03652712
	SP 11	Needle sensor	For penetration (20 mm minimum) in pasty, viscous or liquid media.	-100 °C to +600 °C	Cl. B	7 s	3 mm	13 cm	P03652713
	SP 12	Air sensor	Suitable for all ambient air measurements (moving air). If the air is stationary, agitate the sensor to favour heat exchange.	-100 °C to +600 °C	Cl. B	5 s	5 mm	13 cm	P03652714
	SP 13	Immersion sensor	Sensor with stainless-steel sheath specially designed for liquids	-100 °C to +600 °C	Cl. B	7 s	3 mm	13 cm	P03652715
	SP 14	General-purpose sensor	316L stainless-steel sensor for general use	-40 °C to 450 °C	Cl. A	7 s	3 mm	20 cm	P01655020

Accuracy class A / 0.15 °C + 0.002 x T °C
 Accuracy class B / 0.3 °C + 0.005 x T °C
 Miniature 3-pole flat-pin connector
 Spiral cable from 45 cm to 1m



CALIBRATORS

C.A 1621, C.A 1623 and C.A 1631

■ Mains power supply	P01103057
■ MultiFix bag 120 x 245 x 60 mm	P01298075
■ Set of 2 red/black crocodile clips	P01295457Z
■ Set of 2 red/black moulded PVC leads	P01295451Z
■ Set of 2 moulded test probes \varnothing 4 mm	P01295458Z

THERMAL CAMERAS

C.A 1882

■ Battery	P01296045
■ Battery charger	P01296046
■ Bag	P01298075
■ Docking station	P01651528
■ Mains power supply	P01651527
■ Sun shade	P01651532
■ In-vehicle charger adapter	HX0061

C.A 1886 and C.A 1888

■ Sun shade	P01651531
■ Photo tripod adapter	P01651526
■ Lens cover	P01651522
■ USB cable	P01295274
■ Battery	P01296041
■ Battery charger	P01296043
■ Mains power supply	P01651527
■ In-vehicle adapter (cigarette lighter)	HX0061

THERMOMETERS

C.A 1821, C.A 1822 and C.A 1823

■ Shockproof sheath + Multifix	P01654252
■ Multifix	P01102100Z
■ Mains adapter	P01651023
■ Bag	P01298075
■ Metal case	P01298071
■ Dataview® software	P01102095
■ Bluetooth BLE / USB modem for PC	P01654253

THERMO-HYGROMETER

C.A 1246

■ 75%RH salt cartridge	P01156401
■ 33%RH salt cartridge	P01156402
■ Shockproof sheath + Multifix	P01654252
■ Multifix	P01102100Z
■ Mains adapter	P01651023
■ Bag	P01298075
■ Metal case	P01298071
■ Dataview® software	P01102095
■ Bluetooth BLE / USB modem for PC	P01654253

THERMO-ANEMOMETER

C.A 1227

■ Cones kit for vane flow-rate measurement (circular cross-section \varnothing 210mm and rectangular cross-section 346x346mm)	P01654250
■ Vane sensor \varnothing 80mm	P01654251
■ Shockproof sheath + Multifix	P01654252
■ Multifix	P01102100Z
■ Mains adapter	P01651023
■ Bag	P01298075
■ Metal case	P01298071
■ Dataview® software	P01102095
■ Bluetooth BLE / USB modem for PC	P01654253

LUXMETER

C.A 1110

■ Shockproof sheath + Multifix	P01654252
■ Multifix	P01102100Z
■ Mains adapter	P01651023
■ Bag	P01298075
■ Metal case	P01298071
■ Dataview® software	P01102095
■ Bluetooth BLE / USB modem for PC	P01654253

MULTI-FUNCTION INSTRUMENT

C.A 1052

■ Straight extension	P01102010
■ Elbowed extension	P01102011
■ Telescopic extension	P01102012
■ Rotating-vane flow-rate cone	P01173105
■ C.A 828 hot-wire flow-rate cone	P01173107
■ Pitot tube	P01102048
■ Case	P01298072



SOUND-LEVEL METERS

C.A 832 and C.A 834

- C.A 833 94 dB or 114 dB sound-level meter calibrator _____ P01185301
- Microphone extension for C.A 834 (5 metres) _____ P01102085
- Wind cap _____ P01102083
- Jack/USB cable for C.A 834 _____ P01295478

TACHOMETERS

C.A 1725 and C.A 1727

- Mechanical accessories kit _____ P01174902
- End-fittings (set of 3) _____ P01174903
- Reflective tape (15 x 0.1 m strips) _____ P01101797
- FRB F socket _____ P01101785
- TACHOGRAPH software on CD-ROM _____ P01174835
- USB-A to USB-B cable _____ P01295293

CO₂, TEMPERATURE & HUMIDITY LOGGER**C.A 1510**

- In-situ calibration kit _____ P01651022
- Hard case _____ P01298071
- Desk stand _____ P01651021
- Wall support _____ P01651020
- USB mains adapter _____ P01651023
- USB-Bluetooth adapter _____ P01102112

CO DETECTOR

C.A 895

- Aspiration kit with pump and extension _____ P01651101

FIND ALL OUR ACCESSORIES ON PAGE 230



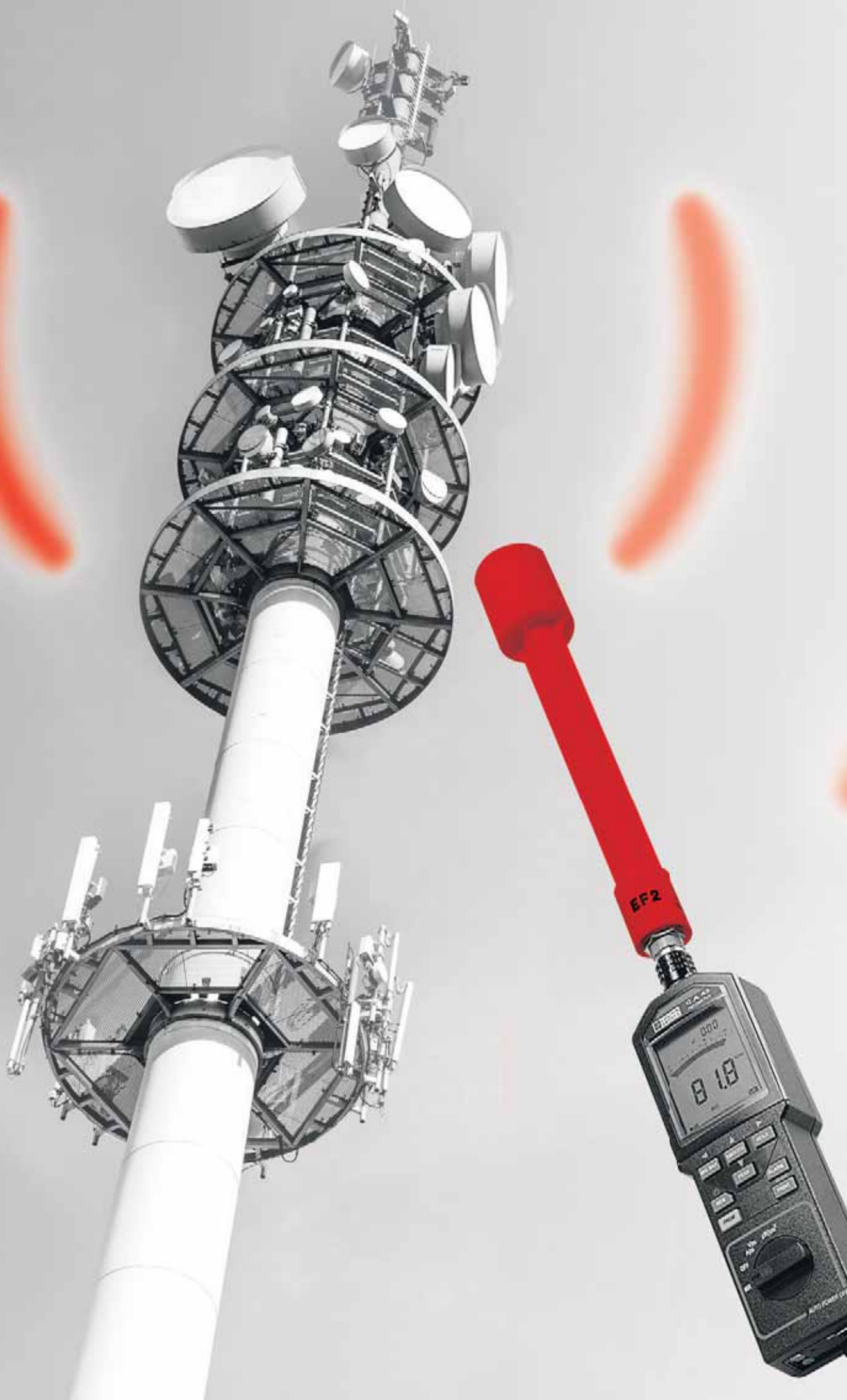

RADIOFREQUENCY & MICROWAVE MEASUREMENTS

Info and advice	196
LAN tester	199
Fieldmeters	200
Wattmeters / reflectometers	202
Accessories	203



COMPUTER NETWORK AND TELECOM TESTING

The wiring of a physical infrastructure may be defined as a set of specific elements through which it is possible to transfer information. Usually linked to computer networks,

the performance requirements of wiring systems are evolving rapidly and they must now be capable of conveying other types of information, such as voice or video.

COPPER NETWORK WIRING

A category-5 or higher network cable comprises an external sheath, 8 copper wires organized in 4 pairs and an earth wire. There are different levels of cable shielding, with shielding per pair, global shielding or both.

THE RJ45 CONNECTOR

This connector with 8 positions and 8 electrical contacts is very widely used to terminate cables with twisted pairs:

THE DIFFERENT TYPES OF CABLES

The ISO/IEC 11801 standard defines official naming conventions for copper cables. The names describe the global protection of the cable, on the one hand, and the protection of the pairs of copper conductors, on the other.

Copper cables are named as follows: X / Y TP

X: Global protection of the cable

Y: Protection of the pairs

TP: Twisted Pairs

The following values are possible for X and Y:

U = Unshielded, no protection

S = Shielded with a tin-plated braid

F = Foiled, shielded with aluminium foil

		Shielding efficiency
U/UTP Global shielding: None (U) Shielding per pair: None (U)		☹☹☹
F/UTP Global shielding: Aluminium foil (F) Shielding per pair: None (U)		☹☹
SF/UTP Global shielding: Tin-plated braid and aluminium foil Shielding per pair: None (U)		☹
U/FTP Global shielding: None (U) Shielding per pair: Aluminium foil (F)		😊
F/FTP Global shielding: Aluminium foil (U) Shielding per pair: Aluminium foil (U)		😊😊
S/FTP Global shielding: global tin-plated braid Shielding per pair: Aluminium foil per pair		😊😊😊

MODULAR MALE RJ45 JACK SOCKET

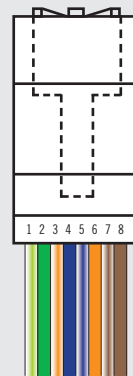

T568A
(clip below)



T568B
(clip below)

EIA/TIA 568A standard		
Name	No.	Colour
TD+	1	White/Green
TD-	2	Green
RD+	3	White/Orange
Not used	4	Blue
Not used	5	White/Blue
RD-	6	Orange
Not used	7	White/Brown
Not used	8	Brown

EIA/TIA 568B standard		
Name	No.	Colour
RD+	1	White/Orange
RD-	2	Orange
TD+	3	White/Green
Not used	4	Blue
Not used	5	White/Blue
TD-	6	Green
Not used	7	White/Brown
Not used	8	Brown



MEASUREMENT OF ELECTROMAGNETIC FIELDS

Any system using electricity as an energy source generates electromagnetic radiation when it is in operation. Depending on the design of the system, the electromagnetic fields which it produces may be propagated in the space around it, extending significantly further than the external limits defined by its enclosure (casing) or the site where it is installed. This is the case for electrical machinery, motors, welding units, induction furnaces, high-voltage power lines, transformer stations, household electrical appliances and electronic instruments used for data processing, transmission, monitoring or measurement. These electromagnetic fields

interact with matter, both inanimate (interference with nearby electrical devices) and animate (plants, animals, etc.). It is therefore important to be able to measure the values of the radiated magnetic and electric fields propagated around any electrical or electronic device:

- to overcome the purely technical problems linked to the electromagnetic compatibility of instruments and machines,
- but also to make sure that the people living and working near these electrical systems are not exposed to fields liable to cause lasting or even temporary negative effects on them.

THE ELECTROMAGNETIC WAVE

The electromagnetic wave is **the radiated energy produced by the oscillation of an electrical load**. It is characterized by oscillation of the electrical and magnetic fields. Each system generating or absorbing electrical energy is the source of electromagnetic waves in the form of variable electric fields and magnetic fields which are propagated in the air at the speed of light.

Roughly speaking, an electromagnetic wave comprises:

The electric field (E): generated by the difference in potential between two conductors subjected to an electrical voltage, this field depends on the voltage V.

The magnetic field (H): as this field is generated by a current in a conductor, it depends on the current i.

In the case of a sinusoidal alternating wave, the electric field E and the magnetic field H are sinusoidal and in phase. Their directions are perpendicular to one another and perpendicular to the direction of propagation.

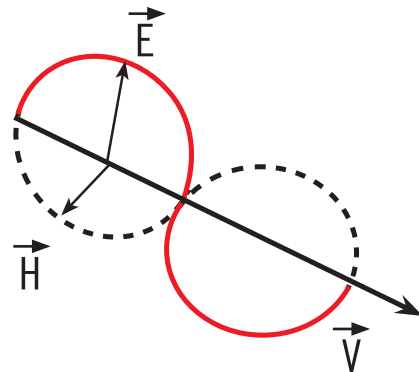

Representation of the three components of an electromagnetic wave

This wave is characterized by its frequency F in Hertz (Hz) or its wavelength in metres; these two quantities are linked by the following relation:

$$\lambda = C_0 / F$$

where C_0 = the speed of light in m/s,
i.e. 300,000 km/s = 3×10^8 m/s

F = frequency in Hz

λ = wavelength in m

Example: for a wave at 300 MHz, the wavelength is 1 metre.

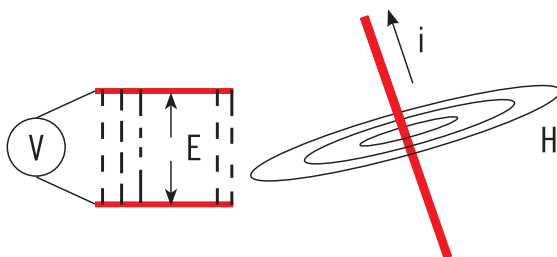



MEASUREMENT OF ELECTROMAGNETIC FIELDS

THE ELECTROMAGNETIC SPECTRUM

The electromagnetic spectrum is the decomposition of the electromagnetic radiation into its different components in terms of wavelength. Some waves can be detected with

the human eye, while others have much lower frequencies detectable using radio devices.

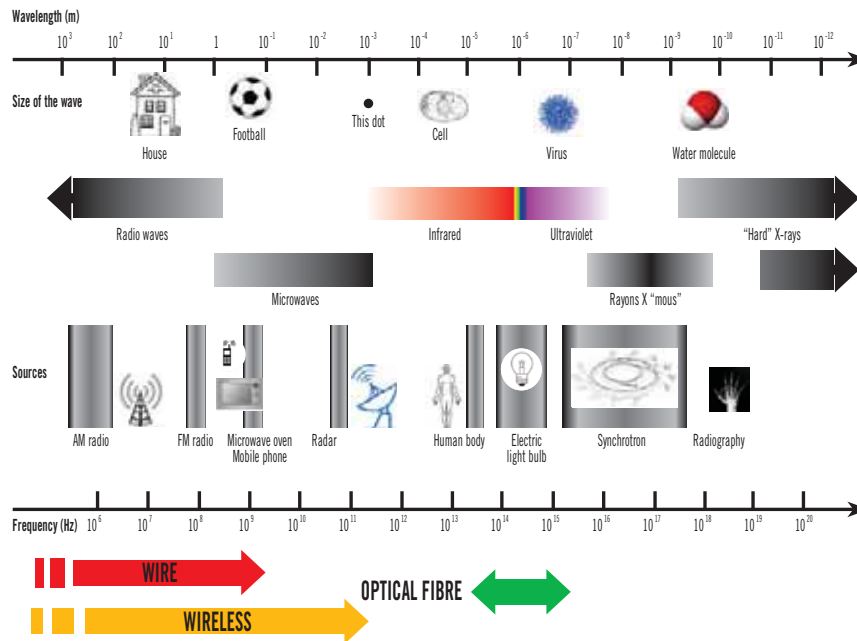

INTERACTIONS WITH MATTER

The effects of electric and magnetic fields on matter and tissues vary according to their frequency and their intensity. Low-frequency fields are liable to induce electric currents in matter and biological tissues.

Effects described as "thermal" may follow. These thermal effects are the basis for the action of higher-frequency fields used in certain applications (cooking and drying with microwaves).

OBLIGATIONS

The International Commission on Non-Ionizing Radiation Protection (ICNIRP) has defined exposure limits adopted in many countries. The exposure limits adopted by the European Community are based on a recommendation issued by the ICNIRP, including those in Directive 1999 / 519 / CE (public) and the recent directive 2013/35/UE of 26th June 2013 concerning workers' exposure to electromagnetic fields, which must be transposed into law in the member states by 1st July 2016. For the latter directive, the employer's role will be to assess the hazards and determine the exposure which can be measured in order to find out objectively whether the standard recommended thresholds have been exceeded or not.



C.A 7028

Ref. : P01129501

**RJ
45**

STRENGTHS

- Graphical screen
- Detects, identifies and locates faults from up to 150 m away
- Designed for use on UTP, STP, FTP, & SSTP cables equipped with RJ45 connectors and wired in compliance with the TIA 568A/B, USOC or ISDN specifications

SPECIFICATIONS

	C.A 7028
Connector	RJ 45
Types of cables	UTP, STP, FTP & SSTP
Faults indicated	Short-circuited pair, Wire in open circuit, Short-circuit between pairs, Crossed pairs, Reversed pairs, Shielding continuity
Remote modules	Identifiers nos. 1 to 9
Dimensions	165 x 90 x 37 mm
Weight	350 g

ACCESSORIES / REPLACEMENT PARTS

- Set of 4 identifiers nos. 2 to 5 P01101994
- Set of 4 identifiers nos. 6 to 9 P01101995
- See all the accessories on page 203

CONTENTS

- C.A 7028 delivered with:
- 2 RJ45 leads
- 1 identifier no. 1
- 1 soft case
- 4 x 1.5 V LR06 batteries



LOW-FREQUENCY FIELDMETER

**C.A 40**

Ref.: P01167501

STRENGTHS

- Measurement of low-frequency magnetic fields
- Quick assessment of the radiation from equipment and installations
- Easy-to-handle unidirectional probe

SPECIFICATIONS

	C.A 40		
Magnetic field measurement	20 μT	200 μT	2,000 μT
Accuracy	±(4 % + 3 cts)	±(5 % + 3 cts)	±(10 % + 5 cts)
Frequency range	30 to 300 Hz		
Power density	-		
Output	-		
Probe	Unidirectional		
Alarm	-		
Data storage	-		
Dimensions	163 x 68 x 24 mm		
Weight	285 g		

CONTENTS

- 1 probe
- 1 x 9 V 6LR61 battery

ACCESSORIES / REPLACEMENT PARTS

- Soft case _____ P01298036



C.A 41 - C.A 43

Ref.: P01167001B

P01167002A

STRENGTHS

- Measurement of electric fields and detection of radiation sources over a wide frequency band
- Isotropic probe: measures the field in all directions
- Storage of measurement points with the C.A 43

SPECIFICATIONS

	C.A 41		C.A 43	
	Electric field measurement	0.1 to 1 V/m	1 to 10 V/m	10 to 100 V/m
Accuracy	0.7 V/m	0.5 V/m	1 dB	2 dB
Frequency range	100 kHz to 2.5 GHz			
Power density	-		0.1 to 2 mW/cm ²	
Output	Analogue		Digital on optical fibre	
Probe	Isotropic			
Alarm	Configurable high and low thresholds			
Data storage	-		1,920 points	
Dimensions	216 x 72 x 37 mm			
Weight	350 g			

CONTENTS

- **C.A 41** delivered with:
 - 1 hard case
 - 1 EF2A probe
 - 1 x 9 V 6LR61 battery
- **C.A 43** delivered with:
 - 1 hard case
 - 1 EF2A probe
 - Optical fibre
 - 1 PC adapter
 - 1 CD-ROM containing data processing software
 - 1 x 9 V 6LR61 battery

ACCESSORIES / REPLACEMENT PARTS

- EF2A isotropic probe _____ P01167202B
- Shockproof sheath _____ P01298009B
- See all the accessories on page 203



RW 511 - RW 5012 - RW 501

Ref.: P01255102

P01255104

P01255101

RW 521

Ref.: P01255103

STRENGTHS

Wattmeters developed for military and civilian applications:

- Simple installation testing
- Testing of the assembly comprising the transmitter, cable and antenna
- 1 product for each market:
 - Single side-band transmission (RW 511)
 - VHF networks, police, emergency services (RW 5012)
 - Radio, FM and TV networks (RW 501)
 - Rural VHF – HF networks (RW 521)

SPECIFICATIONS

	RW 521	RW 511	RW 5012	RW 501
Frequencies	1.3 ... 2.7 GHz	2 ... 30 MHz	25 ... 500 MHz	25 ... 1,300 MHz
Incident power	+10 ... +40 dBm	30 ... 1,000 W	1 ... 300 W	1 ... 300 W
Reflected power	+5 ... +35 dBm	10 ... 300 W	0.3 ... 100 W	0.3 ... 100 W
Accuracy	± 6 %	± 7.5 %	± 6 %	± 6 %

CONTENTS

- RW 511 delivered with:
 - 1 x 9V 6LR61 battery
- RW 5012, RW 501 and RW 521 delivered with:
 - 2 x 1.5 V LR06 batteries

ACCESSORIES / REPLACEMENT PARTS

- Bag P01298046
- SWR chart for RW 501, 511 & 5012 P01255901
- See all the accessories on page 203



LAN TESTER

C.A 7028

- Set of 4 identifiers nos. 2 to 5 _____ P01101994
- Set of 4 identifiers nos. 6 to 9 _____ P01101995
- Bag _____ P01298532

WATTMETERS/REFLECTOMETERS

RW 511, RW 5012, RW 501 and RW 521

- Bag _____ P01298046
- SWR chart for RW 501, 511 & 5012 _____ P01255901
- SWR chart for RW 521 _____ P01255902

FIELDMETERS

C.A 40

- Soft case for C.A 40 _____ P01298036

C.A 41 and C.A 43

- EF2A isotropic probe _____ P01167202B
- Shockproof sheath _____ P01298009B

FIND ALL OUR ACCESSORIES ON PAGE 230



10 A

3 A

1 A

300 mA

100 mA

30 mA

10 mA

3 mA

1 mA

300 μ A

100 μ A

100 mV

CHAUVIN
ARNOUX



LABORATORY & EDUCATIONAL INSTRUMENTATION

Info and advice

206

Training benches

207

Training cases

210

Other instruments

213



Electricity, electronics, physics, industrial maintenance & the environment: these are disciplines where **measurement is crucial for identifying and understanding** theoretical phenomena through practical experience. We offer **simple,**

educational equipment to help students to learn about subjects ranging from the study of electrical signals to the maintenance of electrical systems.

STUDYING SIMPLE ELECTRICAL PHENOMENA

In Electronics training, students discover the techniques using electrical signals to capture, transmit, process, store and view data. To help them, **the electrical quantities may be generated by decade boxes or simulation cases.** These quantities are measured by traditional measuring instruments such as voltmeters, ammeters, wattmeters and multimeters.

These resistance, capacitance or inductance decade boxes are passive elements for insertion into test or development circuits in order to obtain the required resistance, capacitance or inductance values by combination.



Quantity	Unité
Resistance R	Ω (ohm)
Current I	A (ampere)
Voltage V	V (volt)
Power P	W (watt)
Capacitance C	F (farad)
Inductance L	H (henry)



COMPLIANCE WITH THE IEC 61010-1 STANDARD

These **decade boxes comply with the IEC 61010-1 safety standard** which establishes the safety rules for electrical measuring, control and laboratory instruments.

This standard defines the normal environmental conditions of use:

- Indoor use
- Altitude up to 2,000 m
- Temperature from 5 °C to 40 °C

- Maximum relative humidity of 80 % at temperatures up to 31 °C, with a linear decrease down to 50 % relative humidity at 40 °C
- Fluctuations of the network supply voltage from the network not exceeding ± 10 % of the rated voltage
- Normal presence of transient overvoltages on the network power supply

PRACTICAL APPLICATIONS ENCOURAGE SUCCESSFUL LEARNING

Electrical installation cases, power and harmonics cases, microwave test benches and an **infrared thermography bench**: Chauvin Arnoux provides students with **ready-to-use** educational units which are ideal **for a large number of experiments.**

Their overall design aims to ensure simple use and measurements. **Delivered with a guide containing practical exercises** accompanied by the corresponding theoretical elements, these training cases enable students to boost their knowledge with practical skills likely to prove useful during their careers.

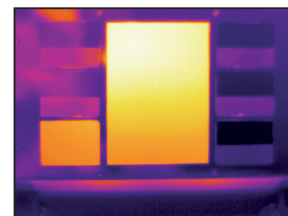



C.A 1875

Ref. : P01651620

**PRACTICAL
EXERCISES**

STRENGTHS

- Highlighting of the various possible errors in thermography: problems linked to emissivity, spatial resolution, angle of measurement, transmission or reflection
- Simple use and simple measurements
- Delivered with a booklet of practical exercises accompanied by the corresponding theoretical principles

SPECIFICATIONS

	C.A 1875
Emissivity of materials	The influence of emissivity on temperature measurement is demonstrated using sheets of different materials
Positioning	Visual demonstration of the influence on temperature measurement of camera positioning in relation to the target
Reflection and transmission	Visual demonstration of reflection and transmission phenomena and their influence
Spatial resolution	Detection of minimum areas for temperature measurement according to the distance from the target
Power supply	230 V – 50 / 60 Hz

CONTENTS

- C.A 1875 delivered in a bag with:
- 1 mains power cable
- Test sheets
- 1 booklet presenting the theoretical principles and practical exercises



ORITEL CF 204 GUNN power supply

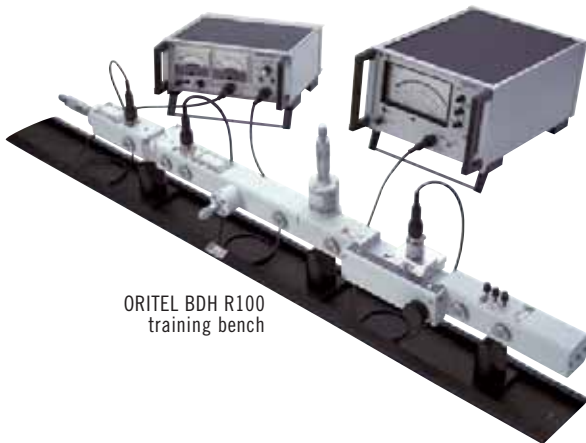

ORITEL BDH R100 training bench



BDH R100

Ref.: P01275101



STRENGTHS

- Dedicated to teaching about 8.5 to 9.6 GHz microwaves with guided propagation
- WR90/R100 waveguide equipped with a quick mounting system
- Supplied with detailed course, teaching and lab work material
- Various accessories for setting up a wide range of experiments

SPECIFICATIONS

BDH R100	
Main possible experiments	
Study	GUNN oscillator
	Impedance
Measurements	Wavelength
	Frequency
	Standing wave ratio
Readings	Quadratic law of a detector

CONTENTS

- BDH R100 delivered in a case with:
 - 1 ORITEL OSG 100 GUNN diode oscillator
 - 1 ORITEL ISO 100 ferrite isolator
 - 1 ORITEL MOD 100 PIN diode modulator
 - 1 ORITEL ATM 100 variable attenuator
 - 1 ORITEL OND 100 cavity wavemeter with curve
 - 1 ORITEL LAF 100 measuring line
 - 1 ORITEL ADZ 100/3 impedance adapter
 - 1 ORITEL TGN 100 waveguide-to-coaxial transition element
 - 1 ORITEL DEN 100 coaxial detector
 - 1 ORITEL CHG 100 adapted load
 - 1 ORITEL CC 100 short-circuit plate
 - 3 ORITEL SUP 100 guide supports

ELEMENTS FOR FREE-SPACE PROPAGATION

		Reference
1	20 dB ANC 100/20 horn antenna	P01275326
2	15 dB ANC 100/15 dB horn antenna	P01275304
3	10 dB ANC 100/10 horn antenna	P01275325
4	RRL100 passive radar responder	P01275333
5	DR100 reflector disk	P01275334
6	AND100 dielectric antenna	P01275329
7	ASP100 patch antenna	P01275328
8	ANF100 adjustable slot antenna	P01275332
	ANF100F fixed slot antenna	P01275331
	IANF100 iris for adjustable slot antenna	P01275330
	ANP100 adjustable parabolic reflector	P01275327
9	ANP100F fixed parabolic reflector	P01275335



ADDITIONAL COMPONENTS

		Reference
1	ORITEL RD 100 displacement copy (for ORITEL LAF 100 measuring line)	P01275302
2	DPH100 micrometer phase shifter	P01275340
3	JTG100 rotating joint	P01275338
4	CIR100 ferrite circulator	P01275344
5	DEG100 parallel detector on guide	P01275345
6	PEH100 E-H positioner	P01275358
7	GD100/180 180 mm straight waveguide	P01275350
8	COE100/H high plane E bend COE100/B low plane E bend COH100 plane H bend	P01275346 P01275347 P01275348
9	CCM100 micrometer short-circuit	P01275351
10	Calibrated attenuator	P01275339
11	LAZ100 movable impedance adapter	P01275352
12	KED100 dielectric kit	P01275353
13	CDT100 multi-hole directional coupler ICDT100/30: 30 dB iris for multi-hole coupler	P01275341 P01275343
14	CAB100: 1 m coaxial cable	P01275357



ACCESSORIES / REPLACEMENT PARTS

		Reference
ORITEL OSG 100 GUNN diode oscillator	Voltage: 10 VDC - Power: +17 dBm	P01275307
ORITEL MOD 100 PIN diode modulator	Modulation depth > 50% for I = +10 mA	P01275309
ORITEL OND 100 cavity wavemeter with curve	Reading accuracy: 5 MHz	P01275311
ORITEL LAF 100 measuring line	Residual SWR: < 1.05	P01275312
ORITEL DEN 100 coaxial detector	SWR: < 1.3 - Max. power: +19 dBm	P01275315
ORITEL ISO 100 ferrite isolator	Isolation: > 20 dB	P01275308
ORITEL ATM 100 micrometer attenuator	Attenuation: > 20 dB - Max. power: 1 W average	P01275310
ORITEL ADZ 100/3 impedance adapter	Number of transverse plates: 3	P01275313
ORITEL TGN 100 waveguide-to-coaxial transition element	SWR: < 1.25	P01275314
ORITEL CHG 100 adapted load	SWR: < 1.05	P01275316
ORITEL CGX 100/20 dB cross coupler	Coupling: 20 dB - Directivity: 15 dB typ.	P01275305
IRIS 100 coupling iris (for CGX100)	20 and 30 dB coupling	P01275306
ORITEL ANC 100/15 dB horn antenna	Gain: 15 dB Flange: UBR 100/UG 39	P01275304
ORITEL AFR 100	Compatible with UBR 100 / UG 39 flanges	P01275301
ORITEL RD 100 displacement copy	For ORITEL LAF 100 measuring line	P01275302

* You are advised to use the GUNN CF204 power supply to power GUNN diode oscillators safely

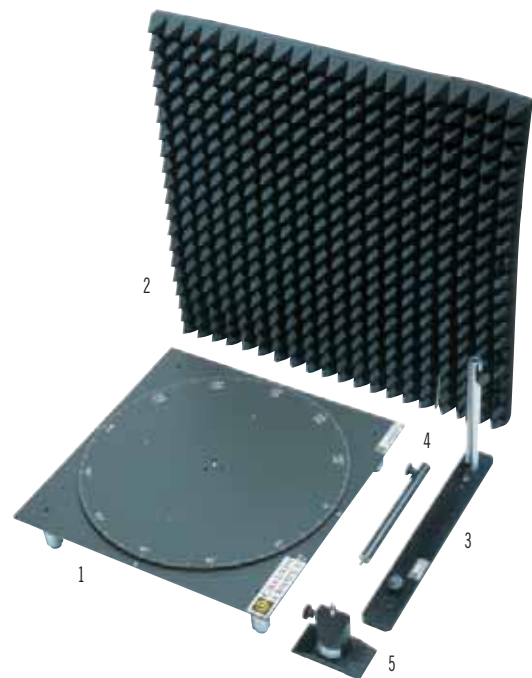

ACCESSORIES / REPLACEMENT PARTS

		Reference
1	Manual rotating platform – PTM100	P01275359
2	Set of 2 absorber panels – ABS100	P01275362
3	Antenna support – SAN100	P01275360
4	Antenna support rod	P01275349
5	Waveguide support – SUP100	P01275318
	Experiment frame	P01275361



CHOOSE YOUR TRAINING CASE



C.A 6710 case

page 211



Power & Harmonics Case

page 212

Electrical installation testing and safety

- Earth/ground
- Soil resistivity
- Loop
- Insulation
- RCD
- Leakage current

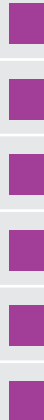

Power and Harmonics

- Single & three-phase currents
- Single & three-phase voltages
- Active, reactive and apparent power, $\cos \phi$, PF...
single and three-phase
- Voltage variation
- Current variation
- Current phase-shift variation
- THD variation on voltage and current





C.A 6710

Ref.: P01145901

ELECTRICAL INSTALLATIONS

STRENGTHS

- Ideal for learning about electrical safety measurements
- Simulation of measurements on electrical installations
- Depressurization valve for air transport

SPECIFICATIONS

	C.A 6710
Standards illustrated	NF C 15-100, VDE 0100, IEE 16th, IEC 64-8, ÖVE EN-1, RBT MIE, NIN/NIV...
Simulation of earthing systems	TT, TN and IT
Measurement simulations	Earth, resistivity, loops (earth and internal), insulation, RCD tests (30 mA / 300 mA), current / leakage current
Fault simulations	Phase / neutral or earth interruptions, neutral / earth reversal, leakage current
Electrical safety	Cat. II 230 V
Dimensions	490 x 395 x 195 mm
Weight	10 kg

CONTENTS

- C.A 6710 delivered with:
- 1 x Schuko-type FR-DE mains power cable
- 6 black safety leads 25 cm long with rear connection
- 1 universal adapter for mains power sockets
- 1 FR/DE adapter for mains power sockets

ACCESSORIES / REPLACEMENT PARTS

- Set of 6 black Ø 4 male safety leads 25 cm long with rear connection _____ P01295212
- 1 universal adapter for mains power sockets _____ P01101980
- 1 FR/DE adapter for mains power sockets _____ P01101981



POWER & HARMONICS

Ref.: P01NC5003

POWER AND HARMONICS

STRENGTHS

- Hazard-free simulation of a network and a three-phase load
- Variable currents, voltages, phase shift and THD

SPECIFICATIONS

	Power & harmonics
Network simulations	SINGLE or THREE--phase (230 V mains power supply)
Measurement simulations	U, I, W, W/h, var, φ , THD, etc.
Voltage	Mains $\pm 15\%$
Current	1, 2, 5, 10, 20 A $\pm 10\%$
Voltage variation*	+8% ; -10%
Current phase shift*	30°, 45°, 60° $\pm 5^\circ$ inductive or capacitive
Harmonic distortion on current and voltage*	Network level, 15 %, 25 % and variable
Phase outage	Yes
Power supply	230 V mains - 2 P + E socket
Electrical safety	IEC 61010 300 V Cat II pollution 2
Dimensions	490 x 395 x 195 mm
Weight	10 kg

*on phase I

CONTENTS

- Case delivered with:
- 1 mains power cable

ACCESSORIES / REPLACEMENT PARTS

- Measurement leads [page 220](#)

ADDITIONAL INFO

- The current sensors are not delivered with the training case.



CHOOSE YOUR INSTRUMENT FOR SIMULATING THE ELECTRICAL QUANTITIES



C.A 401

C.A 402

C.A 403

C.A 404

C.A 405

C.A 406

DECADE BOXES

SHUNT

WHEATSTONE

page 214

page 214

page 214

page 214

page 214

page 214

page 215

page 215

page 215

page 215

page 215

page 217

page 215

Specifications

AC / DC ammeter	■											
AC / DC voltmeter		■										
Null galvanometer			■									
Single/three-phase wattmeter				■	■							
Multimeter					■							
1-decade resistance box						■						
1-decade capacitance box							■					
Multi-decade resistance boxes								■				
Multi-decade capacitance boxes									■			
Multi-decade inductance boxes										■		
Shunts											■	
Wheatstone bridge (sub-assembly for)												■



ANALOGUE TESTERS



C.A 401 - C.A 402 - C.A 403

Ref.: P01170301 P01170302 P01170303

C.A 404 - C.A 405 - C.A 406

Ref.: P01170304 P01170305 P01170501



STRENGTHS

- Economical and rugged
- Resistant casing with removable stand
- Single switch
- Safety sockets
- Double insulation

CONTENTS

- C.A 401, C.A 402, C.A 403, C.A 404 and C.A 405 delivered with:
 - 1 x 1.5 V LR06 battery
- C.A 406 delivered with:
 - Test-probe leads
 - 1 x 1.5 V LR06 battery
- C.A 406 kit version P01170701

ACCESSORIES / REPLACEMENT PARTS

- Shockproof sheath no. 13 P01298016
- Fuses page 230
- Measurement leads page 230

SPECIFICATIONS

	C.A 401	C.A 402	C.A 403	C.A 404	C.A 405	C.A 406
Function	AC/DC ammeter	AC/DC voltmeter	Null galvanometer 2 black scales (0 to 30 and 0 to 100)	Single-phase AC/DC wattmeter	Single and three-phase AC/DC wattmeter	Multimeter with 6 black, green and red scales
Switchgear	Magneto-electric rectifying		Magneto-electric	Ferrodynamic		Magneto-electric
Calibres						
Voltage	100 mV DC cal. for shunts	8 DC cal.: 100 mV to 1,000 V* 6 AC cal.: 3 V to 1,000 V*	1 DC cal.: 100 mV for shunts	4 cal.: 60 V to 480 V	6 single-phase cal.: 60 V to 480 V 4 balanced three-phase cal.: 60 V/√3 to 240 V/√3	8 DC cal.: 100 mV to 1,000 V* 6 AC cal.: 3 V to 1,000 V*
Current	11 DC cal.: 100 µA to 10 A 7 AC cal.: 10 mA to 10 A		2 DC cal.: 30 µA, 3 mA	2 cal.: 0,5 A; 1 A	1 cal. 5 A	4 DC cal.: 1 mA to 1 A & 1 cal. 50 µA 5 AC cal.: 0.3 mA to 3 A & 1 cal. 150 µA
Resistance						3 cal.: 0.5 Ω 1 kΩ to 1 MΩ
Basic accuracy	2 % DC 2,5 % AC		1,5 % DC	1 % AC	2,5 % DC. 1 % AC mono. et 2 % AC tri.	1,5 % DC
Operating frequency	45 to 400 Hz	20 to 400 Hz		0 to 500 Hz	15 to 500 Hz	20 to 400 Hz
Fuses	1 A HPC and 10 A HPC	Internal resistance: 20 kΩ/V _{DC} ; 6.32 kΩ/V _{AC}	315 mA HPC	1,25 A HPC	6,3 A HPC	3.15 A HRC and 160 mA HRC int. res.: 20 kΩ/V _{DC} ; 6.32 kΩ/V _{AC}
Electrical safety	600 V CAT III as per IEC/EN 61010-1 Edition 2					
Dimensions	165 x 105 x 50 mm					
Weight	450 g					

*Use limited to 600 V maximum

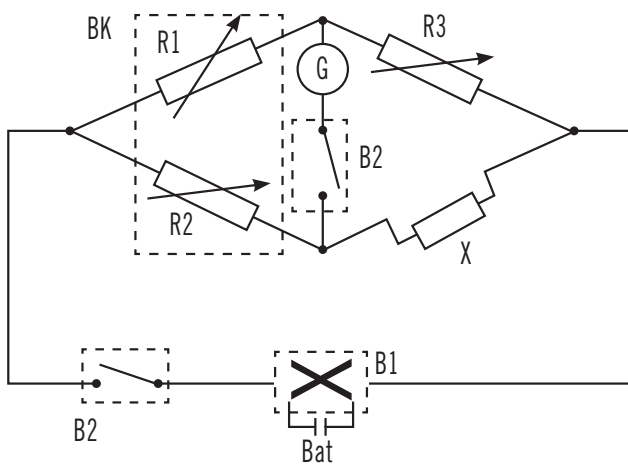

G = null galvanometer
 BK = K ratio box - with $K = \frac{R2}{R1}$
 R3 = resistance boxes
 X = resistance to be measured - with $X = K \times R3$
 B1 = simple changeover-switch box
 B2 = dual switch box
 Bat = battery

RESISTANCE BOXES

	References
1 decade	
0,1 to 1 Ω	P03197521A
1 to 10 Ω	P03197522A
10 to 100 Ω	P03197523A
100 to 1,000 Ω	P03197524A
1 to 10 k Ω	P03197525A
10 to 100 k Ω	P03197526A
100 to 1,000 k Ω	P03197527A
1 to 10 M Ω	P03197528A
BR 04 : 4 decades 1 Ω to 10 k Ω	P01197401
BR 05 : 5 decades 1 Ω to 100 k Ω	P01197402
BR 06 : 6 decades 1 Ω to 1 M Ω	P01197403
BR 07 : 7 decades 1 Ω to 10 M Ω	P01197404

CONTENTS

- 1-decade box delivered with 1 black safety lead 25 cm long, \varnothing 4 mm male with rear connection
- BR 04/05/06/07 boxes are delivered with a user manual only.

ACCESSORIES / REPLACEMENT PARTS

- 1 black safety lead 25 cm long, \varnothing 4 mm male with rear connection P01295056
- Black \varnothing 4 mm male jumper (x10) P01101892A

ASSEMBLY FOR WHEATSTONE BRIDGE

	References
7-ratio K box	P03197531A
Null galvanometer	P03197611A
Dual switch box	P03197529A
Simple changeover-switch box	P03197530A

**IEC/EN6110-1 - 150 V CAT II - PoI 2
 50 V CAT III**



DECADE BOXES AND SHUNTS



CAPACITANCE BOXES

STRENGTHS

Elements for mechanical and electrical assemblies

- Selection by rotary switch with contacts
- Typical accuracy: 2%

1-decade boxes

- 3 boxes with 11-position switch (including position 0)
- 2 safety terminals \varnothing 4mm and one earth terminal
- Dimensions: 72x72x90 mm

5-decade box

- Polystyrene and polypropylene high-accuracy capacitors with a temperature coefficient of 125 ppm/°C and a very high insulation resistance
- Output: \varnothing 4mm safety sockets
- Metal front panel and casing connected to a safety earth socket with foolproofing

	References
1 decade	
0.01 to 0.1 μ F	P03199613A
0.1 to 1 μ F	P03199612A
1 to 10 μ F	P03199611A
BC 05 : 5 decades 0.1 nF to 10 μ F	P01197421

CONTENTS

- 1-decade box delivered with:
- 1 black safety lead 25 cm long, \varnothing 4 mm male with rear connection
- BC05 box delivered with a user manual only.

ACCESSORIES / REPLACEMENT PARTS

- 1 black safety lead 25 cm long, \varnothing 4 mm male with rear connection _____ P01295056
- Black \varnothing 4 mm male jumper (x10) _____ P01101892A

**IEC/EN6110-1 - 150 V CAT II - Pol 2
50 V CAT III**



DECADE BOXES AND SHUNTS

INDUCTANCE BOXES



BL 07 :	7 decades from 1 μ H to 10 H	References
		P01197451

CONTENTS

- BL07 box delivered with a user manual only

100 MV SAFETY SHUNTS IN DOUBLE-INSULATED CASING



STRENGTHS

- 4-wire measurement
- Red "current" terminals
- Black "voltage" terminals

	References
1 A	P01165221
5 A	P01165222
10 A	P01165223
20 A	P01165224
30 A	P01165225

CONTENTS

- Shunt delivered with a user manual only

**IEC/EN6110-1 - 150 V CAT II - Pol 2
50 V CAT III**



3 A ~
30 A ~
300 A ~
3000 A ~
OFF



OL
Auto Power Off.
On

3 A ~ : 1 mV ~ / mA ~
30 A ~ : 100 mV ~ / A ~
300 A ~ : 10 mV ~ / A ~
3000 A ~ : 1 mV ~ / A ~



MA 110
AC CURRENT PROBE

600 V CAT IV
1000 V CAT III

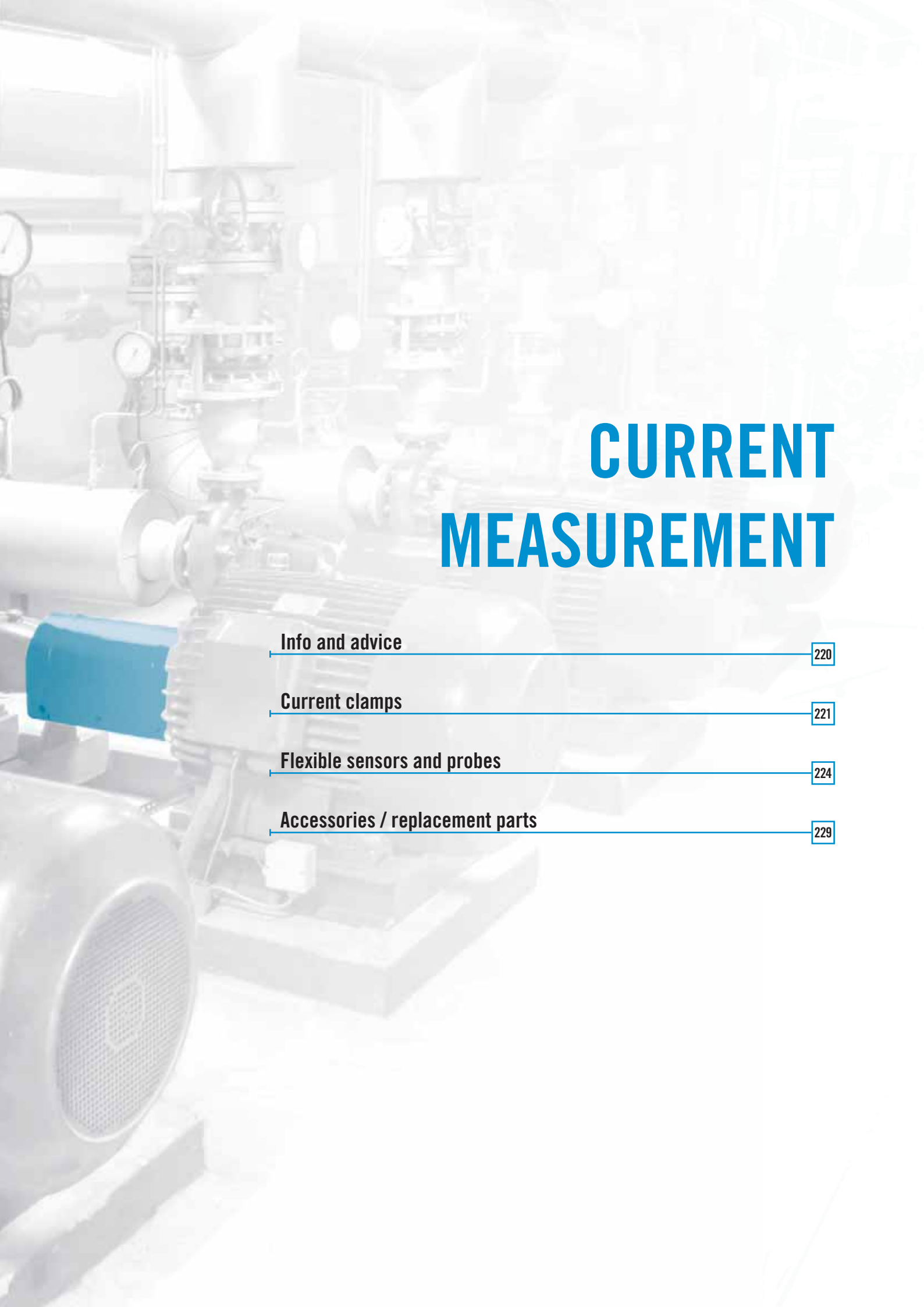

The background of the page is a faded, light-colored image of industrial machinery, including pipes, valves, and large cylindrical components, typical of a factory or power plant setting.

CURRENT MEASUREMENT

Info and advice

220

Current clamps

221

Flexible sensors and probes

224

Accessories / replacement parts

229



CHOOSING YOUR CURRENT CLAMP

There is a wide range of criteria for choosing a current clamp. The approach below is designed to help define your requirements and guide you naturally towards the model which best suits your application. The criteria selected are classified from 1 to 6.

To choose your clamp, we advise you to follow this logic:

- Measurement of direct or alternating current?
 - ➔ AC/DC clamps table or AC clamps table
- High or low currents?
 - ➔ see the “Input” column to define the appropriate families of clamps
- On small wires or large cables?
 - ➔ see the diagrams at the bottom of the next page and only choose families with the shapes and dimensions required
- What instrument will it be connected to?
 - ➔ see “Output / Connection” column to choose a clamp with compatible signal and connection possibilities
- What are your other criteria?
 - ➔ see “Specific features” column to check that the clamp chosen fulfils your requirements perfectly



THE WIDEST RANGE OF IEC 61010-2-032 CLAMPS

Our innovation, technical expertise and determination to manufacture top-quality products that comply with standards have made Chauvin Arnoux the worldwide specialist in current clamps.

On the next pages, you will find a table presenting the clamps for measuring AC/DC current, followed by a diagram giving the clamp form with dimensions and then another table grouping a large number of models for AC current.

As a result of their specifications, certain clamps are specialized for specific applications:

- Clamps for oscilloscopes (BNC output): E3N, PAC12, PAC22, MN60, Y7N, C160, D38N and MA200
- Clamps for leakage currents: MN73, C173 and B102
- Process current clamps: K1 and K2
- Clamp for measurement on the secondary windings of current transformers: MN71



As well as these standard specialized and unspecialized models, “specific” versions can also be produced on request: please ask for details.



	MINI	MN	YN	C1XX	DN	BXX	MiniFlex® MA110 Series	MiniFlex® MA130 Series	MiniFlex® MA200 Series	AmpFlex® A110 Series	AmpFlex® A130 Series	K	EN	PAC 1X	PAC 2X
	page 222	page 222	page 222	page 222	page 222	page 222	page 224	page 224	page 224	page 226	page 226	page 223	page 223	page 223	page 223

For current

Clamping \varnothing (mm)	10	20	30	52	64	115	45 70 100	70	45 70 100	140 250 380	250	3,9	8	30	42
AC	■	■	■	■	■	■	■	■	■	■	■	■	■	■	■
DC												■	■	■	■
Min	5 mA	10 mA	1 A	1 mA	100 mA	500 μ A	80 mA	500 mA	500 mA	80 mA	500 mA	100 μ A	5 mA	200 mA	200 mA
MAX	150 A	240 A	600 A	1200 A	3600 A	400 A	3000 A	3000 A	3000 A	30000 A	3000 A	4,5 A	150 A	600 A	1000 A

Output

in mA _{AC}	■	■	■	■	■										
in mV _{AC}	■	■	■	■	■	■	■	■	■	■	■				
in mV _{DC}	■	■	■												
in mV _{AC+DC}												■	■	■	■

Connections

Insulated \varnothing 4 mm sockets		■		■	■										
Lead with insulated elbowed \varnothing 4 mm male plugs	■	■	■	■	■	■	■			■			■	■	■
Insulated \varnothing 4 mm plug box with standard 19 mm spacing												■			
Coaxial cable with insulated male BNC		■	■	■	■			■	■		■		■	■	■

Single-calibre	■	■	■	■	■				■					■	■
Multi-calibre	■	■		■	■	■	■	■	■	■	■	■	■	■	■

For multimeters	■	■	■	■	■	■	■	■		■	■	■	■	■	■
For oscilloscopes		■	■	■	■				■				■	■	■
For detecting leaks and insulation faults		■		■		■									
For measuring power values, harmonics, etc.	■	■		■	■		■	■		■	■		■	■	■
For the process and the 4-20/0-20 mA measurement loop												■			

Power supply

Self-contained	■	■	■	■	■	■									
9 V battery							■	■	■	■	■	■	■	■	■
Mains adapter							■	■	■	■	■	■	■	■	■



CURRENT MEASUREMENT

AC CURRENT MEASUREMENT

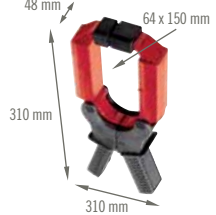
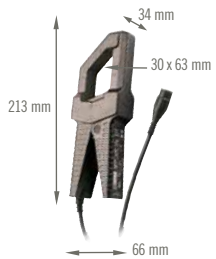
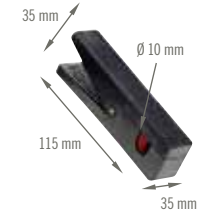

Series	Model	Input Measurement range ⁽¹⁾					Output - Connections			Specific features					Reference				
		Very low current	Low current	Medium current	High current	Alternating current	Direct current	Current	Voltage	Lead + safety plugs Ø 4 mm	Female sockets Ø 4 mm	BNC connector (optional)	Transformation ratio (input/output)	Output protected against overvoltages		Automatic DC zero	Power measurement (low phase shift)	Bandwidth (frequency in Hz)	Typical accuracy
MINI	MINI 01		2 to 150 A				0.15 A _{ac}					1,000/1				48 Hz...500 Hz	≤ 2.5%	P01105101Z	
	MINI 02	50 mA to 100 A					0.15 A _{ac}					1,000/1				48 Hz...10 kHz	≤ 1%	P01105102Z	
	MINI 03		1 to 100 A					0.1 V _{ac}				1 A / 1 mV					≤ 2%	P01105103Z	
	MINI 05	5 mA to 10 A	1 to 100 A					10 V _{ac}				1 mA / 1 mV				48 Hz...500 Hz	≤ 3%	P01105105Z	
	MINI 09		1 to 150 A					15 V _{dc} ⁽²⁾				1 A / 100 mV					≤ 4%	P01105109Z	
MN	MN08		0.5 to 240 A				0.2 A _{ac}					1,000/1				40 Hz...10 kHz	≤ 1%	P01120401	
	MN09		0.5 to 240 A				0.2 A _{ac}					1,000/1					≤ 1%	P01120402	
	MN10		0.5 to 240 A				0.2 A _{ac}					1,000/1					≤ 2%	P01120403	
	MN11		0.5 to 240 A				0.2 A _{ac}					1,000/1					≤ 2%	P01120404	
	MN12		0.5 to 240 A					2 V _{ac}				1 A / 10 mV					≤ 1%	P01120405	
	MN13		0.5 A to 240 A					2 V _{ac}				1 A / 10 mV					≤ 1%	P01120406	
	MN14		0.5 A to 240 A					0.2 V _{ac}				1 A / 1 mV					≤ 1%	P01120416	
	MN15		0.5 A to 240 A					0.2 V _{ac}				1 A / 1 mV					≤ 1%	P01120417	
	MN21		0.1 A to 240 A				0.2 A _{ac}					1,000/1					≤ 2%	P01120418	
	MN23		0.1 A to 240 A					2 V _{ac}				1 A / 10 mV					≤ 1.5%	P01120419	
	MN38		0.1 A to 24 A	0.5 A to 240 A				2 V _{ac}	2 V _{ac}			1 A / 100 mV	1 A / 10 mV				≤ 1%	P01120407	
	MN39		0.1 A to 24 A	0.5 A to 240 A				2 V _{ac}	2 V _{ac}			1 A / 100 mV	1 A / 10 mV				≤ 1%	P01120408	
	MN60		0.1 A to 60 A _{peak}	0.5 A to 600 A _{peak}				6 V _{peak}	6 V _{peak}			1 A / 100 mV	1 A / 10 mV				40 Hz...40 kHz	≤ 2%	P01120409
	MN71		10 mA to 12 A					1 V _{ac}				1 A / 100 mV					≤ 1%	P01120420	
MN73		10 mA to 2.4 A	100 mA to 240 A				2 V _{ac}	2 V _{ac}			1 mA / 1 mV	1 A / 10 mV			40 Hz...10 kHz	≤ 1%	P01120421		
MN88		0.5 A to 240 A					20 V _{dc} ⁽²⁾				1 A / 100 mV				≤ 2%	P01120410			
MN89		0.5 A to 240 A					20 V _{dc} ⁽²⁾				1 A / 100 mV				≤ 2%	P01120415			
Y	Y1N		4 A to 500 A				0.5 A _{ac}					1,000/1				48 Hz...1 kHz	≤ 3%	P01120001A	
	Y2N		4 A to 500 A				0.5 A _{ac}					1,000/1				≤ 1%	P01120028A		
	Y3N		4 A to 500 A				5 A _{ac}					100/1				≤ 3%	P01120029A		
	Y4N		4 A to 500 A					0.5 V _{dc} ⁽²⁾				500 A / 0.5 V				≤ 1%	P01120005A		
	Y7N		1 A to 1,200 A _{peak}									1 A / 1 mV			5 Hz...10 kHz	≤ 2%	P01120075		
	C100		0.1 A to 1,200 A				1 A _{ac}					1,000/1				≤ 0.5%	P01120301		
	C102		0.1 A to 1,200 A				1 A _{ac}					1,000/1				≤ 0.5%	P01120302		
C103		0.1 A to 1,200 A				1 A _{ac}					1,000/1				≤ 0.5%	P01120303			
C106		0.1 A to 1,200 A					1 V _{ac}				1 A / 1 mV				≤ 0.5%	P01120304			
C107		0.1 A to 1,200 A					1 V _{ac}				1 A / 1 mV				≤ 0.5%	P01120305			
C112		1 mA to 1,200 A				1 A _{ac}					1,000/1			30 Hz...10 kHz	≤ 0.3%	P01120314			
C113		1 mA to 1,200 A				1 A _{ac}					1,000/1				≤ 0.3%	P01120315			
C116		1 mA to 1,200 A					1 V _{ac}				1 A / 1 mV				≤ 0.3%	P01120316			
C117		1 mA to 1,200 A					1 V _{ac}				1 A / 1 mV				≤ 0.3%	P01120317			
C122		1 A to 1,200 A				5 A _{ac}					1,000/5				≤ 1%	P01120306			
C148		1 A to 300 A	1 A to 600 A	1 A to 1,200 A		5 A _{ac}					250/5	500/5	1,000/5		48 Hz...1 kHz	≤ 2%	P01120307		
C160		0.1 A to 30 A _{peak}	0.1 A to 300 A _{peak}	1 A to 2,000 A _{peak}			3 V _{peak}	3 V _{peak}	2 V _{peak}		10 A / 1 V	100 A / 1 V	1,000 A / 1 V		10 Hz...100 kHz	≤ 3%	P01120308		
C173		1 mA to 1.2 A	0.01 A to 12 A	0.1 A to 120 A	1 A to 1,200 A		1 V _{ac}				1 A / 1 V	10 A / 1 V	100 A / 1 V	1,000 A / 1 V	10 Hz...3 kHz	≤ 0.7%	P01120309		
B102		500 µA to 4 A	0.5 A to 400 A				4 V _{ac}	0.4 V _{ac}				1 mA / 1 mV	1 A / 1 mV		10 Hz...1 kHz	≤ 0.5%	P01120083		
D30N			1 A to 3,600 A			1 A _{ac}						3,000/1			30 Hz...5 kHz	≤ 0.5%	P01120049A		
D30CN			1 A to 3,600 A			1 A _{ac}						3,000/1			≤ 0.5%	P01120064			
D31N			1 A to 600 A	1 A to 1,200 A	1 A to 1,800 A	1 A _{ac}					500/1	1,000/1	1,500/1		30 Hz...1.5 kHz	≤ 3%	P01120050A		
D32N			1 A to 1,200 A	1 A to 2,400 A	1 A to 3,600 A	1 A _{ac}					1,000/1	2,000/1	3,000/1		30 Hz...1 kHz	≤ 1%	P01120051A		
D33N			1 A to 3,600 A			5 A _{ac}					3,000/5				30 Hz...5 kHz	≤ 1%	P01120052A		
D34N			1 A to 600 A	1 A to 1,200 A	1 A to 1,800 A	5 A _{ac}					500/5	1,000/5	1,500/5		30 Hz...1.5 kHz	≤ 3%	P01120053A		
D35N			1 A to 1,200 A	1 A to 2,400 A	1 A to 3,600 A	5 A _{ac}					1,000/5	2,000/5	3,000/5		30 Hz...1.5 kHz	≤ 1%	P01120054A		
D36N			1 A to 3,600 A			3 A _{ac}					3,000/3				≤ 0.5%	P01120055A			
D37N			0.1 A to 36 A	1 A to 360 A	1 A to 3,600 A		3 V _{ac}				30 A / 3 V	300 A / 3 V	3,000 A / 3 V		30 Hz...5 kHz	≤ 2%	P01120056A		
D38N			1 A to 90 A _{peak}	1 A to 900 A _{peak}	1 A to 9,000 A _{peak}		0.9 V _{peak}				1 A / 10 mV	1 A / 1 mV	1 A / 0.1 mV		30 Hz...50 kHz	≤ 2%	P01120057A		

(1) The upper value corresponds to 120 % of the max. rated value. (2) Reshaping of AC signal by diodes.

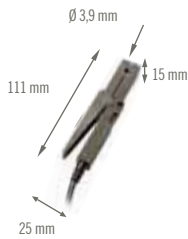

Series	Model	Input					Output - Connections			Specific features					Reference			
		Measurement range(1)					Current	Voltage	Lead + safety plugs ø 4 mm	Female sockets ø 4 mm	BNC connector (coaxial)	Transformation ratio (input/output)	Output protected against overvoltages	Automatic DC zero		Power measurement (low phase shift)	Bandwidth (frequency in Hz)	Typical accuracy
K	K1	Very low current 1 mA to 4.5 Acc 1 mA to 3 A RMS 1 mA to 4.5 Apeak	Low current	Medium current	High current	Alternating current	Direct current	4.5 V _{ac} 3 V _{rms} 4.5 V _{peak}	(2)			1 mA / 1 mV				DC...2 kHz	≤ 1%	P01120067A
	K2	100 µA to 450 mAcc 100 µA to 300 mRMS 100 µA to 450 mApeak						4.5 V _{ac} 3 V _{rms} 4.5 V _{peak}	(2)			1 mA / 10 mV				DC...1.5 kHz	≤ 1%	P01120074A
E	E1N		0.05 A to 2 Acc 0.05 A to 1.5 Acc 0.5 A to 150 Acc/dc					2 V _{dc} 1.5 V _{ac} 150 mV AC/DC				1 A / 1 V 1 A / 1 mV			DC... 2 kHz DC... 8 kHz	≤ 2% ≤ 1.5%	P01120030A	
	E3N		0.05 A to 10 A _{peak} 0.05 A to 10 Acc 1 A to 100 A _{peak} 1 A to 100 Acc					1 V _{peak} or DC				1 A / 100 mV 1 A / 10 mV			DC...100 kHz	≤ 3% ≤ 4%	P01120043A	
	E6N		5 mA to 2 Acc 5 mA to 1.5 Acc 20 mA to 80 Acc/dc					2 V _{dc} 1.5 V _{ac} 0.8 V _{ac/dc}				1 A / 1 V 1 A / 10 mV			DC... 2 kHz DC... 8 kHz	≤ 2% ≤ 4%	P01120040A	
PAC	PAC10		0.5 A to 400 Acc 0.5 A to 600 Acc					600 mV _{ac/dc}				1 A / 1 mV			DC...5 kHz	≤ 2%	P01120070	
	PAC11		0.2 A to 40 Acc 0.4 A to 60 Acc 0.5 A to 400 Acc 0.5 A to 600 Acc					600 mV _{ac/dc}				1 A / 10 mV 1 A / 1 mV			DC...10 kHz	≤ 1.5% ≤ 2%	P01120068	
	PAC12		0.2 A to 60 A _{peak} 0.4 A to 60 Acc 0.5 A to 600 A _{peak} 0.5 A to 600 Acc					600 mV _{peak} or DC				1 A / 10 mV 1 A / 1 mV			DC...10 kHz	≤ 1.5% ≤ 2%	P01120072	
PAC	PAC20		0.5 A to 1,000 Acc 0.5 A to 1,400 Acc					1.4 V AC/DC				1 A / 1 mV			DC...5 kHz	≤ 2%	P01120071	
	PAC21		0.2 A to 100 Acc 0.4 A to 150 Acc 0.5 A to 1,000 Acc 0.5 A to 1,400 Acc					1.4 V _{ac/dc}				1 A / 10 mV 1 A / 1 mV			DC...10 kHz	≤ 1.5% ≤ 2.5%	P01120069	
	PAC22		0.2 A to 150 A _{peak} 0.4 A to 150 Acc 0.5 A to 1,400 A _{peak} 0.5 A to 1,400 Acc					1.5 V _{peak} or DC 1.4 V _{peak} or DC				1 A / 10 mV 1 A / 1 mV			DC...10 kHz	≤ 1.5% ≤ 2.5%	P01120073	

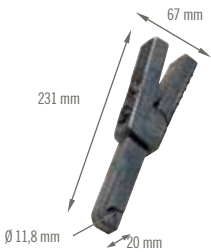

(1) The upper value corresponds to 120 % of the max. rated value. (2) Cable + electronic unit with ø 4 mm safety plugs and 19 mm spacing for the K Series



MA110 - MA130 - MA200

600 V CAT IV	1000 V CAT III	80 mA	3 kAac	4 calibres	IP 67
-----------------	-------------------	-------	--------	---------------	----------

STRENGTHS

- Flexible sensor comprising an active part (Rogowski coil) and a unit containing electronics
- For multimeters, loggers, oscilloscopes, etc.
- No magnetic saturation constraints: excellent linearity, low phase shift, wide dynamic range for measurement
- Flexibility of the sensors for easier clamping of the conductor to be measured
- Compact instruments which are easy to position in residential or industrial electrical cabinets
- Click system for opening and closing the core even when handling with safety gloves

ADDITIONAL INFO

MA110 model

- Measurement from 80 mA
- Can be connected to the AC voltage input (mVAC / VAC) of any multimeter or measuring instrument equipped with Ø 4 mm female banana plugs
- Can be powered by batteries or via a standard external power supply
- Equipped with an automatic power-off system which can be deactivated at start-up to perform long-duration measurement campaigns
- Possesses 3 LEDs (green, yellow and orange) indicating, respectively, the power-supply status, status of the automatic power-off function and measurement capacity overruns

Three-phase MA130 model

- Can be connected to the AC voltage inputs (mVAC / VAC) of any power analyser, logger or measuring instrument equipped with BNC plugs

Three-phase MA200 model



- Equipped with a BNC output and can be connected to all types of oscilloscopes
- Offers high bandwidth
- Particularly suitable for viewing transient signals, command signals, tripping currents of thyristors or the output signal from an electronic power supply

CONTENTS

- MA110 delivered with 2 x 1.5V LR6 alkaline batteries, 1 safety datasheet, 1 verification certificate
- MA130 with 2 x 1.5V LR6 alkaline batteries, 1 safety datasheet, 1 verification certificate, 1 set of coloured rings for cable foolproofing/identification, 3 female BNC / Ø 4 mm male plug adapters
- MA200 delivered with one 9 V battery, 1 verification certificate

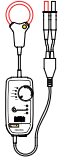
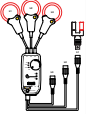

MiniFlex® FLEXIBLE PROBES FOR AC CURRENT

Series	Model	Input					Output - Connections			Specific features					Reference		
		Measurement range ⁽¹⁾					Current	Voltage	Lead + safety plugs ø 4 mm	Female sockets ø 4 mm	BNC connector (coaxial)	Transformation ratio (input/output)	Output protected against overvoltages	Automatic DC zero		Power measurement (low phase shift)	Bandwidth (frequency in Hz)
		Very low current	Low current	Medium current	High current	Alternating current	Direct current										
	MA110 3-30-300-3000/3 (17 cm / ø 4.5 cm)		0.08 A - 3 A 0.5 A .. 30 A 0.5 A .. 300 A 0.5 A .. 3,000 A					3 V _{AC}	(2)			1 V/A 100 mV/A 10 mV/A 1 mV/A			10 Hz .. 10 kHz 10 Hz .. 20 kHz 10 Hz .. 20 kHz 10 Hz .. 20 kHz	≤ 1%	P01120660
	MA110 3-30-300-3000/3 (25 cm / ø 7 cm)		0.08 A - 3 A 0.5 A .. 30 A 0.5 A .. 300 A 0.5 A .. 3,000 A					3 V _{AC}	(2)			1 V/A 100 mV/A 10 mV/A 1 mV/A			10 Hz .. 10 kHz 10 Hz .. 20 kHz 10 Hz .. 20 kHz 10 Hz .. 20 kHz	≤ 1%	P01120661
	MA110 3-30-300-3000/3 (35 cm / ø 10 cm)			0.08 A - 3 A 0.5 A .. 30 A 0.5 A .. 300 A 0.5 A .. 3,000 A					3 V _{AC}	(2)			1 V/A 100 mV/A 10 mV/A 1 mV/A			10 Hz .. 10 kHz 10 Hz .. 20 kHz 10 Hz .. 20 kHz 10 Hz .. 20 kHz	≤ 1%
	MA130 30-300-3000/3 (25 cm / ø 7 cm)		0.5 A .. 30 A 0.5 A .. 300 A 0.5 A .. 3,000 A					3 V _{AC}				100 mV/A 10 mV/A 1 mV/A			10 Hz .. 20 kHz 10 Hz .. 20 kHz 10 Hz .. 20 kHz	≤ 1%	P01120663
	MA200 30-300/3 (17 cm / ø 4.5 cm)		0.5 A .. 45 A _{PEAK} 0.5 A .. 450 A _{PEAK}					4.5 V _{PEAK}				100 mV/A 10 mV/A				≤ 1% + 0.3 A	P01120570
	MA200 30-300/3 (25 cm / ø 7 cm)		0.5 A .. 45 A _{PEAK} 0.5 A .. 450 A _{PEAK}					4.5 V _{PEAK}				100 mV/A 10 mV/A		5 Hz .. 1 MHz		≤ 1% + 0.3 A	P01120571
	MA200 3000 /3 (35 cm / ø 10 cm)		5 A .. 4,500 A _{PEAK}					4.5 V _{PEAK}				1 mV/A				≤ 1% + 0.3 A	P01120572

(1) The upper value corresponds to 120 % of the max. rated value. (2) Cable + electronic unit with ø 4 mm safety plugs and 19 mm spacing.



AmpFlex® FLEXIBLE PROBES FOR AC CURRENT

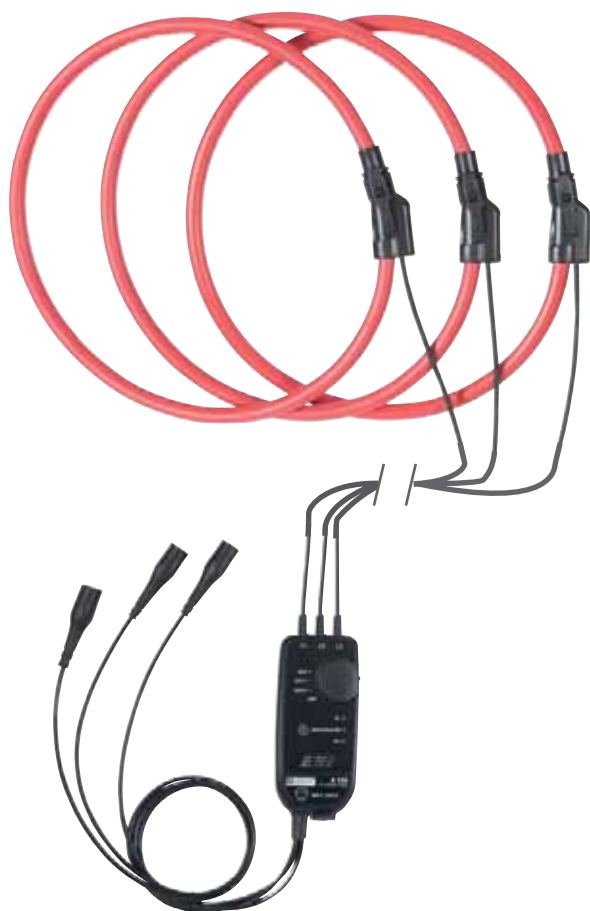

A110 - A130

1000 V CAT IV	80 mA	30 kA AC	IP 67	4 calibres
------------------	-------	----------	----------	---------------

STRENGTHS

- Flexible sensor comprising an active part (Rogowski coil) and a unit containing electronics
- For multimeters, loggers, oscilloscopes, etc.
- No magnetic saturation constraints: excellent linearity, low phase shift, wide dynamic range for measurement
- Flexibility of the sensors for easier clamping of the conductor to be measured
- Compact instruments which are easy to position in residential or industrial electrical cabinets
- Click system for opening and closing the core even when handling with safety gloves

ADDITIONAL INFO

A110 model

- Measures from 80 mA
- Can be connected to the AC voltage input (mVAC / VAC) of any multimeter or measuring instrument equipped with Ø 4 mm female banana plugs
- Can be powered by batteries or via a standard external power supply
- Equipped with an automatic power-off system which can be deactivated at start-up to perform long-duration measurement campaigns
- Possesses 3 LEDs (green, yellow and orange) indicating, respectively, the power-supply status, status of the automatic power-off function and measurement capacity overruns

Three-phase A130 model

- Can be connected to the AC voltage inputs (mVAC / VAC) of any power analyser, logger or measuring instrument equipped with BNC plugs



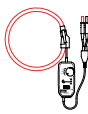
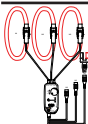

CONTENTS

- A110 delivered with 2 x 1.5V LR6 alkaline batteries, 1 safety datasheet, 1 verification certificate
- A130 delivered with 2 x 1.5V LR6 batteries, 1 datasheet, 1 verification certificate, 1 set of coloured rings for cable foolproofing/identification, 3 female BNC/Ø 4 mm male plug adapters

Series	Model	Input					Output - Connections				Specific features				Reference			
		Measurement range(1)					Current	Voltage	Lead + safety plugs Ø 4 mm	Female sockets Ø 4 mm	BNC connector (coaxial)	Transformation ratio (input/output)	Output protected against overvoltages	Automatic DC zero		Power measurement (low phase shift)	Bandwidth (frequency in Hz)	Typical accuracy
		Very low current	Low current	Medium current	High current	Alternating current	Direct current											
	A110 3-30-300-3,000/3 (45 cm / Ø 14 cm)		0.08 A - 3 A 0.5 A .. 30 A 0.5 A .. 300 A 0.5 A .. 3,000 A						3 V _{AC}	(2)			1 V/A 100 mV/A 10 mV/A 1 mV/A			10 Hz .. 10 kHz 10 Hz .. 20 kHz 10 Hz .. 20 kHz 10 Hz .. 20 kHz	≤ 1%	P01120630
	A110 3-30-300-3,000/3 (80 cm / Ø 25 cm)		0.08 A - 3 A 0.5 A .. 30 A 0.5 A .. 300 A 0.5 A .. 3,000 A						3 V _{AC}	(2)			1 V/A 100 mV/A 10 mV/A 1 mV/A			10 Hz .. 10 kHz 10 Hz .. 20 kHz 10 Hz .. 20 kHz 10 Hz .. 20 kHz	≤ 1%	P01120631
	A110 30-300-3000-3,000/3 (120 cm / Ø 38 cm)			0.5 A - 30 A 0.5 A .. 300 A 0.5 A .. 3,000 A 0.5 A .. 30,000 A						3 V _{AC}	(2)			100 mV/A 10 mV/A 1 mV/A 0.1 mV/A			10 Hz .. 5 kHz 10 Hz .. 20 kHz 10 Hz .. 20 kHz 10 Hz .. 20 kHz	≤ 1%
	A130 30-300-3,000/3 (80 cm / Ø 25 cm)		0.5 A .. 30 A 0.5 A .. 300 A 0.5 A .. 3,000 A						3 V _{AC}				100 mV/A 10 mV/A 1 mV/A			10 Hz .. 20 kHz 10 Hz .. 20 kHz 10 Hz .. 20 kHz	≤ 1%	P01120633

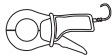
(1) The upper value corresponds to 120 % of the max. rated value. (2) Cable + electronic unit with Ø 4 mm safety plugs and 19 mm spacing.



Series	Model	Input						Output - Connections					Specific features					Reference
		Measurement range(1)						Current	Voltage	Lead + safety plugs \varnothing 4 mm	Female sockets \varnothing 4 mm	Female sockets \varnothing 4 mm	Transformation ratio (input/output)	Output protected against overvoltages	Automatic DC zero	Power measurement (low phase shift)	Bandwidth (frequency in Hz)	
LEAKAGE CURRENT MEASUREMENT																		
	MN73	10 mA to 24 A 100 mA to 240 A							2 Vac 2 Vac				1 A / 1,000 mV 1 A / 10 mV			40 Hz to 10 kHz	$\leq 1\%$ $\leq 2\%$	P01120421
	C173	1 mA to 12 A 0.01 A to 12 A 0.1 A to 120 A 1 A to 1,200 A							1 Vac				1 A / 1 V 10 A / 1 V 100 A / 1 V 1,000 A / 1 V			10 Hz to 3 kHz	$\leq 0.7\%$ $\leq 0.3\%$ $\leq 0.5\%$ $\leq 0.2\%$	P01120309
	B102	500 μ A to 4 A 0.5 A to 400 A							4 Vac 0.4 Vac				1 mA / 1 mV 1 A / 1 mV			10 Hz to 1 kHz	$\leq 0.5\%$ $\leq 0.35\%$	P01120083
PROCESS CURRENT MEASUREMENT																		
	K1	1 mA to 4.5 A _{DC} 1 mA to 3 A _{RMS} 1 mA to 4.5 A _{PEAK}					(2)		4.5 V _{DC} 3 V _{RMS} 4.5 V _{PEAK}				1 mA / 1 mV			DC to 2 kHz	$\leq 1\%$	P01120067A
	K2	100 μ A to 450 mA _{DC} 100 μ A to 300 mA _{RMS} 100 μ A to 450 mA _{PEAK}					(2)		4.5 V _{DC} 3 V _{RMS} 4.5 V _{PEAK}				1 mA / 10 mV			DC to 1.5 kHz	$\leq 1\%$	P01120074A
MEASUREMENT ON CURRENT TRANSFORMER SECONDARY																		
	MN71	10 mA to 12 A							1 Vac				1 A / 100 mV			40 Hz to 10 kHz	$\leq 1\%$	P01120420

(1) The upper value corresponds to 120 % of the max. rated value. (2) Cable + electronic unit with \varnothing 4 mm safety plugs and 19 mm spacing.

Please contact us for models with specific sensitivities (mV/A) and/or lengths. We can also supply bare sensors for integration into assemblies including the signal-processing electronics.



ADDITIONAL INFO

- View the currents in total safety without opening the circuit!
- Capture the signal simply by clamping the conductor

600 V
CAT III

IEC
61010-2-32

Series	Model	Input						Output - Connections			Specific features					Reference		
		Measurement range(1)						Current	Voltage	Lead + safety plugs ø 4 mm Female sockets ø 4 mm BNC connector (coaxial)	Transformation ratio (input/output)	Output protected against overvoltages	Automatic DC zero	Power measurement (low phase shift)	Bandwidth (frequency in Hz)		Typical accuracy	
Very low current	Low current	Medium current	High current	Alternating current	Direct current													
MEASUREMENT ON OSCILLOSCOPE																		
	MA60		0.1 A to 60 A _{PEAK} 0.5 A to 600 A _{PEAK}						6 V _{PEAK}			1 A / 100 mV 1 A / 10 mV				40 Hz to 40 kHz	≤ 2% ≤ 1.5%	P01120409
	Y7N		1 A to 1,200 A _{PEAK}						1.2 V _{PEAK}			1 mA / 1 mV				5 Hz to 10 kHz	≤ 2%	P01120075
	C160		0.1 A to 300 A _{PEAK} 1 A to 300 A _{PEAK} 1 A to 2,000 A _{PEAK}						3 V _{PEAK} 3 V _{PEAK} 2 V _{PEAK}			10 A / 1 V 100 A / 1 V 1,000 A / 1 V				10 Hz to 100 kHz	≤ 3% ≤ 2% ≤ 1%	P01120308
	D38N		1 A to 90 A _{PEAK} 1 A to 900 A _{PEAK} 1 A to 9,000 A _{PEAK}						0.9 V _{PEAK}			1 A / 10 V 1 A / 1 mV 1 A / 0.1 mV				30 Hz to 50 kHz	≤ 2%	P01120057A
	MA200 30-300/3 (17 cm)		0.5 A...45 A _{PEAK} 0.5 A...450 A _{PEAK}						4.5 V _{PEAK}			100 mV/A 10 mVA					≤ 1% + 0.3 A	P01120570
	MA200 30-300/3 (25 cm)		0.5 A...45 A _{PEAK}						4.5 V _{PEAK}			100 mV/A 10 mVA			5 Hz...1 MHz		≤ 1% + 0.3 A	P01120571
	MA200 3000/3 (35 cm)		5 A...4,500 A _{PEAK}						4.5 V _{PEAK}			1 mV/A					≤ 1% + 0.3 A	P01120572
	E3N		0.05 A to 10 A _{PEAK} 1 A to 100 A _{PEAK}						1 V _{PEAK}			1 A / 10 mV 1 A / 1 mV				DC to 10 kHz	≤ 3% ≤ 4%	P01120043A P01120047*
	PAC12		0.2 A to 60 A _{PEAK} 0.4 A to 60 A _{DC} 0.5 A to 600 A _{PEAK} 0.5 A to 600 A _{DC}						600 mV _{PEAK} ou DC			1 A / 10 mV 1 A / 1 mV				DC to 10 kHz	≤ 1.5% ≤ 2%	P01120072
	PAC22		0.2 A to 150 A _{PEAK} 0.4 A to 150 A _{DC} 0.5 A to 1,400 A _{PEAK} 0.5 A to 1,400 A _{DC}						1.5 V _{PEAK} 1.4 V _{PEAK}			1 A / 10 mV 1 A / 1 mV				DC to 10 kHz	≤ 1.5% ≤ 2.5%	P01120073

(1) The upper value corresponds to 120 % of the max. rated value.

*Reference for E3N + power supply > P01120047



ACCESSORIES / REPLACEMENT PARTS

FOR CURRENT SENSORS

MiniFlex® MA110/MA130 and AmpFlex® A110/A130

- Mains adapter / μ USB-B cable P01651023
- 110V-240V 50/60 Hz
- Female USB type A 5V 1A
- Charging and connection cable
- Male USB type A - male USB type Micro-B
- 1.80 m

MN73 / C173 / B102

- AN1 artificial neutral box P01197201

OTHER CURRENT SENSORS

- Mains adapter for E clamp P01101965
- Mains adapter for K clamp P01101966
- Mains adapter for PAC clamp P01101967
- Mains adapter for AmpFlex® A100 P01101968
- Mains adapter for MiniFlex® MA100 P01102986
- Mains adapter for MiniFlex® MA200 P01102987



AN1 artificial neutral box

FIND ALL OUR ACCESSORIES ON PAGE 230

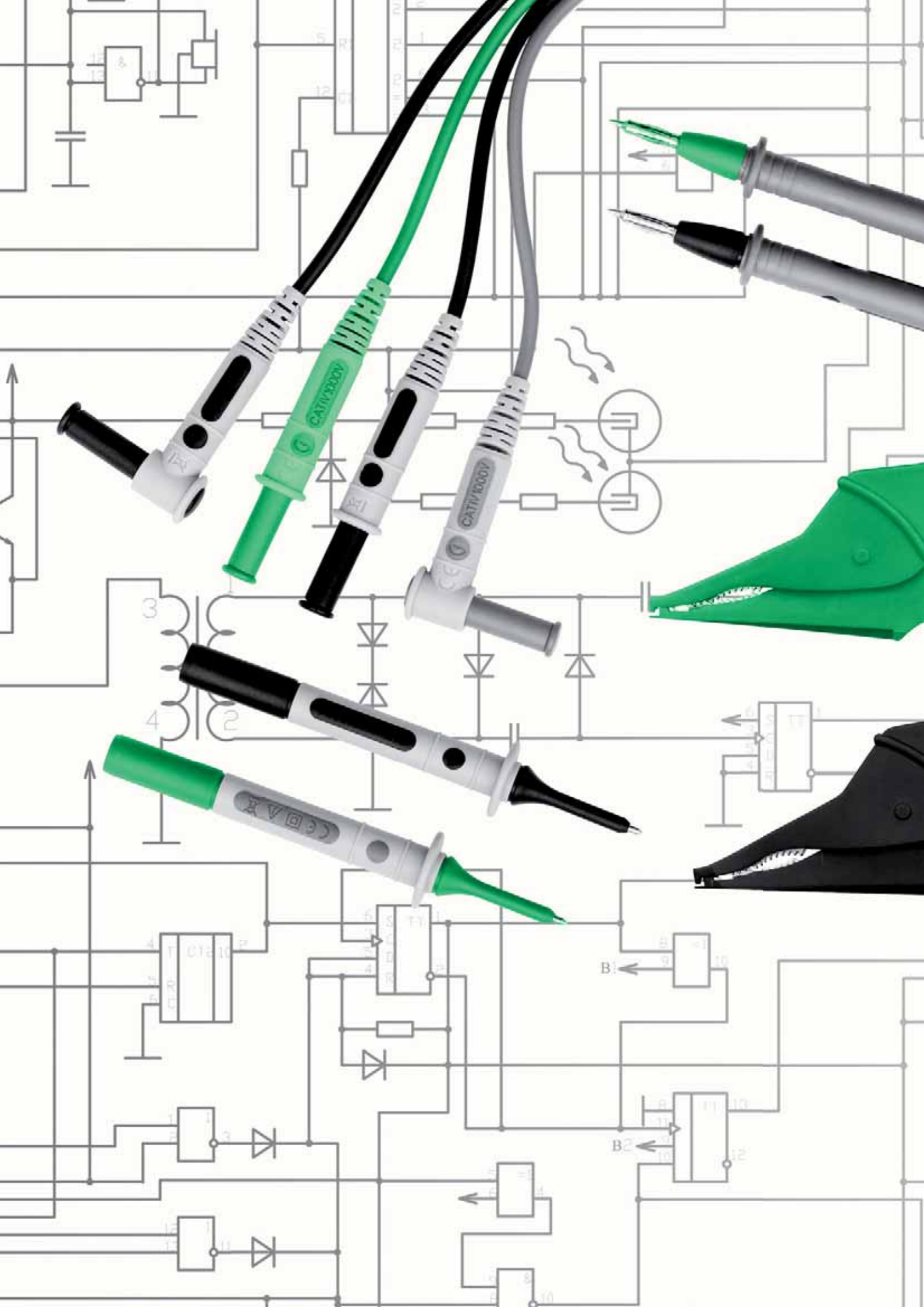



ACCESSORIES

Protection, storage and transport

232

Connections

238

Adapters and probes

242

Fuses

243



ACCESSORIES

PROTECTION, STORAGE & TRANSPORT

SOFT CASES



E01



E02



E03



E04



E05



E06



E07



E08

BAGS



S01



S02



S03



S04



S05



S06



S07



S08



S09



S10

SHOULDER BAGS



S20



S21



S22



S23

HARD CASES



M01-M02-M03



M04-M05-M06



M07

MOUNTING SUPPORT



F01

WATERPROOF SITE CASES



B01



B02



PROTECTION, STORAGE AND TRANSPORT

Photo	L x H x W	Reference	Additional information
SOFT CASE			
E01	110 x 220 x 45 mm	P01298065Z	
E02	125 x 210 x 120 mm	P01298049	Specific to one instrument or product range. See pages 234
E03	125 x 265 x 60 mm	P01298043Z	
E04	180 x 75 x 45 mm	P01298012	
E05	185 x 135 x 85 mm	P01298046	Specific to one instrument or product range. See pages 234
E06	190 x 250 x 60 mm	P01298055	
E07	250 x 190 x 80 mm	P01298051	
E08	70 x 185 x 30 mm	P01298007	
BAG			
S01	120 x 200 x 60 mm	P01298074	Compatible with MultiFix
S02	120 x 245 x 60 mm	P01298075	Compatible with MultiFix
S03	120 x 320 x 60 mm	P01298076	Compatible with MultiFix
S04	150 x 230 x (40+40) mm	P01298032	
S05	165 x 250 x 60 mm	P06239502	
S06	180 x 220 x 75 mm	P01298036	
S07	225 x 270 x 70 mm	P01298033	
S08	240 x 140 x 130 mm	P01298006	
S09	355 x 255 x 235 mm	P01298056	
S10	360 x 200 x 140 + 360 x 160 x 35 mm	P01298061A	
SHOULDER BAG			
S20	330 x 240 x 240 mm	P01298078	
S21	380 x 280 x 200 mm	P01298066	All-terrain waterproof bottom. 2 compartments and space for documents. Supplied with shoulder strap
S22	575 x 320 x (200 + x + x) mm	P01298067	
S23		P01298031	
HARD CASE			
M01	270 x 195 x 65 mm	P01298071	Equipped with foam inserts. Delivered with strap and keys
M02	285 x 210 x 80 mm	P01298037	Specific to one instrument or product range. See pages 234
M03	285 x 210 x 80 mm	P01298037A	Specific to one instrument or product range. See pages 234
M04	320 x 255 x 75 mm	P01298004	Equipped with foam inserts. Delivered with strap and keys
M05	320 x 255 x 75 mm	P01298011	Specific to one instrument or product range. See pages 234
M06	320 x 255 x 75 mm	P01298040	Specific to one instrument or product range. See pages 234
M07	440 x 310 x 135 mm	P01298072	Equipped with foam inserts. Delivered with strap and keys
WATERPROOF CASE			
B01	272 x 248 x 130 mm	P01298068	Equipped with foam inserts
B02	272 x 248 x 182 mm	P01298069	Equipped with foam inserts

MULTIFIX MOUNTING ACCESSORY

P01102100Z

When used with the compatible soft cases and bags, this helps you to transport and mount the measuring instruments for greater user comfort.



REELING BOX

P01102149

To make sure that your cables are never tangled. Can be used to store up to 3 m of cable (1 x 3 m / 2 x 1.5 m). Built-in magnet for easy mounting on any metal surface.



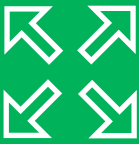

ACCESSORIES

CHOOSE THE RIGHT PROTECTION FOR YOUR INSTRUMENT

Photo no.	Code	Mounting acc.	Soft case								Bag					Bag			
		F01	E01	E02	E03	E04	E05	E06	E07	E08	S01	S02	S03	S04	S05	S06	S07	S08	S09
AL834		P01102100Z																	
AN1 artificial neutral box		P01298065Z																	
C.A 1052		P01298049																	
C.A 1621, C.A 1623, C.A 1631		P01298043Z																	
C.A 1725, C.A 1727		P01298012 P01298012Z																	
C.A 1864, C.A 1866		P01298046																	
C.A 1877, C.A 1878, C.A 1882		P01298055																	
C.A 40		P01298051																	
C.A 401, C.A 402, C.A 403, C.A 404, C.A 405, C.A 406, C.A 406 KIT		P01298007																	
C.A 41, C.A 43		P01298074																	
C.A 5001, C.A 5003, C.A 5005		P01298075																	
C.A 5005		P01298076																	
C.A 5011		P01298032																	
C.A 5030		P06239502																	
C.A 5110, C.A 5120		P01298036																	
C.A 5205G/10G/20G/30G/40G/60G		P01298033																	
C.A 5231, C.A 5233		P01298006																	
C.A 5271, C.A 5273, C.A 5275, C.A 5277		P01298056																	
C.A 5287, C.A 5289																			
C.A 6030																			
C.A 61, C.A 65																			
C.A 6113, C.A 6116, C.A 6116N, C.A 6117																			
C.A 6115N																			
C.A 6121																			
C.A 6160																			
C.A 6240, C.A 6250																			
C.A 6410, C.A 6411, C.A 6412, C.A 6413, C.A 6415																			
C.A 6416, C.A 6417																			
C.A 6421, C.A 6423																			
C.A 6425																			
C.A 6454, C.A 6456																			
C.A 6460, C.A 6462																			
C.A 6501, C.A 6503																			
C.A 6505																			
C.A 6511, C.A 6513																			
C.A 6521, C.A 6523, C.A 6525																			
C.A 6522/24/26, C.A 6532/34/36																			
C.A 6531, C.A 6533																			
C.A 6541, C.A 6543																			
C.A 6545, C.A 6547																			



CHOOSE THE RIGHT PROTECTION FOR YOUR INSTRUMENT

Sheath		Shockproof sheath				Hard case							Bag				Strap	
		M02	M03	M04	M05	M06	M02	M07	S20	S21	S22	S23						
P01298015																		
P0129809B																		
P01298016																		
P03298504																		
P01298037																		
P01298037A																		
P01298004																		
P01298011																		
P01298040																		
P01298080																		
P01298072																		
P01298078																		
P01298066																		
P01298067																		
P01298031																		
P01298057																		
P01298005																		

Photo no.

Code

- AL834
- AN1 artificial neutral box
- C.A 1052
- C.A 1621, C.A 1623, C.A 1631
- C.A 1725, C.A 1727
- C.A 1864, C.A 1866
- C.A 1877, C.A 1878, C.A 1882
- C.A 40
- C.A 401, C.A 402, C.A 403, C.A 404, C.A 405, C.A 406, C.A 406 KIT
- C.A 41, C.A 43
- C.A 5001, C.A 5003, C.A 5005
- C.A 5005
- C.A 5011
- C.A 5030
- C.A 5110, C.A 5120
- C.A 52056/106/206/306/406/606
- C.A 5231, C.A 5233
- C.A 5271, C.A 5273, C.A 5275, C.A 5277
- C.A 5287, C.A 5289
- C.A 6030
- C.A 61, C.A 65
- C.A 6113, C.A 6116, C.A 6116N, C.A 6117
- C.A 6115N
- C.A 6121
- C.A 6160
- C.A 6240, C.A 6250
- C.A 6410, C.A 6411, C.A 6412, C.A 6413, C.A 6415
- C.A 6416, C.A 6417
- C.A 6421, C.A 6423
- C.A 6425
- C.A 6454, C.A 6456
- C.A 6460, C.A 6462
- C.A 6501, C.A 6503
- C.A 6505
- C.A 6511, C.A 6513
- C.A 6521, C.A 6523, C.A 6525
- C.A 6522/24/26, C.A 6532/34/36
- C.A 6531, C.A 6533
- C.A 6541, C.A 6543
- C.A 6545, C.A 6547



ACCESSORIES

CHOOSE THE RIGHT PROTECTION FOR YOUR INSTRUMENT

Photo no.	Mounting acc.	Soft case								Bag					Bag			
	F01	E01	E02	E03	E04	E05	E06	E07	E08	S01	S02	S03	S04	S05	S06	S07	S08	S09
Code	P01102100Z	P01298065Z	P01298049	P01298043Z	P01298012 P0129801ZZ	P01298046	P01298055	P01298051	P01298007	P01298074	P01298075	P01298076	P01298032	P06239502	P01298036	P01298033	P01298006	P01298056
C.A 6550, C.A 6555																		
C.A 702, C.A 703																		
C.A 704																		
C.A 730, C.A 735																		
C.A 745																		
C.A 740, C.A 760, C.A 740N, C.A 740N IP2X, C.A 760N, C.A 760N IP2X																		
C.A 742, C.A 742 IP2X, C.A 762, C.A 762 IP2X																		
C.A 745N, C.A 755, C.A 757																		
C.A 771, C.A 771 IP2X, C.A 773, C.A 773 IP2X																		
C.A 8220, C.A 8230																		
C.A 8331, C.A 8332, C.A 8333, C.A 8334, C.A 8335, C.A 8336																		
C.A 8352																		
C.A 8435																		
C.A 871, C.A 879																		
CADI 2																		
CDA 104																		
DTR 8510																		
F01, F03, F05, F07, F09																		
F11N, F13N, F15																		
F201, F203, F205																		
F21																		
F3N																		
F401, F403, F405, F407																		
F601, F603, F605, F607																		
F62, F65																		
FTV200																		
L101, L102, L111, L261, L322, L481, L562, L642, ML912																		
L452																		
MA400D, MA4000D																		
MAN'X 015, MAN'X 02S																		
MAN'X TOP, MAN'X TOP PLUS																		
MAX 2000, MAX 3000																		
PAC10, PAC11, PAC12																		
PAC20, PAC21, PAC22																		
PEL102, PEL103																		
PEL105																		
RW501, RW511, RW521, RW5012																		
SIMPLE LOGGER ML914, AL834																		
TK 1000																		
TP 850																		



CHOOSE THE RIGHT PROTECTION FOR YOUR INSTRUMENT

Sheath		Shockproof sheath		Hard case							Bag				Strap		Photo no.
P01298015	P01298098	P01298016	P03298504	M02	M03	M04	M05	M06	M02	M07	S20	S21	S22	S23	P01298057	P01298005	Code
																	C.A 6550, C.A 6555
																	C.A 702, C.A 703
																	C.A 704
																	C.A 730, C.A 735
																	C.A 745
																	C.A 740, C.A 760, C.A 740N, C.A 740N IP2X, C.A 760N, C.A 760N IP2X
																	C.A 742, C.A 742 IP2X, C.A 762, C.A 762 IP2X
																	C.A 745N, C.A 755, C.A 757
																	C.A 771, C.A 771 IP2X, C.A 773, C.A 773 IP2X
																	C.A 8220, C.A 8230
																	C.A 8331, C.A 8332, C.A 8333, C.A 8334, C.A 8335, C.A 8336
																	C.A 8352
																	C.A 8435
																	C.A 871, C.A 879
																	CADI 2
																	CDA 104
																	DTR 8510
																	F01, F03, F05, F07, F09
																	F11N, F13N, F15
																	F201, F203, F205
																	F21
																	F3N
																	F401, F403, F405, F407
																	F601, F603, F605, F607
																	F62, F65
																	FTV200
																	L101, L102, L111, L261, L322, L481, L562, L642, ML912
																	L452
																	MA400D, MA4000D
																	MAN'X 015, MAN'X 02S
																	MAN'X TOP, MAN'X TOP PLUS
																	MAX 2000, MAX 3000
																	PAC10, PAC11, PAC12
																	PAC20, PAC21, PAC22
																	PEL102, PEL103
																	PEL105
																	RW501, RW511, RW521, RW5012
																	SIMPLE LOGGER ML914, AL834
																	TK 1000
																	TP 850







ACCESSORIES

Ø 4 MM BANANA CONNECTION TECHNOLOGY



MEASUREMENT LEADS

Moulded

Model	Description
	Set of 2 red/black moulded PVC leads P01295450Z Insulated straight male plug Ø 4 mm Insulated straight male plug Ø 4 mm • 15 A • 1.5 m • 1000 V CAT IV
	Set of 2 red/black moulded silicone leads P01295452Z Insulated straight male plug Ø 4 mm Insulated straight male plug Ø 4 mm • 15 A • 1.5 m • 1000 V CAT IV

Model	Description
	Set of 2 red/black moulded PVC leads P01295451Z Insulated straight male plug Ø 4 mm Insulated elbowed male plug Ø 4 mm • 15 A • 1.5 m • 1000 V CAT IV
	Set of 2 red/black moulded silicone leads P01295453Z Insulated straight male plug Ø 4 mm Insulated elbowed male plug Ø 4 mm • 15 A • 1.5 m • 1000 V CAT IV



Standards

Model	Description
	Set of 2 red/black PVC leads P01295288Z Insulated straight male plug Ø 4 mm Insulated straight male plug Ø 4 mm • 15 A • 1.5 m • 600 V CAT IV / 1000 V CAT III
	Set of 2 red/black PVC leads P01295290Z Insulated straight male plug Ø 4 mm with rear connection. Insulated straight male plug Ø 4 mm with rear connection • 20 A • 2 m • 600 V CAT III

Model	Description
	Set of 2 red/black PVC leads P01295289Z Insulated straight male plug Ø 4 mm Insulated elbowed male plug Ø 4 mm • 15 A • 1.5 m • 600 V CAT IV / 1000 V CAT III

LEADS WITH TEST PROBES

For CAT IV & CAT III installations

Model	Description
	Set of 2 red/black PVC test-probe leads P01295455Z Insulated straight male plug Ø 4 mm • 15 A • 1.5 m • 600 V CAT IV / 1000 V CAT III
	Set of 2 IP2X PVC leads for multimeters P01295461Z Complies with NF C 18-510 and IEC 61010-031+A1:2008 • IP2X test probe • Insulated elbowed male plug Ø 4 mm • 15 A • 1.5 m • 600 V CAT IV

Model	Description
	Set of 2 red/black PVC test-probe leads P01295456Z Insulated elbowed male plug Ø 4 mm • 15 A • 1.5 m • 600 V CAT IV / 1000 V CAT III



Ø 4 MM BANANA CONNECTION TECHNOLOGY

LEADS WITH TEST PROBES

For CAT II & lower installations

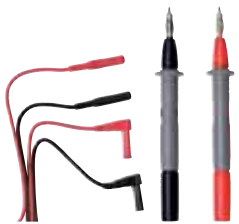
Model	Description
	Measurement leads + test probes kit P01295475Z comprising: Set of 2 red/black PVC leads Insulated straight male plug Ø 4 mm Insulated elbowed male plug Ø 4 mm • 15 A • 1.5 m • 600 V CAT IV / 1000 V CAT III + Set of 2 moulded test probes Ø 4 mm • Female plug Ø 4 mm • CAT II 300 V

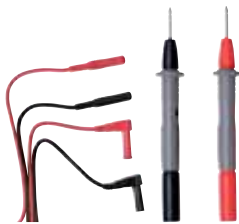
Model	Description
	Measurement leads + test probes kit P01295474Z comprising: Set of 2 red/black PVC leads Insulated straight male plug Ø 4 mm Insulated elbowed male plug Ø 4 mm • 15 A • 1.5 m • 600 V CAT IV / 1000 V CAT III + Set of 2 moulded test probes Ø 2 mm • Female plug Ø 4 mm • CAT II 300 V

REMOVABLE TEST PROBES

For CAT IV & CAT III installations

Model	Description
	Set of 2 red/black moulded test probes P01295454Z • Female plug Ø 4 mm • 15 A • CAT IV / CAT III 1000 V

For CAT II & lower installations

Model	Description
	Set of 2 moulded test probes Ø 4 mm P01295458Z • Female plug Ø 4 mm • 15 A • CAT II 300 V

Model	Description
	Set of 2 moulded test probes Ø 2 mm P01295460Z • Female plug Ø 4 mm • 15 A • CAT II 300 V



ACCESSORIES

PRODUCT-SPECIFIC ACCESSORIES



FOR MULTIMETERS OR TESTERS WITH + TERMINAL ON TOP

Model	Description
	Red test probe Ø 4 mm P01103060Z removable for tester or DMM Use as "hands-free" test probe <ul style="list-style-type: none"> • Male plug Ø 4 mm • 600 V CAT IV



FOR C.A 745 TESTER OR REMOTE-CONTROL PROBE

Model	Description
	Red test probe Ø 4 mm P01103061Z removable with locking pin For tester or remote-control probe <ul style="list-style-type: none"> • Male plug Ø 4 mm • 600 V CAT IV



FOR C.A 704, C.A 740 & C.A 760 VOLTAGE ABSENCE TESTERS

Model	Description
	Removable red test probe P01103059Z <ul style="list-style-type: none"> • Female plug Ø 4 mm • 600 V CAT IV
	Black test-probe lead P01295464Z Insulated elbowed female plug Ø 4 mm Length 0.85 m <ul style="list-style-type: none"> • 600 V CAT IV

FOR C.A 745N, C.A 755 AND C.A 757



Model	Description
	Set of red/black test probes P01102152Z <ul style="list-style-type: none"> • CAT III/IV
	Set of red/black test probes P01102153Z <ul style="list-style-type: none"> • Ø 2 mm • CAT II
	Set of red/black test probes P01102154Z <ul style="list-style-type: none"> • Ø 4 mm • CAT II



FOR ALL VOLTAGE ABSENCE TESTERS, C.A 74X/XN SERIES / C.A 76X/XN SERIES

Model	Description
	Set of 2 PVC IP2X leads P01295463Z for C.A 760 and C.A 704 VATs Complies with NF C 18-510 and IEC 61010-031+A1:2008 <ul style="list-style-type: none"> • IP2X test probe Ø 2 mm • Elbowed female plug Ø 4 mm • 15 A • 1.5 m • 600 V CAT IV
	Red removable test probe P01102008Z <ul style="list-style-type: none"> • Female plug Ø 4 mm • IEC 61243-3
	Black test-probe lead P01102009Z Insulated elbowed female plug Ø 4 mm Length 0.85 m <ul style="list-style-type: none"> • IEC 61243-3

Model	Description
	Set of 2 IP2X leads for C.A 740N and C.A 760N VATs P01295462Z <ul style="list-style-type: none"> • IP2X test probe Ø 4 mm • Elbowed female plug Ø 4 mm • 15 A • NF C 18-510 / IEC 61243-3 1000 V • 1.5 m
	Set of IP2X accessories for VAT P01102121Z <ul style="list-style-type: none"> • 2 x IP2X Ø 4 mm test probes • 1 point-point cable, L = 1.10 m
	C.A 751 measurement adapter P01101997Z <ul style="list-style-type: none"> • For 2P+E sockets









FOR C.A 771 & C.A 773 VOLTAGE ABSENCE TESTERS

Model	Description
	Set of 2 red/black IP2X test probes Ø 4 mm P01102128Z Female plug Ø 4 mm IEC 61423-3 1000 V
	Set of 2 red/black IP2X test probes P01102127Z Female plug Ø 4 mm 1000 V CAT IV
	Set of 2 red/black test probes P01102123Z Female plug Ø 4 mm 1000 V CAT IV

Model	Description
	Set of 2 red/black test probes Ø 2 mm with crystal cap P01102124Z Female plug Ø 4 mm IEC 61423-3 1000 V
	Set of 2 red/black test probes Ø 4 mm P01102125Z Female plug Ø 4 mm IEC 61423-3 1000 V
	Crystal protective cap for test probe P01102126Z



FOR CAT IV & CAT III INSTALLATIONS

Model	Description	Model	Description
	Set of 2 red/black crocodile clips P01295457Z <ul style="list-style-type: none"> • 15 A • 1000 V CAT IV 		Set of 2 red/black crocodile wire grips P01102053Z <ul style="list-style-type: none"> • 20 A • 1000 V CAT III
	Set of leads and measuring accessories for electricians P01295459Z <ul style="list-style-type: none"> • 2 x 1000 V CAT IV moulded test probes • 2 x 1.5 m 1000 V CAT IV red/black moulded leads with straight male plug – elbowed male plug • 2 x red/black 1000 V CAT IV crocodile clips • 2 x 300 V CAT II moulded test probes Ø 4 mm 		Set of 2 adapters P01102101Z Insulated female BNC plug – Red/black insulated male plugs Ø 4 mm with 19 mm spacing <ul style="list-style-type: none"> • 600 V CAT III
	Kit of 2 PVC leads + 2 test probes Ø4 mm P01295475Z <ul style="list-style-type: none"> • Straight male plug Ø4 mm - Elbowed male plug Ø4 mm • Probe Ø4 mm - Female plug Ø 4mm • 300 V CAT II 		Kit of 2 PVC leads + 2 test probes Ø2 mm P01295474Z <ul style="list-style-type: none"> • Straight male plug Ø4 mm - Elbowed male plug Ø4 mm • Probe Ø2 mm - Female plug Ø 4mm • 300 V CAT II
	Set of 2 red/black magnetized test probes P01103058Z For voltage measurement only Ø test probe: 6.6 mm – Elbowed female plug Ø 4 mm <ul style="list-style-type: none"> • 1000 V CAT III / 600 V CAT IV 		PVC lead AG-1066Z Insulated male BNC plug – Insulated straight male banana plugs Ø 4 mm (red/black) with rear connection <ul style="list-style-type: none"> • 1 m • 500 V CAT III

FOR CAT II & LOWER INSTALLATIONS

Model	Description	Model	Description
	Set of 3 measurement adapters for housing P01102114Z 2 red/black insulated straight male plugs Ø4 mm <ul style="list-style-type: none"> • E27 screw socket • B22 bayonet socket • 2-pole mains socket (P/N) • 250 V CAT II 		C.A 753: Measurement adapter for 2P+E socket P01191748Z <ul style="list-style-type: none"> • Suitable for European and Schuko sockets • Can be used for measurements on the P (Phase), N (Neutral) and PE (Earth) conductors in total safety • Guarantees mechanical and electrical contact with all test probes (Ø2, Ø4, IP2x, etc.) • Shows the presence of a P-N voltage (> 200 V) and indicates the phase position • IEC 61010 230 V CAT II
	Current lead equipped with a French 2P+E mains socket P03295509 <ul style="list-style-type: none"> • For inserting an ammeter in series in total safety • For measuring the current with a current clamp without having to remove the outer sheath of the power supply cable 		Measurement lead for French and German 2P+E mains sockets P06239307 For direct measurement on a mains socket Quick implementation and reliable connections
	Set of 2 red/black insulation-piercing clips P01102055Z <ul style="list-style-type: none"> • 30 V AC, 60 V DC 		CMS clamp HX0064 Copper-gold-plated beryllium contacts Output via male plugs Ø 4 mm <ul style="list-style-type: none"> • 1.2 m • SELV
	Set of 2 adapters P01101846 Red/black insulated male BNC – female sockets Ø 4 mm with 19 mm spacing <ul style="list-style-type: none"> • 500 V CAT I, 150 V CAT III 		Set of 2 adapters P01101847 Red/black insulated BNC male – male sockets Ø 4 mm with 19 mm spacing <ul style="list-style-type: none"> • 500 V CAT I, 150 V CAT III



ACCESSORIES

OTHER ACCESSORIES

FOR CAT II & LOWER INSTALLATIONS



Modèle	Description
	SHT40KV high-voltage probe for multimeters P01102097 Maximum rated voltage: 40 kVdc, 28 kVRMS or 40 kVPEAK (50/60 Hz) Division ratio (input/output : 1 kV / 1 V For multimeters with 10 MΩ input impedance



EXTERNAL POWER SUPPLY & MAINS POWER PACK

Model	Description
	Set of 4 x 1.5 V LR06 rechargeable batteries with low self-discharge plus charger HX0053
	Set of 4 x 1.5 V LR06 rechargeable batteries with low self-discharge HX0051B



Model	Description
	230 V / μUSB mains adapter – B P01651023 <ul style="list-style-type: none"> • 110 – 240 V 50/60 Hz • Female USB type A, 5 V 1 A Charging and connection cable <ul style="list-style-type: none"> • Male USB type A – Male USB type μ-B • 1.8 m

TEMPERATURE AND ROTATION SPEED MEASUREMENT PROBES

Model	Description
	C.A 1711 P01102082 Tachometer probe <ul style="list-style-type: none"> - Pulse output $\frac{1.1V}{0}$ / rev. - 2 insulated banana plugs Ø 4 mm - Measurement range: 6 to 120,000 RPM - IP 53
	C.A 801 P01652401Z Temperature adapter for multimeters <ul style="list-style-type: none"> - -40 °C to +1,000 °C - 1 mVdc / °C (or /°F) Delivered with 1 K sensor and 1 battery

Model	Description
	C.A 1871 P01651610Z Infrared sensor Compatible with any multimeter equipped with an mV range <ul style="list-style-type: none"> - Measurement range: -30 °C to +550 °C - Output: 1 mV/1 °C - Distance/spot ratio: 8/1 - Accuracy: ± 2 %
	C.A 803 P01652411Z Temperature adapter for multimeters <ul style="list-style-type: none"> - 2 measurement channels - -40 °C to +1,000 °C - 1 mVdc / °C (or /°F) - Ø1 - Ø2 differential measurement Delivered with 2 K sensors and 1 battery

ADAPTERS FOR TEMPERATURE MEASUREMENT SENSORS

Modèle	Description
	Set of 2 safety thermocouple adapters for multimeters P01102106Z Female thermocouple plug – insulated red/black male plugs Ø 4 mm with 19 mm spacing
	Safety adapter and K-sensor temperature probe P01102107Z For multimeters and multimeter clamps equipped with a temperature measurement calibre with 19 mm-spaced banana inputs <ul style="list-style-type: none"> - Measurement range from -50 °C to +350 °C - Sensor length: approx. 100 cm

Modèle	Description
	Pt100/Pt1000 sensor adapter for multimeters HX0091 Female Pt100/Pt1000 plug – Red/black insulated male plugs Ø 4 mm



Product	Standardized dimensions (mm)	Amperage	Reference
C.A 10	6 x 32	8 A	P01297013
C.A 1621	5 x 20	125 mA	P01297099
C.A 1631	5 x 20	125 mA	P01297099
C.A 401	6 x 32	1 A	P03297507
C.A 401	6 x 32	10 A	P03297510
C.A 4010	6 x 32	0.315 A	P03297509
C.A 4010	6 x 32	16 A	P03297505
C.A 4020	6 x 32	0.315 A	P03297509
C.A 4020	6 x 32	16 A	P03297505
C.A 403	6 x 32	0.315 A	P03297509
C.A 404	6 x 32	1.25 A	P01297015
C.A 405	6 x 32	6.3 A	P01297016
C.A 406	5 x 20	0.16 A	P03297508
C.A 406	6 x 32	3.15 A	P01100726
C.A 4300	6 x 32	1 A	P03297507
C.A 4300	6 x 32	10 A	P03297510
C.A 47	5 x 20	1 A	P01297075
C.A 47	5 x 20	4 A	P01297076
C.A 47	5 x 20	0.315 A	P01297074
C.A 5000	6 x 32	5 A	P01297035
C.A 5000	6 x 32	0.5 A	P01297028
C.A 5003	6 x 32	1.6 A	P01297036
C.A 5003	10 x 38	16 A	P01297037
C.A 5005	6 x 32	1 A	P01297039
C.A 5005	6 x 32	10 A	P01297038
C.A 5011	6 x 32	1 A	P01297039
C.A 5011	6 x 32	10 A	P01297038
C.A 5110	6 x 32	1 A	P03297507
C.A 5120	6 x 32	1 A	P03297507
C.A 5120	6 x 32	10 A	P03297510
C.A 5210	10 x 38	12 A	P01297021
C.A 5210	6 x 32	0.4 A	P01297020
C.A 5210G	10 x 38	12 A	P01297021
C.A 5210G	6 x 32	0.4 A	P01297020
C.A 5220	10 x 38	12 A	P01297021
C.A 5220	6 x 32	0.4 A	P01297020
C.A 5220G	10 x 38	12 A	P01297021
C.A 5220G	6 x 32	0.4 A	P01297020
C.A 5230G	10 x 38	12 A	P01297021
C.A 5230G	6 x 32	0.5 A	P01297028
C.A 5240G	10 x 38	12 A	P01297021
C.A 5233	6 x 32	10 A	AT0070
C.A 5240G	6 x 32	0.5 A	P01297028
C.A 5260G	6 x 32	0.1 A	P01297012
C.A 5271	10 x 38	10 A	P01297096
C.A 5273	10 x 38	10 A	P01297096
C.A 5275	6 x 32	0.63 A	P01297098
C.A 5275	10 x 38	10 A	P01297096
C.A 5277	6 x 32	0.63 A	P01297098
C.A 5277	10 x 38	10 A	P01297096
C.A 5287	10 x 38	11 A	P01297092
C.A 5287	10 x 38	0.44 A	P01297094
C.A 5289	10 x 38	11 A	P01297092
C.A 5289	10 x 38	0.44 A	P01297094
C.A 6114 / 15N	6 x 32	3.15 A	P01297080

Product	Standardized dimensions (mm)	Amperage	Reference
C.A 6115N	5 x 20	2 A	P01297026
C.A 6115N	6 x 32	3.15 A	P01297080
C.A 6121	5 x 20	1 A	P01297031
C.A 6121	5 x 20	4 A	P01297032
C.A 6121	6 x 32	0.2 A	P01297033
C.A 6121	10 x 38	20 A	P01297030
C.A 6160	6 x 32	16 A	P01297086
C.A 6160	5 x 20	2.5 A	P01297085
C.A 6240	6 x 32	12.5 A	P01297091
C.A 6250	5 x 20	2 A	P01297090
C.A 6250	6 x 32	16 A	P01297089
C.A 6421	6 x 32	0.1 A	P01297012
C.A 6423	6 x 32	0.1 A	P01297012
C.A 6425	6 x 32	0.1 A	P01297012
C.A 6460	6 x 32	0.1 A	P01297012
C.A 6462	6 x 32	0.1 A	P01297012
C.A 6470	5 x 20	0.63 A	AT0094
C.A 6472	5 x 20	0.63 A	AT0094
C.A 6501	6 x 32	0.2 A	P01297095
C.A 6503	6 x 32	0.2 A	P01297095
C.A 6511	6 x 32	1.6 A	P01297022
C.A 6513	6 x 32	1.6 A	P01297022
C.A 6521	6 x 32	0.63 A	P01297078
C.A 6523	6 x 32	0.63 A	P01297078
C.A 6525	6 x 32	0.63 A	P01297078
C.A 6531	6 x 32	0.63 A	P01297078
C.A 6541	6 x 32	0.1 A	P01297072
C.A 6541	8 x 50	2.5 A	P01297071
C.A 6543	6 x 32	0.1 A	P01297072
C.A 6543	8 x 50	2.5 A	P01297071
C.A 6545	5 x 20	0.1 A	P03297514
C.A 6547	5 x 20	0.1 A	P03297514
C.A 6549	5 x 20	0.1 A	P03297514
CADI 2	5 x 20	12.5 A	P01297004
CADI 2	5 x 20	3.15 A	P01297002
CAMPUS	5 x 20	0.16 A	P03297508
CAMPUS	6 x 32	3.15 A	P01100726
CdA 651	6 x 32	3.15 A	P01100726
CdA 651M	6 x 32	3.15 A	P01100726
CdA 778N	6 x 32	2 A	P03297513
CdA 778N	6 x 32	10 A	P03297502
CdA 791	8 x 32	6 A	P03100801
CdA 800	5 x 20	0.1 A	P03100201
CdA LAB'X 9000	5 x 20	1.6 A	P03297501
CdA100-A	6 x 32	0.4 A	P01297020
CONPAMATIC 2	10 x 38	10 A	P01100731
CONPAMATIC 2	6 x 32	3.15 A	P01100726
DETEC 220	5 x 20	0.315 A	P01297014
DTR 8500	5 x 20	1 A	P01297031
DTR 8500	5 x 20	4 A	P01297041
DTR 8500	5 x 20	0.5 A	P01297042
IMEG 500	5 x 20	0.2 A	P02297302
IMEG 500N	5 x 20	0.2 A	P02297302
ISOL 1000N G4	6 x 32	0.315 A	P01101724
ISOL 5000N G4	6 x 32	0.315 A	P01101724



Product	Standardized dimensions (mm)	Amperage	Reference
LOCAT 110	5 x 20	0.1 A	P03297514
LOCAT 220	5 x 20	0.1 A	P03297514
MANIP W1	6 x 32	1.25 A	P01297015
MANIP Z10	5 x 20	0.16 A	P03297508
MAN'X 015	6 x 32	1.6 A	P01297017
MAN'X 02S	6 x 32	2 A	P03297513
MAN'X 02S	10 x 38	10 A	P01100731
MAN'X 04B	8 x 32	10 A	P03100830
MAN'X 04B	5 x 20	1.6 A	P03297501
MAN'X 102	5 x 20	0.160 A	P03297508
MAN'X 102	6 x 32	3.15 A	P01100726
MAN'X 500	6 x 32	2 A	P03297513
MAN'X 500	6 x 32	16 A	P03297505
MAN'X 520A	6 x 32	0.315 A	P03297509
MAN'X 520A	6 x 32	16 A	P03297505
MAN'X TOP	6 x 32	0.315 A	P03297509
MAN'X TOP	6 x 32	16 A	P03297505
MAN'X TOP PLUS	6 x 32	0.315 A	P03297509
MAN'X TOP PLUS	6 x 32	16 A	P03297505
MAX 2000	6 x 32	1 A	P03297510
MAX 2000	6 x 32	10 A	P03297510
MAX 3000	6 x 32	1 A	P03297510
MAX 3000	6 x 32	10 A	P03297510
MH600	5 x 20	0.16 A	P01297043
MH600	5 x 20	0.310 A	P01297045
MH600	5 x 20	0.315 A	P01297074
RO600	5 x 20	2 A	P01297069
RO600	5 x 20	0.25 A	P01297070
Tellurohm C.A 2	6 x 32	0.1 A	P01297012
C.A 5001	6 x 32	0.5 A	P01297028
C.A 5001	6 x 32	5 A	P01297035
C.A 6522	6 x 32	0.63 A	P01297078
C.A 6524	6 x 32	0.63 A	P01297078
C.A 6526	6 x 32	0.63 A	P01297078
C.A 6532	6 x 32	0.63 A	P01297078
C.A 6534	6 x 32	0.63 A	P01297078
C.A 6536	6 x 32	0.63 A	P01297078
C.A 6471	5 x 20	0.63 A	AT0094



A	
Accessories kit	104, 231
Air (temperature sensors)	188
Analogue multimeter	31
Analogue/digital multimeter	35
Anemometer	174
Artificial neutral box AN1	229
B	
Bag	232
BT modem, USB	86
C	
Cable (see measurement leads)	238
Cable break locator	98
Cable locator	98
Cable tester	98, 199
Cable/wiring testers	98
Calibrator	154
Clamp multimeter	42, 118
Clamp transformer	221
Continuity test	24, 62, 66, 78, 87, 91, 92
Crocodile clips	240
Current clamp	219
Current logger	126
Current measurement clamp	42, 118, 221
Current measurement	219
Current sensor	221
Current transformer (measurement on secondary of)	227
D	
Data acquisition	126
Data logging	126
Decade box (resistors, capacitors)	213
Digital multimeter	35
Digital ohmmeter	70, 71
E	
Earth clamp	86
Earth measurement	62, 78
Earth resistance	62
Earth tester	78
Educational measuring instruments	205
Electrical energy analyser	118
Electrical equipment tester	87
Electrical installation tester	62
Electromagnetic disturbance analyser	195
Electromagnetic field measurement	200
Energy analysis software	142
Energy management and analysis	118, 128
ESSAILEC adapter box	144
F	
Fault detector (breaks, short-circuits)	98
Field meter	200, 201
Flexible current sensor	40, 224, 226
Free-space propagation	208
Fuse	243
G	
Gas detector	184, 185
Gaussmeter	200, 201
Guided propagation	208
H	
Hall-effect clamps	221
Hard cases	232
Harmonics clamp	44, 45, 118
Humidity detector	174, 175, 184
Humidity tester	174, 175, 184
Hygrometry measurement	174, 175, 184
I	
Illuminance measurement	179

Infrared camera	157
Infrared probe	167, 242
Infrared thermometer	164
Inrush current	44, 45, 118
Insulated current probe	224
Insulation fault	66
Insulation-piercing clip	241
Insulation resistance measurement	62, 66, 78, 87
Insulation tester	66, 87
Ionization current	39
IP2X (accessory)	238

K	
Kelvin clamp	93 to 95, 226
Kelvin test probe	93 to 95, 106

L	
Laboratory measuring instrument	205
Laboratory shunt	217
LAN network tester	199
LAN Tester	199
Laser thermometer sighting	164
Leakage current clamp	77, 86
Lighting measurement	179
Lightmeter	179
Loop ohmmeters	62, 86
Loop tester	62, 86, 90

M	
Mains adapters	240, 241
Manometer	178
Measurement lead	238

Megohmmeter (see Insulation Testers)	66
Micro-ohmmeter	93 to 95
Microwave measurement	195
Milliohmmeter	93 to 95
Multi-function testers	64, 90, 177
Multimeter accessories	231
Multimeter clamp	42, 120, 121
Multi-tester	24

N	
Null galvanometer	214

O	
Oscilloscope accessories	228
Oscilloscope current probe	228

P	
Phase (detection, sequence testers)	24, 97
Phase rotation	97
Phase sequence tester	64, 90, 97
Phase shift measurement	118
Photoelectric cell (light metering)	179
Physical measurement probe	188
Portable ammeter	214
Power analyser	118
Power factor measurement	42, 118
Power logger	126
Power measurement	118
Probe for oscilloscope	228
Process current measurement clamp	226
Protection (soft case, hard case, bag)	232
Protection and transport accessories	232
Pt resistance	190
Pyranometer	141

R	
Radiofrequency measurement	195
Ratiometer	96
RCD testers	62, 90
Reflectometer	202
Relative humidity logger	184
Resistance (decade box)	215
Resistivity tester	78

Rotation speed measurement	182
----------------------------	-----

S	
Shockproof protective sheath	236
Short-circuit location	98
Soft case	232
Soil resistivity measurement	78
Solar power	139
Sound level meter	180, 181
Surface temperature sensors	188
Stroboscope	183

T	
Tachometer probe	242
Tachometer	182
Telephony (line measurement)	199
Temperature logger	138
Temperature measurement	157, 164
Temperature sensor	138, 188, 207
Teslammeter	200
Test accessories	238
Test probe	238
THD (Total Harmonic Distortion)	44, 45, 118
Thermo-anemometer	176
Thermocouple	188
Thermography	157, 207
Thermo-hygrometer	174, 175, 177
Training bench	207
Transient measurement	124
Transport (soft cases, hard cases, bags)	232

U	
USB mains adapter	192

V	
Varmeter	118
Voltage absence tester (VAT)	28
Voltage logger	126
Voltage tester	24

W	
Wattmeter clamp	42, 118
Wattmeter	118, 214
Wheatstone bridge	215
Wire grip	241



BY PRODUCT NAME

A	
A110 / A130	226
A193	144
A196	144
AmpFlex mains adapter	229
AL834	134
AmpFlex®	226
AN1	107,229
B	
B102	222, 227
BC05	216
BDH R100	208
BL07	217
Bluetooth® adapter	86, 107
BR04 to BR07	215
C	
C.A 1052	177
C.A 1110	179
C.A 1227	176
C.A 1246	68
C.A 1510	184
C.A 1621 / C.A 1623	155
C.A 1631	156
C.A 1725 / C.A 1727	182
C.A 1821 / C.A 1822	170
C.A 1823	171
C.A 1864 / C.A 1866	166
C.A 1871	167
C.A 1875	207
C.A 1882	160
C.A 1886	161
C.A 1888	162
C.A 1950	158
C.A 40	200
C.A 401 to C.A 406	214
C.A 41 / C.A 43	201
C.A 5001 to C.A 5005	32
C.A 5011	33
C.A 5231 / C.A 5233	37
C.A 5271 / C.A 5273	38
C.A 5275 / C.A 5277	39
C.A 6030	63
C.A 6113 / C.A 6116N / C.A 6117	64
C.A 6121	88
C.A 6155	90
C.A 6160	89
C.A 6240	93
C.A 6250	94
C.A 6292	95
C.A 6416 / C.A 6417	86
C.A 6421 / C.A 6423	80
C.A 6460 / C.A 6462	81
C.A 6470N TERCA 3	82
C.A 6471	83
C.A 6472	84
C.A 6474	85
C.A 6501 / C.A 6503	68
C.A 6505	73
C.A 6511 / C.A 6513	69
C.A 6522 / C.A 6524 / C.A 6526	70
C.A 6532 / C.A 6534 / C.A 6536	71
C.A 6541 / C.A 6543	72
C.A 6545 / C.A 6547	74
C.A 6549	75
C.A 6550 / C.A 6555	76
C.A 6608 / C.A 6609	97
C.A 6630	99
C.A 6681	98
C.A 6710	211
C.A 702 / C.A 703	36
C.A 7028	199
C.A 732	25
C.A 742	29
C.A 745N	26
C.A 755 / C.A 757	27
C.A 753	241
C.A 762	29
C.A 771 / C.A 773	30
C.A 8220	122
C.A 8230	123
C.A 832	180
C.A 8331	124
C.A 8333	124
C.A 8336	124
C.A 834	181
C.A 8435	124
C.A 847	175
C.A 850 / C.A 852	178
C.A 871 / C.A 879	165
C.A 876	168
C.A 895	185
C100 to C173	222 to 227
C160	228
C172 / C176	63
C177 / C177A	102
C182	109
C193	144
CA Link	103
C.Am Report	159
CDA 9452	183
CE Link	105
CK1 to CK4	190
CL601	131
D	
D30N à D38N	212, 218
Dataview®	100, 142, 186
DigiFlex	41
DTR 8510	96
E	
E1N to E6N	223
E3N adapter	144
E clamp mains adapter	229
ESSAILEC	144
F	
F201 / F203 / F205	43
F401 / F403 / F405	44
F407	44, 120
F601 / F603 / F605	45
F607	45, 121
F62 / F65	77
FTV100	140
FTV200	141
G	
GreenTest	140, 141
I	
I-V Tracer	140, 141
J	
J93	144
K	
K1 / K2	223
K clamp mains adapter	229
L	
L101 / L102 / L111	132
L261	135
L452	137
L481	135
L562	130
L642	138
LOCAT_N	98
M	
MA110 / MA130	224
MA193	144
MA200	224, 228
MA400D / MA4000D	41
Machine Link	105
Mains adapter	102, 107
MINI01 à MINI09	222
MiniFlex®	224
MiniFlex® mains adapter	229
ML912	133
ML914	134
MN08 à MN89	222
MN20	107
MN60	228
MN71	227
MN73	227
MN77	102
MN82	109
MN93 / MN93A	144
Multifix	233
P	
PAC10 to PAC12	223
PAC20 to PAC22	223
PAC93	144
PAC clamp mains adapter	229
Power - Harmonics Case	212
PEL 102 / PEL 103	128
PEL 105	129
PEL Transfer	128
Physics Log	177
Power pack type 2	144
Printer n°5	107
Q	
QualiSTAR+	124
R	
RayCAm Report	163
Reeling box	233
RW 501	202
RW5012	202
RW511	202
RW521	202
S	
Simple Logger 2	130 à 135
SK1 à SK20	188
SP10 à SP13	190
T	
TERCA3	82
TK2000 / TK2002	169
U	
USB mains adapter	229
Y	
Y1N to Y7N	222, 228



AG-1066Z	241	P01102048	191	P01120001A	222
HX0051B	242	P01102052Z	130, 135, 147	P01120005A	222
HX0053	242	P01102053Z	47, 241	P01120028A	222
HX0055	147	P01102055Z	47, 241	P01120029A	222
HX0056-Z	108, 110	P01102056	93, 94, 106	P01120030A	223
HX0061	102, 146, 191	P01102057	102, 146	P01120040A	223
HX0064	241	P01102057Z	146	P01120043A	144, 175, 223, 228
HX0091	122, 146, 242	P01102059	146	P01120047	146, 228
P01100620	46 à 48, 145, 166	P01102081	146	P01120049A	222
P01101141	109	P01102082	122, 146, 242	P01120050A	222
P01101783	93, 94, 106, 110	P01102083	192	P01120051A	222
P01101785	192	P01102084A	102	P01120052A	222
P01101794	106, 110	P01102085	180, 181, 192	P01120053A	222
P01101797	192	P01102092A	70, 71, 102	P01120054A	222
P01101841	89, 105, 109	P01102094	102	P01120055A	222
P01101842	109	P01102095	100, 142, 186	P01120056A	222
P01101846	147, 241	P01102097	47, 186, 242	P01120057A	145, 222, 228
P01101847	241	P01102099	146	P01120064	222
P01101892A	215, 216	P01102100Z	41, 46 à 48, 191, 233, 234, 236	P01120067A	223, 227
P01101905	107	P01102101Z	241	P01120068	223
P01101906A	107	P01102103	99, 106, 110	P01120069	223
P01101915	88, 105	P01102106Z	47, 48, 212	P01120070	47, 222
P01101916	105	P01102107Z	47, 48, 242	P01120071	223
P01101917	105	P01102112	48, 86, 108, 192	P01120072	145, 223, 228
P01101918	105	P01102113	46, 48	P01120073	145, 223, 228
P01101919	105	P01102114Z	106, 241	P01120074A	223, 227
P01101921	102	P01102115	147	P01120075	222, 228
P01101922	102	P01102116	147	P01120079B	144
P01101935	72, 107	P01102117	146	P01120083	222, 227
P01101935A	107	P01102121Z	46	P01120092	147
P01101941	107	P01102123Z	46, 240	P01120100	147
P01101943	102	P01102124Z	46, 240	P01120110	144
P01101959	144	P01102125Z	46, 240	P01120301	222
P01101966	229	P01102126Z	46, 240	P01120302	222
P01101967	146, 229	P01102127Z	46, 240	P01120303	145, 222
P01101968	229	P01102128Z	46, 240	P01120304	222
P01101980	211	P01102129	102	P01120305	222
P01101981	211	P01102130	102	P01120306	222
P01101994	199, 203	P01102134	128, 146	P01120307	222
P01101995	199, 203	P01102135	105	P01120308	145, 222, 228
P01101996	89, 105	P01102136	105	P01120309	222, 227
P01101997Z	46	P01102137	105	P01120310	63, 104, 107
P01102008Z	29, 46, 240	P01102138	105	P01120314	222
P01102009Z	46, 240	P01102139	105	P01120315	222
P01102010	177, 191	P01102140	105	P01120316	222
P01102011	177, 191	P01102141	105	P01120317	222
P01102012	191	P01102142	105	P01120323B	144
P01102013	106	P01102143	105	P01120330	63, 107
P01102014	110	P01102144	105	P01120333	104, 109
P01102017	102, 104	P01102145	105	P01120335	102, 104
P01102018	102, 104	P01102146	129, 146	P01120336	102, 104
P01102019	98	P01102148	137, 147	P01120337	147
P01102020	104, 107	P01102149	144, 233	P01120401	222
P01102021	102, 104	P01102152Z	26, 27, 46	P01120402	222
P01102022	102, 104	P01102153Z	46	P01120403	222
P01102023	104	P01102154Z	46	P01120404	46, 145, 222
P01102024	85, 104	P01102903	88, 107	P01120405	222
P01102025	104	P01102986	229	P01120406	222
P01102026	104, 107	P01102987	229	P01120407	222
P01102028	104	P01103057	155, 156, 191	P01120408	222
P01102029	104	P01103058Z	146, 241	P01120409	145, 222, 228
P01102030	104	P01103059Z	240	P01120410	222
P01102031	104, 107	P01103060Z	240	P01120415	222
P01102033	29, 46	p01103061Z	240	P01120416	222
P01102034	46	P01103062	76, 107, 108	P01120417	222
P01102035	108	P01103063	106	P01120418	222
P01102036	82 à 84, 108	P01103065	106	P01120419	222
P01102037	104	P01105101Z	222	P01120420	222, 227
P01102040	104	P01105102Z	222	P01120421	222, 227
P01102045	109	P01105103Z	47, 222	P01120425B	144
P01102046	104	P01105105Z	222	P01120434B	144
P01102047	104	P01105109Z	46, 222	P01120440	107



BY REFERENCE

P01120452	109	P01145445	64	P01191740Z	36
P01120460	102	P01145455	64	P01191742A	25
P01120470	106, 110	P01145460	64	P01191742D	29
P01120526B	144	P01145601	88	P01191742Z	29
P01120531B	144	P01145801	89	P01191743Z	26
P01120550	104, 109	P01145901	211	P01191745Z	25
P01120551	104, 109	P01146001	90	P01191748Z	30, 46, 241
P01120567	144	P01156302Z	175	P01191755	27
P01120570	225, 228	P01156401	174, 191	P01191757	27
P01120571	225, 228	P01156402	174, 191	P01191762D	29
P01120572	225, 228	P01157155	129	P01191762Z	29
P01120575Z	41	P01157201	137	P01191771	30
P01120576Z	41	P01157702	96	P01191771A	30
P01120577Z	41	P01160511	124	P01191773	30
P01120580	144	P01160541	124	P01191773A	30
P01120591	46	P01160585	124	P01196311E	33
P01120630	226	P01160591	124	P01196311F	33
P01120631	226	P01160620	122	P01196521E	32
P01120632	226	P01160621	122	P01196521F	32
P01120633	226	P01160622	122	P01196522E	32
P01120660	225	P01160630	123	P01196522F	32
P01120661	225	P01160631	123	P01196523E	32
P01120662	225	P01160632	123	P01196523F	32
P01120663	225	P01160640	146	P01196731	37
P01120760	77	P01160700	140, 146	P01196733	37
P01120761	77	P01160710	147	P01196734	37
P01120921	43	P01160730	147	P01196771	38
P01120923	43	P01160731	147	P01196773	38
P01120925	43	P01160732	147	P01196775	39
P01120941	44	P01160733	147	P01196777	39
P01120943	44	P01160734	147	P01197201	229
P01120945	44	P01160735	147	P01197401	215
P01120947	44	P01160736	147	P01197402	215
P01120961	45	P01160737	147	P01197403	215
P01120963	45	P01160738	147	P01197404	215
P01120965	45	P01160739	147	P01197421	216
P01120967	45	P01160740	141	P01197451	217
P01122015	86	P01160745	141	P01255101	202
P01122016	86	P01165221	217	P01255102	202
P01122301	86	P01165222	217	P01255103	202
P01123011	80	P01165223	217	P01255104	202
P01126506	82	P01165224	217	P01255901	202, 203
P01126501	81	P01165225	217	P01255902	203
P01126502	81	P01167001B	20	P01275101	208
P01126504	84	P01167002A	201	P01275301	209
P01126505	83	P01167202B	201, 203	P01275302	209
P01126510	85	P01167501	200	P01275304	208, 209
P01126511	85	P01170301	214	P01275305	209
P01127013	80	P01170302	214	P01275306	209
P01129501	199	P01170303	214	P01275307	209
P01132503	68	P01170304	214	P01275308	209
P01132504	68	P01170305	214	P01275309	209
P01138901	72	P01170501	214	P01275310	209
P01138902	72	P01170701	214	P01275311	209
P01139701	74	P01173105	191	P01275312	209
P01139702	74	P01173107	191	P01275313	209
P01139703	75	P01174810	182	P01275314	209
P01139704	73	P01174830	182	P01275315	209
P01139705	76	P01174835	192	P01275316	209
P01139706	76	P01174902	182, 192	P01275318	209
P01140201	69	P01174903	182, 192	P01275325	208
P01140301	69	P01175020	177	P01275326	208
P01140822	70	P01184101	178	P01275327	208
P01140824	70	P01184102	178	P01275328	208
P01140826	70	P01185301	180, 181, 192	P01275329	208
P01140832	71	P01185501Z	180	P01275330	208
P01140834	71	P01185502	181	P01275331	208
P01140836	71	P01191303	99	P01275332	208
P01141626	98	P01191304	97	P01275333	208
P01143200	93	P01191305	97	P01275334	208
P01143201	94	P01191511	63	P01275335	208
P01143300	95	P01191739Z	36	P01275338	209



P01275339	209	P01295453Z	47, 70, 71, 107, 238	P01298040	233
P01275340	209	P01295454Z	47, 48, 76, 103, 107, 146, 239	P01298043Z	233
P01275341	209	P01295455Z	48, 238	P01298046	202, 203, 233
P01275343	209	P01295456Z	32, 37 à 39, 41, 48, 77, 108, 238	P01298049	107, 146, 233
P01275344	209	P01295457Z	47, 48, 77, 107 à 109, 120, 121	P01298051	107, 146, 233
P01275345	209	P01295458Z	47, 48, 107, 109, 191, 238	P01298055	146, 233
P01275346	209	P01295459Z	32, 33, 37 à 39, 43, 46, 239	P01298056	102, 233
P01275347	209	P01295460Z	47, 239	P01298057	102
P01275348	209	P01295461Z	47, 48, 238	P01298061A	233
P01275349	209	P01295462Z	46, 239	P01298065Z	36, 46, 108, 233
P01275350	209	P01295463Z	240	P01298066	104, 107 à 110, 146, 147, 233
P01275351	209	P01295464Z	240	P01298067	104, 109, 233
P01275352	209	P01295465	103	P01298068	233
P01275353	209	P01295466	103	P01298069	233
P01275357	209	P01295467	103	P01298071	184, 191, 192, 233
P01275358	209	P01295468	103	P01298072	192, 233
P01275359	209	P01295469	103	P01298074	41, 46, 48, 233
P01275360	209	P01295470	103	P01298075	48, 155, 156, 191, 233
P01275361	209	P01295471	103	P01298076	30, 46, 48, 132, 133, 138, 146, 147, 233
P01275362	209	P01295471A	103	P01298078	128, 134, 146, 147, 233
P01295056	215, 216	P01295472	103	P01298080	108
P01295094	102	P01295472A	103	P01298081	102
P01295097	105	P01295473	103	P01298082	102
P01295137	105	P01295473A	103	P01298532	203
P01295140	105	P01295474Z	239, 241	P01299921	63
P01295141	105	P01295475Z	239, 241	P01299930	85
P01295143A	96, 106	P01295476	144	P01637301	146
P01295171	107	P01295478	192	P01651001Z	185
P01295172	105, 107	P01295483	144	P01651010	184
P01295173	105, 107	P01295486	95, 106, 110	P01651011	184
P01295174	81, 102, 107, 108, 110, 146	P01295487	106, 110	P01651020	192
P01295212	211	P01295488	95, 106, 110	P01651021	192
P01295214	103	P01295489	137, 147	P01651022	184, 192
P01295215	103	P01296021	107, 108	P01651023	179, 191, 192, 229, 242
P01295216	103	P01296024	102, 146	P01651024	147
P01295217	103	p01296032	25 à 27, 36, 46	P01651101	185, 192
P01295218	103	P01296033	46, 48, 107, 108	P01651215	160
P01295219	103	P01296034	107	P01651215E	160
P01295220	103	P01296037	146	P01651260	161
P01295221	103	P01296041	191	P01651261	161
P01295231	103	P01296043	191	P01651262	161
P01295232	103	P01296045	160, 191	P01651263	161
P01295234	105	P01296046	160, 191	P01651270	162
P01295236	105	P01296047	102	P01651271	162
P01295252	107	P01297012	80, 81, 107, 108	P01651272	162
P01295253	106, 107	P01297028	46	P01651273	162
P01295260	104	P01297035	46	P01651302Z	165
P01295261	104	P01297036	46	P01651403Z	168
P01295262	104	P01297037	46	P01651522	191
P01295263	104	P01297038	46	P01651526	161, 162, 191
P01295264	104	P01297039	46	P01651527	191
P01295265	104	P01297086	105	P01651528	191
P01295266	104, 107	P01297022	107	P01651531	161, 162, 191
P01295267	104	P01297071	107	P01651532	191
P01295268	98, 107	P01297072	107	P01651610Z	46, 47, 108, 167, 242
P01295270	104	P01297095	107	P01651620	207
P01295271	85, 109	P01297101	110	P01651805Z	165
P01295272	85, 109	P01298004	233, 235, 237	P01651813	166
P01295274	191	P01298005	80, 108	P01651814	166
P01295285Z	46, 240	P01298006	68, 107, 108, 233	P01651901	158
P01295288Z	107, 130, 135, 146, 147, 218	P01298007	233	P01652401Z	46, 108, 242
P01295289Z	107, 238	P01298009B	201, 203, 235, 236	P01652411Z	46, 108, 242
P01295290Z	238	P01298011	233	P01653100	169
P01295291	104	P01298012	46, 233	P01653110	169
P01295292	104	P01298012Z	233	P01654246	68, 69, 73 à 75, 107
P01295293	96, 102, 110, 144, 192	P01298016	107, 214	P01654402	156
P01295294	109	P01298031	233	P01654621	155
P01295393	64, 102	P01298032	233	P01654623	155
P01295398	64, 102	P01298033	46, 165, 166, 233	P01654821	69, 72 à 75, 107
P01295450Z	238	P01298036	46, 200, 203, 223	P01NC5003	212
P01295451Z	47, 48, 120, 121, 146, 191, 238	P01298037	46, 233	P03100824	46
P01295452Z	238	P01298037A	233	P03197521A	215



P03197522A	215
P03197523A	215
P03197524A	215
P03197525A	215
P03197526A	215
P03197527A	215
P03197528A	215
P03197529A	215
P03197530A	215
P03197531A	215
P03197611A	215
P03197704	183
P03199611A	216
P03199612A	216
P03199613A	216
P03295509	32, 47, 108
P03297514	107
P03652712	190
P03652713	190
P03652714	190
P03652715	190
P03652901	189
P03652902	189
P03652903	189
P03652904	189
P03652905	189
P03652906	138, 147, 189
P03652907	189
P03652908	189
P03652909	190
P03652910	190
P03652912	190
P03652913	190
P03652914	190
P03652917	189
P03652918	189
P03652919	189
P03652920	189
P03652921	189
P03652922	189
P06239307	241
P06239502	46, 108, 233





CHAUVIN ARNOUX METRIX

190, rue Championnet
75876 PARIS Cedex 18
Tel.: +33 1 44 85 44 85
Fax: +33 1 46 27 07 48
info@chauvin-arnoux.fr
www.chauvin-arnoux.fr

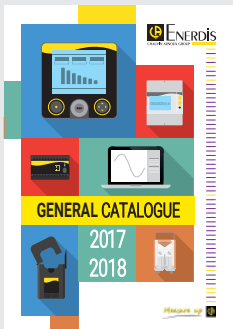

ENERDIS

16, rue Georges Besse - Silic 44
92182 ANTONY Cedex
Tel.: +33 1 75 60 10 30
Fax: +33 1 46 66 62 54
info@enerdis.fr - www.enerdis.fr

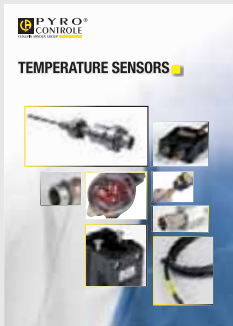

PYROCONTROLE

6 bis, av du Docteur Schweitzer
69881 MEYZIEU Cedex
Tel.: +33 4 72 14 15 40
Fax: +33 4 72 14 15 41
info@pyrocontrole.com
www.pyrocontrole.com



MANUMESURE

248, av des Grésillons
92600 ASNIÈRES sur SEINE
Tel.: +33 1 75 61 01 90
Fax: +33 1 47 33 28 02
info@manumasure.fr
www.manumasure.fr

10 SUBSIDIARIES WORLDWIDE

AUSTRIA

CHAUVIN ARNOUX GES.M.B.H

Slamastrasse 29/2/4
1230 WIEN
Tel.: +43 1 61 61 9 61
Fax: +43 1 61 61 9 61-61
vie-office@chauvin-arnoux.at
www.chauvin-arnoux.at

CHINA

SHANGHAI PU-JIANG ENERDIS INSTRUMENTS CO. LTD

3 Floor, Building 1
N° 381 Xiang De Road
200081 SHANGHAI
Tel.: +86 21 65 21 51 96
Fax: +86 21 65 21 61 07
info@chauvin-arnoux.com.cn

GERMANY

CHAUVIN ARNOUX GMBH

Ohmstraße 1
77694 KEHL / RHEIN
Tel.: +49 7851 99 26-0
Fax: +49 7851 99 26-60
info@chauvin-arnoux.de
www.chauvin-arnoux.de

ITALY

AMRA SPA

Via Sant' Ambrogio, 23
20846 MACHERIO (MB)
Tel.: +39 039 245 75 45
Fax: +39 039 481 561
info@amra-chauvin-arnoux.it
www.chauvin-arnoux.it

MIDDLE EAST

CHAU VIN ARNOUX MIDDLE EAST

PO Box 60-154
1241 2020 JAL EL DIB
(Beirut) - LEBANON
Tel.: +961 1 890 425
Fax: +961 1 890 424
camie@chauvin-arnoux.com
www.chauvin-arnoux.com

SPAIN

CHAUVIN ARNOUX IBERICA SA

C/ Roger de Flor N°293, 1a Planta
08025 BARCELONA
Tel.: +34 902 20 22 26
Fax: +34 934 59 14 43
info@chauvin-arnoux.es
www.chauvin-arnoux.es

SCANDINAVIA

CA MÄTSYSTEM AB

Sjöflögvägen 35
SE-183 62 TABY
Tel.: +46 8 50 52 68 00
Fax: +46 8 50 52 68 10
info@camatsystem.com
www.camatsystem.com

SWITZERLAND

CHAUVIN ARNOUX AG

Moosacherstrasse 15
8804 AU / ZH
Tel.: +41 44 727 75 55
Fax: +41 44 727 75 56
info@chauvin-arnoux.ch
www.chauvin-arnoux.ch

UNITED KINGDOM

CHAUVIN ARNOUX LTD

Unit 1 Nelson Ct, Flagship Sq
Shaw Cross Business Pk, Dewsbury
West Yorkshire - WF12 7TH
Tel: +44 1924 460 494
Fax: +44 1924 455 328
info@chauvin-arnoux.co.uk
www.chauvin-arnoux.com

USA

CHAUVIN ARNOUX INC D.B.A AEMC INSTRUMENTS

200 Foxborough Blvd.
Foxborough - MA 02035
Tel.: +1 (508) 698-2115
Fax: +1 (508) 698-2118
sales@aemc.com
www.aemc.com

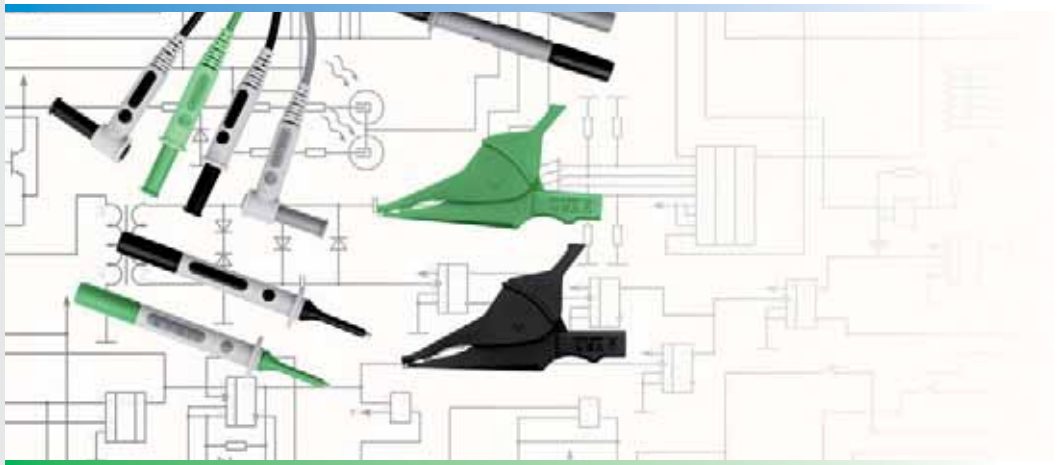

A CENTRALIZED CONTACT

CHAUVIN ARNOUX

190, rue Championnet
75876 PARIS Cedex 18 FRANCE

FRANCE

Tel.: +33 1 44 85 44 85
Fax: +33 1 46 27 73 89
info@chauvin-arnoux.fr
www.chauvin-arnoux.com

INTERNATIONAL

Tel: +33 1 44 85 44 38
Tel.: +33 1 46 27 95 59
export@chauvin-arnoux.fr
www.chauvin-arnoux.com

UNITED KINGDOM

CHAU VIN ARNOUX LTD

Unit 1 Nelson Ct, Flagship Sq
Shaw Cross Business Pk, Dewsbury
West Yorkshire - WF12 7TH
Tel: 01924 460 494
Fax: 01924 455 328
info@chauvin-arnoux.co.uk
www.chauvin-arnoux.com

MIDDLE EAST

CHAUVIN ARNOUX MIDDLE EAST

PO Box 60-154
1241 2020 JAL EL DIB (Beirut)
LEBANON
Tel.: (01) 89 04 25
Fax: (01) 89 04 24
camie@chauvin-arnoux.com
www.chauvin-arnoux.com

USA

CHAUVIN ARNOUX INC D.B.A AEMC INSTRUMENTS

200 Foxborough Blvd.
Foxborough - MA 02035
Tel.: +1 (508) 698-2115
Fax: +1 (508) 698-2118
sales@aemc.com
www.aemc.com

