

Digital Storage Oscilloscope

SEFRAM 5352DC 5372DC 53102DC

USER MANUAL

M53X2DC A 00



Table of Contents

SAFETY INSTRUCTIONS	10
Safety Symbols.....	10
Safety Guidelines.....	11
Power cord for the United Kingdom	15
GETTING STARTED.....	16
Main Features	16
Panel Overview.....	18
Front Panel.....	18
Rear Panel.....	23
Display.....	24
Setting up the Oscilloscope	26
QUICK REFERENCE.....	29
Menu Tree and Shortcuts.....	29
CH1/CH2 key.....	30
Cursor key 1/2.....	31
Cursor key 2/2.....	31
Display key.....	33
Autoset key.....	33
Hardcopy key.....	33
Help key.....	34
Horizontal menu key.....	35
Math key 1/2 (+/-).....	35
Math key 2/2 (FFT).....	36

Measure key	37
Run/Stop key	37
Save/Recall key 1/9.....	38
Save/Recall key 2/9.....	38
Save/Recall key 3/9.....	39
Save/Recall key 4/9.....	39
Save/Recall key 5/9.....	40
Save/Recall key 6/9.....	40
Save/Recall key 7/9.....	42
Save/Recall key 8/9.....	43
Save/Recall key 9/9.....	43
Trigger key 1/5	45
Trigger key 2/5	45
Trigger key 3/5	47
Trigger key 4/5	47
Trigger key 5/5	49
Utility key 1/10 (Utility #1).....	49
Utility key 2/10 (Utility #2).....	51
Utility key 3/10 (Utility #3).....	52
Utility key 4/10 (Hardcopy -Save All)	52
Utility key 5/10 (Hardcopy -Save Image)	52
Utility key 6/10 (Probe compensation)	54
Utility key 7/10 (Go-NoGo).....	54
Utility key 8/10 (Data Logging 1/2).....	55
Utility key 9/10 (Data Logging 2/2).....	55
Utility key 10/10 (Self CAL Menu)	56
Default Settings	57
Built-in Help	58
MEASUREMENT	60

Basic Measurements	60
Activating a channel	60
Using Autoset	61
Running and stopping the trigger	62
Changing the horizontal position and scale	63
Changing the vertical position and scale	64
Using the probe compensation signal	66
Automatic Measurements.....	68
Measurement items	68
Automatically measuring the input signals.....	71
Cursor Measurements.....	72
Using the horizontal cursors	72
Using the vertical cursors	73
Math Operations.....	75
Overview.....	75
Adding, subtracting or multiplying signals.....	76
Using the FFT function.....	77
Go No-Go Testing.....	79
Overview.....	79
Edit: NoGo When	80
Edit: Source	80
Edit: NoGo Violation Conditions	82
Edit: Template (boundary)	82
Run Go-NoGo Tests.....	87
Data Logging	88
Overview.....	88
Edit: Source	89
Edit: Setup Parameters.....	89
Run Data logging.....	91

CONFIGURATION	92
Acquisition	92
Selecting the acquisition mode.....	92
Real time vs Equivalent time sampling mode.....	95
Display	96
Selecting vector or dot drawing	96
Accumulating the waveform.....	96
Adjusting the display contrast	97
Selecting the display grid.....	97
Horizontal View	99
Moving the waveform position horizontally.....	99
Selecting the horizontal scale	99
Selecting the waveform update mode	100
Zooming the waveform horizontally.....	102
Viewing waveforms in the X-Y mode.....	104
Vertical View (Channel)	106
Moving the waveform position vertically	106
Selecting the vertical scale.....	106
Selecting the coupling mode	106
Inverting the waveform vertically	107
Limiting the waveform bandwidth.....	108
Trigger.....	109
Trigger type.....	109
Trigger parameter	110
Configuring the edge trigger	112
Configuring the video trigger	114
Configuring the pulse width trigger	115
Manually triggering the signal.....	116
Rear Panel USB Port Interface.....	118

System Settings	120
Viewing the system information	120
Selecting the language	120

SAVE/RECALL 122

File Structures	122
Display image file format	122
Waveform file format	122
Setup file format	125
Using the USB file utilities	126
Quick Save (HardCopy)	128
Save	130
File type/source/destination	130
Saving the panel settings	131
Saving the waveform	132
Saving the display image	133
Saving all (panel settings, display image, waveform)	135
Recall	137
File type/source/destination	137
Recalling the default panel settings	138
Recalling a reference waveform to the display	140
Recalling panel settings	140
Recalling a waveform	141

MAINTENANCE 144

Vertical Resolution Calibration	144
Probe Compensation	145

FAQ 147

The input signal does not appear in the display.147
I want to remove some contents from the display...147
The waveform does not update (frozen).....149
The probe waveform is distorted.....149
Autoset does not catch the signal well.....149
I want to clean up the cluttered panel settings.....149
The saved display image is too dark on the background.....149
The accuracy does not match the specifications.....151

APPENDIX 152

Fuse Replacement..... 152
Specifications 154
 Model-specific specifications.....154
 Common specifications155
Probe Specifications 159
 Probe for 5352DC and 5372DC.....159
 Probe for 53102DC160
 Dimensions161

S SAFETY INSTRUCTIONS

This chapter contains important safety instructions that should be followed when operating and storing the oscilloscope. Read the following before any operation to ensure your safety and to keep the oscilloscope in the best condition.

Safety Symbols

These safety symbols may appear in this manual or on the oscilloscope.



WARNING

Warning: Identifies conditions or practices that could result in injury or loss of life.



CAUTION

Caution: Identifies conditions or practices that could result in damage to the oscilloscope or to other objects or property.



DANGER High Voltage



Attention: Refer to the Manual



Protective Conductor Terminal



Earth (Ground) Terminal



Do not dispose electronic equipment as unsorted municipal waste. Please use a separate collection facility or contact the supplier from which this instrument was purchased.

Safety Guidelines

General Guideline



CAUTION

- Make sure the BNC input voltage does not exceed 300V peak.
- Never connect a hazardous live voltage to the ground side of the BNC connectors. It might lead to fire and electric shock.
- Do not place heavy objects on the oscilloscope.
- Avoid severe impact or rough handling that may damage the oscilloscope.
- Avoid discharges of static electricity on or near the oscilloscope.
- Use only mating connectors, not bare wires, for the terminals.
- Do not block the cooling fan vent.
- Do not perform measurements at power sources and building installation sites (Note below).
- The oscilloscope should only be disassembled by a qualified technician.

(Measurement categories) EN 61010-1:2001 specifies the measurement categories and their requirements as follows. The OSCILLOSCOPE falls under category II.

- Measurement category IV is for measurement performed at the source of a low-voltage installation.
- Measurement category III is for measurement performed in a building installation.
- Measurement category II is for measurement performed on circuits directly connected to a low voltage installation.
- Measurement category I is for measurements performed on circuits not directly connected to Mains.

Power Supply



WARNING

- AC Input voltage: 100 ~ 240V AC, 47 ~ 63Hz
- The power supply voltage should not fluctuate more than 10%.
- Connect the protective grounding conductor of the AC power cord to an earth ground.

Fuse



WARNING

- Fuse type: T1A/250V
- To ensure fire protection, replace the fuse only with the specified type and rating.
- Disconnect the power cord before replacing the fuse.
- Make sure the cause of fuse blowout is fixed before replacing the fuse.

Cleaning the oscilloscope

- Disconnect the power cord before cleaning the oscilloscope.
 - Use a soft cloth dampened in a solution of mild detergent and water. Do not spray any liquid into the oscilloscope.
 - Do not use chemicals containing harsh products such as benzene, toluene, xylene, and acetone.
-

- Operation Environment
- Location: Indoor, no direct sunlight, dust free, almost non-conductive pollution (Note below)
 - Relative Humidity: $\leq 80\%$, 40°C or below
 $\leq 45\%$, $41^{\circ}\text{C}\sim 50^{\circ}\text{C}$
 - Altitude: $< 2000\text{m}$
 - Temperature: 0°C to 50°C

(Pollution Degree) EN 61010-1:2001 specifies pollution degrees and their requirements as follows. The oscilloscope falls under degree 2.

Pollution refers to "addition of foreign matter, solid, liquid, or gaseous (ionized gases), that may produce a reduction of dielectric strength or surface resistivity".

- Pollution degree 1: No pollution or only dry, non-conductive pollution occurs. The pollution has no influence.
- Pollution degree 2: Normally only non-conductive pollution occurs. Occasionally, however, a temporary conductivity caused by condensation must be expected.
- Pollution degree 3: Conductive pollution occurs, or dry, non-conductive pollution occurs which becomes conductive due to condensation which is expected. In such conditions, equipment is normally protected against exposure to direct sunlight, precipitation, and full wind pressure, but neither temperature nor humidity is controlled.

-
- Storage environment
- Location: Indoor
 - Storage Temperature: $-10^{\circ}\text{C}\sim 60^{\circ}\text{C}$, no condensation-
 - Relative Humidity: 93% @ 40°C
 65% @ $41^{\circ}\text{C} \sim 60^{\circ}\text{C}$
-

Disposal



Do not dispose this instrument as unsorted municipal waste. Please use a separate collection facility or contact the supplier from which this instrument was purchased. Please make sure discarded electrical waste is properly recycled to reduce environmental impact.

Power cord for the United Kingdom

When using the oscilloscope in the United Kingdom, make sure the power cord meets the following safety instructions.

NOTE: This lead/appliance must only be wired by competent persons



WARNING: THIS APPLIANCE MUST BE EARTHED

IMPORTANT: The wires in this lead are coloured in accordance with the following code:

Green/ Yellow: Earth

Blue: Neutral

Brown: Live (Phase)



As the colours of the wires in main leads may not correspond with the coloured marking identified in your plug/appliance, proceed as follows:

The wire which is coloured Green & Yellow must be connected to the Earth terminal marked with either the letter E, the earth symbol  or coloured Green/Green & Yellow.

The wire which is coloured Blue must be connected to the terminal which is marked with the letter N or coloured Blue or Black.

The wire which is coloured Brown must be connected to the terminal marked with the letter L or P or coloured Brown or Red.

If in doubt, consult the instructions provided with the equipment or contact the supplier.

This cable/appliance should be protected by a suitably rated and approved HBC mains fuse: refer to the rating information on the equipment and/or user instructions for details. As a guide, a cable of 0.75mm² should be protected by a 3A or 5A fuse. Larger conductors would normally require 13A types, depending on the connection method used.

Any exposed wiring from a cable, plug or connection that is engaged in a live socket is extremely hazardous. If a cable or plug is deemed hazardous, turn off the mains power and remove the cable, any fuses and fuse assemblies. All hazardous wiring must be immediately destroyed and replaced in accordance to the above standard.

G

ETTING STARTED

The Getting started chapter introduces the oscilloscope's main features, appearance, and set up procedure.

Main Features

Model name	Frequency bandwidth	Input channels
5352DC	DC –50MHz (–3dB)	2
5372DC	DC – 70MHz (–3dB)	2
53102DC	DC – 100MHz (–3dB)	2
Performance	<ul style="list-style-type: none"> • 250MSa /S real-time sampling rate • 25GS/s equivalent-time sampling rate • Up to 10ns peak detection • 2mV~10V vertical scale 	
Features	<ul style="list-style-type: none"> • 5.7 inch color TFT display • Saving and recalling setups and waveforms • 19 automatic measurements • Multi-language menu (12 languages) • Math operation: Addition, Subtraction, FFT • Data logging • Go-NoGo testing 	

	<ul style="list-style-type: none">• Edge, video, pulse width trigger• Compact size: (W) 310 x (D) 140 x (H) 142 mm
Interface	<ul style="list-style-type: none">• USB 2.0 full-speed interface for saving and recalling data• Calibration output• External trigger input• USB B type (slave) interface for remote control

Panel Overview

Front Panel

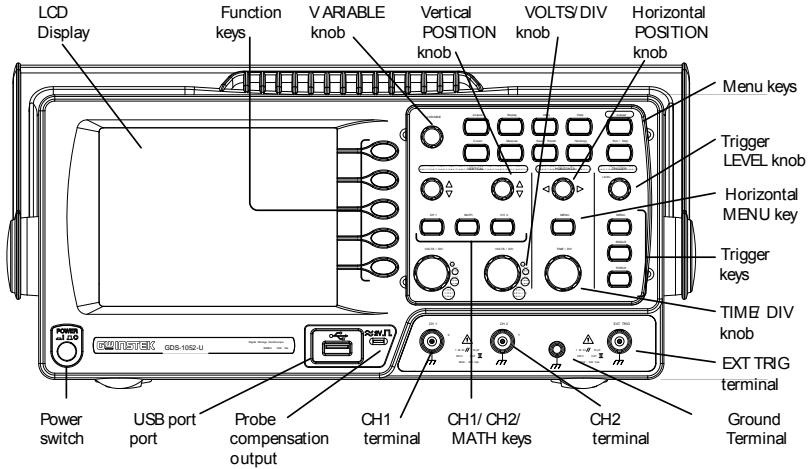

LCD display TFT color, 320 x 234 resolution, wide angle view LCD display.

Function keys:  Activates the functions which appear in the left side of the LCD display.
 F1 (top) to
 F5 (bottom)

Variable knob  VARIABLE Increases or decreases values and moves to the next or previous parameter.

Acquire key  Acquire Configures the acquisition mode (page 92).











Display key  Display Configures the display settings (page 96).











Cursor key





Runs cursor measurements (page 72).

(Continued on next page)

Utility key		Configures the Hardcopy function (page 128), shows the system status (page 120), selects the menu language (page 120), runs the self calibration (page 144), configures the probe compensation signal (page 145), and selects the USB host type (page 118).
Help key		Shows the Help contents on the display (page 58).
Autoset key		Automatically configures the horizontal, vertical, and trigger settings according to the input signal (page 61).
Measure key		Configures and runs automatic measurements (page 68).
Save/Recall key		Saves and recalls images, waveforms, or panel settings (page 122).
Hardcopy key		Stores images, waveforms, or panel settings to USB (page 128).
Run/Stop key		Runs or stops triggering (page 62).
Trigger level knob		Sets the trigger level (page 109).
Trigger menu key		Configures the trigger settings (page 109).
Single trigger key		Selects the single triggering mode (page 116).

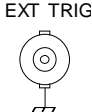
Trigger force key		Acquires the input signal once regardless of the trigger condition at the time (page 116).
Horizontal menu key		Configures the horizontal view (page 99).
Horizontal position knob		Moves the waveform horizontally (page 99).
TIME/DIV knob		Selects the horizontal scale (page 99).
Vertical position knob		Moves the waveform vertically (page 106).
CH1/CH2 key		Configures the vertical scale and coupling mode for each channel (page 106).
VOLTS/DIV knob		Selects the vertical scale (page 106).
Input terminal		Accepts input signals: $1M\Omega \pm 2\%$ input impedance, BNC terminal.
Ground terminal		Accepts the DUT ground lead to achieve a common ground.
MATH key		Performs math operations (page 75).
USB port		Facilitates transferring waveform data, display images, and panel settings (page 126).

Probe compensation output		Outputs a 2Vp-p, square signal for compensating the probe (page 145) or demonstration.
External trigger input		Accepts an external trigger signal (page 110).
Power switch		Powers the oscilloscope on or off.

Rear Panel

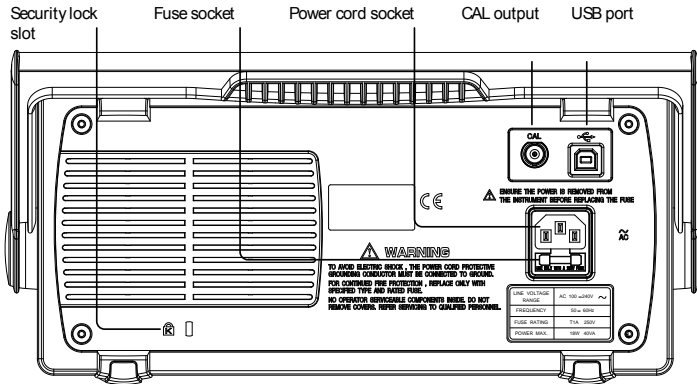

Power cord socket

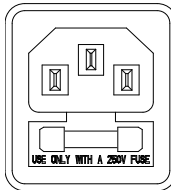

Power cord socket accepts the AC mains, 100 ~ 240V, 50/60Hz.

The fuse socket holds the AC main fuse, T1A/250V.

Fuse socket

For the fuse replacement procedure, see page 152.

USB slave port

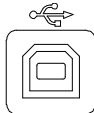

Accepts a type B (slave) male USB connector for remote control of the oscilloscope (page 118).

Calibration output



Outputs the calibration signal used in vertical scale accuracy calibration (page 144).

Security lock slot



Standard laptop security lock slot for ensuring the security of the DSO.

Display

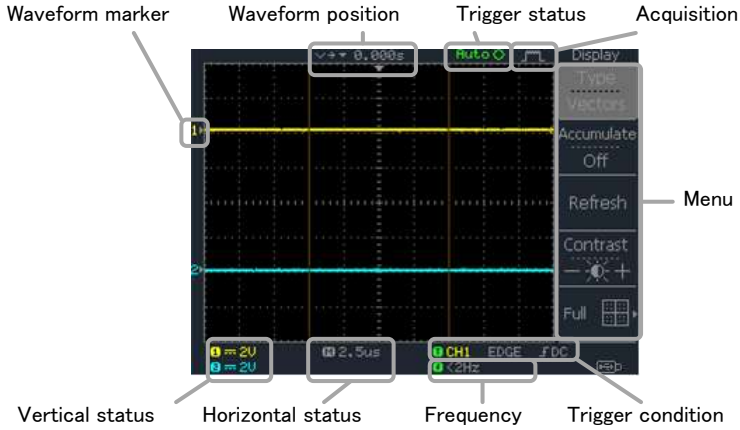

Waveforms	Channel 1: Yellow	Channel 2: Blue
Trigger status	Trig'd	A signal is being triggered
	Trig?	Waiting for a trigger condition
	Auto	Updating the input signal regardless of trigger conditions
	STOP	Triggering is stopped
	For trigger setting details, see page 108.	
Input signal frequency	Updates the input signal frequency (the trigger source signal) in real-time. “< 2Hz” Indicates that the signal frequency is less than the lower frequency limit (2Hz) and thus not accurate.	

Trigger configuration	Shows the trigger source, type, and slope. In case of the Video trigger, shows the trigger source and polarity.
Horizontal status	Shows the channel configurations: coupling mode, vertical scale, and horizontal scale.
Vertical status	

Setting up the Oscilloscope

Background This section describes how to set up the oscilloscope properly including adjusting the handle, connecting a signal, adjusting the scale, and compensating the probe. Before operating the oscilloscope in a new environment, run these steps to make sure the oscilloscope is functionally stable.

Procedure

1. Pull both bases of the handle out slightly.

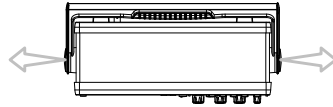

2. Turn to one of the three preset positions.

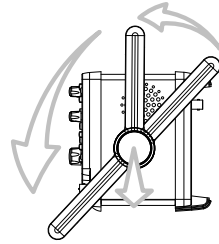

3. Connect the power cord.

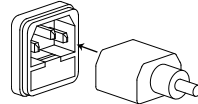

4. Press the power switch. The display will become active in approximately 10 seconds.



5. Reset the system by recalling the factory settings. Press the Save/Recall key, then Default Setup. For details regarding the factory settings, see page 57.

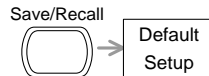

6. Connect the probe between the Channel1 input terminal and probe compensation signal output (2Vp-p, 1kHz square wave).
7. Set the probe attenuation voltage to x10.

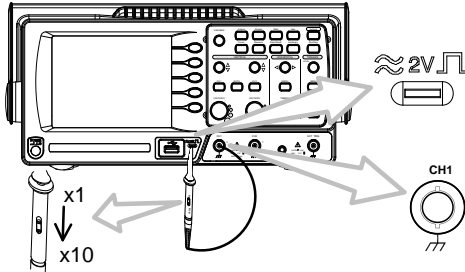

8. Press the Autoset key. A square waveform will appear in the center of the display. For details on Autoset, see page 61.



9. Press the Display key, then Type and select the vector waveform type.

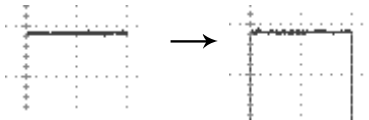
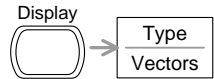

10. Turn the adjustment point on the probe to flatten the square waveform edge.

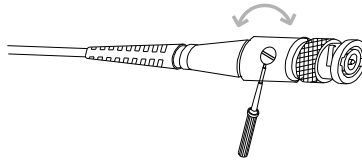
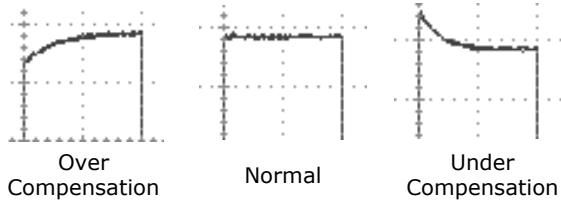



11. Setting up the oscilloscope is complete. You may continue with the other operations.

Measurement: page 60 Configuration: page 92

QUICK REFERENCE

This chapter lists the oscilloscope menu tree, operation shortcuts, built-in help coverage, and default factory settings. Use this chapter as a handy reference to access the oscilloscope functions.

Menu Tree and Shortcuts

Conventions	Examples
Normal	= Press the functional key for “Normal”
Average 	= Repeatedly press the functional key for “Average”
Normal ~ Average	= Select a menu from “Normal” to “Average” and press its functionality key
Normal → VAR 	= Press the functionality key for “Normal”, and then use the Variable knob

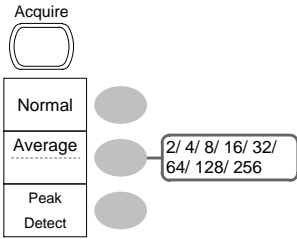

Select acquisition mode

Normal ~ Peak-Detect

Select average number

Average ↩

Turn Delay on/off



CH1/CH2 key

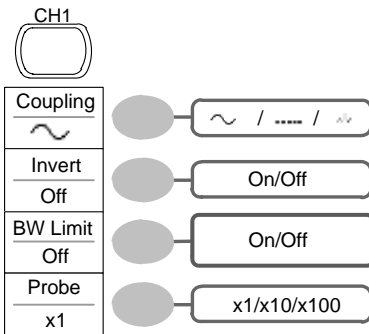

Turn channel on/off

CH 1/2 ↩

Select coupling mode

Coupling ↩

Invert waveform

Invert ↩





Turn bandwidth limit on/off

BW Limit ↩





Select probe attenuation

↔Probe

Cursor key 1/2







Cursor	
	Turn cursor on/off Cursor 
Source CH1	Move X1 cursor X1 → VAR 
X1 123.4us 212.0mV	Move X2 cursor X2 → VAR 
X2 22.9us 0.000V	Move both X1 and X2 cursor X1X2 → VAR 
X1X2 23.6us 11.9Hz 212.0mV	Switch to Y cursor X ↔ Y
X ↔ Y	

Cursor key 2/2

Cursor	
	Turn cursor on/off Cursor 
Source CH1	Move Y1 cursor Y1 → VAR 
Y1 123.4mV	Move Y2 cursor Y2 → VAR 
Y2 12.9mV	Move both Y1 and Y2 cursor Y1Y2 → VAR 
Y1Y2 10.5mV	Switch to X cursor
X ↔ Y	

X↔Y

Display key

<p>Display</p> 	<p>Type</p> <p>Vectors/ Dots</p> <p>Accumulate</p> <p>Off</p> <p>Refresh</p> <p>Contrast</p> <p>- ☹ +</p> <p>Full </p>	<p>● Vectors/ Dots</p> <p>● On/ Off</p> <p>●</p> <p>●</p> <p>●  /  / </p>	<p>Select waveform type</p> <p>Type ↵</p> <p>Waveform accumulate On/Off</p> <p>Accumulate ↵</p> <p>Refresh accumulation</p> <p>Refresh</p> <p>Set display contrast</p> <p>Contrast →VAR ⌚</p> <p>Select display grid</p> <p> ↵</p>
--	---	--	---

Autoset key

<p>Autoset</p> 	<p>Automatically find the signal and set the scale</p> <p>Autoset</p>
--	---

Hardcopy key

<p>Hardcopy</p> 	<p>→ See Utility key (page 49)</p>
---	------------------------------------

Help key



Turn help mode on/off

Help 

Horizontal menu key

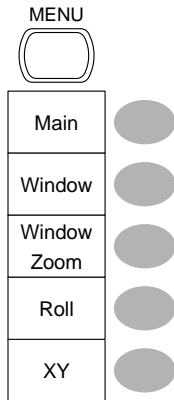

Select main (default) display

Main

Select window mode

Window → TIME/DIV

Zoom in window mode

Window Zoom

Select window roll mode

Roll

Select XY mode

XY

Math key 1/2 (+/-)

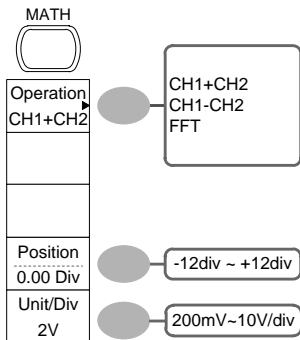

Math on/off

Math

Select math operation type (+/- /FFT)

Operation

Set result position

Position → VAR

Math result Volt/Div

Unit/Div → VAR

Math key 2/2 (FFT)

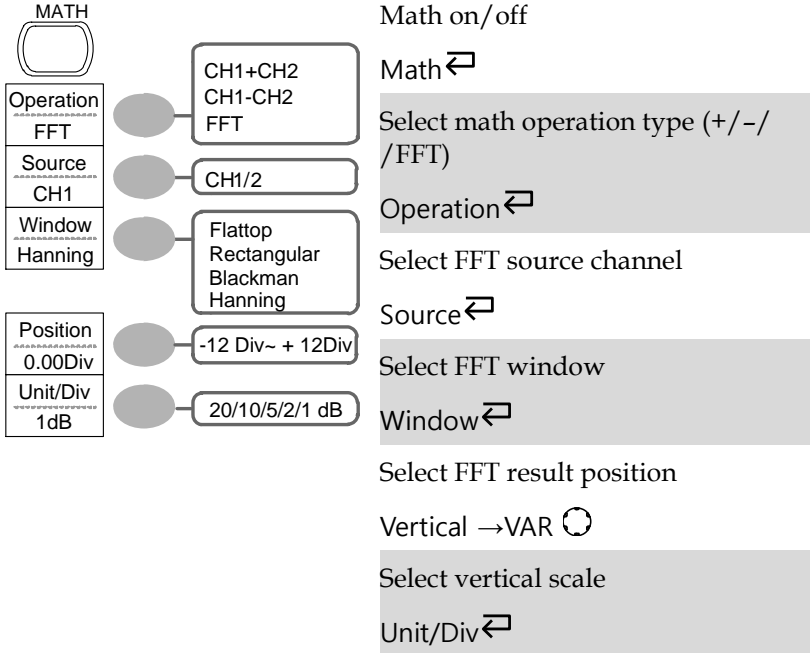

Measure key

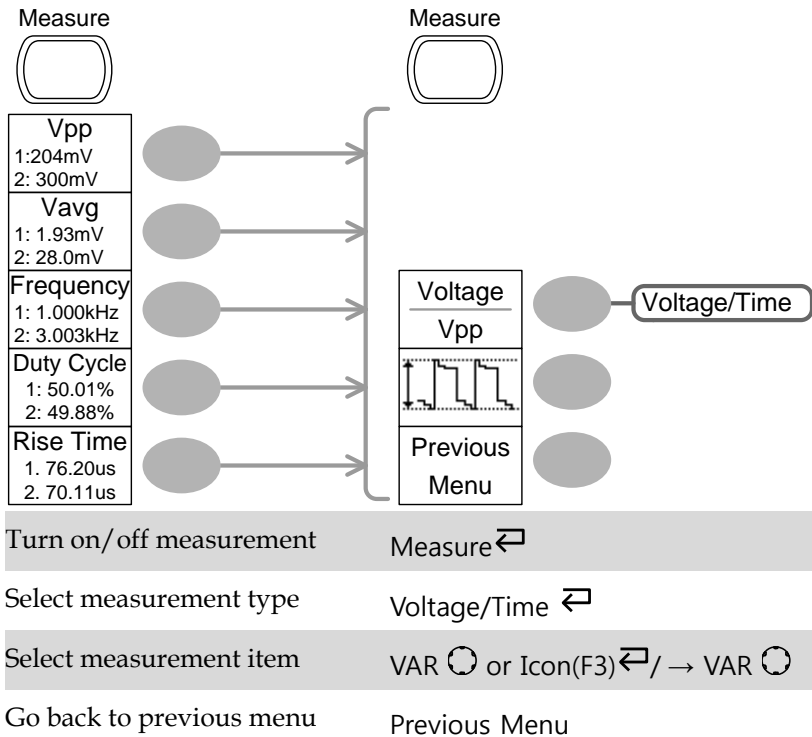

Run/Stop key

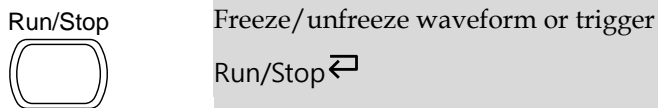

Save/Recall key 1/9

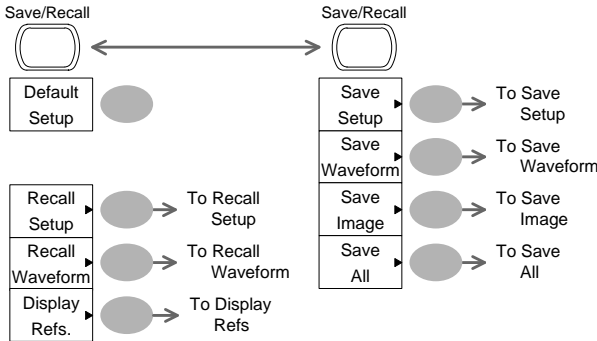

Switch to Save or Recall menu Save/Recall ↩

Recall default setup Default Setup

Save/Recall key 2/9

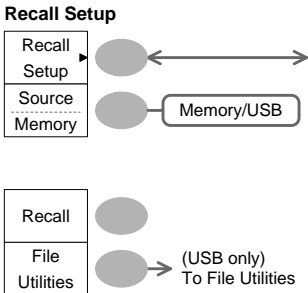

Select other menu

Recall Setup ↩

Select setup source

Source ↩ → VAR ○

Recall setup

Recall

Go to USB file utilities

File Utilities

Save/Recall key 3/9

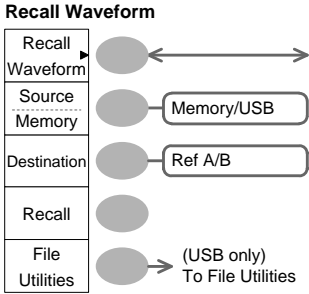

Select other menu

Recall Waveform ↩

Select waveform source

Source ↩ → VAR ○

Select waveform destination

Destination → VAR ○

Recall waveform

Recall

Go to USB file utilities

File Utilities

Save/Recall key 4/9

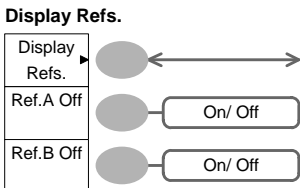

Select other menu

Display Refs. ↩

Turn ref. waveform A on/off

Ref.A ↩

Turn ref. waveform B on/off

Ref.B ↩

Save/Recall key 5/9

Save Setup

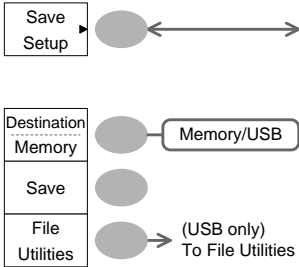

Select other menu

Save Setup \leftarrow

Select destination

Destination $\leftarrow \rightarrow$ VAR \odot

Save setup

Save

Go to USB file utilities

File Utilities

Save/Recall key 6/9

Save Waveform

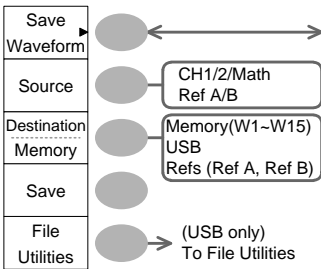

Select other menu

Save Waveform \leftarrow

Select source

Source $\leftarrow \rightarrow$ VAR \odot

Select destination

Destination $\leftarrow \rightarrow$ VAR \odot

Save waveform

Save

Go to USB file utilities

File Utilities

Save/Recall key 7/9

Save Image

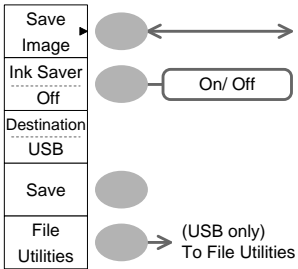

Select other menu

Save Image ↩

Turn on/off ink saver

Ink Saver ↩

Save image

Save

Go to USB file utilities

File Utilities

Save/Recall key 8/9

Save All

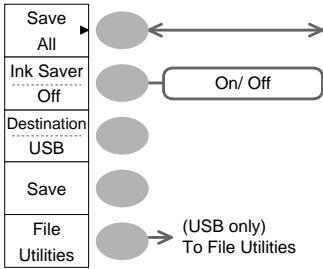

Select other menu

Save All ↩

Turn on/off ink saver

Ink Saver ↩

Select destination

Destination ↩ → VAR ○

Save all

Save

Go to USB file utilities

File Utilities

Save/Recall key 9/9

File Utilities

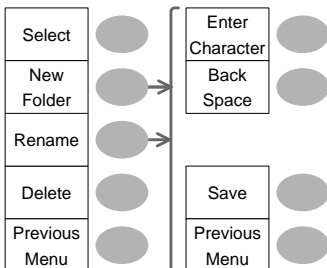

Select file/folder

VAR ○ → Select

Create or rename folder/file

New Folder/Rename

VAR ○ → Enter character /

Backspace / Save / Previous menu

Delete folder/file

Delete

Go to previous menu

[Previous menu](#)

Trigger key 1/5

Trigger Type



Type	Edge
Source	CH1

Slope / Coupling	Mode
	Auto

Select Trigger type

Type

Trigger key 2/5

Video Trigger

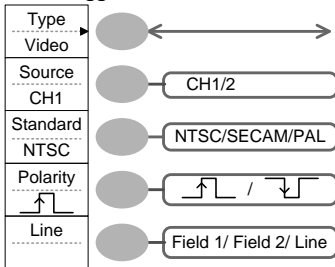

Select video trigger type

Type

Select trigger source

Source

Select video standard

Standard

Select video polarity

Polarity

Select video field/line

Line → VAR

Trigger key 3/5

Edge Trigger

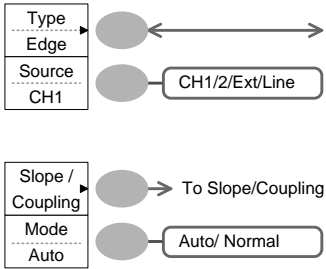

Select edge trigger type

Edge ↵

Select trigger source

Source ↵

Go to slope/coupling menu (page 49)

Slope/Coupling

Select trigger mode

Mode ↵

Trigger key 4/5

Pulse Trigger

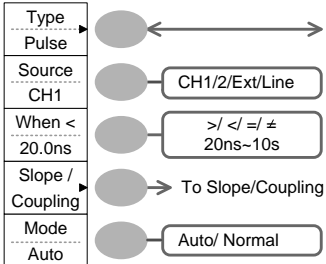

Select pulse trigger type

Type ↵

Select trigger source

Source ↵

Select pulse trigger condition and pulse width

When ↵ → VAR ○

Go to slope/coupling menu (page 49)

Slope/Coupling

Select trigger mode

Mode ↩

Trigger key 5/5

Coupling/Slope

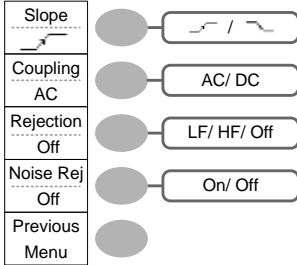

Select trigger slope type

Slope ↵

Select trigger coupling mode

Coupling ↵

Select frequency rejection

Rejection ↵

Turn noise rejection on/off

Noise Rej ↵

Go back to previous menu

Previous Menu

Utility key 1/10 (Utility #1)

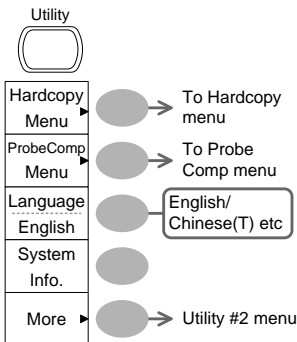

Go to hardcopy menu

Hardcopy

Go to probe compensation menu

ProbeComp

Select language

Language ↵

Show system information

System Info.

Go to the next Utility menu

More

Utility 2/10 (Utility #2)

Utility

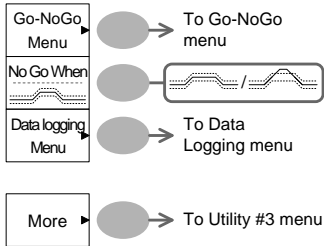

Go to the Go-NoGo menu

Go-NoGo

Set the NoGo conditions to inside
/outside limits

No Go When ↩

Go to the Data Logging Menu

Data Logging

Go to the next Utility menu

More

Utility key 3/10 (Utility #3)

Calibration



Enter self calibration

Self CAL



Go to the first Utility menu

More

Utility key 4/10 (Hardcopy -Save All)

Hardcopy

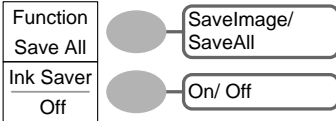

Select Hardcopy function

Function ↩

Turn on/off Ink saver

Ink Saver ↩

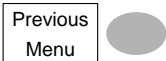

Go to previous menu

Previous Menu ↩

Utility key 5/10 (Hardcopy -Save Image)

Hardcopy- Save Image

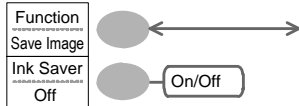

Select Hardcopy function

Function ↩

Turn on/off Inksaver

52

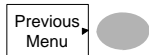

Ink Saver ↩

Go to previous menu

Previous Menu ↩

Utility key 6/10 (Probe compensation)

Probe compensation

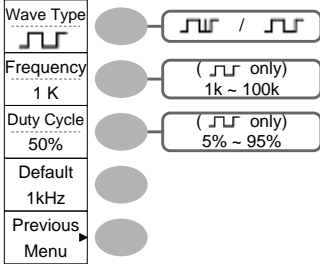

Select probe compensation signal

Wave Type \leftarrow

Set frequency for square wave

Frequency \rightarrow VAR \odot

Set duty cycle for square wave

Duty Cycle \rightarrow VAR \odot

Go to previous menu

Previous Menu

Utility key 7/10 (Go-NoGo)

Edit

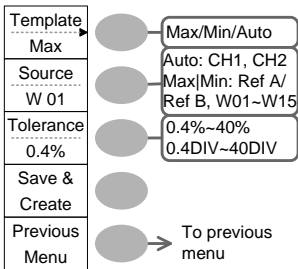

Switch between templates

Template \leftarrow

Select the template source

Source \leftarrow

Set the tolerance (% or Divisions)

Tolerance \leftarrow \rightarrow VAR \odot

Save the template

Save & Create

Go back to previous menu

Previous Menu

Utility key 8/10 (Data Logging 1/2)

Data logging

Data logging Off	●	On/Off
Source CH1	●	CH1/CH2
Setup	● →	To the Edit menu
File Utilities	● →	(USB only) To File Utilities
Previous Menu	● →	To previous menu

Turn Data Logging On/Off
Data logging ↩

Set the logging source

Source ↩

Go to the Data Logging Edit menu

Setup

Go to the File Utilities menu

File Utilities

Go back to previous menu

Previous Menu

Utility key 9/10 (Data Logging 2/2)

Edit

Save Waveform	●	Waveform/Image
Interval 2 secs	●	2 secs~2 mins
Duration 5 mins	●	5 mins~ 100hrs
Previous Menu	● →	To previous menu

Save the logs as waveform data or as image files

Save ↩

Set the logging interval

Interval →VAR ⦿

Set the duration of the record log

Duration →VAR ⦿

Go back to previous menu

Previous Menu

Utility key 10/10 (Self CAL Menu)

Self Cal.

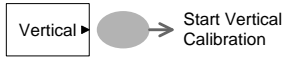



Start Vertical Calibration

Vertical

Default Settings

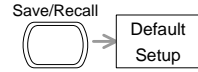
Here are the factory installed panel settings which appear when pressing the Save/Recall key → *Default Setup*.



Acquisition	Mode: Normal	
Channel	Scale: 2V/Div	Invert: Off
	Coupling: DC	Probe attenuation voltage: x1
	BW limit: Off	Channel 1 & 2: On
Cursor	Source: CH1	Cursor: Off
Display	Type: Vectors	Accumulate: Off
	Grid: Full 	
Horizontal	Scale: 2.5us/Div	Mode: Main Timebase
Math	Type: + (Add)	Position: 0.00 Div
Measure	Item: Vpp, Vavg, Frequency, Duty Cycle, Rise Time	
Trigger	Type: Edge	Source: Channel1
	Mode: Auto	Slope: 
	Coupling: DC	Rejection: Off
	Noise Rejection: Off	
Utility	Hardcopy: SaveImage, InkSaver On	ProbeComp: Square wave, 1k, 50% duty cycle
Go-NoGo	Go-NoGo: Off	Source: CH1

	When: 	Violating: Stop
Data Logging	Data logging: Off	Source: CH1
	Setup: Waveform	Interval: 2 secs
	Duration: 5 mins	

Built-in Help

The Help key shows the contents of the built-in help support. When you press a function key, its descriptions appear in the display.



Applicable keys

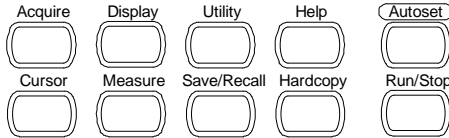

(Vertical)

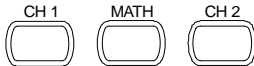

(Horizontal) (Trigger)

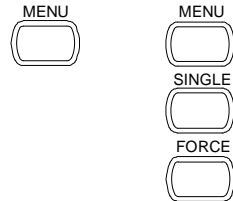

Procedure

1. Press the Help key. The display changes to the Help mode.
2. Press a functional key to access its help contents. (example: Acquire key)
3. Use the Variable knob to scroll the Help contents up and down.



4. Press the Help key again to exit the Help mode.



M MEASUREMENT

The Measurement chapter describes how to properly observe a signal using the oscilloscope's basic functions, and how to observe a signal in a detailed manner using some of the advanced functions such as:

Automatic measurements, cursor measurements, and math operations.

Basic Measurements

This section describes the basic operations required in capturing and viewing an input signal. For more detailed operations, see the following chapters.

- Measurements → from page 60
- Configuration → from page 92

Activating a channel

Activating a channel

To activate an input channel, press the Channel key, CH1 or CH2. The channel indicator appears at the left side of the display and the channel icon changes accordingly.

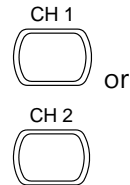

(Continued on next page)

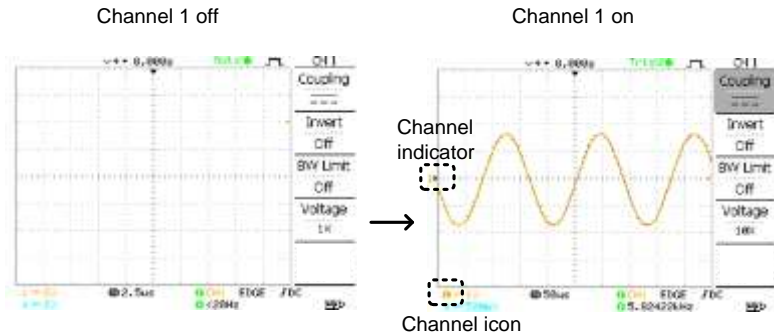

De-activating a channel To de-activate the channel, press the Channel key twice (once if the channel menu is already selected).

Using Autoset

Background The Autoset function automatically configures the panel settings to the best viewing conditions, in the following way.

- Selecting the horizontal scale
- Positioning the waveform horizontally
- Selecting the vertical scale
- Positioning the waveform vertically
- Selecting the trigger source channel
- Activating the channels

Procedure

1. Connect the input signal to the oscilloscope and press the Autoset key.



2. The waveform appears in the center of the display.

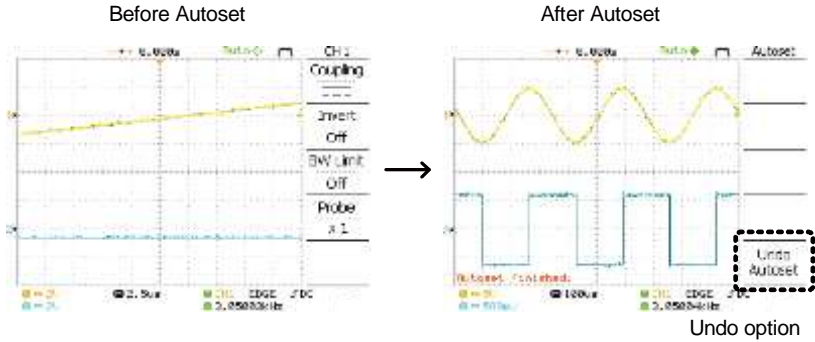

Undoing the Autoset

To undo the Autoset, press *Undo* (available for a few seconds).



Adjusting the trigger level

If the waveform is still unstable, try adjusting the trigger level up or down by using the Trigger Level knob.



Limitation

Autoset does not work in the following situation.

- Input signal frequency less than 20Hz
- Input signal amplitude less than 30mV

Running and stopping the trigger

Background

In the trigger Run mode, the oscilloscope constantly searches for a trigger condition and updates the signal onto the display when the condition is met.

In the trigger Stop mode, the oscilloscope stops triggering and thus the last acquired waveforms stay in the display. The trigger icon at the top of the display changes into Stop mode.

Pressing the Trigger Run/Stop key switches between the Run and Stop mode.



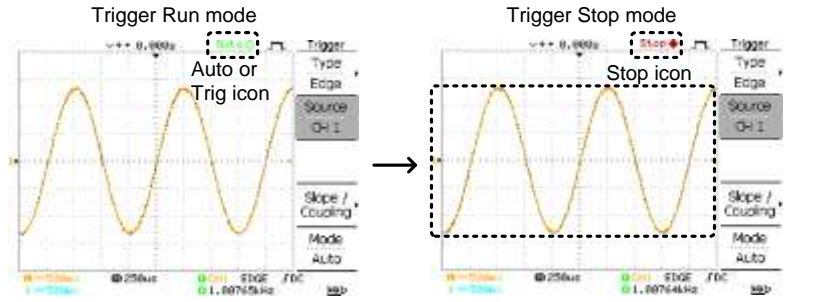

Waveform operation

Waveforms can be moved or scaled in both the Run and Stop mode. For details, see page 99 (Horizontal position/scale) and page 106 (Vertical position/scale).

Changing the horizontal position and scale

For more detailed configurations, see page 99.

Setting the horizontal position

The horizontal position knob moves the waveform left or right.

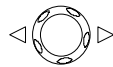

The position indicator moves along with the waveform and the distance from the center point is displayed as the offset in the upper side of the display.

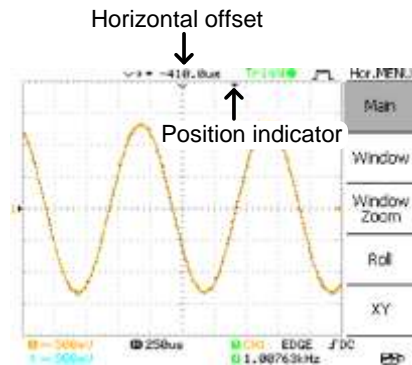

Selecting the horizontal scale To select the timebase (scale), turn the TIME/DIV knob; left (slow) or right (fast).



Range 1ns/Div ~ 10s/Div, 1-2.5-5 increment

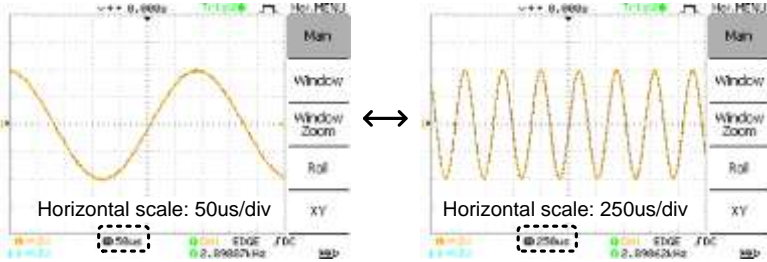

Changing the vertical position and scale

For more detailed configuration, see page 106.

Set vertical position To move the waveform up or down, turn the vertical position knob for each channel.



As the waveform moves, the vertical position of the cursor appears at the bottom left corner of the display.

Run/Stop mode The waveform can be moved vertically in both Run and Stop mode.

Select vertical scale To change the vertical scale, turn the VOLTS/DIV knob; left (down) or right (up).



Range 2mV/Div ~ 10V/Div, 1-2-5 increments

The vertical scale indicator for each channel on the bottom left of the display changes accordingly.

Using the probe compensation signal

Background This section introduces how to use the probe compensation signal for general usage, in case the DUT signal is not available or to get a second signal for comparison. For probe compensation details, see page 145.



Note: The frequency accuracy and duty factor are not guaranteed. Therefore the signal should not be used for reference purposes.

Waveform type



Square waveform used for probe compensation. 1k ~ 100kHz, 5% ~ 95%.



Demonstration signal for showing the effects of peak detection. See page 92 for peak detection mode details.

View the probe compensation waveform

1. Connect the probe between the compensation signal output and Channel input.

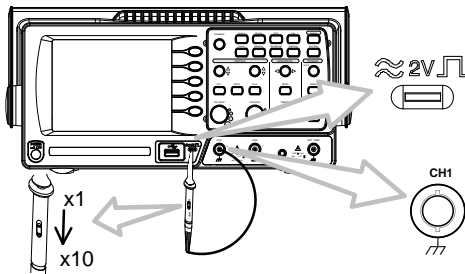

2. Press the Utility key.



3. Press *ProbeComp*.



4. Press Wave type repeatedly to select the wave type.

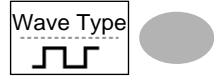

5. (For \square only) To change the frequency, press *Frequency* and use the Variable knob.

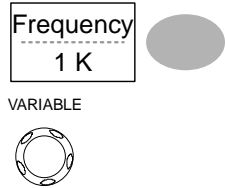

Range 1kHz ~ 100kHz

6. (For \square only) To change the duty cycle, press *Duty Cycle* and use the Variable knob.

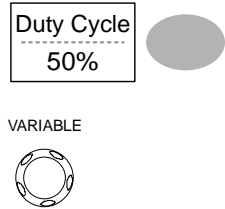

Range 5% ~ 95%























Probe compensation















For probe compensation details, see page 145.

Automatic Measurements

The automatic measurement function measures input signal attributes and updates them in the display. Up to 5 automatic measurement items can be updated at any one time on the side menus. All automatic measurement types can be displayed on screen if necessary.

Measurement items

Overview	Voltage type	Time type
	Vpp 	Frequency 
	Vmax 	Period 
	Vmin 	RiseTime 
	Vamp 	FallTime 
	Vhi 	+ Width 
	Vlo 	- Width 
	Vavg 	Dutycycle 
	Vrms 	
	ROVShoot 	
	FOVShoot 	
	RPREShoot 	
	FPREShoot 	
Voltage measurement items	Vpp 	Difference between positive and negative peak voltage (=Vmax - Vmin)
	Vmax 	Positive peak voltage.
	Vmin 	Negative peak voltage.

	Vamp		Difference between global high and global low voltage (=Vhi - Vlo)
	Vhi		Global high voltage.
	Vlo		Global low voltage.
	Vavg		Averaged voltage of the first cycle.
	Vrms		RMS (root mean square) voltage.
	ROVShoot		Rise overshoot voltage.
	FOVShoot		Fall overshoot voltage.
	RPREShoot		Rise preshoot voltage.
	FPREShoot		Fall preshoot voltage.
Time measurement items	Freq		Frequency of the waveform.
	Period		Waveform cycle time (=1/Freq).
	Risetime		Rising time of the pulse (~90%).
	Falltime		Falling time of the pulse (~10%).
	+Width		Positive pulse width.
	-Width		Negative pulse width.

Duty Cycle  Ratio of signal pulse
compared with whole cycle
=100x (Pulse Width/Cycle)

Automatically measuring the input signals

Viewing the measurement result

1. Press the Measure key.



2. The measurement results appear on the menu bar, constantly updated. 5 measurement slots (F1 to F5) can be customized.

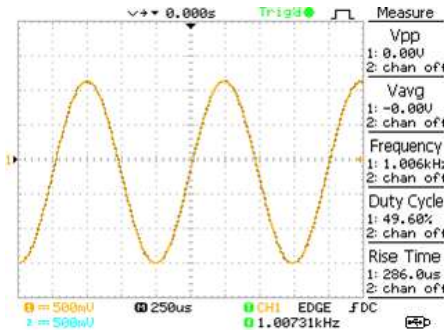

Selecting a measurement item

3. Press F3 repeatedly to select the measurement type: Voltage or Time.

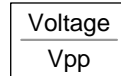

4. Use the Variable knob to select the measurement item.

VARIABLE

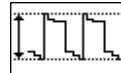

5. Press Previous Menu to confirm the item selection and to go back to the measurement results view.

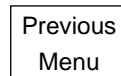

Cursor Measurements





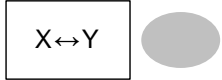
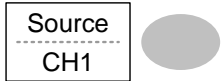

Cursor line, horizontal or vertical, shows the precise position of the input waveforms or the math operation results. The horizontal cursor can track time, voltage and frequency, whilst the vertical cursor can track voltage.

Using the horizontal cursors

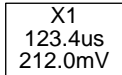

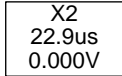

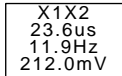
- | | |
|-----------|--|
| Procedure | <ol style="list-style-type: none"> 1. Press the Cursor key. The cursors appear in the display.  2. Press X↔Y to select the horizontal (X1&X2) cursor.  3. Press Source repeatedly to select the source channel.  |
| | <p style="text-align: center;">Range CH1, 2, MATH</p> |
| | <ol style="list-style-type: none"> 4. The cursor measurement results will appear in the menu, F2 to F4. |

Parameters	<table border="0"> <tr> <td>X1</td> <td>Time position of the left cursor. (relative to zero)</td> </tr> <tr> <td>X2</td> <td>Time position of the right cursor. (relative to zero)</td> </tr> <tr> <td>X1X2</td> <td>The difference between the X1 and X2.</td> </tr> <tr> <td>-uS</td> <td>The time difference between X1 and X2.</td> </tr> <tr> <td>-Hz</td> <td>The time distance converted to frequency.</td> </tr> </table>	X1	Time position of the left cursor. (relative to zero)	X2	Time position of the right cursor. (relative to zero)	X1X2	The difference between the X1 and X2.	-uS	The time difference between X1 and X2.	-Hz	The time distance converted to frequency.
X1	Time position of the left cursor. (relative to zero)										
X2	Time position of the right cursor. (relative to zero)										
X1X2	The difference between the X1 and X2.										
-uS	The time difference between X1 and X2.										
-Hz	The time distance converted to frequency.										



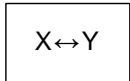

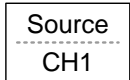

-V The voltage difference. (X1-X2)

Moving the horizontal cursors	To move the left cursor, press X1 and then use the Variable knob.		
	To move the right cursor, press X2 and then use the Variable knob.		
	To move both cursors at once, press X1X2 and then use the Variable knob.		
Remove cursors	Press Cursor to remove the onscreen cursors.		

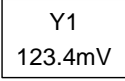
Using the vertical cursors

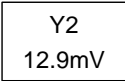
Procedure	1. Press the Cursor key.		
	2. Press X↔Y to select the vertical (Y1&Y2) cursor.		
	3. Press Source repeatedly to select the source channel.		
	Range CH1, 2, MATH		
	4. The cursor measurement results will appear in the menu.		

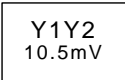
Parameters	Y1	Voltage level of the upper cursor
	Y2	Voltage level of the lower cursor

	Y1Y2	The difference between the upper and lower cursor
Moving the vertical cursors	To move the upper cursor, press Y1 and then use the Variable knob.	 
	To move the lower cursor, press Y2 and then use the Variable knob.	 
	To move both cursors at once, press Y1Y2 and then use the Variable knob.	 
Remove cursors	Press Cursor to remove the onscreen cursors.	

Math Operations





The Math operations can add, subtract, or perform FFT on the input waveforms. The resulted waveform can be measured using the cursors, and saved or recalled just like normal input signals.

Overview

Addition (+)	Adds the amplitude of CH1 & CH2 signals.	
Subtraction (-)	Extracts the amplitude difference between CH1 & CH2.	
FFT	Performs a FFT calculation on a signal. Four types of FFT windows are available: Hanning, Flattop, Rectangular, and Blackman.	
Hanning FFT window	Frequency resolution	Good
	Amplitude resolution	Not good
	Suitable for...	Frequency measurement on periodic waveforms
Flattop FFT window	Frequency resolution	Not good
	Amplitude resolution	Good
	Suitable for...	Amplitude measurement on periodic waveforms
Rectangular FFT window	Frequency resolution	Very good

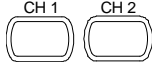
	Amplitude resolution	Bad
	Suitable for...	Single-shot phenomenon (this mode is the same as having no window at all)
Blackman FFT window	Frequency resolution	Bad
	Amplitude resolution	Very good
	Suitable for...	Amplitude measurement on periodic waveforms

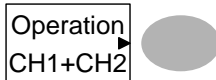
Adding, subtracting or multiplying signals

Procedure	1. Activate both CH1 and CH2.	
	2. Press the Math key.	
	3. Press Operation repeatedly to select addition (+) or subtraction (-).	
	4. The math measurement result appears in the display.	

5. To move the math result vertically, use the Variable knob. The position will be displayed in Position.

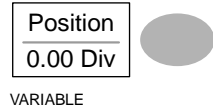

VARIABLE



6. To clear the math result from the display, press the Math key again.



Using the FFT function

Procedure

1. Press the Math key.



2. Press Operation repeatedly to select FFT.



3. Press Source repeatedly to select the source channel.

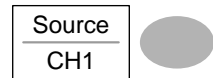

4. Press Window repeatedly to select the FFT window type.

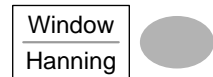

5. The FFT result appears. The horizontal scale changes from time to frequency, and the vertical scale from voltage to dB.

6. To move the FFT waveform vertically, press Position and use the Variable knob.

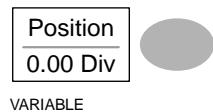

VARIABLE



Range -12.00 Div ~ +12.00 Div

7. To select the vertical scale of FFT waveform, press Unit/Div repeatedly.

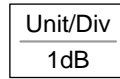

Range 1, 2, 5, 10, 20 dB/Div

8. To clear the FFT result from the display, press the Math key again.







Go No-Go Testing

Overview

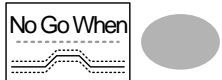
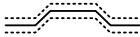

Background Go-NoGo testing checks if a waveform conforms to a user-specified maximum and minimum boundary (template). The testing can be set to stop or continue each time the template has or has not been violated by the input waveform.

Settings	Item	Default	Details
	NoGo criteria: When inside or outside the boundary	Inside	Page 80
	Source	Channel 1	Page 80
	Test continue or stop when NoGo occurs	Stop	Page 82
	Boundary (template) – selects the minimum and maximum boundaries (template) from a single waveform	Auto (0.4%)	Page 82
	Run Tests		Page 87

Edit: NoGo When

- | | | |
|-----------|---|---|
| Procedure | 1. Press the Utility key. |  |
| | 2. Press the <i>More</i> key. |  |
| | 3. Press <i>No Go When</i> repeatedly to select the NoGo conditions. |  |
| |  | NoGo when the waveform is inside the boundary (template) |
| |  | NoGo when the waveform is outside of the boundary (template) |

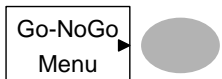

Edit: Source

- | | | |
|-----------|--------------------------------|---|
| Procedure | 1. Press the Utility key. |  |
| | 2. Press the More key. |  |
| | 3. Press the Go-NoGo Menu key. |  |

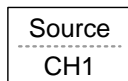
4. Press Source repeatedly to select the source channel (CH1 or CH2).

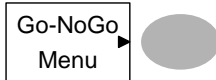
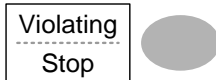

Edit: NoGo Violation Conditions

Procedure	1. Press the Utility key.	
	2. Press the <i>More</i> key.	
	3. Press the <i>Go-NoGo Menu</i> key.	
	4. Press Violating repeatedly to select the NoGo conditions.	
	Stop	Stops the test when the NoGo conditions have been met.
	Continue	The tests continue even when the NoGo conditions have been met.

Edit: Template (boundary)

Background	The NoGo template sets the upper and lower amplitude boundary. Two methods are available: Min/Max and Auto.	
	Min/Max	Selects the upper boundary (Max) and lower boundary (Min) as separate waveforms, from the internal memory. The upper boundary is saved to Ref A, the lower boundary is saved to Ref. B.

Advantage: The template shape and distance (allowance) between the source signal are fully customizable.

Disadvantage: The waveforms (templates) have to be stored internally prior to this selection.

Auto

Creates the upper and lower boundary (template) from the source signal, not from an internally stored waveform.

Advantage: No need to store the waveforms prior to this selection.

Disadvantage: The template shape is proportional to the source signal. The distance (allowance) between the source signal and the upper and lower template is the same.

Max/Mix

1. The template is based on the source signal. Ensure the source signal appears on the display.

2. Press the Utility key.



3. Press the *More* key.



4. Press the *Go-NoGo Menu* key.

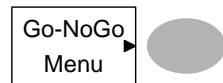

5. Press the *Template Edit* key.



- 6. Press *Template* repeatedly to select the upper (Max) or lower (Min) boundaries.

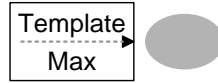

- 7. Press *Source* and use the Variable knob to select the waveform template.

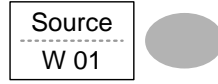

VARIABLE



Max

Waveform A: Ref A, W01~W15

Min

Waveform B: Ref B, W01~W15

- 8. Press *Position* and use the Variable knob to set the waveform amplitude.

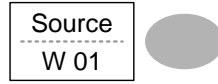

VARIABLE



- 9. Repeat steps 5-7 for the other template setting (Max or Min).

- 10. When both Max and Min templates have been configured, press *Save & Create* to save the templates.



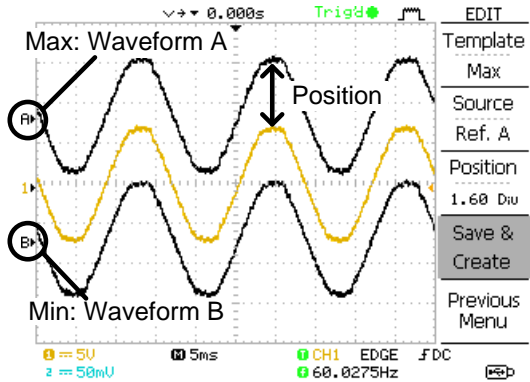

Auto

1. The template is based on the source signal. Ensure the source signal appears on the display.

2. Press the Utility key.



3. Press the More key.



4. Press the Go-NoGo Menu key.

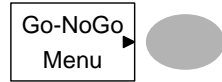

5. Press the Template Edit key.



6. Press *Template* repeatedly to select the Auto template.

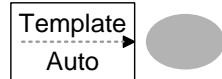

7. Press *Source* and use the Variable knob to select the template source.

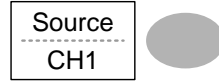

VARIABLE



Source CH1, CH2

8. Press *Tolerance* repeatedly to choose the tolerance units, % or Div. Use the Variable knob to set the tolerance. The tolerance is for both the horizontal and vertical axis.

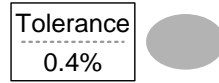

VARIABLE



% 0.4% ~ 40.0%

Div 0.04 Div ~ 4.0 Div

9. When the Auto template has been configured, press *Save & Create* to save the template.

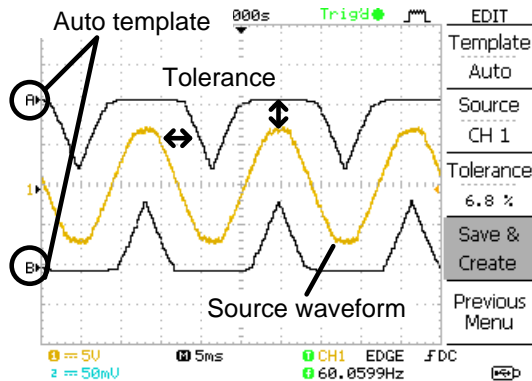
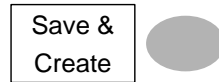

Run Go-NoGo Tests

Procedure

1. Press the Utility key.



2. Press the *More* key.



3. Press the *Go-NoGo Menu* key.

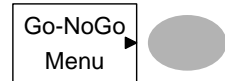

Ensure the source signal and boundary templates appear on the screen.

4. Press *Go-NoGo*. The test starts and stops according to the conditions set on page 80, 82. To stop the test that has already started, press *Go-NoGo* again.

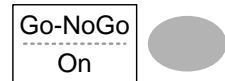

5. The test results appear in the Ratio soft-key. The numerator denotes the total number of failed tests. The denominator denotes the total number of tests.

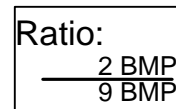

Numerator Number of "failed" tests.



Denominator Total number of tests.

Data Logging

Overview

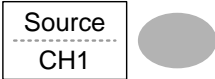

Background	<p>The Data logging function allows you to log data or a screen image over timed intervals for up to 100 hours to a USB flash drive.</p> <p>The data or images are stored to a USB flash drive in a directory named LogXXXX. LogXXXX is incremented each time the data logging function is used.</p> <p>The files saved in the LogXXXX directory are named DSXXXX.CSV, or DSXXXX.BMP for data or image files, respectively. At each timed interval data or an image file is saved and the file number incremented. For example, DS0000 is the first logged data, DS0001 is the second and so on.</p>
------------	--

Edit: Source

Procedure	1. Press the Utility key.	
	2. Press the <i>More</i> key.	
	3. Press the <i>Data logging Menu</i> key.	
	4. Press Source repeatedly to select the source channel (CH1 or CH2).	

Edit: Setup Parameters

Background The logging function must set the type of data that will be logged (waveform/image), the capture interval time and the duration of the data logging.

Procedure	1. Press the Utility key.	
	2. Press the <i>More</i> key.	
	3. Press the <i>Data logging Menu</i> key.	

4. Press the *Setup* key.



5. Press *Save* repeatedly to log data or screen images.



6. Press *Interval* and use the Variable knob to select the interval time.



VARIABLE



Interval time	2 secs~ 2min (duration = 5 min)
	2 secs~ 5 min (duration 5~ 30 min)
	2 secs~ 30 min (duration 30+ min)

7. Press *Duration* and use the Variable knob to set the duration time.



VARIABLE



Duration 5 mins ~ 100 hours

8. Press Previous menu to return to the Data logging menu. Data logging is now ready to begin.

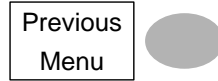

Run Data logging

Background Ensure the data source (page 89) and data logging setup has been set (page 89).

Procedure

1. Insert a USB flash drive into the USB front panel port.



2. Press the Utility key.



3. Press the *More* key.



4. Press the *Data logging Menu* key.



5. Press *Data logging* to turn data logging On. Data/image files start logging to the USB flash drive automatically. To stop the Data logging, press the *Data logging* key again.



C ONFIGURATION

The Configuration chapter describes how to configure panel settings to make measurements and observations suited to the application needs.

Acquisition

The acquisition process samples the analog input signals and converts them into digital format for internal processing. You may select the normal, average, or peak detect acquisition mode.

Selecting the acquisition mode

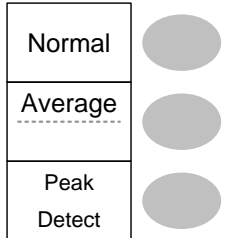
Procedure	1. Press the Acquire key.	
	2. Select the acquisition mode between <i>Normal</i> , <i>Average</i> and <i>Peak Detect</i> .	
Range	Normal	All of the acquired data is used to draw the waveform.

Average	Multiple data is averaged to form a waveform. This mode is useful for drawing a noise-free waveform. To select the number, press <i>Average</i> repeatedly.
	Average number: 2, 4, 8, 16, 32, 64, 128, 256
Peak detect	To activate the Peak detect mode, press <i>Peak-Detect</i> . Only the minimum and maximum value pairs for each acquisition interval (bucket) are used. This mode is useful for catching abnormal glitches in a signal.

Peak detect effect using the probe comp. waveform

1. One of the probe compensation waveforms can demonstrate the peak detection mode. Connect the probe to the probe compensation output.



2. Press the Utility key.



3. Press *ProbeComp*.

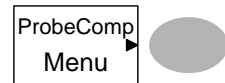

4. Press *Wave Type* and select the $\square\sqcap$ waveform.



5. Press the Autoset key. The oscilloscope positions the waveform in the center of the display.



6. Press the Acquire key.



7. Press *Normal*.



8. Press *Peak-Detect* and see that a spike noise is captured.

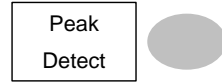

Example

The peak detect mode reveals the occasional glitch.

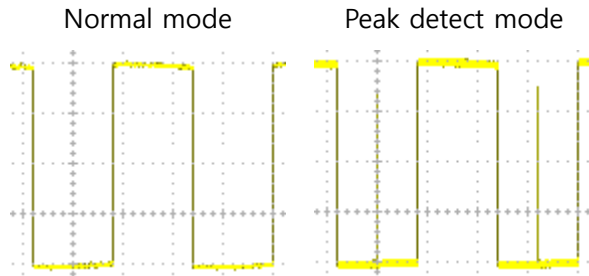



Real time vs Equivalent time sampling mode

Backgrounds	The oscilloscope automatically switches between two sampling modes, Real-time and Equivalent-time, according to the number of active channels and sampling rate.
Real-time sampling	One sampled data is used to reconstruct a single waveform. Short-time events might get lost if the sampling rate gets too high. This mode is used when the sampling rate is relatively low (250MSa/s or lower).
Equivalent-time sampling	Multiple numbers of sampled data are accumulated to reconstruct a single waveform. Restores greater waveform details but takes longer to update the waveform. This mode is used when the sampling rate becomes higher than 250MSa/s. The maximum equivalent-time sampling rate is 25GSa/s.

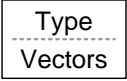

Display

The Display section describes how to configure the display settings: drawing type, waveform accumulation, contrast adjustment, and grid settings.

Selecting vector or dot drawing

Procedure	1. Press the Display key.	
	2. Press <i>Type</i> repeatedly to select the waveform drawing.	 
Types	Dots	Only the sampled dots are displayed.
	Vectors	The sampled dots are connected by lines.

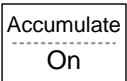
Accumulating the waveform

Background	Accumulation preserves the old waveform drawings and overwrites new waveforms on top of it. It is useful for observing waveform variation.	
Procedure	1. Press the Display key.	
	2. Press <i>Accumulate</i> on the waveform accumulation.	 

- To clear the accumulation and start it over (refresh), press *Refresh*.



Example

Accumulation off

Accumulation on

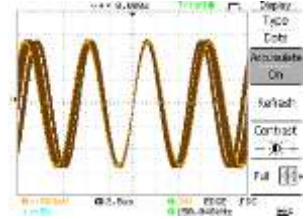
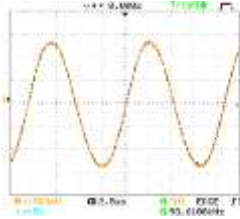

Adjusting the display contrast

Procedure

- Press the Display key.
- Press *Contrast*.

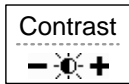

Turn the Variable knob left to lower the contrast (dark display) or right to raise the contrast (bright display).

VARIABLE



Selecting the display grid

Procedure

- Press the Display key.



2. Press the grid icon repeatedly to select the grid.

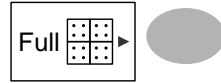

Parameters



Shows the full grid.



Shows the outer frame and X/Y axis.



Shows only the outer frame.

Horizontal View

The Horizontal view section describes how to configure the horizontal scale, position, waveform update mode, window zoom, and X-Y mode.

Moving the waveform position horizontally

Procedure

The horizontal position knob moves the waveform left or right. The position indicator at the top of the display shows the center and current position.

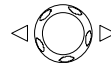

Center position

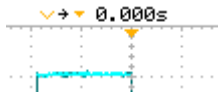

Moving right

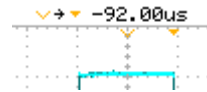

Selecting the horizontal scale

Select

horizontal scale

To select the timebase (scale), turn the TIME/DIV knob; left (slow) or right (fast).

TIME/DIV



Range 1ns/Div ~ 50s/Div, 1-2.5-5-10
increment

The timebase indicator at the bottom of the display updates the current horizontal scale.

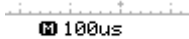
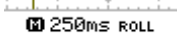

Selecting the waveform update mode

Background	The display update mode is switched automatically or manually according to the horizontal scale.	
Main mode	<p>Updates the whole displayed waveform at once. The main mode is automatically selected when the horizontal scale (timebase) is fast.</p> <p>Horizontal scale $\leq 100\text{ms}/\text{div}$</p> <p>Trigger All modes available</p>	
Roll mode	<p>Updates and moves the waveform gradually from the right side of the display to the left. The Roll mode is automatically selected when the horizontal scale (timebase).</p> <p>When in the Roll mode, an indicator appears at the bottom of the display.</p> <div style="display: flex; justify-content: space-around; align-items: flex-end;"> <div style="text-align: center;"> <p>Main mode</p>  <p>100µs</p> </div> <div style="text-align: center;"> <p>Roll mode</p>  <p>250ms ROLL</p> </div> </div> <p>Timebase $\geq 50\text{ms}/\text{div}$ ($\leq 5\text{kS}/\text{s}$)</p> <p>Trigger Auto mode only</p>	

Selecting the Roll mode manually

1. Press the Horizontal menu key.



2. Press *Roll*. The horizontal scale automatically becomes 50ms/div and the waveform starts scrolling from the right side of the display (If the oscilloscope is already in the Roll mode, there will be no change).

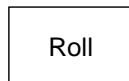

Zooming the waveform horizontally

Procedure/
range

1. Press the Horizontal Menu key.



2. Press *Window*.



3. Use the horizontal position knob to move the zoom range sideways, and TIME/DIV knob to change the zoom range width.

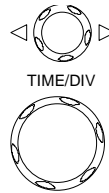

The width of the bar in the middle of the display is the actual zoomed area.

Zoom range 1ns ~ 25s

4. Press *Window Zoom*. The specified range gets zoomed.

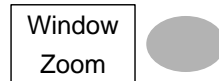

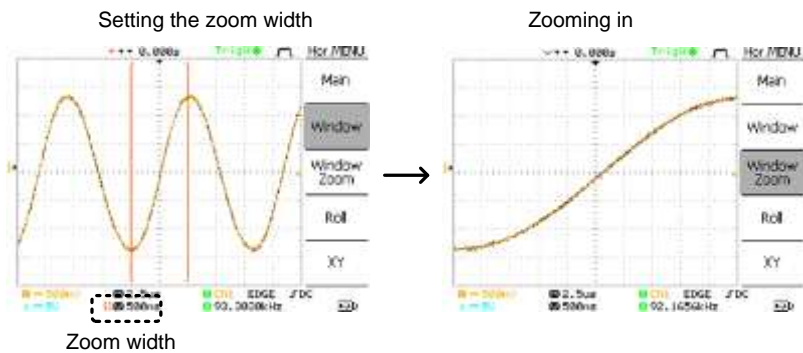

Example

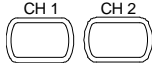

Viewing waveforms in the X-Y mode

Background The X-Y mode compares the voltage of Channel 1 and Channel 2 waveforms in a single display. This mode is useful for observing the phase relationship between the two waveforms.

- Procedure**
1. Connect the signals to Channel 1 (X-axis) and Channel 2 (Y-axis). 
 2. Make sure both Channel 1 and 2 are activated. 
 3. Press the Horizontal key. 
 4. Press XY. The display shows two waveforms in X-Y format; Channel 1 as X-axis, Channel 2 as Y-axis. 

Adjusting the X-Y mode waveform	Horizontal position	CH1 Position knob
	Horizontal scale	CH1 Volts/Div knob
	Vertical position	CH2 Position knob
	Vertical scale	CH2 Volts/Div knob

Example

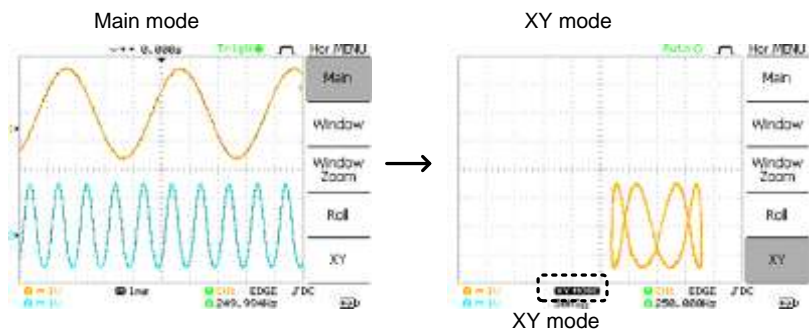

Vertical View (Channel)

The Vertical view section describes how to set the vertical scale, position, bandwidth limitation, coupling mode, and attenuation.

Moving the waveform position vertically

Procedure To move the waveform up or down, turn the vertical position knob for each channel. 



Selecting the vertical scale

Procedure To change the vertical scale, turn the VOLTS/DIV knob; left (down) or right (up). 

Range 2mV/Div ~ 10V/Div, 1-2-5 increments

Selecting the coupling mode

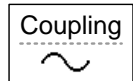
Procedure

1. Press the Channel key. 
2. Press *Coupling* repeatedly to select the coupling mode.  

Range  DC coupling mode. The whole portion (AC and DC) of the signal appears on the display.



Ground coupling mode. The display shows only the zero voltage level as a horizontal line. This mode is useful for measuring the signal amplitude with respect to the ground level.



AC coupling mode. Only the AC portion of the signal appears on the display. This mode is useful for observing AC waveforms mixed with DC components.

Inverting the waveform vertically

Procedure

1. Press the Channel key.



2. Press *Invert*. The waveform becomes inverted (upside down) and the Channel indicator in the display shows a down arrow.

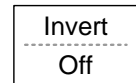

Original

Inverted

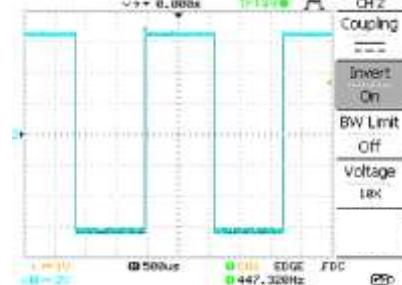
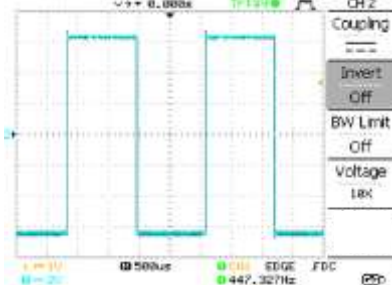

Limiting the waveform bandwidth

Background Bandwidth limitation puts the input signal into a 20MHz (-3dB) low-pass filter. This function is useful for cutting off high frequency noise to see the clear waveform shape.

Procedure

1. Press the Channel key.



2. Press *BW Limit* to turn on or off the limitation. When turned on, the BW indicator appears next to the Channel indicator in the display.

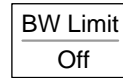

1 = 5V
2 = 200mV^{ns}

Example

BW Limit Off

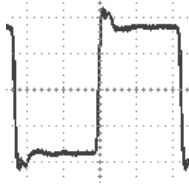

BW Limit On

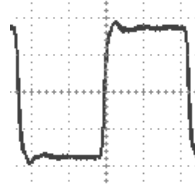

Selecting the probe attenuation level

Background A signal probe has an attenuation switch to lower the original DUT signal level to the oscilloscope input range, if necessary. The probe attenuation selection adjusts the vertical scale so that the voltage level on the display reflects the real value, not the attenuated level.

Procedure

1. Press the Channel key.



2. Press Probe repeatedly to select the attenuation level.

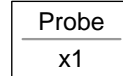

3. The voltage scale in the channel indicator changes accordingly. There is no change in the waveform shape.

Range	x1, x10, x100
Note	The attenuation factor adds no influence on the real signal; it only changes the voltage scale on the display.

Trigger

The Trigger function configures the conditions by which the oscilloscope captures the incoming signals.

Trigger type

Edge	Triggers when the signal crosses an amplitude threshold in either a positive or negative slope.
Video	Extracts a sync pulse from a video format signal and triggers on a specific line or field.
Pulse	Triggers when the pulse width of the signal matches the trigger settings.

Indicators	Edge/Pulse	Video
	(CH1, Edge, Rising edge, DC coupling)	(CH1, Video, Positive polarity, NTSC standard)

Trigger parameter

Trigger source	CH1, 2	Channel 1, 2 input signals
	Line	AC mains signal
	Ext	External trigger input signal

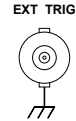

Trigger mode	Auto	The oscilloscope updates the input signal regardless of the trigger conditions (if there is no trigger event, the oscilloscope generates an internal trigger). Select this mode especially when viewing rolling waveforms at a slow timebase.
--------------	------	---

The Auto trigger status appears in the upper right corner of the display.

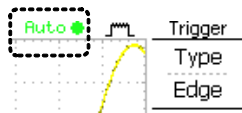

Single	The oscilloscope acquires the input signals once when a trigger event occurs, then stops acquiring. Pressing the Single key again will repeat the process.
--------	--







The Single trigger status appears in the upper right corner of the display.



Normal	The oscilloscope acquires and updates the input signals only when a trigger event occurs.
--------	---

The Normal trigger status appears in the upper right corner of the display.





Video standard (video trigger)	NTSC PAL SECAM	National Television System Committee Phase Alternative by Line SEquential Couleur A Mémoire
Sync polarity (video trigger)	 	Positive polarity Negative polarity
Video line (video trigger)	field line	Selects the trigger point in the video signal. 1 or 2 1~263 for NTSC, 1~313 for PAL/SECAM
Pulse condition (pulse trigger)	> <	Longer than = Equal to Shorter than ≠ Not equal to
Trigger slope	 	Triggers on the rising edge. Triggers on the falling edge.
Trigger coupling	AC DC	Triggers only on AC component. Triggers on AC+DC component.
Frequency rejection	LF HF	Puts a high-pass filter and rejects the frequency below 50kHz. Puts a low-pass filter and rejects the frequency above 50kHz.

Noise rejection Rejects noise signals.

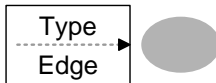
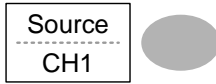

Trigger level  Using the trigger level knob moves the trigger point up or down.

Configuring the edge trigger

- Procedure
- Press the Trigger menu key. 
 - Press *Type* repeatedly to select edge trigger. 
 - Press *Source* repeatedly to select the trigger source. 

Range Channel 1, 2, Line, Ext
 - Press *Mode* repeatedly to select the Auto or Normal trigger mode. To select the single trigger mode, press the Single key. 

Range Auto, Normal

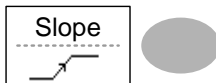
 - Press *Slope/coupling* to enter into the trigger slope and coupling selection menu. 
 - Press *Slope* repeatedly to select the trigger slope, rising or falling edge. 

Range Rising edge, falling edge

7. Press *Coupling* repeatedly to select the trigger coupling, DC or AC.

Coupling

AC



Range DC, AC

8. Press *Rejection* to select the frequency rejection mode.

Rejection

Off



Range LF, HF, Off

9. Press *Noise Rej* to turn the noise rejection on or off.

Noise Rej

Off



Range On, Off

10. Press *Previous* menu to go back to the previous menu.

Previous

Menu



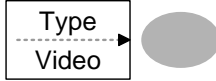
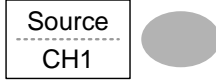

Configuring the video trigger

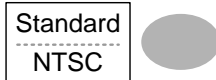
- Procedure
- Press the Trigger menu key. 
 - Press *Type* repeatedly to select video trigger. The video trigger indicator appears at the bottom of the display. 
 - Press *Source* repeatedly to select the trigger source channel. 

Range Channel 1, 2
 - Press *Standard* repeatedly to select the video standard. 

Range NTSC, PAL, SECAM
 - Press *Polarity* repeatedly to select the video signal polarity. 

Range positive, negative
 - Press *Line* repeatedly to select the video field line. Use the Variable knob to select the field. 

VARIABLE 

Field NTSC: 1 ~ 262 (Field 2), 1 ~ 263 (Field 1) PAL/SECAM: 1 ~ 312 (Field 2), 1 ~ 313 (Field1)

Configuring the pulse width trigger

Procedure

1. Press the Trigger menu key.



2. Press *Type* repeatedly to select pulse width trigger. The pulse width trigger indicator appears at the bottom of the display.

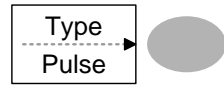

3. Press *Source* repeatedly to select the trigger source.

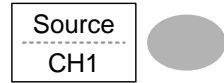

Range Channel 1, 2, Ext

4. Press *Mode* repeatedly to select the trigger mode, Auto or Normal. To select the Single trigger mode, press the Single key.

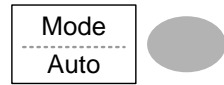

Range Auto, Normal

5. Press *When* repeatedly to select the pulse condition. Then use the Variable knob to set the pulse width.

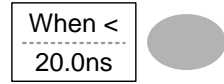

VARIABLE



Condition >, <, =, ≠

Width 20ns ~ 10s

6. Press *Slope/Coupling* to set trigger slope and coupling.



7. Press *Slope* repeatedly to select the trigger slope, which also appears at the bottom of the display.



Range Rising edge, falling edge

8. Press *Coupling* repeatedly to select the trigger coupling.

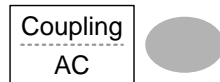

Range DC, AC

9. Press *Rejection* to select the frequency rejection mode.



Range LF, HF, Off

10. Press *Noise Rej* to turn the noise rejection on or off.

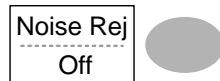

Range On, Off

11. Press *Previous* menu to go back to the previous menu.

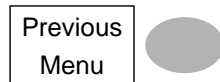

Manually triggering the signal



Note

Note: This section describes how to manually trigger the input signals when the oscilloscope does not capture them. This section applies to the Normal and Single trigger mode, since in the Auto trigger mode, the oscilloscope keeps updating the input signal regardless of the trigger conditions.

To acquire the signal regardless of trigger conditions

To acquire the input signal regardless of the trigger condition, press the Force key. The oscilloscope captures the signals once.



In the Single trigger mode

Press the Single key to start waiting for the trigger condition. To break out of the Single mode, press the Run/Stop key. The trigger mode changes to the Normal mode.



Rear Panel USB Port Interface

The Remote control interface section describes how to set up the USB interface for PC connection. The details of remote control commands are described in the DSO Programming Manual.

USB connection	PC end	Type A, host
	OSCILLOSCOPE end	Type B, slave
	Speed	1.1/2.0 (full speed)

Procedure

1. Connect the USB cable to the USB slave port on the OSCILLOSCOPE. 
2. When the PC asks for the USB driver, select `dso_cdc_1000.inf`
3. On the PC, activate a terminal application such as MTTY (Multi-Threaded TTY). To check the COM port No., see the Device Manager in the PC. For WindowsXP, select Control panel → System → Hardware tab.
4. Run this query command via the terminal application.
`*idn?`
 This command should return the manufacturer, model number, serial number, and firmware version in the following format.
 GW, DSO model, 000000001, V1.00

5. Configuring the command interface is completed. Refer to the programming manual for the remote commands and other details.

System Settings

The system settings show the oscilloscope's system information and allow changing the language.

Viewing the system information

Procedure

1. Press the Utility key.



2. Press *System Info*. The upper half of the display shows the following information.

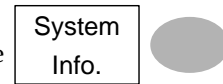

- Manufacturer
- Model
- Serial number
- Firmware version
- Web address

3. Press any other key to go back to the waveform display mode.



Selecting the language

Parameter

Language selection differs according to the region to which the oscilloscope is shipped.

- English
- Chinese (traditional)
- Chinese (simplified)
- Japanese
- Korean
- French

- German
 - Portuguese
 - Polish
 - Russian
 - Italian
 - Spanish
-

Procedure

1. Press the Utility key.



2. Press *Language* repeatedly to select the language.

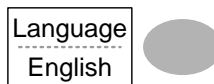

SAVE/RECALL

The save function allows saving display images, waveform data, and panel settings into the oscilloscope's internal memory or to the front panel USB port. The recall function allows recalling the default factory settings, waveform data, and panel settings from the oscilloscope's internal memory or from USB.

File Structures

Three types of file are available: display image, waveform file, and panel settings.

Display image file format

Format	xxxx.bmp (Windows bitmap format)
Contents	The current display image in 234 x 320 pixels, color mode. The background color can be inverted (Ink saver function).

Waveform file format

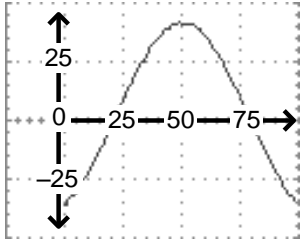
Format	xxxx.csv (Comma-separated values format which can be opened in spreadsheet applications such as Microsoft Excel)	
Waveform type	CH1, 2	Input channel signal
	Math	Math operation result (page 7575)
Storage location	Internal memory	The oscilloscope's internal memory, which can hold 15 waveforms.
	External USB Flash drive	A USB flash drive (FAT or FAT32 format) can hold practically an unlimited number of waveforms.
	Ref A, B	Two reference waveforms are used as a buffer to recall a waveform in the display. You have to save a waveform into internal memory or to USB, then copy the waveform into the reference waveform slot (A or B), and then recall the reference waveform into the display.
Waveform data format	One division includes 25 points of horizontal and vertical data. The vertical point starts from the center line. The horizontal point starts from the leftmost waveform.	
	The time or amplitude represented by each data point depends on the vertical and horizontal scale. For example: Vertical scale: 10mV/div (4mV per point) Horizontal scale: 100us/div (4us per point)	

Waveform file contents: other data	<p>A waveform file also includes the following information.</p> <ul style="list-style-type: none">• Memory length• source channel• vertical offset• vertical scale• coupling mode• waveform last dot address• date and time• trigger level• vertical position• time base• probe attenuation• horizontal view• horizontal scale• sampling period• sampling mode
------------------------------------	--

Setup file format

Format xxxx.set (proprietary format)
A setup file saves or recalls the following settings.

Contents	Acquire	<ul style="list-style-type: none"> mode
	Cursor	<ul style="list-style-type: none"> source channel cursor on/off cursor location
	Display	<ul style="list-style-type: none"> dots/vectors grid type accumulation on/off
	Measure	<ul style="list-style-type: none"> item
	Utility	<ul style="list-style-type: none"> hardcopy type language Data Logging settings ink saver on/off Go-Nogo settings
	Horizontal	<ul style="list-style-type: none"> display mode position scale
	Trigger	<ul style="list-style-type: none"> trigger type trigger mode video polarity pulse timing source channel video standard video line slope/coupling
	Channel (vertical)	<ul style="list-style-type: none"> vertical scale coupling mode bandwidth limit on/off vertical position invert on/off probe attenuation
	Math	<ul style="list-style-type: none"> operation type vertical position FFT window source channel unit/div

Using the USB file utilities

Background When a USB flash drive is inserted into the oscilloscope, file utilities (file deletion, folder creation and file/folder renaming) are available from the front panel.

Procedure

1. Insert a USB flash drive into the front panel USB port.

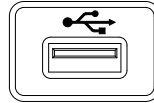

2. Press the Save/Recall key. Select any save or recall function. For example USB Destination in the Save image function.



(Example)

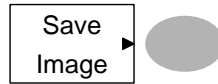

3. Press *File Utilities*. The display shows the USB flash drive contents.

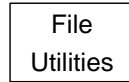

4. Use the Variable knob to move the cursor. Press Select to go into the folder or go back to the previous directory level.



USB flash drive indicator When a USB flash drive is inserted into the oscilloscope, an indicator appears at the right bottom corner of the display. (The USB flash drive shouldn't be removed when a file is saved or retrieved from USB).

USB

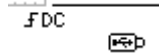

Creating a new folder / renaming a file or folder

1. Move the cursor to the file or folder location and press *New Folder* or *Rename*. The file/folder name and the character map will appear on the display.

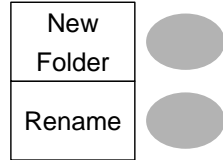

2. Use the Variable knob to move the pointer to the characters. Press *Enter Character* to add a character or *Back Space* to delete a character.

VARIABLE

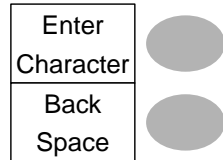

3. When editing is complete, press *Save*. The new/renamed file or folder will be saved.



Deleting a folder or file

1. Move the cursor to the folder or file location and press *Delete*. The message "*Press F4 again to confirm this process*" appears at the bottom of the display.
2. If the file/folder still needs to be deleted, press *Delete* again to complete the deletion. To cancel the deletion, press any other key.



Quick Save (HardCopy)

Background The Hardcopy key works as a shortcut to save display images, waveform data, and panel settings onto a USB flash drive card.



The Hardcopy key can be configured into two types of operations: save image and save all (image, waveform, setup).

Using the Save/Recall key can also save files with more options. For details, see page 130.



Functionalities	Save image (*.bmp)	Saves the current display image into a USB flash drive.
	Save all	Saves the following items into a USB flash drive. <ul style="list-style-type: none"> • Current display image (*.bmp) • Current system settings (*.set) • Current waveform data (*.csv)

Procedure 1. Insert a USB flash drive into the front panel USB port.

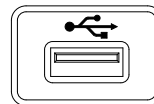

2. Press the Utility key.



3. Press *Hardcopy Menu*.

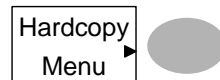

4. Press *Function* repeatedly to select *Save Image* or *Save All*.

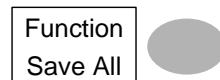

5. To invert the color in the display image, press *Ink Saver*. This turns Ink Saver on or off.



6. Press the Hardcopy key. The file or folder will be saved to the root directory of the USB flash drive.



Save

This section describes how to save data using the Save/Recall menu.

File type/source/destination

Item	Source	Destination
Panel setup (xxxx.set)	<ul style="list-style-type: none"> Panel settings 	<ul style="list-style-type: none"> Internal memory: S1 ~ S15 External memory: USB
Waveform data (xxxx.csv)	<ul style="list-style-type: none"> Channel 1, 2 Math operation result Reference waveform A, B 	<ul style="list-style-type: none"> Internal memory: W1 ~ W15 Reference waveform A, B External memory: USB
Display image (xxxx.bmp)	<ul style="list-style-type: none"> Display image 	<ul style="list-style-type: none"> External memory: USB
Save All	<ul style="list-style-type: none"> Display image (xxxx.bmp) Waveform data (xxxx.csv) Panel settings (xxxx.set) 	<ul style="list-style-type: none"> External memory: USB

Saving the panel settings

Procedure

1. (For saving to USB flash drive) Insert the USB flash drive into the front panel USB port.

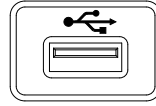

2. Press the Save/Recall key twice to access the Save menu.



3. Press *Save Setup*.



4. Press *Destination* repeatedly to select the saved location. Use the Variable knob to change the internal memory location (S1 ~ S15).

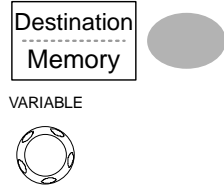

Memory Internal memory, S1 ~ S15



USB USB, no practical limitation for the amount of files. When saved, the setup file will be placed in the root directory.

5. Press *Save* to confirm saving. When completed, a message appears at the bottom of the display.





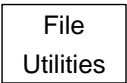

Note 

The file will not be saved if the power is turned off or the USB flash drive is removed before completion.

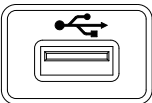
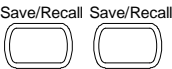
File utilities	To edit the USB drive contents (create/ delete/ rename files and folders), press <i>File Utilities</i> . For details, see page 126.		
----------------	---	---	---

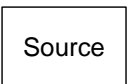
Saving the waveform

Procedure	1. (For saving to USB flash drive) Insert the USB flash drive into the front panel USB port.	
	2. Press the Save/Recall key twice to access the Save menu.	
	3. Press <i>Save Waveform</i> .	
	4. Press <i>Source</i> . Use the Variable knob to select the source signal.	 
	CH1 ~ CH2 Channel 1 ~ 2 signal	
	Math Math operation result (page 75)	
	RefA, B Internally stored reference waveforms A, B	

5. Press *Destination* repeatedly to select the file destination. Use the Variable knob to select the memory location.

Destination
Memory

VARIABLE



Memory	Internal memory, W1 ~ W15
USB	Save to the USB flash drive with a 4k waveform memory length.
Ref	Internal reference waveform, A/B

6. Press *Save* to confirm saving. When completed, a message appears at the bottom of the display.

Save

Note 

The file will not be saved if the power is turned off or the USB flash drive is removed from the USB port.

File utilities To edit the USB drive contents (create/ delete/ rename files and folders), press *File Utilities*. For details, see page 126.

File
Utilities

Saving the display image

Background Saving the display image can be used as a screen capture or it can be used as a reference waveform.

- Procedure**
1. Insert the USB flash drive into the front panel USB port. (Image files can only be saved to USB)

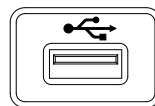

2. Press the *Save/Recall* key twice to access the *Save* menu.



3. Press *Save Image*.

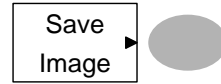

4. Press *Ink Saver* repeatedly to invert the background color (on) or not (off).

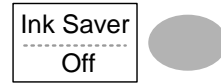

Note: *Destination* is set as USB. This cannot be changed.



5. Press *Save* to confirm saving. When completed, a message appears at the bottom of the display.

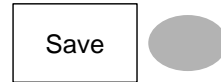

Note  The file will not be saved if the power is turned off or the USB flash drive is removed before completion.

File utilities

To edit the USB drive contents (create/ delete/ rename files and folders), press *File Utilities*. For details, see page 126.



Saving all (panel settings, display image, waveform)

Procedure

1. (For saving to USB flash drive) Insert the USB flash drive into the front panel USB port.



2. Press the Save/Recall key twice to access the Save menu.



3. Press *Save All*. The following information will be saved.

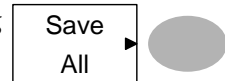

Setup file (Axxxx.set) Two types of setups are saved: the current panel setting and the last internally saved settings (one of S1 ~ S15).

Display image (Axxxx.bmp) The current display image in bitmap format.

Waveform data (Axxxx.csv) Two types of waveform data are saved: the currently active channel data and the last internally saved data (one of W1 ~ W15).

4. Press Ink Saver repeatedly to invert the background color (on) or not (off) for the display image.



5. Press *Destination*.



USB Save to the USB flash drive with a 4k waveform memory length.

6. Press *Save* to confirm saving. When completed, a message appears at the bottom of the display.



Note 

The file will not be saved if the power is turned off or the USB flash drive is removed from the USB port.

It takes approximately 1 min to save a 2M waveform to the USB drive in fast mode. Detailed mode may take over 10 times longer depending on the speed of the USB flash drive.

7. Together with the current setup/waveform/image, the last saved waveform file (one from W1 ~ W15) and setup file (one from S1 ~ S15) are also included in the folder.

File utilities

To edit the USB drive contents (create/ delete/ rename files and folders), press *File Utilities*. For details, see page 126.





Recall

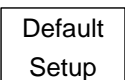

File type/source/destination

Item	Source	Destination
Default panel setup	<ul style="list-style-type: none"> Factory installed setting 	<ul style="list-style-type: none"> Current front panel
Reference waveform	<ul style="list-style-type: none"> Internal memory: A, B 	<ul style="list-style-type: none"> Current front panel
Panel setup (DSxxxx.set)	<ul style="list-style-type: none"> Internal memory: S1 ~ S15 External memory: USB flash drive 	<ul style="list-style-type: none"> Current front panel
Waveform data (DSxxxx.csv)	<ul style="list-style-type: none"> Internal memory: W1 ~ W15 External memory: USB flash drive 	<ul style="list-style-type: none"> Reference waveform A, B

Recalling the default panel settings

Procedure	1. Press the Save/Recall key.	<small>Save/Recall</small> 
	2. Press Default Setup. The factory installed setting will be recalled.	 

Setting contents The following is the default panel setting contents.

Acquisition	Mode: Normal	
Channel	Coupling: DC	Invert: Off
		Probe attenuation: x1
Cursor	BW limit: Off	
	Source: CH1	Horizontal: None
	Vertical: None	
Display	Type: Vectors	Accumulate: Off
	Graticule: 	
Horizontal	Scale: 2.5us/Div	Mode: Main Timebase
Math	Type: + (Add)	Channel: CH1+CH2
	Position: 0.00 Div	Unit/Div: 2V
Measure	Item: Vpp, Vavg, Frequency, Duty cycle, Rise Time	
Trigger	Type: Edge	Source: Channel1
	Mode: Auto	Slope: 
	Coupling: DC	Rejection: Off
	Noise Rejection: Off	
Utility	SaveImage, InkSaver Off.	

Recalling a reference waveform to the display

Procedure The reference waveform must be stored in advance. See page 132 for details.

1. Press the Save/Recall key.



2. Press *Display Refs.* The reference waveform display menu appears.



3. Select the reference waveform, *Ref A* or *Ref B*, and press it. The waveform appears on the display and the period and amplitude of the waveform appears in the menu.

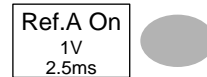
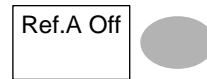

4. To clear the waveform from the display, press *RefA/B* again.

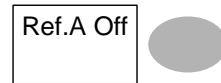

Recalling panel settings

- Procedure**
1. (For recalling to USB) Insert the USB flash drive into the front panel USB port.

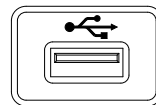

2. Press the Save/Recall key.



3. Press *Recall Setup*.



4. Press *Source* repeatedly to select the file source, internal or external memory. Use the Variable knob to change the memory.

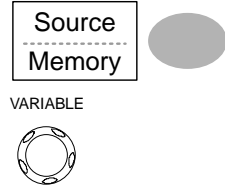

Memory Internal memory, S1 ~ S15

USB USB flash drive, DSXXXX.SET. The setup file(s) must be placed in the root directory to be recognized.

5. Press Recall to confirm recalling. When completed, a message appears at the bottom of the display.



Note  The file will not be recalled if the power is turned off or the USB flash drive is removed before completion.

File utilities

To edit the USB drive contents (create/ delete/ rename files and folders), press *File Utilities*. For details, see page 126.



Recalling a waveform

Procedure

1. (For recalling to USB) Insert the USB flash drive into the front panel USB port.

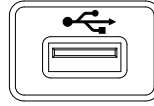

2. Press the Save/Recall key.



3. Press *Recall Waveform*. The display shows the available source and destination options.



4. Press *Source* repeatedly to select the file source, internal memory or USB. Use the Variable knob to change the memory location (W1 ~ W15)/DSXXXX.CSV.

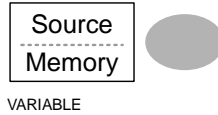

Memory	Internal memory, W1 ~ W15
USB	USB flash drive, DSXXXX.CSV. The waveform file(s) must be placed in the root directory to be loaded.

5. Press *Destination*. Use the Variable knob to select the memory location.



RefA, B	Internally stored reference waveforms A, B
---------	--

6. Press *Recall* to confirm recalling. When completed, a message appears at the bottom of the display.

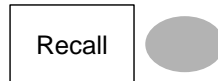

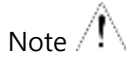

The file will not be recalled if the power is turned off or the USB flash drive is removed before completion.

File utilities

To edit the USB drive contents (create/ delete/ rename files and folders), press *File Utilities*. For details, see page 126.

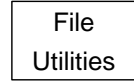

M MAINTENANCE

Two types of maintenance operations are available: calibrating the vertical resolution, and compensating the probe. Run these operations when using the oscilloscope in a new environment.

Vertical Resolution Calibration

Procedure

1. Press the Utility key.



2. Press the *More* key twice.



3. Press *Self Cal Menu*.

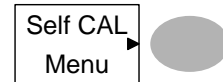

4. Press *Vertical*. The message "Set CAL to CH1, then press F5" appears at the bottom of the display.



5. Connect the calibration signal between the rear panel CAL out terminal and the Channel1 input.

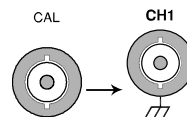

6. Press F5. The calibration automatically starts.

7. The Channel1 calibration will complete in less than 5 minutes.

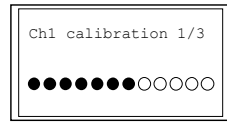

8. When finished, connect the calibration signal to the Channel 2 input and repeat the procedure.



9. When the calibration is complete the display will go back to the previous state.

Probe Compensation

Procedure

1. Connect the probe between the Channel1 input and the probe compensation output (2Vp-p, 1kHz square wave) on the front panel. Set the probe voltage attenuation to x10.

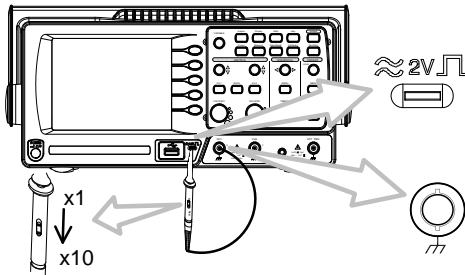



2. Press the Utility key.



3. Press *ProbeComp*.

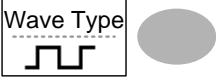

- 4. Press *Wavetype* repeatedly to select the standard square wave. 

- 5. Press the *Autoset* key. The compensation signal will appear in the display. 

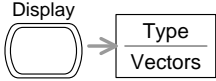
- 6. Press the *Display* key, then *Type* to select the vector waveform. 

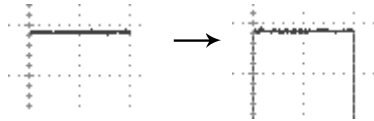

- 7. Turn the adjustment point on the probe until the signal edge becomes sharp.

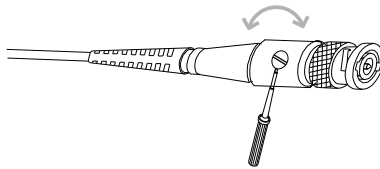
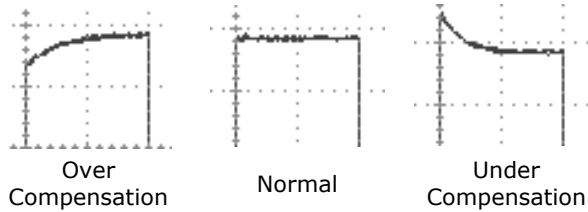

F AQ

-
- The input signal does not appear in the display.
 - I want to remove some contents from the display.
 - The waveform does not update (frozen).
 - The probe waveform is distorted.
 - Autoset does not catch the signal well.
 - Autoset function cannot catch signals under 30mV or 30Hz. Please use the manual operation. See page61 for details.
- I want to clean up the cluttered panel settings.
- The accuracy does not match the specifications.

The input signal does not appear in the display.

Make sure you have activated the channel by pressing the CH key (page 60).

I want to remove some contents from the display.

To clear the math result, press the Math key again (page75).

To clear the cursor, press the Cursor key again (page 72).

To clear the Help contents, press the Help key again (page 58).

The waveform does not update (frozen).

Press the Run/Stop key to unfreeze the waveform. See page 62 for details. For trigger setting details, see page 108.

If this does not help, press the CH key. If the signal still does not appear, press the Autoset key.

The probe waveform is distorted.

You might need to compensate the probe. For details, see page 145. Note that the frequency accuracy and duty factor are not specified for probe compensation waveforms and therefore it should not be used for other reference purposes.

Autoset does not catch the signal well.

Autoset function cannot catch signals under 30mV or 30Hz. Please use the manual operation. See page 61 for details.

I want to clean up the cluttered panel settings.

Recall the default settings by pressing the Save/Recall key→Default Setting. For default setting contents, see page 57.

The saved display image is too dark on the
background.

Use the Inksaver function which reverses the background color. For details, see page 133.

The accuracy does not match the specifications.

Make sure the device is powered on for at least 30 minutes, within +20°C~+30°C. This is necessary to stabilize the unit to match the specification.

For more information, contact your local dealer.

APPENDIX

Fuse Replacement

- Procedure
1. Remove the power cord and remove the fuse socket using a minus driver.

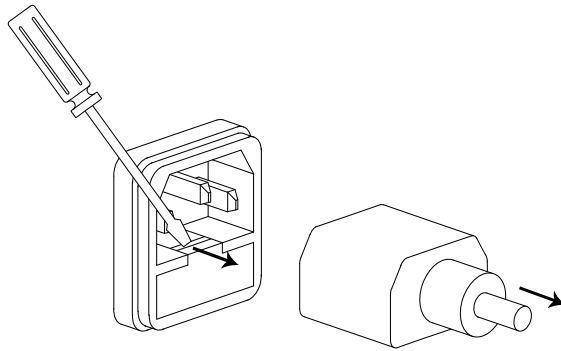

Replace the fuse in the holder.

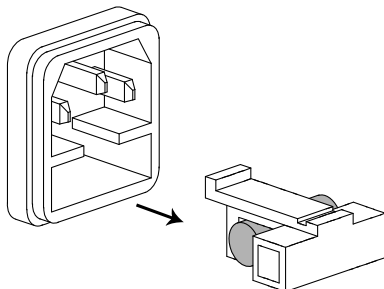

Ratings

T1A, 250V

Specifications

The specifications apply when the oscilloscope is powered on for at least 30 minutes under +20°C~+30°C.

Model-specific specifications

5352DC	Bandwidth (-3dB)	DC coupling: DC ~ 50MHz AC coupling: 10Hz ~ 50MHz
	Bandwidth Limit	20MHz (-3dB)
	Trigger	0.5div or 5mV (DC ~ 25MHz)
	Sensitivity	1.5div or 15mV (25MHz~50MHz)
	External Trigger	~ 50mV (DC~25MHz)
	Sensitivity	~ 100mV (25MHz~50MHz)
	Rise Time	< 14ns approx.
5372DC	Bandwidth (-3dB)	DC coupling: DC ~ 70MHz AC coupling: 10Hz ~ 70MHz
	Bandwidth Limit	20MHz (-3dB)
	Trigger	0.5div or 5mV (DC ~ 25MHz)
	Sensitivity	1.5div or 15mV (25MHz~70MHz)
	External Trigger	~ 50mV (DC~25MHz)
	Sensitivity	~ 100mV (25MHz~70MHz)
	Rise Time	< 5.8ns approx.
53102DC	Bandwidth (-3dB)	DC coupling: DC ~ 100MHz AC coupling: 10Hz ~ 100MHz
	Bandwidth Limit	20MHz (-3dB)
	Trigger	0.5div or 5mV (DC ~ 25MHz)
	Sensitivity	1.5div or 15mV (25MHz~100MHz)
	External Trigger	~ 50mV (DC~25MHz)
	Sensitivity	~ 100mV (25MHz~100MHz)

Rise Time	< 3.5ns approx.
-----------	-----------------

Common specifications

Vertical	Sensitivity	2mV/div~10V/Div (1-2-5 increments)
	Accuracy	$\pm (3\% \times \text{Readout} + 0.1\text{div} + 1\text{mV})$
	Bandwidth	See model-specific specifications
	Rise Time	See model-specific specifications
	Input Coupling	AC, DC, Ground
	Input	$1\text{M}\Omega \pm 2\%$, $\sim 15\text{pF}$
	Impedance	
	Polarity	Normal, Invert
	Maximum Input	300V (DC+AC peak), CAT II
	Math Operation	+, -, FFT
	Offset Range	2mV/div~50mV/div:
100mV/div~500mV/div:		$\pm 4\text{V}$
1V/div~5V/div:		$\pm 40\text{V}$
10V/div :		$\pm 300\text{V}$
Trigger	Sources	CH1, CH2, Line, EXT
	Modes	Auto, Normal, Single, TV, Edge, Pulse
	Coupling	AC, DC, LF rej, HF rej, Noise rej
	Sensitivity	See model-specific specifications
External trigger	Range	DC: $\pm 15\text{V}$, AC: $\pm 2\text{V}$
	Sensitivity	See model-specific specifications
	Input	$1\text{M}\Omega \pm 2\%$, $\sim 15\text{pF}$
	Impedance	
Maximum Input	300V (DC+AC peak), CATII	
Horizontal	Range	1ns/div~50s/div, 1-2.5-5 increment Roll: 50ms/div – 50s/div
	Modes	Main, Window, Window Zoom, Roll, X-Y

	Accuracy	±0.01%
	Pre-Trigger	10 div maximum
	Post-Trigger	1000 div
X-Y Mode	X-Axis Input	Channel 1
	Y-Axis Input	Channel 2
	Phase Shift	±3° at 100kHz
Signal Acquisition	Real-Time	250M Sa/s maximum
	Equivalent	25G Sa/s maximum
	Vertical Resolution	8 bits
	Record Length	4k points maximum
	Acquisition	Normal, Peak Detect, Average
	Peak Detection	10ns (500ns/div ~ 50s/div)
	Average	2, 4, 8, 16, 32, 64, 128, 256

Cursors and Measurement	Voltage	Vpp, Vamp, Vavg, Vrms, Vhi, Vlo, Vmax, Vmin, Rise Preshoot/ Overshoot, Fall Preshoot/ Overshoot
	Time	Freq, Period, Rise Time, Fall Time, + Width, – Width, Duty Cycle
	Cursors	Voltage difference (ΔV) and Time difference (ΔT) between cursors
	Auto Counter	Resolution: 6 digits, Accuracy: $\pm 2\%$ Signal source: All available trigger source except the Video trigger
Control Panel Function	Autoset	Automatically adjust Vertical Volt/div, Horizontal Time/div, and Trigger level
	Save/Recall	Up to 15 sets of measurement conditions and waveforms
Display	LCD	5.7 inch, TFT, brightness adjustable
	Resolution (dots)	234 (Vertical) x 320 (Horizontal)
	Graticule	8 x 10 divisions
	Display Contrast	Adjustable
Interface	USB Slave Connector	USB1.1 & 2.0 full speed compatible (flash disk not supported)
	USB Host connector	Image (BMP) and waveform data (CSV)
Probe Compensation Signal	Frequency range	1kHz ~ 100kHz adjustable, 1kHz step
	Duty cycle	5% ~ 95% adjustable, 5% step
	Amplitude	2Vpp $\pm 3\%$
Power Source	Line Voltage	100V~240V AC, 47Hz~63Hz
	Power Consumption	18W, 40VA maximum

	Fuse Rating	1A slow, 250V
Operation	Ambient temperature 0 ~ 50°C	
Environment	Relative humidity ≤ 80% @35°C	
Storage	Ambient temperature -20 ~ 70°C	
Environment	Relative humidity ≤ 80% @70°C	
Dimensions	310(W) x 142(H) x 140(D) mm	
Weight	Approx. 2.5kg	

Probe Specifications

Probe for 5352DC and 5372DC

Applicable model & probe	5352DC & 5372DC GTP-070A-4	
Position x 10	Attenuation Ratio	10:1
	Bandwidth	DC ~ 70MHz
	Input Resistance	10M Ω when used with 1M Ω input
	Input Capacitance	28~32pF approx.
	Maximum Input Voltage	\leq 600Vpk, Derating with frequency
	Position x 1	Attenuation Ratio
Bandwidth		DC ~ 6MHz
Input Resistance		1M Ω when used with 1M Ω input
Input Capacitance		120~220pF approx.
Maximum Input Voltage		\leq 200Vpk, Derating with frequency
Operating Cond.		Temperature
	Relative Humidity	\leq 85% @35°C
	Safety Standard	EN 61010-031 CAT II

Probe for 53102DC

Applicable model	53102DC	
& probe	GTP-100A-4	
Position x 10	Attenuation Ratio	10:1
	Bandwidth	DC ~ 100MHz
	Input Resistance	10MΩ when used with 1MΩ input
	Input Capacitance	14.5~17.5pF approx.
	Maximum Input Voltage	≤600Vpk, Derating with frequency
	Position x 1	Attenuation Ratio
Bandwidth		DC ~ 6MHz
Input Resistance		1MΩ when used with 1MΩ input
Input Capacitance		85~115pF approx.
Maximum Input Voltage		≤200Vpk, Derating with frequency
Operating Cond.		Temperature
	Relative Humidity	≤85% @35°C
	Safety Standard	EN 61010-031 CAT II

Dimensions

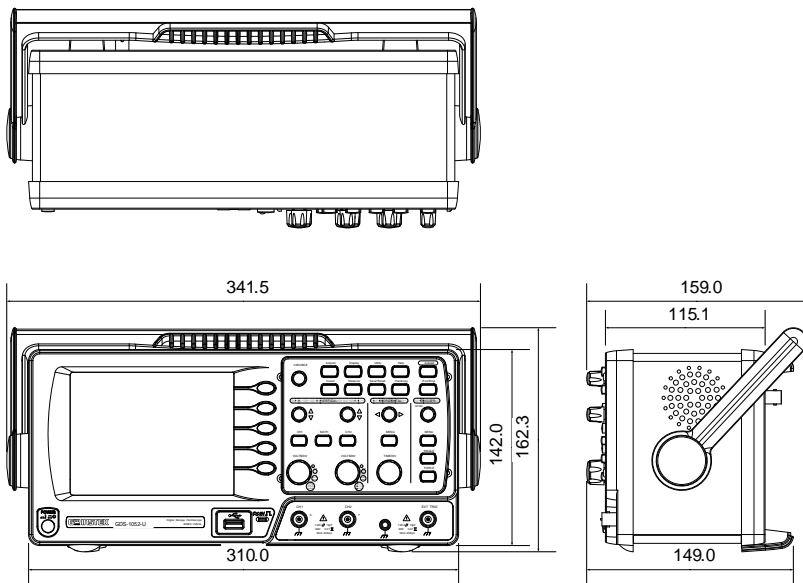

SEFRAM

32, rue Edouard MARTEL

F42009 – SAINT-ETIENNE Cedex 2

Phone: + 33 4 77 59 01 01

Fax: +33 4 77 57 23 23

Web: www.sefram.fr

E-mail: sales@sefram.fr