

PRIMETEST 250

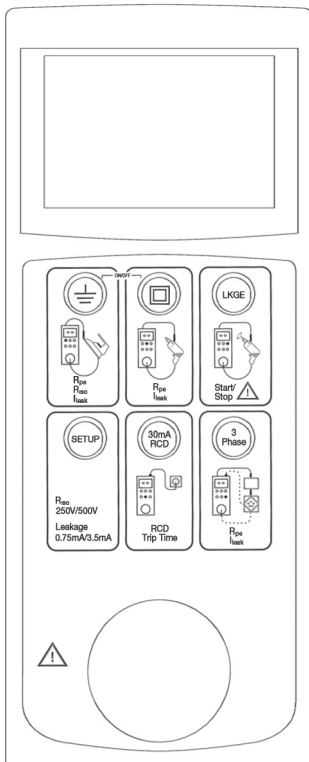

Operating Instructions

PRIMETEST **250**

Operating Instructions



Bracken Hill
South West Industrial Estate
Peterlee
Co Durham
SR8 2SW
ENGLAND
Tel: +44(0)191 5863511
www.seaward.co.uk
sales@seaward.co.uk
service@seaward.co.uk

Part Number 382A550 Revision 3
© 2013 Seaward Electronic Ltd

Limited Warranty & Limitation of Liability

SEAWARD Electronic Limited guarantees this product to be free from defects in material and workmanship under normal use and service for a period of 1 year. The period of warranty will be effective at the day of delivery.

(c) Copyright 2013

All rights reserved. Nothing from this edition may be multiplied, or made public in any form or manner, either electronically, mechanically, by photocopying, recording, or in any manner, without prior written consent from SEAWARD Electronic Limited. This also applies to accompanying drawings and diagrams.

Due to a policy of continuous development SEAWARD Electronic Limited reserves the right to alter the equipment specification and description outlined in this publication without prior notice and no part of this publication shall be deemed to be part of any contract for the equipment unless specifically referred to as an inclusion within such contract.

Disposal of old product

This product has been designed and manufactured with high quality materials and components that can be recycled and reused.

When this symbol is attached to a product it means the product is covered by the European Directive 2012/19/EU.

Please familiarise yourself with the appropriate local separate collection system for electrical and electronic products.

Please dispose of this product according to local regulations. Do not dispose of this product along with normal waste material. The correct disposal of this product will help prevent potential negative consequences for the environment and human health.

DECLARATION OF CONFORMITY

As the manufacturer of the apparatus listed, declare under our sole responsibility that the product:

SEAWARD PrimeTest 250

To which this declaration relates are in conformity with the relevant clauses of the following standard:

BS EN 61010-1:2010

Safety requirements for electrical equipment for measurement, control, and laboratory use – Part 1: General requirements.

BS EN 61010-2-30:2010

Safety requirements for electrical equipment for measurement, control, and laboratory use – Part 2-030: Particular requirements for testing and measuring circuits.

BS EN 61326:2006

Electrical equipment for measurement, control and laboratory user-EMC Requirements

Performance: The instrument operates within specification when used under the conditions in the above standards EMC and Safety Standards.

The product identified above conforms to the requirements of Council Directive 2004/108/EC and 2006/95/EC.

This Conformity is indicated by the symbol **CE**, i.e. “Conformité Européenne”

Seaward Electronic Ltd is registered under BS EN ISO9001:2000 Certificate No: Q05356.

Contents

1	Important Information	6
2	Introduction	13
3	Performing Tests	15
3.1	Checking a mains power outlet	15
3.2	Testing a Class I Appliance	16
3.3	Testing a Class II Appliance.....	21
3.4	Testing a mains cord	23
3.5	Testing an extension lead	25
3.6	Changing the Insulation Test Voltage ...	25
3.7	Changing the CLI Leakage limit.....	25
3.8	Performing an RCD test.....	25
3.9	Performing a 3-Phase Sequence.....	27
4	Specification.....	29
5	Maintenance.....	31
6	Battery Check.....	31
6.1	Battery Replacement	32
7	Service and Calibration	33

1 Important Information

These operating instructions are intended for the use of adequately trained personnel.

The following symbols are used in these operating instructions and on the PrimeTest 250.



Caution, risk of electric shock.
Indicates instructions must be followed to avoid danger to persons.



Caution, risk of danger. The operating instructions must be adhered to in order to avoid danger.

Before use, ensure unit is clean and dry; visually inspect all leads, connectors, and case. Any damage or wear must be rectified prior to use.

Standard Accessories

	Part Number
Seaward PrimeTest 250 unit	382A910
Carry Case	71G082
Black Test Lead 1m	44B154
IEC mains cord 0.5m	300A002
Operating Instructions	382A550
Mains Lead	44B141

Optional Accessories

	Part Number
TPA 5/16 3 Phase Adaptor	
TPA 5/32 3 Phase Adaptor	
TPA 4/16 3 Phase Adaptor	
TPA 4/32 3 Phase Adaptor	
NiMH Batteries and charger	339A950

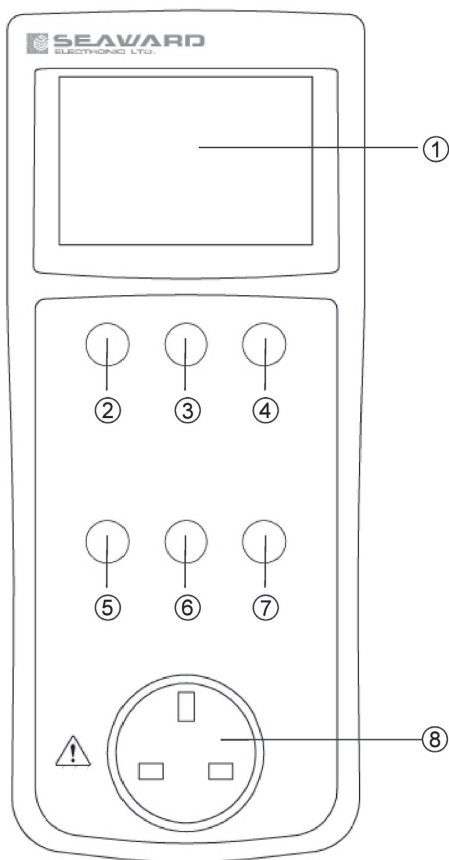

Figure 1. PrimeTest 250 Front View

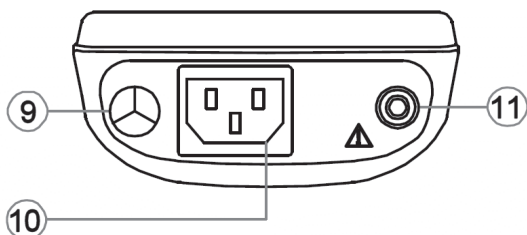

Figure 2. PrimeTest 250 End View

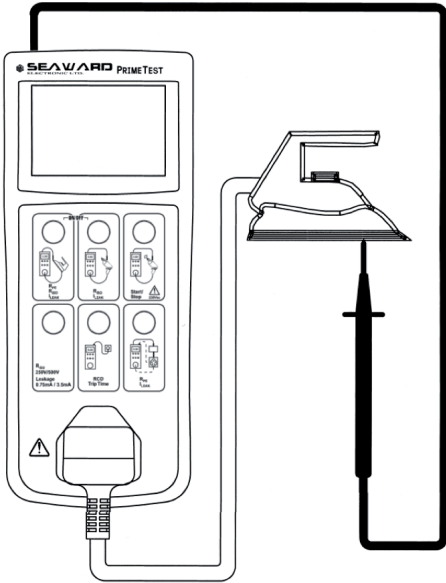

Figure 3. Testing CLI appliances, no mains leakage

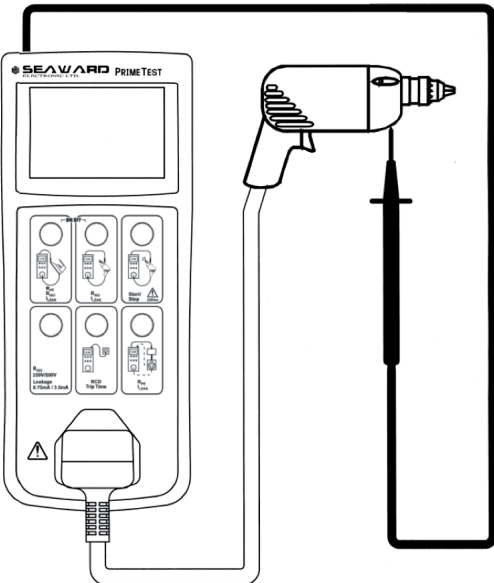

Figure 4. Testing CLII appliances, no mains leakage

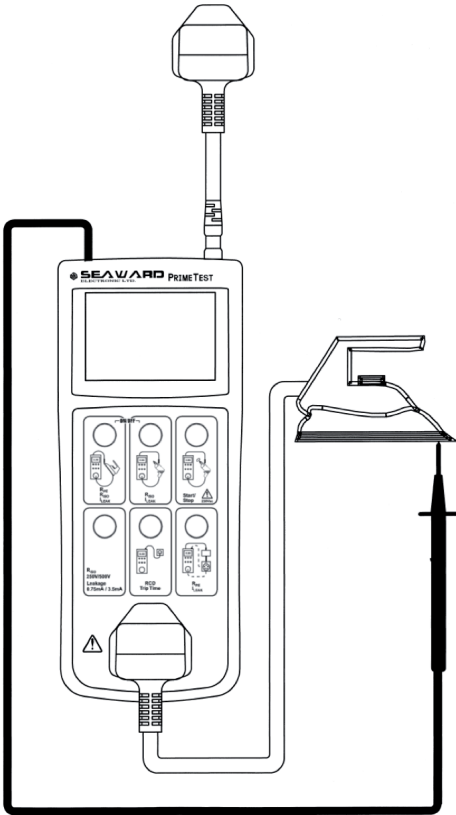

Figure 5. Testing CLI appliances, mains leakage

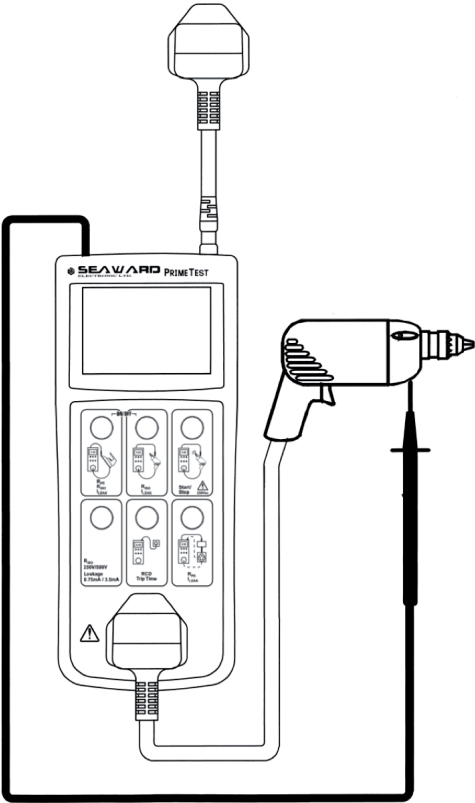

Figure 6. Testing CLII appliances, mains leakage

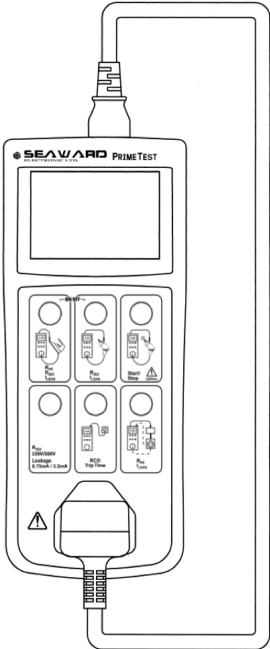

Figure 7. Testing IEC Leads

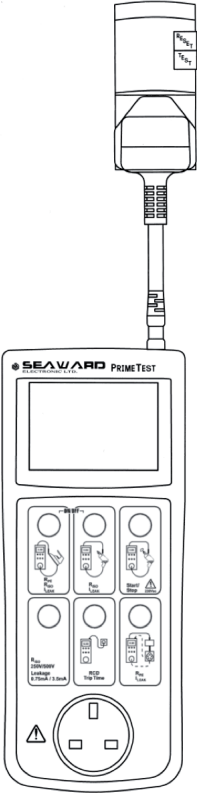

Figure 8. Testing plug top RCD

2 Introduction

The PrimeTest 250 is a hand held battery powered unit suitable for carrying out electrical safety checks on:

- Class I appliances
- Class II appliances
- IEC mains leads
- Extension leads
- 30mA RCD
- Mains outlet wiring
- 3-Phase appliances when used with the Seaward TPA range of 3-phase adaptors.

Overview

With reference to Figures 1 and 2.

1. The LCD display
2. CLI / Cord Sequence Key
3. CLII Test Sequence Key
4. Leakage Test Start Key
5. Setup Button
6. 30mA RCD Test Key
7. 3-Phase Test Sequence Key
8. Test/Mains outlet socket
9. Mains inlet socket
10. IEC Test Connection
11. Earth Continuity Test Terminal

User Interface

The LCD display shows test progress, results for individual tests and the overall test result for an appliance or mains cord.

Power ON/OFF = press and hold CLI and CLII simultaneously

Class I appliance test = press the CLI key

Class II appliance test = press the CLI key

Cord / extension lead test = press the CLI key

Enter Setup Mode = press the SETUP key

Once in the setup mode the CLII button can be used to change the Insulation voltage while the LKGE button can be used to change the ILEAK pass/fail limit. To leave the setup mode press the SETUP button.

30mA RCD test = press the 30mA RCD key

3 phase appliance test = press the 3 phase key

Note: The PrimeTest 250 will automatically switch OFF after approximately 1 minute if no keys are pressed.

Note: When a key is pressed to initiate a test sequence, the PrimeTest 250 will compare the type of appliance connected with the test sequence that has been selected, and where possible, will prompt the user if an inappropriate test has been selected.

For example, if an IEC lead is connected between the front panel mains socket and the IEC socket on the end panel and a CLI appliance test is selected, the PrimeTest 250 will flash the Cord test enunciator to indicate that the Cord test is the most appropriate test.

3 Performing Tests

Press CLI and CLII keys simultaneously to switch on the PrimeTest 250. When the unit is ready the display will be as shown below.

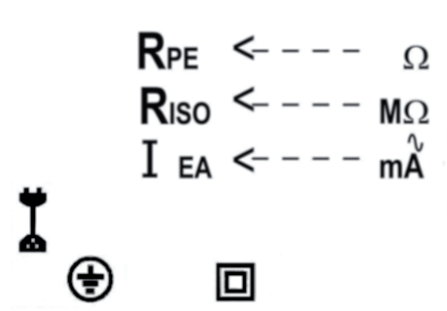

3.1 Checking a mains power outlet

Connect PrimeTest 250 mains lead to the mains inlet socket and to the power outlet to be tested.

Each time mains voltage is detected, the line-neutral, line-earth and neutral-earth voltages will be displayed for 2s as shown below.

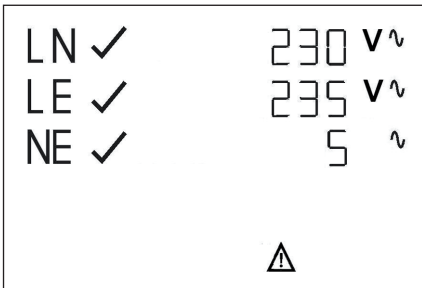

If the voltages are within the acceptable limits shown below, a tick is shown next to the enunciator.

LN	195V-253V
LE	195V-253V
NE	<30V

After 2s the display will return to the start up screen.

If the mains voltage is incorrect then the PrimeTest 250 will remain in voltage mode until the voltage is corrected or removed.

3.2 Testing a Class I Appliance

- Visually inspect the appliance and mains cord for signs of damage.
- If the appliance passes a visual inspection proceed with the electrical tests.
- Plug the earth test lead into the Earth Continuity Test Terminal on the PrimeTest 250 end panel.
- Plug the appliance into the PrimeTest 250 front panel test/mains outlet socket.
- Connect the earth test probe to an exposed metal part on the appliance.
- If the appliance under test has an ON/OFF switch, make sure it is in the ON position.
- Press the CLI test key
- The PrimeTest 250 will now will perform a measurement of the protective earth continuity, reverse the test current and repeat the measurement. The highest measured value that occurred during the two tests is displayed.
- If the measured value is higher than the factory set pass/fail threshold, the measured value is displayed and the unit indicates a fail result as shown below and the test sequence is halted.

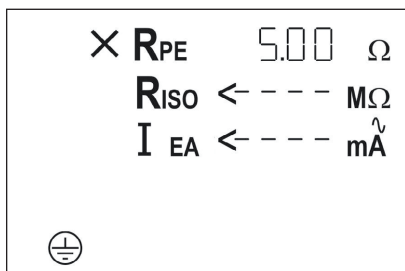

- If the measured value is less than the factory set pass/fail threshold, the measured value is displayed and the unit indicates a pass result, as shown below.

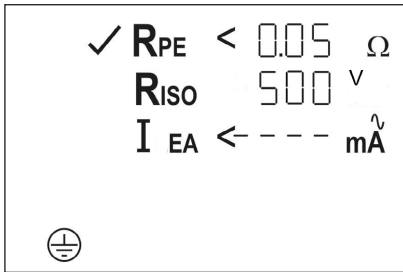

Note: The PrimeTest 250 can perform a continuous Rpe measurement (max 3 minutes). Press and hold the CLI key for approximately 5s until the unit emits a beep and the symbol appears on the display. The PrimeTest 250 continuously displays the current measured value on the display and stores the maximum value in the memory. By pressing the CLI key 2 again, the measurement is repeated with reversed polarity. Press the key again to terminate the Rpe test and display the maximum value of RPE on the display.

- The insulation test voltage is shown momentarily next to the Riso enunciator.
- The unit will proceed with the Insulation and Leakage tests.

Note: *The power switch on the appliance under must be in the ON position to perform an insulation test. If no appliance is detected the PrimeTest 250 will display the following.*

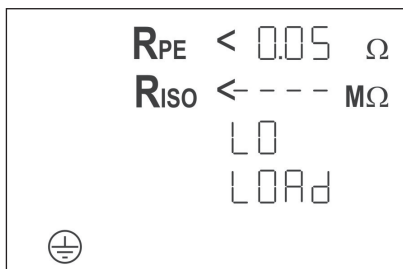

- Check that the appliance power switch is in the ON position. The test will automatically proceed if the appliance power switch is placed in the ON position.
- If the **LO LOAD** enunciator remains on the display, the load presented by the appliance may be too small for the PrimeTest 250 to detect. In this case, press the CLI test key to continue.
- If the Insulation Resistance is greater than the factory set limit a tick is placed next to the **Riso** enunciator. If the Insulation Resistance is less than the set limit a cross is placed next to the **Riso** enunciator, the **FAIL** enunciator is displayed and the test sequence is halted.

Note: If a mains supply is detected, the PrimeTest 250 will perform a differential leakage test. If the PrimeTest 250 does not detect a mains supply then the PrimeTest 250 will perform a substitute leakage test.

- If a substitute leakage test is performed then the PrimeTest 250 will start the test without the need for user intervention. If the substitute leakage is less than the factory set limit a tick is placed next to the **lea** enunciator.

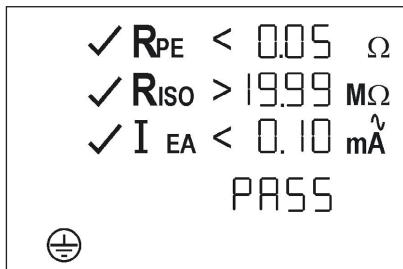

- If a differential leakage test is performed then the test PrimeTest 250 will prompt the user to start the Leakage test by flashing the **leak** icon. If no key is pressed the PrimeTest 250 will timeout and return to the start screen.

**Note: If the LKGE key is pressed momentarily the differential test duration is 5s.
If the LKGE key is pressed and held for 2s the differential test duration is 30s.**

When the duration is set to 30s, the test can be terminated at any time by pressing the LKGE key.

- When the LKGE key is pressed to start the differential leakage test the PrimeTest 250 will check the incoming mains supply to ensure that the voltages are correct. The enunciators are displayed if there is an error with the connected mains supply:

LN	LE	NE	Mains status
Flash	Flash	OFF	No mains
OFF	Flash	Flash	Earth fault or Live and Neutral reverse

- If the mains voltage is correct, the PrimeTest 250 will proceed with the differential leakage test.

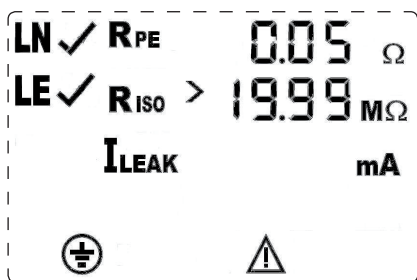

- If the Differential Leakage is less than the factory set limit a tick is placed next to the **leak** enunciator.
- If all of the tests within the sequence have passed then the **PASS** enunciator is illuminated.

3.3 Testing a Class II Appliance

- Visually inspect the appliance and mains cord for signs of damage.
- If the appliance passes a visual inspection proceed with the electrical tests.
- Plug the earth test lead into the Earth Continuity Test Terminal on the PrimeTest 250 end panel.
- Plug the appliance into the PrimeTest 250 front panel test/mains outlet socket.
- Connect the earth test probe to an exposed metal part on the appliance.
- If the Appliance under test has an ON/OFF switch, make sure it is in the ON position.
- Press the CLII test key
- The display will momentarily show the insulation test voltage before proceeding with the test.

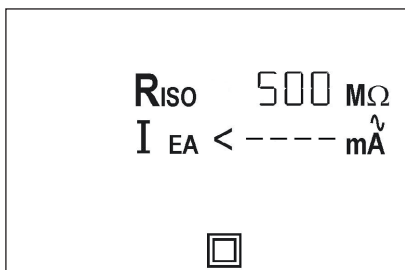

Note: *The power switch on the appliance under must be in the ON position to perform an insulation test. If no appliance is detected the PrimeTest 250 will display the following.*

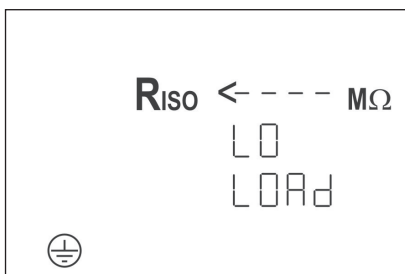

- Check that the appliance power switch is in the ON position. The test will automatically proceed if the appliance power switch is placed in the ON position.
- If the **LO LOAD** enunciator remains on the display, the load presented by the appliance may be too small for the PrimeTest 250 to detect. In this case, press the CLII test key to continue.
- The PrimeTest 250 will perform an Insulation test. If the Insulation Resistance is greater than the factory set limit a tick is placed next to the **Riso** enunciator. If the Insulation Resistance is less than the set limit a cross is placed next to the **Riso** enunciator, the **FAIL** enunciator is displayed and the test sequence is halted.

Note: If a mains supply is detected, the PrimeTest 250 will perform a touch leakage test. If the PrimeTest 250 does not detect a mains supply then the PrimeTest 250 will perform a substitute leakage test.

- If a Substitute Leakage test is performed then the PrimeTest 250 will start the test without the need for user intervention. If the Substitute Leakage is less than the factory set limit a tick is placed next to the **lea** enunciator.

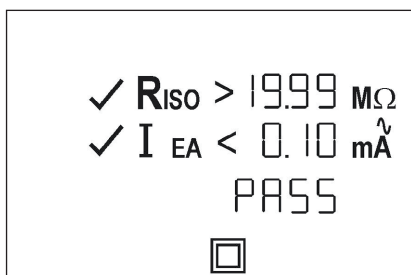

- If a touch leakage test is performed then the test PrimeTest 250 will prompt the user to start the Leakage test by flashing the **leak** icon. If no key

is pressed the PrimeTest 250 will timeout and return to the start screen.

**Note: If the LKGE key is pressed momentarily the touch leakage test duration is 5s
If the LKGE key is pressed and held for 2s the touch leakage test duration is 30s.**

When the duration is set to 30s, the test can be terminated at any time by pressing the LKGE key.

- When the LKGE key is pressed to start the touch leakage test the PrimeTest 250 will check the incoming mains supply to ensure that the voltages are correct. The enunciators are displayed if there is an error with the connected mains supply:

LN	LE	NE	Mains status
Flash	Flash	OFF	No mains
OFF	Flash	Flash	Earth fault or Live and Neutral reverse

- If the mains voltage is correct, the **PrimeTest 250** will proceed with the touch leakage test.
- If the touch leakage is less than the factory set limit a tick is placed next to the **leak** enunciator.
- If all of the tests within the sequence have passed then the **PASS** enunciator is illuminated.

3.4 Testing a mains cord

- Visually inspect the mains cord and plug for signs of damage.
- Check that the correct fuse is fitted.
- If the cord passes a visual inspection proceed with the electrical tests.
- Plug the mains cord under test into the IEC socket and the front panel test/mains socket on the PrimeTest 250.
- Press the CLI test key

- The PrimeTest 250 will first test the continuity of the protective earth.
- If the measured value is greater than the factory set limit a cross is placed next to the **R_{PE}** enunciator, a FAIL is indicated and the test sequence will be halted.
- If the measured value is less than the factory set limit a tick is placed next the **R_{PE}** enunciator.
- The unit will proceed with the Insulation test.
- If the Insulation Resistance is lower than the factory set limit a cross is placed next to the **R_{ISO}** enunciator and the test sequence is halted.
- If the Insulation Resistance is greater than the factory set limit a tick is placed next to the **R_{ISO}** enunciator. If the Insulation Resistance is less than the set limit a cross is placed next to the **R_{ISO}** enunciator, the **FAIL** enunciator is displayed and the test sequence is halted.
- The unit will proceed with the wiring test, checking the live and neutral conductors for short or open circuit and reverse connections
- If the wiring is correct a tick is placed next to the cord enunciator, the **GOOD** enunciator is illuminated and a **PASS** is indicated for the sequence.

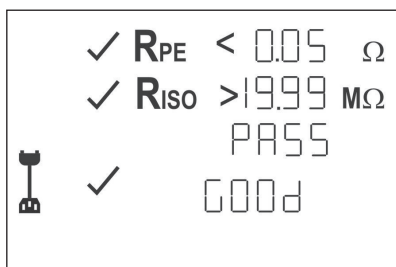

Note: If the tested cord has a wiring fault, one of the following enunciators will be illuminated in place of **GOOD**

- **OPEN** indicates that either the live or neutral conductor is broken (open circuit)

- **Shor indicates that the live and neutral conductors are shorted together**
- **CrOS indicates that the live and neutral conductors are reversed**

3.5 Testing an extension lead

- Visually inspect the mains cord and plug for signs of damage.
- Check that the correct fuse is fitted.
- If the cord passes a visual inspection proceed with the electrical tests.
- Plug the supplied 0.5m IEC lead into the IEC socket and into a mains outlet on the extension lead. Plug the mains plug of the extension lead into the front panel mains socket on the PrimeTest 250.
- The extension lead can now be tested in the same manner as an IEC as described above.

3.6 Changing the Insulation Test Voltage

The Insulation test performed in the CLI and CLII test sequences can be changed to 250V for appliances with MOVs which would fail an Insulation test performed at 500V.

In order to change the Insulation voltage press the SETUP button to enter setup mode. Once in setup mode press the CLII button, the selected insulation voltage will be displayed next to the Riso enunciator.

To Leave setup mode press the SETUP button.

3.7 Changing the CLI Leakage limit

The CLI Leakage pass/fail limit can be changed between 0.75mA and 3.5mA.

In order to change the Leakage limit press the SETUP button to enter setup mode. Once in setup mode press the LKGE button, the selected pass/fail limit will be displayed next to the **leak** enunciator.

To Leave setup mode press the SETUP button.

3.8 Performing an RCD test

The PrimeTest 250 can be used to measure the operating time of an RCD.



When plugging the mains lead into the PrimeTest 250 plus ensure that the polarity orientation of the connector is correct. DO NOT FORCE THE PLUG INTO THE CONNECTOR. Doing so may damage the PrimeTest 250.

The test configuration depends upon the type under test:

a) Portable RCD

Connect the portable RCD under test to a non RCD protected mains outlet. If the mains outlet is part of an RCD protected circuit, an isolation transformer will be required. Connect the PrimeTest 250 mains lead to the mains inlet socket of the PrimeTest 250 and mains outlet of the RCD.

b) Circuit RCD

Connect the PrimeTest 250 mains lead to the mains inlet socket of the PrimeTest 250 and a mains outlet on the RCD protected circuit.

To test the RCD operating time press the 30mA RCD test key.

The mains supply status is checked and the status is indicated using the LN, LE and NE enunciators of the LCD.

LN	LE	NE	Mains status
Flash	Flash	OFF	No mains
OFF	Flash	Flash	Earth fault

The operating time of the RCD will be shown on the PrimeTest 250 display.

The PrimeTest 250 will alternate between 0° and 180° in between tests. It is essential that two RCD tests are performed in order to cover both 0° and 180° conditions.

3.9 Performing a 3-Phase Sequence

The PrimeTest 250 can be used to measure Rpe and earth leakage current on 3 phase equipment when used with the optional 3 phase adaptor accessory.

- Visually inspect the appliance and mains cord for signs of damage.
- If the appliance passes a visual inspection proceed with the electrical tests.
- Refer to the documentation supplied with the 3 phase adaptor and connect the adaptor in line with the 3 phase equipment under test.
- Connect the 3 phase adaptor test lead to the mains input socket 9 on the PrimeTest 250.
- Connect the Rpe test probe to an exposed conductive part on the 3 phase equipment.
- Press the 3 phase key on the PrimeTest 250 to begin the test.
- If there is a contact voltage present on the conductive parts of the equipment under test, the test is terminated and a **Volt on test Probe** warning message is shown on the display.
- Otherwise, the PrimeTest 250 will proceed with the Rpe measurement, reverse the test current and then repeat the measurement. The highest measured value that occurred during the two tests is displayed for approximately 2s.

Note: There is no factory programmed test limit for the 3 phase Rpe measurement and so no tick or cross is displayed.

- The PrimeTest 250 will then display the current flowing in the protective conductor of the 3 phase supply.

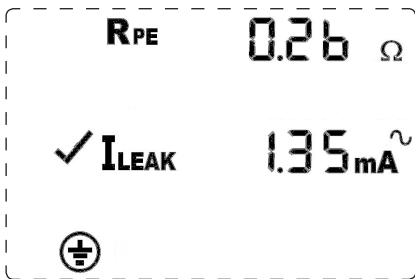

- The 3-Phase leakage test will run for 30 seconds but can be stopped earlier by pressing the 3-Phase button.

Note: If the 3-Phase key is pressed while no adaptor is connected to the PrimeTest 250 plus then a warning message **PLUG IN 3 PH ADPTR** will be displayed.

4 Specification

Earth Continuity

Display Range	0.01ohms to 19.99ohms
Measuring Range	0.05ohms to 19.99ohms
Accuracy	\pm (5% + 2 digits)
Test current	200mA minimum
Test voltage	6V nominal

Insulation resistance

Display Range	0.01Mohms to 19.99Mohms
Measuring Range	0.10Mohms to 19.99Mohms
Accuracy	\pm (5% + 2 digits)
Test voltage	250V / 500V
Test current	>1mA
Test current	<2mA into 2k

Substitute Leakage Current

Display Range	0.10mA to 19.99mA
Measuring Range	0.25mA to 19mA
Accuracy	\pm (5% + 2 digits)
Test voltage	40V rms, 50Hz AC
Test current	<10mA into 2k

Differential Leakage Current

Display Range	0.15mA to 19.99mA
Measuring Range	0.25mA to 19mA
Accuracy	\pm (5% + 2 digits)
Test voltage	mains voltage, 50Hz AC

Touch Leakage Current

Display Range	0.10mA to 3.5mA
Measuring Range	0.10mA to 1.99mA
Accuracy	\pm (5% + 2 digits)
Test voltage	mains voltage, 50Hz AC

3-Phase Leakage Current

Display Range	0.10mA to 9.99mA
Measuring Range	0.25mA to 9.99mA
Accuracy	\pm (5% + 2 digits)
Test voltage	mains voltage, 50Hz AC

Cord Test

Earth continuity, insulation resistance as above.
Check for Live and Neutral open circuit, short circuit or reversed polarity.

RCD Test

Display Range 0ms to 500ms
Measuring Range 10ms to 500ms
Accuracy $\pm 2\text{ms}$
Test Current 30mA
Current Accuracy -0, +10%

Factory Set Pass/Fail limits

	Earth Continuity	Insulation Resistance	Leakage
Class I	0.2 ohms	1.0Mohm	0.75 / 3.5
Class II	n/a	2.0Mohm	0.25mA
Cord	0.2 ohms	1.0Mohm	n/a
3-Phase	0.2 ohms	1.0Mohm	3.5mA

Environmental rating

IP Rating IP40

Operating temperature range 0°C to 40°C, without moisture condensation.

Storage temperature range -25° to 65°.

Note: Batteries should be removed prior to storage.

Overvoltage category 300V CAT II

5 Maintenance

Clean only with a dry cloth; do not use solvents. Before use, ensure unit is clean and dry; visually inspect all leads, connectors, and case. Any damage or wear must be rectified to preserve user safety.

Check the battery contacts and compartment are free of electrolytic contamination. Any contamination of the battery contacts or compartment should be cleaned with a dry cloth.

Note: The PrimeTest 250 contains no user serviceable parts. If an **Error** warning should appear on the display please contact the manufacturer or an **authorised Seaward Service Agent** for advise.

6 Battery Check

The PrimeTest 250 is powered from a 6 AA cells which are checked before a test is performed. When the battery voltage is low the  enunciator is illuminated. The unit will continue to perform within specification for a limited number of tests, dependent upon the type of the batteries fitted.

When the battery voltage reaches a level where the performance is affected the  enunciator will flash and all test keys are disabled. The batteries must be replaced.

6.1 Battery Replacement



Before opening the PrimeTest 250 ensure that all test leads are disconnected.

- Switch off the unit by pressing and holding the CLI and CLII keys.
- Disconnect all leads from the PrimeTest 250.
- Place the PrimeTest 250 face down and release the captive screw in the battery compartment cover.
- Remove the battery compartment cover and remove the discharged batteries.
- Insert the replacement batteries into the battery compartment ensuring that the battery polarity matches the marking on the inside of the battery compartment.
- Relocate the battery cover over the battery compartment and fasten in position with the battery cover captive screw.

7 Service and Calibration

To maintain the specified accuracy of the measurement results, the instrument must be recalibrated at regular intervals by either the manufacturer or an **authorised service agent**. We recommend a recalibration period of one year.

For help or advise on Service and Calibration contact:

