

EPPE CX | PX

Power Quality Analyser

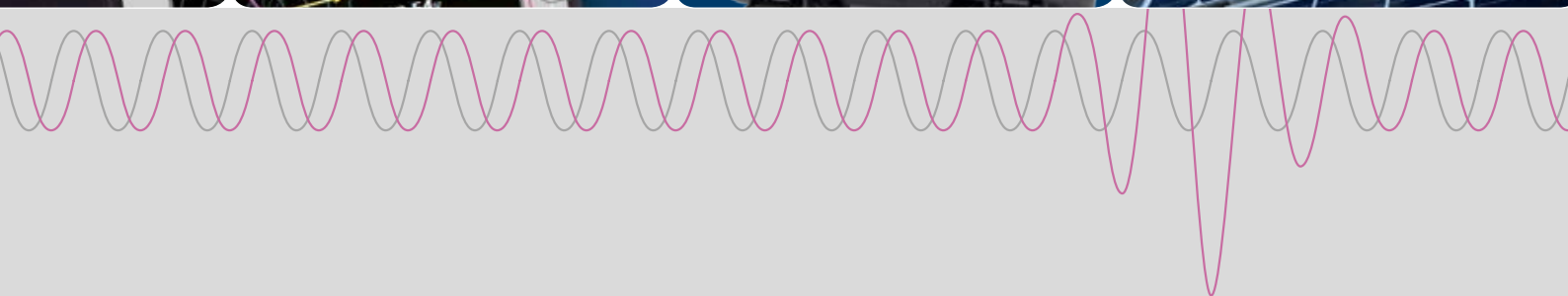



CONTENTS

EPPE CX | PX - POWER QUALITY ANALYSER

EPPE Power Quality Analyser.....	3
Inputs and outputs.....	6
Communication.....	10
Data memory.....	12
Power supply.....	13
Time synchronization.....	14
Recording functions.....	16
Operating concept.....	18
Software for operation and evaluation.....	20
Evaluation.....	24
Installation.....	28
Technical data EPPE CX.....	30
Technical data EPPE PX.....	32
Product overview EPPE CX.....	34
Product overview EPPE PX.....	36
Examples of applications.....	37

EPPE

POWER QUALITY ANALYSER

Power quality measuring systems with integrated fault recorder for professional power quality analysis

Whatever processes are currently underway in a power system, the power quality analysers of the EPPE series will register even minor disturbances or alterations. All the parameters of an electrical supply system are recorded continuously and precisely. Detailed quality evaluations reveal even the slightest of deviations and help identify the cause of disturbances.

Precise time synchronization of the measuring systems via GPS allows the measured data from a number of different devices to be consolidated in order to comprehensively monitor an entire supply system.

EPPE systems continuously capture all power system parameters for the analysis and documentation of power quality to standards defined by the individual user or international standards such as EN 50160 or IEC 61000. High storage capacities and effective data compression methods enable long-term recordings to be made over periods of up to several years.

As well as continuously recording all the quantities relevant to power quality, the integrated fault recorder module allows the event-triggered capture of transient processes with sampling rates of up to 30 kHz.



EPPE CX | PX

Multi-functional measurement technology for fully automatic power monitoring

EPPE CX and EPPE PX are powerful, multi-functional measuring instruments for comprehensive, continuous and fully automatic power monitoring at all voltage levels.

Various different types of signal inputs for voltages and currents as well as optional sensor inputs and outputs make the devices extremely flexible to use. EPPE CX | PX can be tailored to meet the individual needs and requirements of the user.

The applications listed below are given as examples of the wide range of different uses of the devices:

- Power quality analysis
- Power quality monitoring
- Differential current measurement
- Fault analysis
- Measurement of harmonics
- Monitoring and analysis of renewable power systems
- Network optimisation
- Load management
- Monitoring to EN 50160
- Fault location
- Trend recording
- Critical load monitoring
- Consumption measurements, e.g. for load optimisation

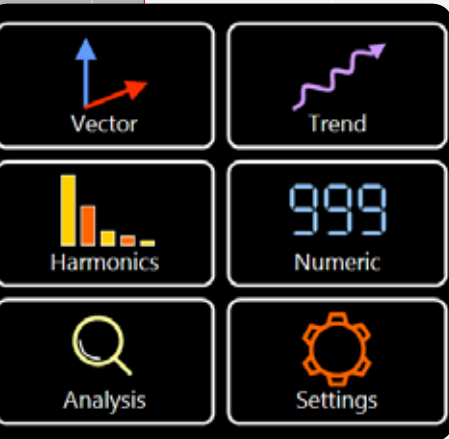



EPPE CX
Stationary, fully automatic monitoring system for panel mounting

EPPE CX is ideal for fully automatic monitoring with continuous measurement data transfer to a central data system. Evaluation is performed automatically and a built-in alarm system informs the employees responsible should a fault occur.



EPPE PX
The portable solution in a carrying case

EPPE PX has been specially developed for mobile measurements and installation monitoring. Sensor inputs, direct inputs for current measurement and galvanically isolated voltage inputs make the device extremely flexible to use. The rugged carrying case protects the measuring device even in harsh environmental conditions.

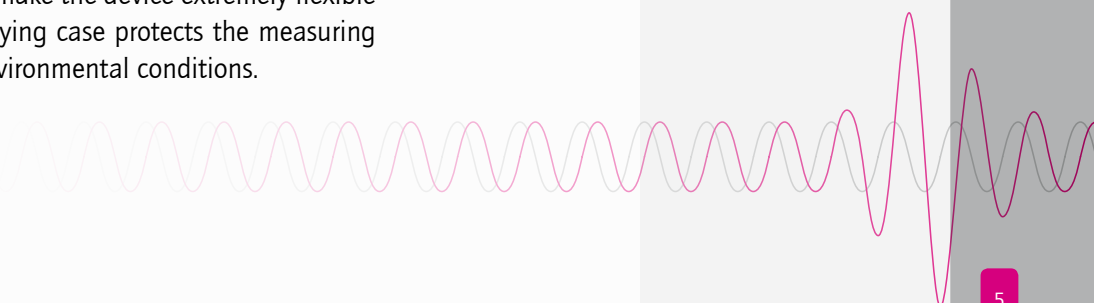

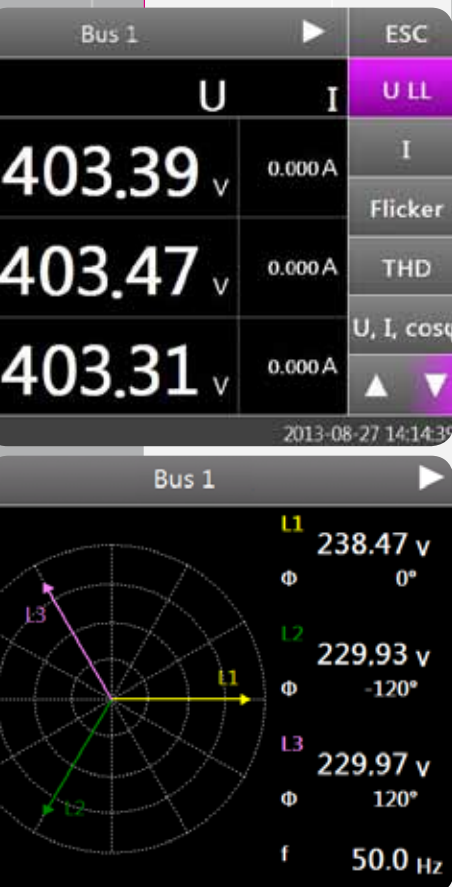

INPUTS AND OUTPUTS

Safe to operate even under extreme conditions

All analog and binary inputs and outputs and all interfaces are galvanically isolated and meet stringent occupational health and safety requirements. Their excellent immunity to electromagnetic disturbances ensures smooth operation even when conditions are extreme.

Analog inputs

EPPE CX|PX analog channels are generally sampled at a rate of 200 kHz. Because of the absolutely linear frequency response, all the inputs provide high accuracy (< 0.05%) across the entire measuring range.

Features:

- 16 bit A/D converter
- Sampling rate 200 kHz
- Accuracy < 0.05% (of range)
- Overcurrent-protected up to 500 A for max. 1 sec.

The following measurement ranges are available:

EPPE CX

- 4 x 600 V Ph-N, 4 x 40 A
(measurements on protection or measurement transformers)
- 4 x 600 V Ph-N, 4 x 600 V Ph-N
(measurements on 2 voltage systems)
- 4 x 600 V Ph-N, 4 x 3 V Ph-N
(measurements via external current sensors)

EPPE PX

- 4 x 600 V Ph-N, 4 x 32 A, 4 x 3 V Ph-N
(measurements on protection or measurement transformers and via external current sensors)

Binary inputs and outputs

The binary inputs are divided into groups, each of which has a common reference point. The special input circuitry of the binary inputs is designed for operation with voltages between 24 V and 300 V and effectively suppresses the detection of transients which can be caused by switching operations, for example.

Freely configurable relay outputs can be used for the indication of status signals, alarm signals or limit value violations to control systems, for example.

Features CX:

- 14 binary inputs
- 2 groups of 7 channels
- Response threshold: 24...300 VDC
- Resolution: 0.1 ms
- 2 potential-free relay contacts
- 6 electronic relay outputs

Features PX:

- 8 binary inputs
- 2 groups of 4 channels
- Response threshold: 24...300 VDC
- Resolution: 0.1 ms
- 2 potential-free relay contacts

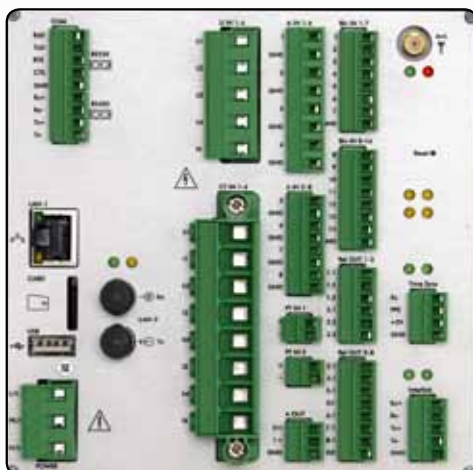

EPPE CX (4 x voltage / 4 x current)

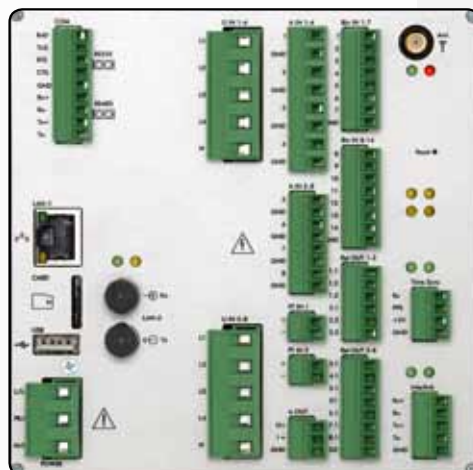

EPPE CX (8 x voltage)

State	Name
1	Breaker1
1	Breaker2
1	Breaker3
0	Breaker4
1	Machine1
1	Machine2
1	Machine3
0	Machine4
0	Machine5
0	BinInp 10
0	BinInp 11
0	BinInp 12



Sensor measuring module

The storage and analysis of environmental factors are becoming increasingly important for measuring systems which are used for monitoring and analysis, particularly for those used in renewable power generating systems (PV systems, wind power plants, etc.).

Factors such as light irradiation, ambient temperature, module temperature, humidity, wind speed, wind direction, sound intensity, generator temperature, etc. can provide helpful information for analysis or fault diagnostics.

The **EPPE CX | PX** power quality analysers enable these measurement values to be recorded with the aid of sensor measurement inputs and can issue alarm signals to the user if pre-defined limit values are exceeded.

In the case of a malfunction, this additional measurement data is helpful for the purposes of analysis and for the development of remedial measures. The sensor measurement inputs also allow a further current measurement to be carried out which can be used for the identification and elimination of leakage currents in a plant on the basis of differential current measurements, for example.



EPPE PX

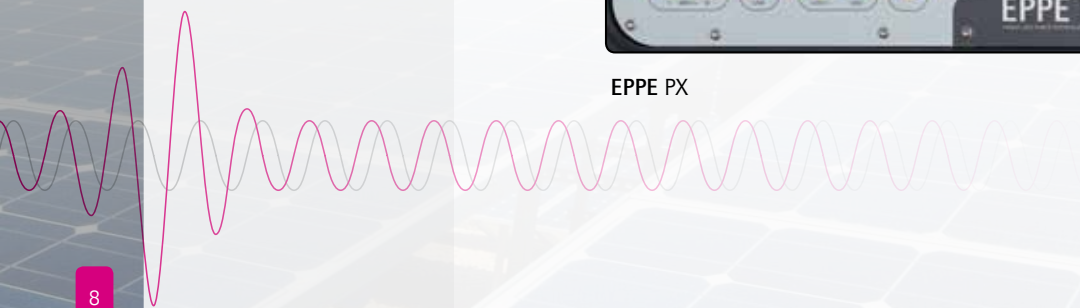

The following analog inputs, temperature inputs and analog outputs are provided by the sensor measuring module:

EPPE CX
4 analog inputs (sampling rate 200 KHz) Measuring range can be selected: <ul style="list-style-type: none"> ■ 300 V (voltage measurement, sensor technology) ■ 10 V (sensor technology) ■ 2 V (current sensors, current clamps) ■ 20 mA (sensor technology)
4 analog inputs (sampling rate 100 Hz) Measuring range can be selected: <ul style="list-style-type: none"> ■ 10 V (sensor technology) ■ 20 mA (sensor technology)
2 temperature inputs (sampling rate 100 Hz) <ul style="list-style-type: none"> ■ Pt100, Pt500, Pt1000 ■ Measuring range -50...120°C
1 analog output (process output) Output signal can be selected: <ul style="list-style-type: none"> ■ 0...3 V ■ 4...20 mA (passive)

EPPE PX
4 analog inputs (sampling rate 10 kHz) Measuring range: <ul style="list-style-type: none"> ■ 10 V (sensor technology)
1 temperature input (sampling rate 100 Hz) <ul style="list-style-type: none"> ■ Pt1000 ■ Measuring range -20...80°C
1 analog output (process output) Output signal: <ul style="list-style-type: none"> ■ 0...10 V

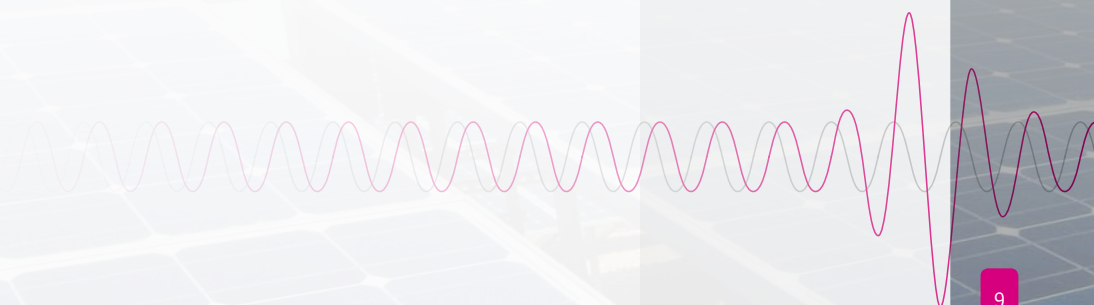
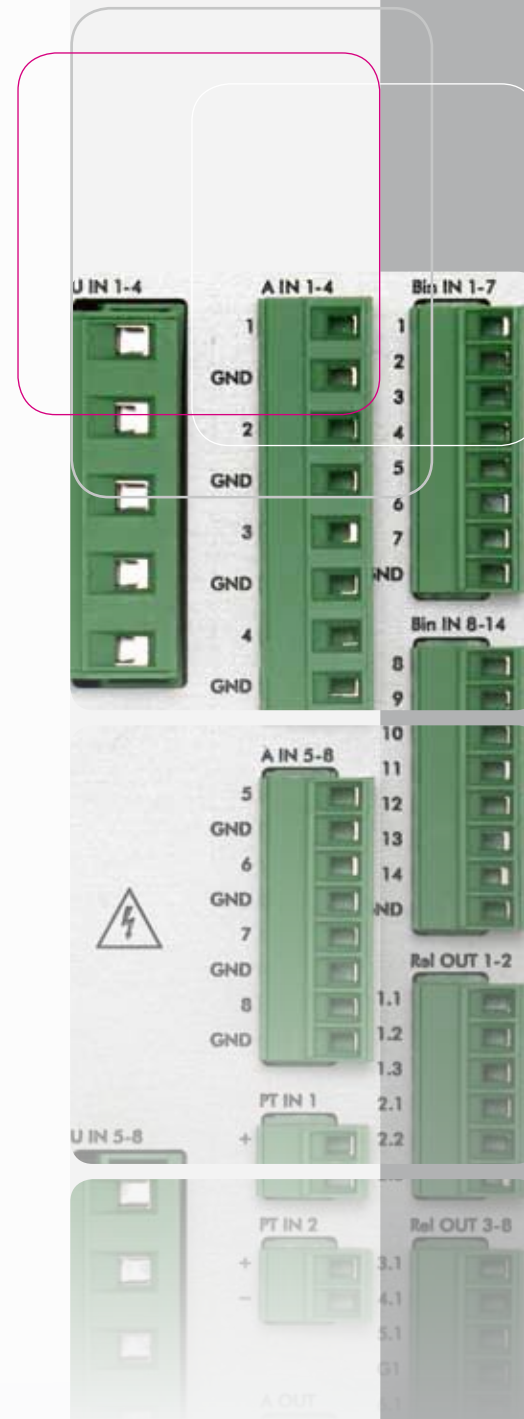

COMMUNICATION

Dual-processor system

EPPE CX | PX feature an integrated dual-processor system with two separate processors for the user interface and for the communications interfaces. This is the only way to ensure user-friendly operation, fast and reliable data transfer and easy integration into any network.

Transfer of parameters by USB flash drive

If neither a wired nor a wireless communication network is available, parameters can also be transferred directly using a USB flash drive. Saved measurement data can also be transferred quickly and easily to a USB flash drive without a direct communication connection.

Communication interfaces

The measuring systems provide the following interfaces for integration in communication networks:

EPPE CX

- Electric Ethernet
- Optical Ethernet (optical fibre)
- USB (active/passive)
- RS485
- RS232
- Integrated web server
- GSM/GPRS modem
- UMTS router

EPPE PX

- Electric Ethernet
- USB (active/passive)
- Integrated web server
- GSM/GPRS modem
- UMTS router

Integrated web server

EPPE CX | PX have an integrated web server which allows users to access relevant measurement data from any PC with any Internet browser. There is no need to install special software.

Data communication via UMTS router

As reliance on renewable energy sources grows, increasing numbers of power quality analysers are used in plants which do not have a wired communication network. Automatic data download using a mobile network via UMTS, for example, is recommended as an alternative to downloading data onto a USB flash drive.

This means that communication and data transfer are fully independent of any kind of wired infrastructure. What is more, even in rural areas and small towns it is possible to reach a high data transmission rate (of up to 100 Mbit/s) when downloading the measurement data. The UMTS router establishes an Internet connection and the data can be transferred easily and reliably to a central server (database) by means of a VPN tunnel. The portable **EPPE PX** features separate connections to supply power to a UMTS router.

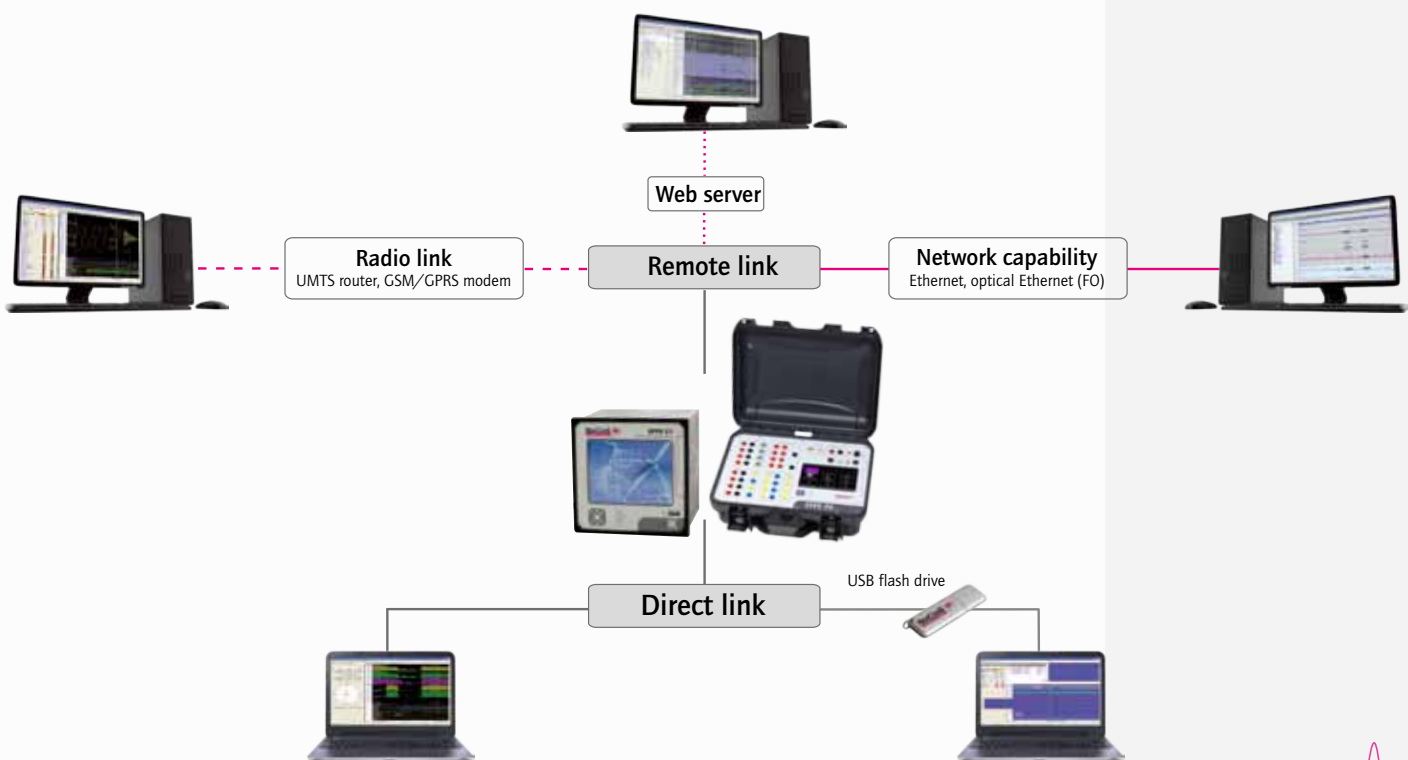

IEC 61850 || Modbus

For integration in substation control and protection or for the exchange of data with other systems, EPPE CX can use a range of data protocols, including IEC 61850 and Modbus. These communications services run in parallel, enabling data to be exchanged quickly between different systems.



DATA MEMORY

The measurement data can be recorded safely and reliably in the internal flash memory and can be transferred quickly and conveniently to a PC. No measurement data is lost, even when there is an interruption to the power supply.

POWER SUPPLY

Power supply units

The standard wide-range power supply unit allows flexible powering. Additionally, EPPE CX features the option for the device to be equipped with various different DC power supply units.

EPPE CX:

- Wide-range power supply unit:
85...265 VAC / 90...350 VDC
- Optional DC power supply units:
9...18 VDC , 18...36 VDC, 36...72 VDC

EPPE PX:

- External wide-range power supply unit
100...240 VAC (100...350 VDC)
- Internal DC power supply unit:
9...18 VDC

Internal emergency power supply

The device is automatically supplied with power for a period of up to 8 seconds should there be a short-term interruption to the voltage supply.

The emergency power supply is completely maintenance-free! It is not necessary for the battery of the EPPE CX | PX to be replaced by the manufacturer as is often the case with similar systems after just one year.

External UPS

An external mini UPS can be used to reliably ensure an uninterrupted power supply. It is easy to install and can provide back-up even when power failures continue for a considerable length of time. Appropriately dimensioned power banks can be used with the portable EPPE PX for additional external voltage backup over periods of several hours.

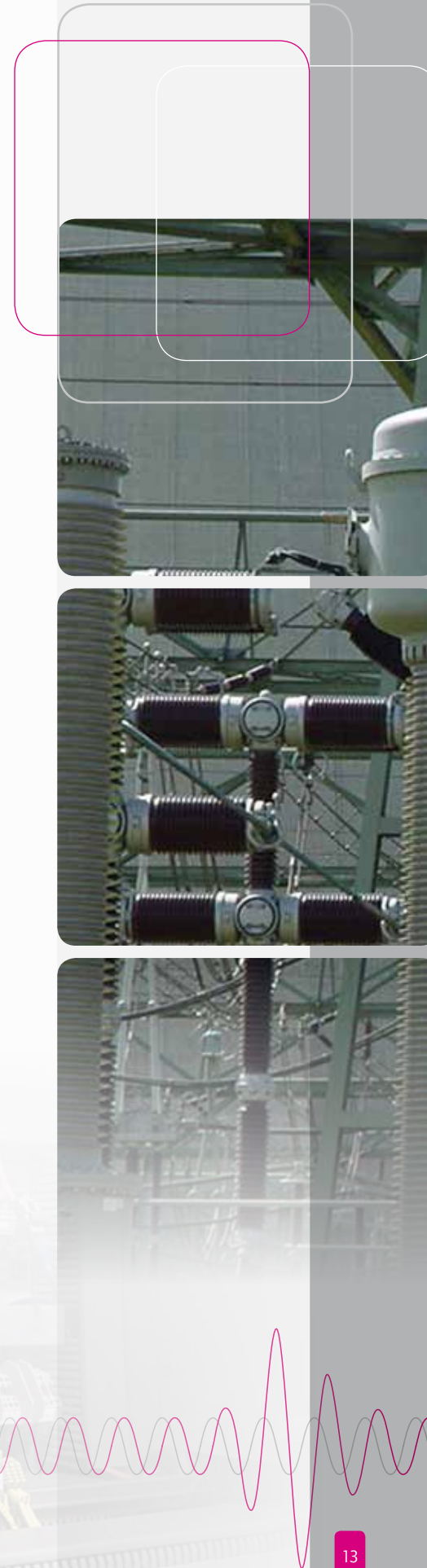

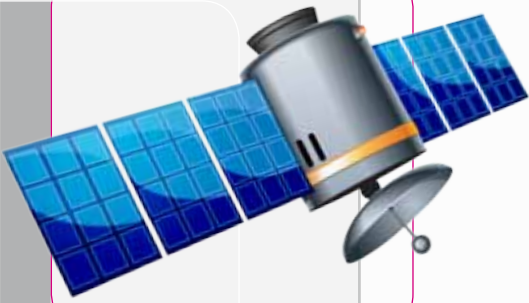

TIME SYNCHRONIZATION

Power quality analysis and fault analysis with full area coverage call for precise time synchronization. Only when measured values are recorded by a number of devices absolutely simultaneously, is it possible to compare them with one another and analyse them correctly.

EPPE CX | PX can use the following methods of time synchronization:

EPPE CX

- GPS
- DCF77
- NTP/SNTP
- IRIG-B
- Synchronisation to PC time
- Seconds and minutes pulse
- KoCoS-Interlink interface

EPPE PX

- GPS
- DCF77
- NTP/SNTP
- Synchronisation to PC time
- KoCoS-Interlink interface

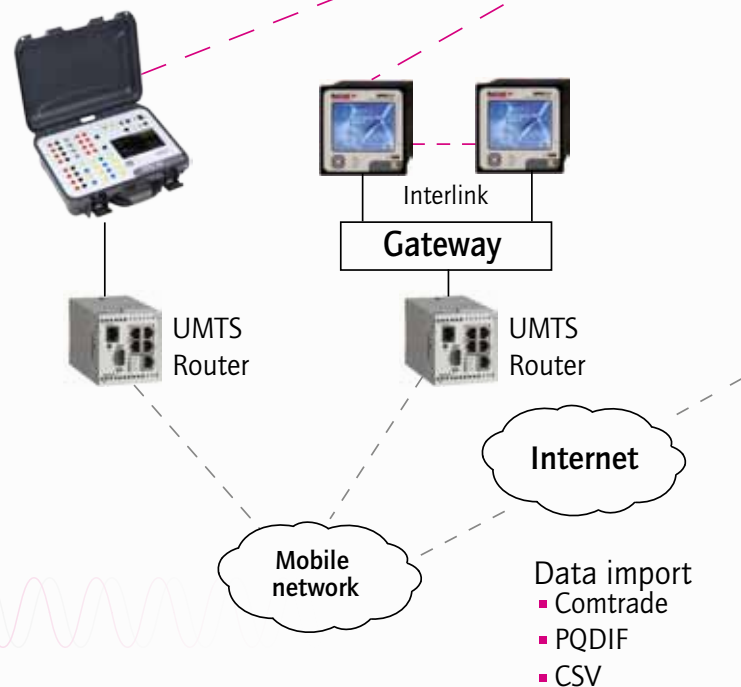

The KoCoS-Interlink interface can be used to synchronize the time of a number of EPPE devices and to pass on trigger information. This results in a significant reduction in costs as only one measuring device per location needs to be synchronized as the „master“ system. The cross-triggering function can also be used to start fault recordings absolutely simultaneously on a number of EPPE systems at once.

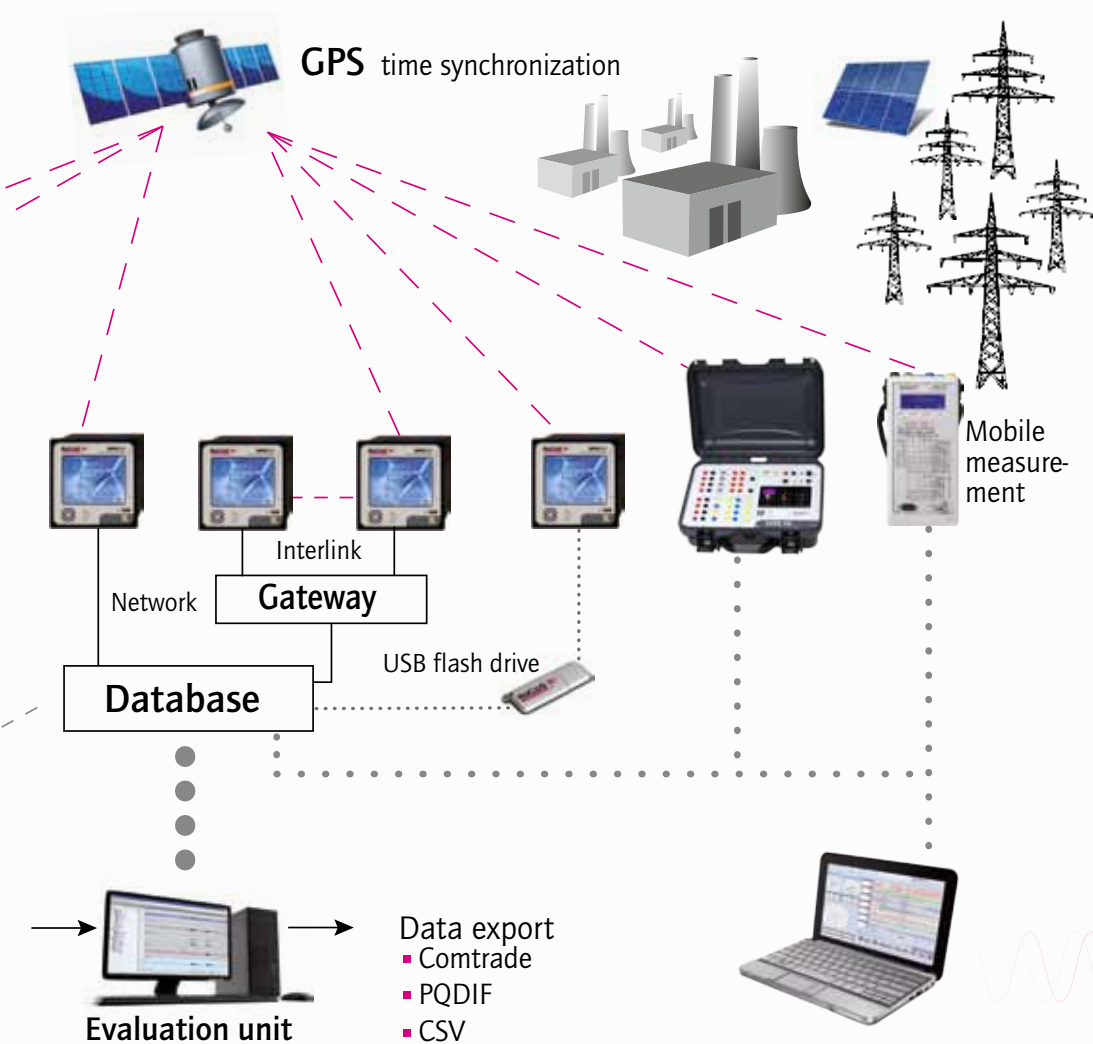

RECORDING FUNCTIONS

Power quality recording

The continuous recording of all power system parameters allows comprehensive power quality analysis to DIN EN 50160 or quality criteria defined by the individual user.

Characteristic values are captured and calculated to IEC 61000-4-30 class A, IEC 61000-4-7 and IEC 61000-4-15. Because quality reports can be evaluated and created automatically as PDF files, it is easy to provide proof of quality whenever required, even without specialist knowledge.

Continuous data recording

The data logger function records measurement data continuously. The recorded data can be downloaded to a central computer without interrupting the measurement.

As a result, data can be recorded continuously for a number of years. The averaging intervals can be configured in line with individual requirements. For each averaging interval, the mean value for the given time and the highest and lowest single RMS values for a system cycle are recorded with an exact time stamp. Long-term recordings provide comprehensive information on the entire power system, expose slow changes, as can result from a changing load or generator structure, and reveal potential for energy savings.

Event recording

Event recording provides information on the time, level and duration of limit value violations and a classification of events to EN 50160, for example. If required, the event signatures can also be recorded with a time resolution of half a period.

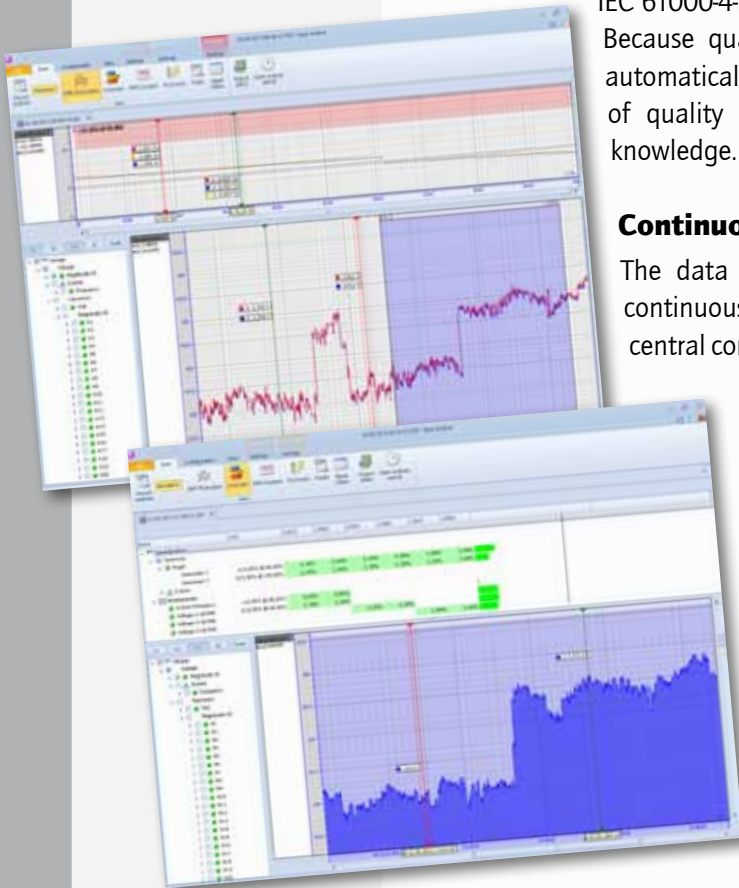

Fast fault recording for power system faults

When a limit value violation occurs, all analog and binary signals are recorded with a configurable resolution of 100 Hz to 30 kHz. The recording comprises separately configurable time windows for pre-fault, fault and post-fault periods. The fault recording duration can either be set to a fixed length or can be controlled by the actual duration of the event.

Slow fault recording

In addition to the analog and digital signals which are measured directly, the RMS fault recorder can also record all the quantities calculated on the basis of these signals, such as frequency, unbalance, positive sequence system, negative sequence system and zero sequence system, active power, reactive power and apparent power, harmonics etc. The sampling rate can be set between 1 Hz and double the system frequency (100 Hz/120 Hz). The recording is ideal for detecting and assessing slow processes, such as power swings, or for generator monitoring.

Recording of digital events and states

Binary inputs are primarily used to read in signals from protection relays, circuit breaker positions or machine conditions, for example, which are of decisive importance for the analysis of fault records. The binary inputs can also be used to trigger fault records in order to obtain a high-resolution record of the state of the power system at the moment of switching.

Energy meter

Power consumption can be monitored using the built-in energy meter with accuracy class 0.2S and optimised with the aid of long-term trend analysis. Active, reactive and apparent energy can be recorded and analysed extremely precisely.

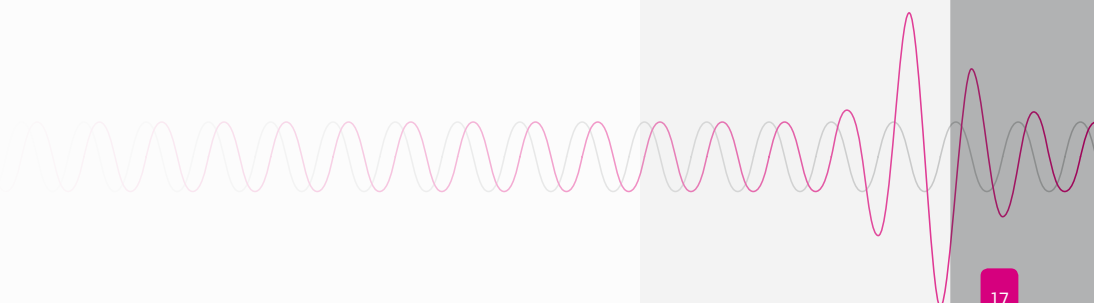

OPERATING CONCEPT

Operation via touch screen

The device can be operated easily using the ergonomic touch screen. All functions and measured value displays can be selected directly from the main menu. All important measured values and status information can be seen at a glance. Alternatively, the device can also be operated with the aid of the function keys.



Limit value violations and fault records can be displayed and analysed directly on the screen of the EPPE PX, allowing on-site analysis at the measurement location without a PC.

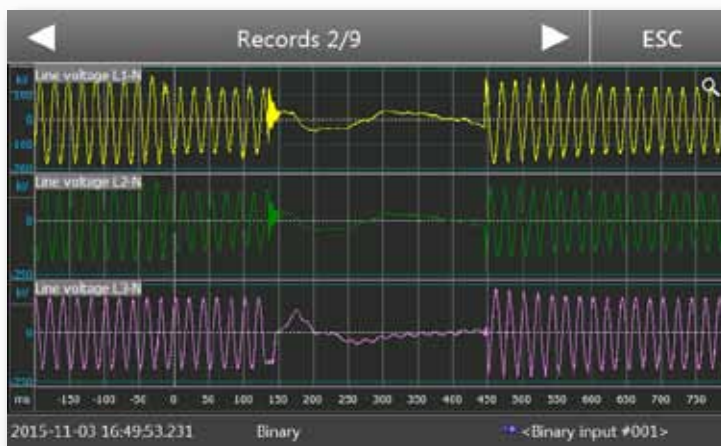

Operation and management via PC

As well as using the touch screen, it is also possible to operate and configure EPPE CX and PX with the ergonomic and easy-to-understand software for Windows® operating systems. The EPPE operating software also contains comprehensive analysis functions for the evaluation of the measurement data. Fully automated operation is also possible, including fault analysis, evaluation in accordance with selected standards (e.g. EN 50160), report creation, export functions and message management.

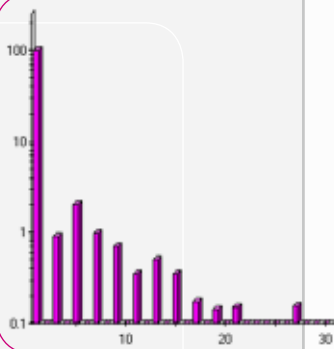

SOFTWARE FOR OPERATION AND EVALUATION

The ergonomic software designed in accordance with the Windows Fluent concept is geared to meet real-world requirements and can be put to a wide variety of different uses, ranging from the operation of an individual measuring device to the administration of complex groups of EPPE measuring devices. There are 3 versions of the software which differ in functionality and in the number of measuring instruments to be managed.

“Basic” EPPE operating software

- Functionality limited to power quality measurements in compliance with valid standards
- Management of up to 5 EPPE measuring instruments

“Professional” EPPE operating software

- Full range of functions
- Management of up to 5 EPPE measuring instruments

“Premium” EPPE operating software

- Full range of functions
- Management of an unlimited number of EPPE measuring instruments

The scope of delivery of **EPPE PX** includes EPPE software for operation and evaluation with a full range of functions for managing one measuring instrument.

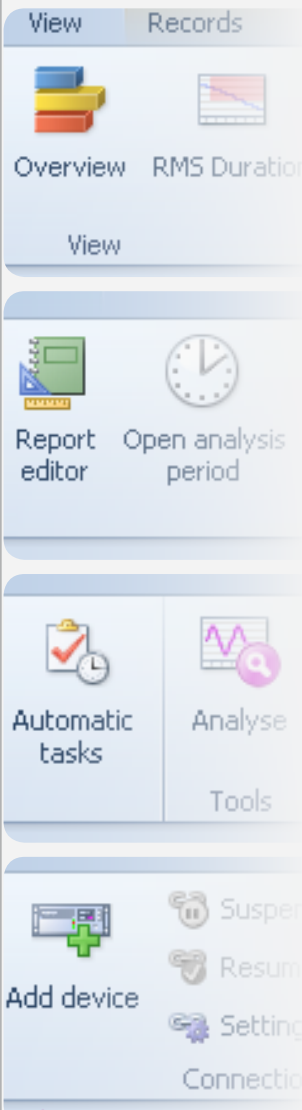

All versions of the software are very user-friendly and feature a variety of functions, including the following:

- Flexible configuration for optimum customization to a wide range of measurement tasks
- Remote configuration/administration
- Fully automatic operation of the measuring system with
 - remote data transmission
 - archiving of records in a database
 - printout or dispatch of fault reports and PQ quality reports
 - export to common PQ and fault record formats
 - online monitoring
- Easy-to-use analysis tool with automatic evaluation and assessment of power quality to international standards (e.g. EN 50160)
- Can be used with several screens (optimum overview, a wealth of information at a glance)

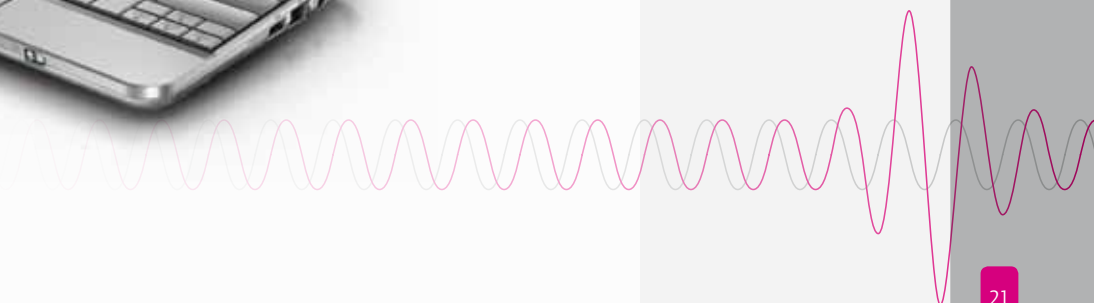

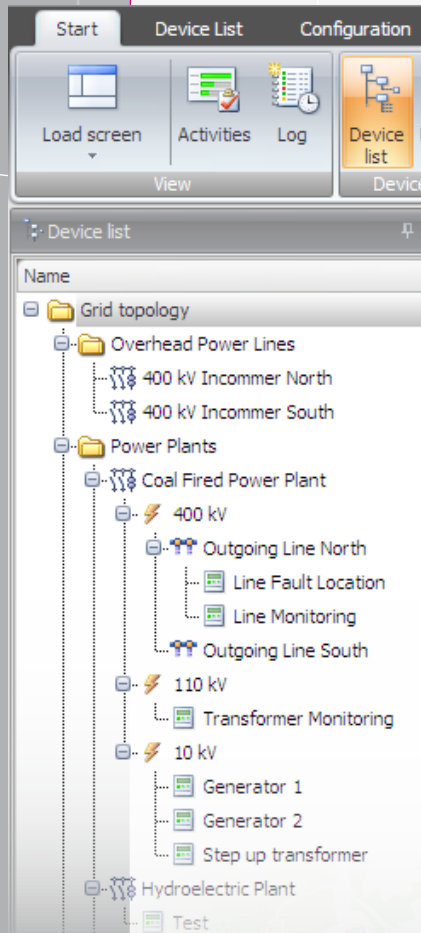

Device management

The operating software allows the connection and management of a large number of EPPE measuring devices.

The status information for all connected devices is displayed in a clearly structured device list, device settings can be adjusted quickly and easily.

In addition, graphical device management allows measuring devices and their status information to be displayed on a map, for example. This provides the user with an optimum overview of all measurements, even in comprehensive monitoring systems.

Online monitoring

All measured or calculated quantities can be called up online and displayed on a PC without affecting the data recording which is currently in progress. The measurement values can be combined within display windows, rather as in a control centre system. In addition to numerical display, the system also provides a range of graphical options, including analog pointer instruments, vector diagrams, bar graphs and oscilloscope displays.

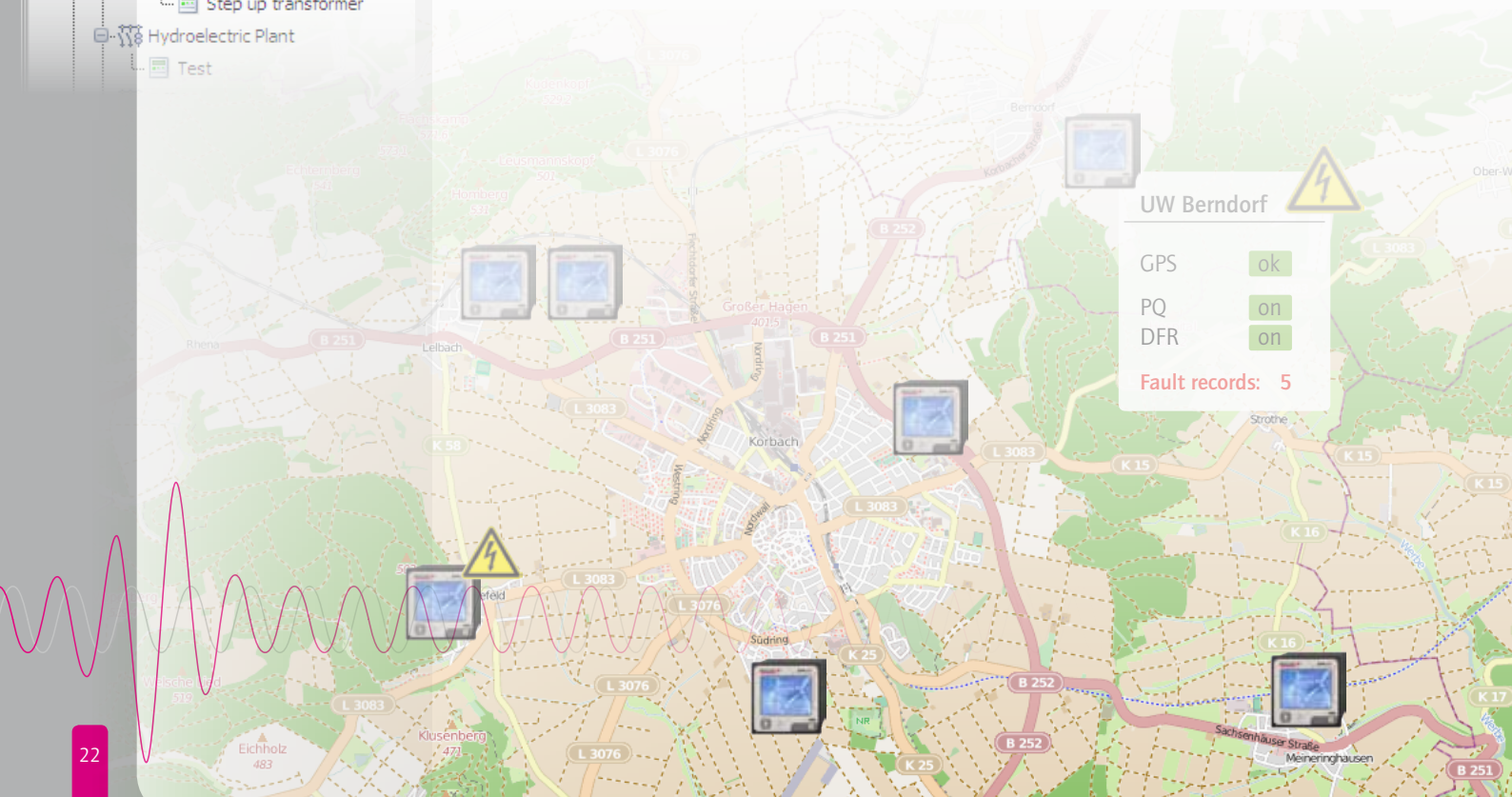

Configuration

The practical configuration module takes the actualities and requirements of modern power supply systems into account.

Templates which correspond to specific standards (e.g. EN 50160) can be selected for long-term recording and event analysis, so even users without specialist knowledge can conduct a full analysis of a power system. Recording parameters, such as the averaging interval or the selection of variables, can also be configured manually for customized power system analysis.

When using the fault recorder functionality, a wide range of parameters can be selected freely, including for example the sampling rate, recording duration, pre-fault and post-fault period and the variables for which triggers are to be defined.

Configuration options such as trigger inhibit, retrigger inhibit or trigger delay are available.

It is also possible to create logical links with the analog and binary measurement signals, providing monitoring options for PV plants or wind power plants, for example.

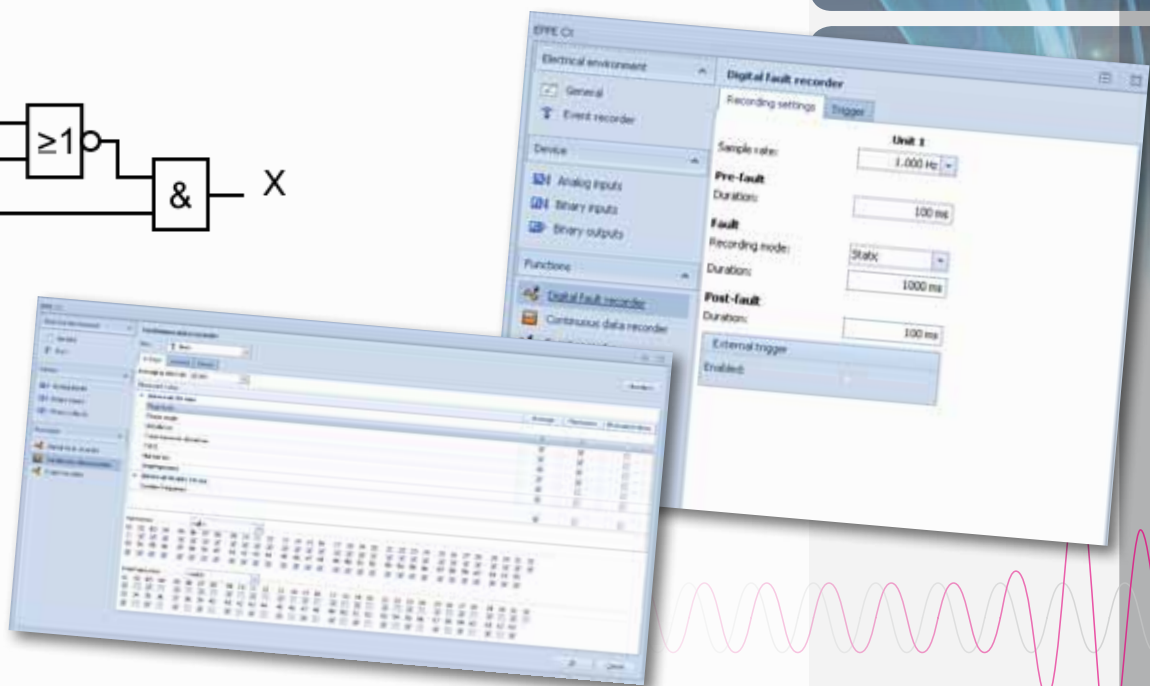
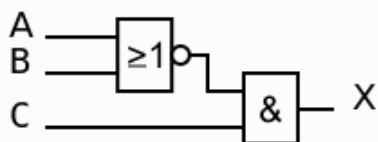

EVALUATION

Power system quality analysis

Power system and power quality analysis can also be carried out automatically to the selected standard (e.g. EN 50160). A number of analysis tools are provided for this purpose:

- Slow changes with trend analysis
- Event recording with signature display
- Flicker analysis
- Harmonic analysis
- Analysis of interharmonics
- Event classification and assessment (UNIPEDA, ITIC, etc.)
- Graphical display of extreme value duration distribution
- Table overview of limit value violations
- User-defined limit value and analysis settings
- Automatic generation of weekly, monthly, quarterly and annual reports
- Calculation and signal display for differential current measurements
- Useful zoom functions and variable scaling
- Superimposition of different signal characteristics
- Formulary and formula editor for the calculation of further power system quantities

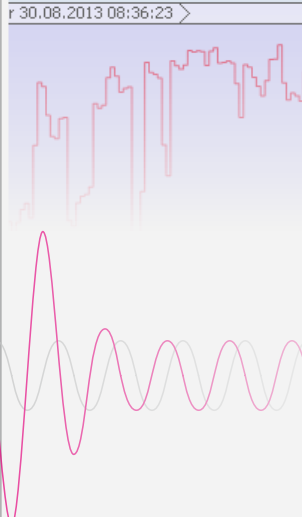
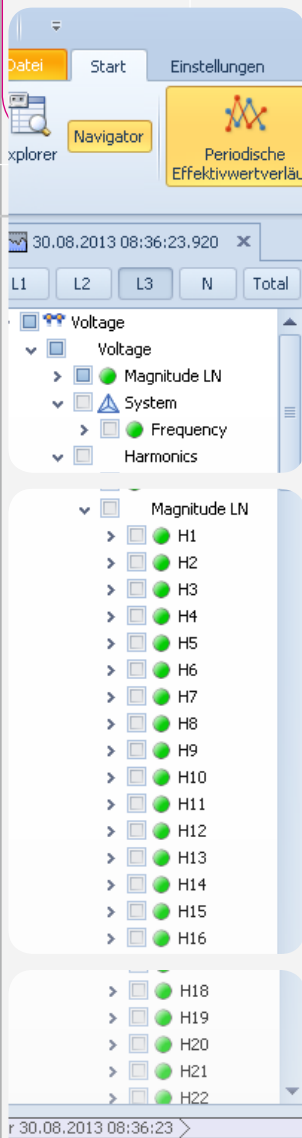

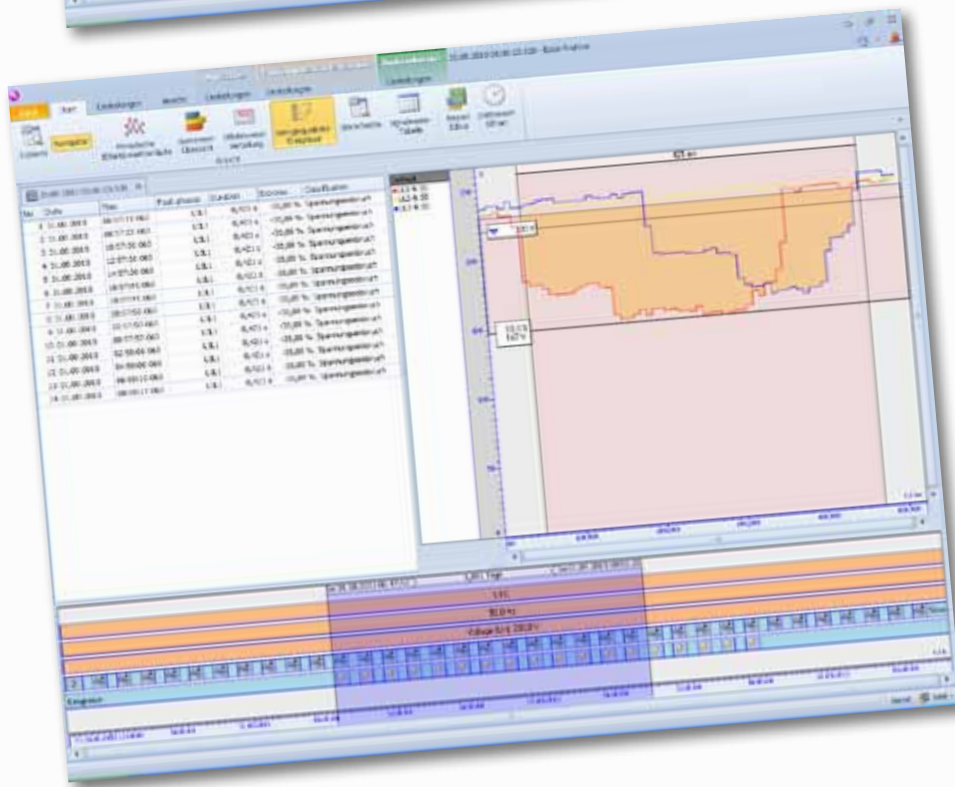
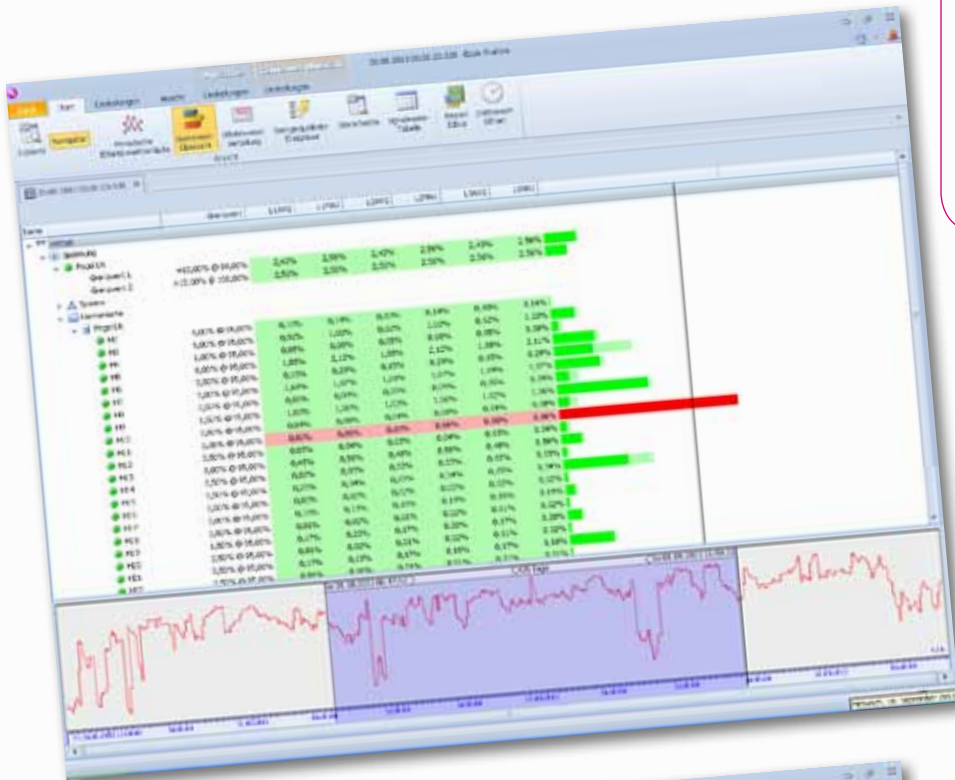

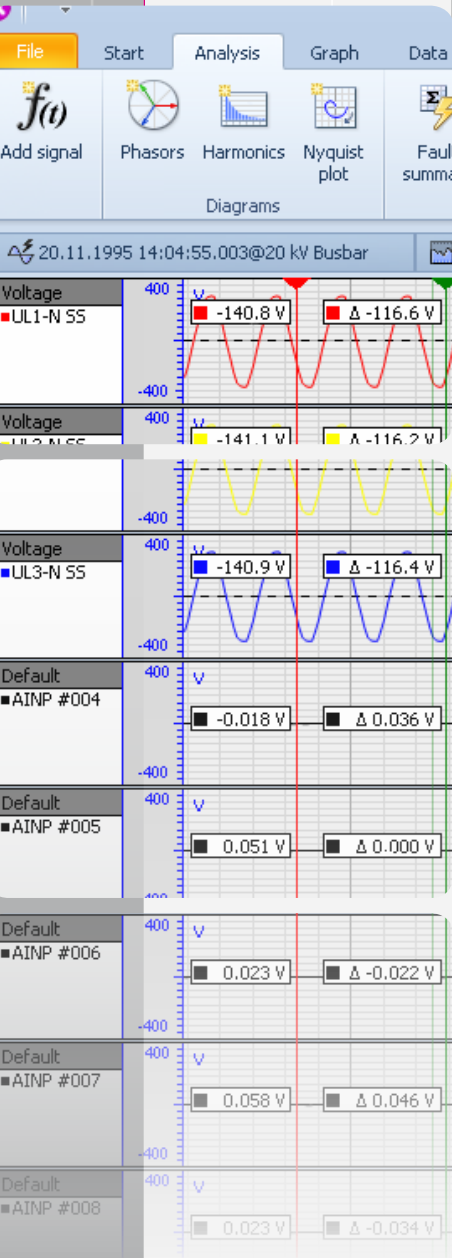

Evaluation of fault records

The software also contains a comprehensive range of powerful analysis tools for the assessment of fault records:

- Vector displays
- Harmonic analysis on the basis of full waves or to IEC 61000-4-7 with interharmonics
- Freely configurable absolute and delta measurement cursors
- Useful zoom functions and variable scaling
- Simultaneous display, superimposition and synchronization of more than one fault record
- Formulary and formula editor for the calculation of further power system quantities
- Individual report creation using the clipboard
- Automatic report creation

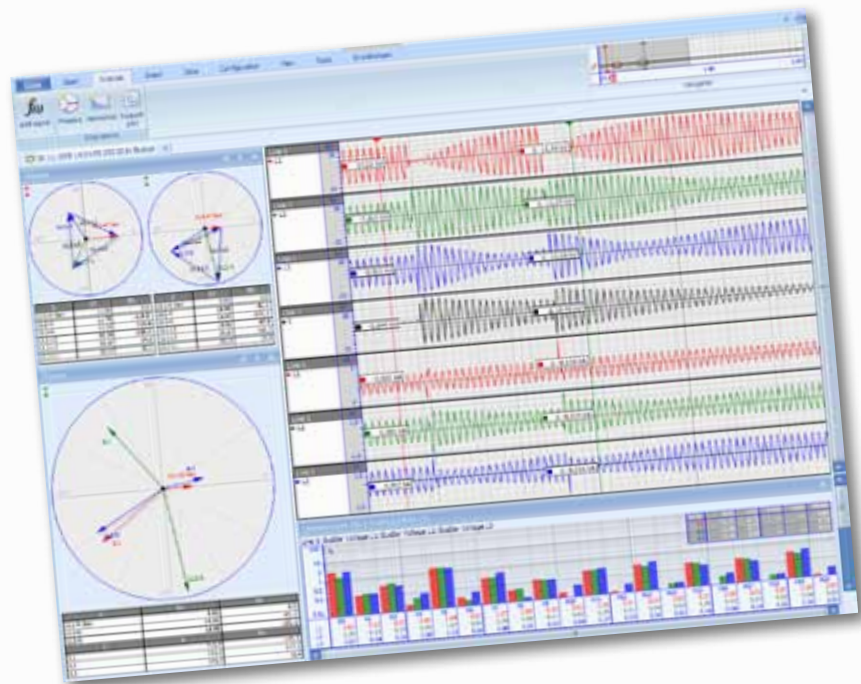

Mathematical signal analysis

A formula editor can be used to make further mathematical calculations within recordings. The results are added to the long-term record or the fault record as an additional signal.

Data formats

Import and export functions enable data to be exchanged between different systems using standard PQDIF, COMTRADE, CSV and XML (Nequal) file formats.

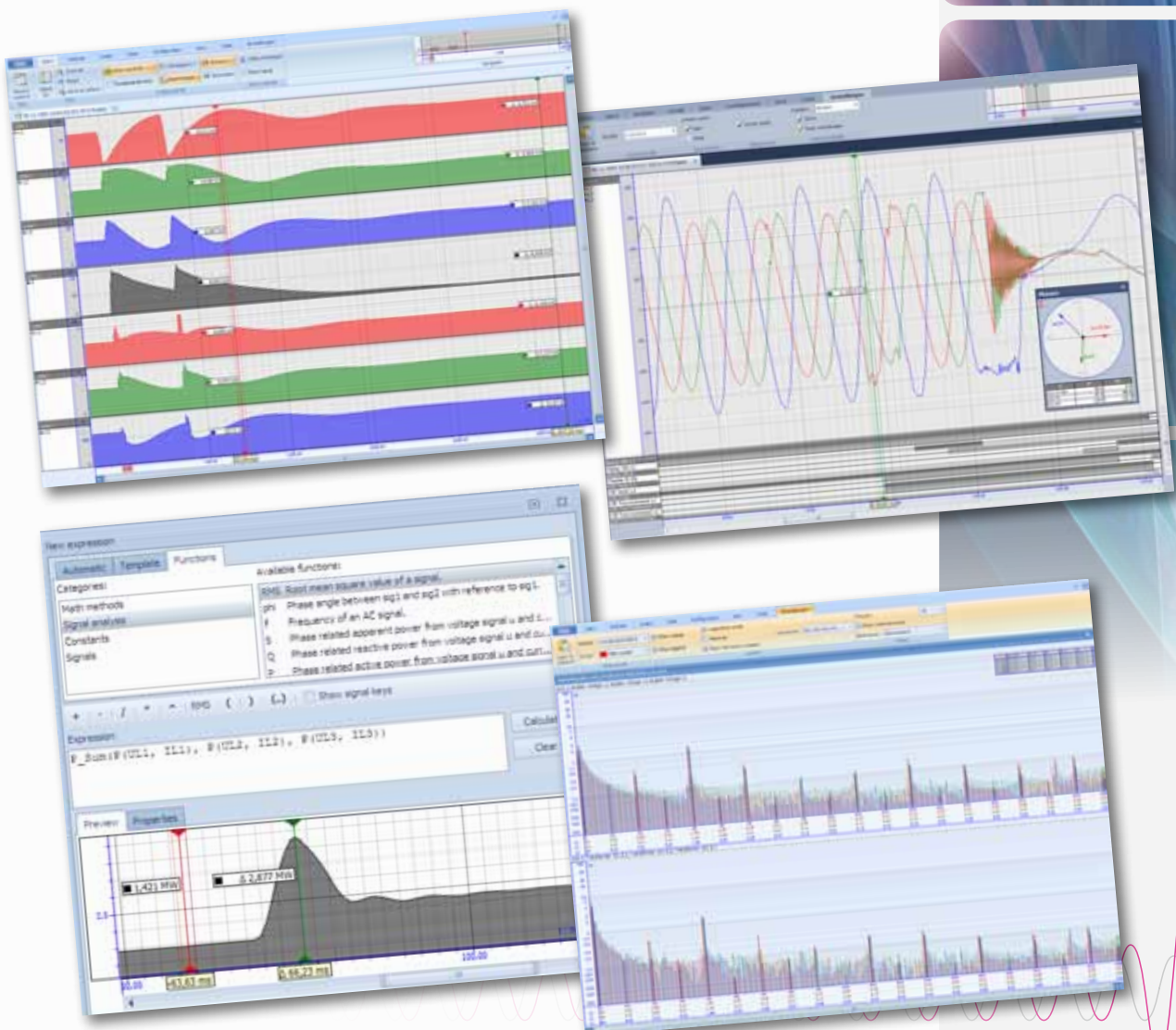

INSTALLATION

The **EPPE CX** measuring instrument is designed for panel mounting. A bracket system for DIN-rail mounting is available as an optional extra.

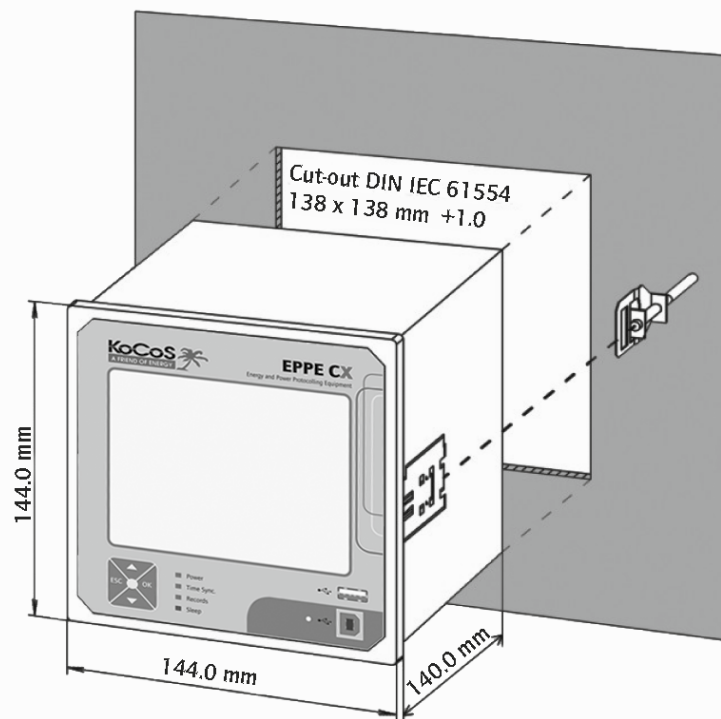

The **EPPE PX** is a portable measuring device integrated in a rugged plastic case.



A wide range of accessories simplifies various different measurement tasks.

Connection cables



GPS antenna



Temperature sensor



Flexible current probes



Flexible mini current probes



Current clamps



Dolphin clips



Magnetic voltage tap



Flat measurement clips



Claw clips



Terminal adapters



Fuse adapter with high-breaking-capacity fuse



Accessory case, outdoor



TECHNICAL DATA EPPE CX

General description	Multi-processor system	Digital signal processor (DSP), 32 bit, 330 MHz for processing signals and processes in real time	
		Communication processor, 32 bit, 624 MHz for mass data storage, simultaneous data communication using different interfaces and protocols, web server functionality and stand-alone operation	
	User controls and displays	4 status LEDs for trigger and status display 5" colour graphical display with touch screen and 4 function keys	
	Data memory	Flash RAM for measurement data storage Flash RAM for firmware	
	Quality system	Developed and manufactured to DIN ISO 9001:2000	
Power supply	Operating voltage	Type 1: 90...350 VDC and 85...265 VAC; 47...63 Hz Type 2: 9...18 VDC Type 3: 18...36 VDC Type 4: 36...72 VDC	
Analog inputs	Number	max. 12	
	Resolution/sampling	16 bit/200 kHz	
	Accuracy	0.05 %	
Analog module 1	Voltage inputs	Number	4
		Measuring range	600 VAC / ± 848 VDC
	Current inputs	Number	4
		Overload	100 AAC for max. 3 s, 500 AAC for max. 1 s
Analog module 2	Voltage inputs	Number	8
		Measuring range	4 x 600 VAC / 4 x 600 VAC 4 x 600 VAC / 4 x 3 VAC (current sensors)
Sensor module (optional)	Measurement inputs Group 1	Number	4, sampling frequency 200 kHz
		Accuracy	0.05% of range
		Measuring range	300 VAC / ± 424 VDC 7.07 VAC / ± 10 VDC 2 VAC / ± 2.82 VDC 4...20 mA
	Measurement inputs Group 2	Number	4, sampling frequency 100 Hz
		Accuracy	0.5% of range
		Measuring range	7.07 VAC / ± 10 VDC 4...20 mA
	Temperature measurement inputs	Number	2, sampling frequency 100 Hz
		Sensor type	Pt100, Pt500, Pt1000
		Measuring range	-50°C...120°C
	Analog outputs	Number	1
		Output range	0...3 VDC 4...20 mA (passive)

Binary inputs	Number	14
	Resolution	0.1 ms
	Activation range	24...300 VDC
Binary outputs	Number	2 mechanical relay outputs, configurable as NC or NO contacts; 6 electronic outputs
	Switching capacity	Mechanical relays: 220 VDC, 2 A Electronic relays: 60 VAC/DC, 400 mA
Time synchronization	Interfaces	Internal real-time clock, NTP/SNTP, IRIG-B, internal GPS receiver, external GPS central clock, DCF 77, seconds or minutes pulse, Interlink interface for the synchronization of EPPE devices with each other
Data communication	Interfaces	Standard: 1 x RS232, 1 x RS485 2 x USB-A, 1 x USB-B 1 x 10/100 Mbit Ethernet (RJ 45) Optional: 1 x 10/100 Mbit optical Ethernet (ST II)
	Protocols	Standard: TCP/IP, Modbus TCP, GSM, GPRS Optional: IEC 61850, IEC 60870-5-103, Profibus
Overview of functions	Recording functions	Power quality analyser, class A Continuous data recording Event data recording RMS fault recorder, sampling rate from 1 Hz to 120 Hz Digital fault recorder, sampling rate from 100 Hz to 30 kHz Sensor recording Energy meter Logical functions
	Standards	IEC 61000-4-30 class A IEC 61000-4-7 harmonics and interharmonics IEC 61000-4-15 flicker EN 50160, IEEE 519, IEEE 1159
Environment	Housing	For panel-mounting, optional DIN-rail mounting
	Protection class	IP 52 (front panel)
	Dimensions (W x H x D)	144 x 144 x 140 mm
	Other	RoHS-compliant
Operating software	EPPE software for Windows® XP, 7, 8.1, 10 (32 and 64 bit), Windows® Server 2012	

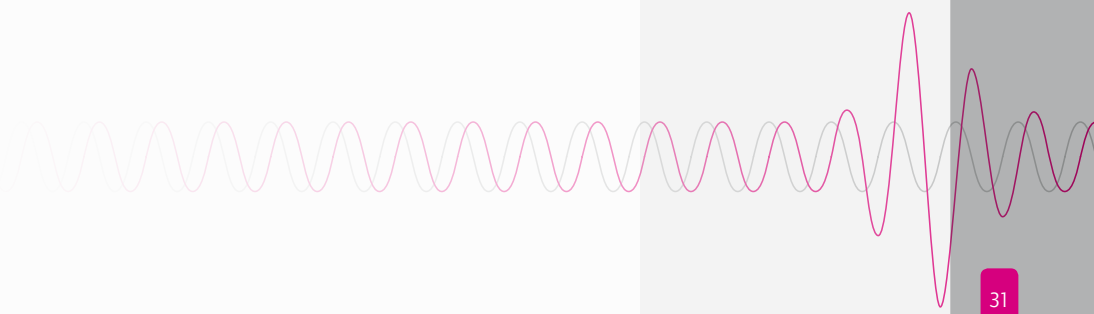

TECHNICAL DATA EPPE PX

General description	Multi-processor system	Digital signal processor (DSP), 32 bit, 330 MHz for processing signals and processes in real time		
		Communication processor, dual-core 32 bit, 1 GHz for mass data storage, simultaneous data communication using different interfaces, web server functionality and stand-alone operation		
	User controls and displays	5 status LEDs for trigger and status display 7" colour graphical display with touch screen and 4 function keys		
	Data memory	Flash RAM for measurement data storage Flash RAM for firmware		
	Quality system	Developed and manufactured to DIN ISO 9001:2000		
Power supply	Operating voltage	External power supply unit: 100...240 VAC (100...350 VDC), 47...63 Hz Internal power supply unit: 9...18 VDC		
Analog inputs	Number	12		
	Resolution/sampling	16 bit/200 kHz		
	Accuracy	0.05 %		
	Voltage inputs	Number	4, galvanically isolated	
		Measuring range	600 VAC / ± 848 VDC	
	Current inputs	Number	4	
		Measuring range	32 AAC	
		Overload	100 AAC for max. 3 s, 500 AAC for max. 1 s	
	Current sensor inputs	Number	4	
		Measuring range	4 x 3 VAC	
Sensor inputs	Measurement inputs	Number	4, sampling frequency 10 kHz	
		Accuracy	0.05% of range	
		Measuring range	7.07 VAC / ± 10 VDC Optional: 4...20 mA (adapter)	
	Temperature measurement inputs	Number	1, sampling frequency 100 Hz	
		Sensor type	Pt1000	
		Measuring range	-20°C...80°C	
Analog output	Voltage output	Number	1	
		Output range	0...10 VDC	

Binary inputs	Number	8
	Resolution	0.1 ms
	Activation range	24...300 VDC
Binary outputs	Number	2 mechanical relay outputs configurable as NO contacts
	Switching capacity	Mechanical relays: 220 VDC, 2 A
Time synchronization	Interfaces	Internal real-time clock, NTP/SNTP, internal GPS receiver, DCF 77, Interlink interface for the synchronisation of EPPE devices with each other
Data communication	Interfaces	Standard: 1 x USB-A, 1 x USB-B 1 x 10/100 Mbit Ethernet (RJ 45)
Overview of functions	Recording functions	Power quality analyser, class A Continuous data recording Event data recording RMS fault recorder, sampling rate from 1 Hz to 120 Hz Digital fault recorder, sampling rate from 100 Hz to 30 kHz Sensor recording Energy meter Logical functions
	Standards	IEC 61000-4-30 class A IEC 61000-4-7 harmonics and interharmonics IEC 61000-4-15 flicker EN 50160, IEEE 519, IEEE 1159
Environment	Housing	Carrying case
	Protection class	IP 65 (closed)
	Overvoltage category	CAT IV
	Dimensions (W x H x D)	424 x 340 x 173 mm
	Other	RoHS-compliant
Operating software	EPPE software for Windows®7, 8.1, 10 (32 und 64 bit)	

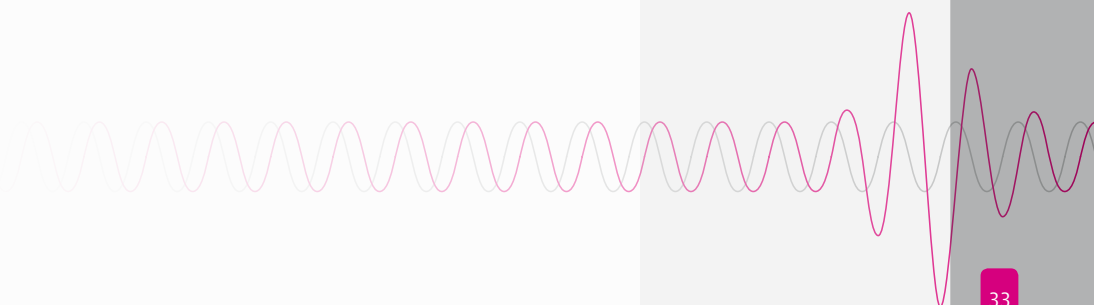

PRODUCT OVERVIEW EPPE CX

Standard Measuring Systems

Article number:

Power quality analyser EPPE CX - IDC	4155
4 current und 4 voltage inputs (40 AAC / 600 VAC L-N); power supply unit (36-72 VDC)	
Power quality analyser EPPE CX - IAC	4156
4 current und 4 voltage inputs (40 AAC / 600 VAC L-N); power supply unit (85-265 VAC / 90-350 VDC)	
Power quality analyser EPPE CX - UAC	4157
8 voltage inputs (600 VAC L-N); power supply unit (85-265 VAC / 90-350 VDC)	
Power quality analyser EPPE CX - UDC	4158
8 voltage inputs (600 VAC L-N); power supply unit (36-72 VDC)	

Communication interfaces:

Ethernet RJ45, USB (active/passive), RS232, RS485

Time synchronization:

Internal GPS/DCF receiver, Interlink interface, input for seconds or minutes pulse, IRIG-B signal input

14 binary inputs

8 relay outputs

Replaceable 2 GB memory (micro SD card)

5" colour graphical display with touch screen

Measurements according to IEC 61000-4-30 / EN 50160

Protocols: TCP/IP, Modbus TCP, GSM, GPRS

Software

Basic EPPE software	4153
Professional EPPE software	4152
Premium EPPE software	4151

Accessories

GPS antenna with magnetic base	11679
GPS antenna for installation on a building with surge protector and antenna lead	11558
DCF 77 antenna system	11681
Flexible current probe ACP 3000 (switchable 30/300/3000 A)	4148
Passive AC current clamp (switchable 20/200 A)	4168
Passive AC current clamp 10 A	4169
External analog modem	11521
External GSM modem	4109
External UPS	4167
DIN-rail mounting bracket	4145
Terminal adapter TA, 25 pieces	1171

Operating PCs

Portable operating PC	6065
Stationary operating PC	11630
Stationary operating PC for 19" rack mounting	6932
Server (tower)	4179
Server (rack) for 19" rack mounting	4178

Configurable measuring system

The following order code is to be used for ordering the configurable EPPE CX measuring system:

Description	Order code				
	EPPE CX -	-	-	-	-
Power quality analyser EPPE CX - basic unit Communication interfaces: Ethernet RJ45, USB (active/passive), RS232, RS485 Time synchronization: Internal GPS/DCF receiver, Interlink interface, input for seconds or minutes pulse, IRIG-B signal input 14 binary inputs 8 relay outputs Replaceable 2 GB memory (micro SD card) 5" colour graphical display with touch screen Measurements according to IEC 61000-4-30 / EN 50160 Protocols: TCP/IP, Modbus TCP, GSM, GPRS					
Power supply unit					
Wide-range power supply unit 85...265 VAC / 90...350 VDC	1				
9...18 VDC	2				
18...36 VDC	3				
36...72 VDC	4				
Analog measuring module					
4 voltage inputs and 4 current inputs (600 VAC L-N / 40 AAC)		A			
8 voltage inputs (600 VAC L-N)		B			
4 voltage sensor input and 4 current sensor inputs (600 VAC L-N / 3 VAC L-N)		C			
Sensor measuring module					
None		X			
8 analog inputs, 2 temperature inputs, 1 analog output		S			
Optical Ethernet interface (optical fibre)					
None			X		
Optical 10/100 Mbit Ethernet interface with STII connector			O		
Communication protocol					
None				X	
IEC 61850				I	
Profibus				P	
IEC 60870-5-103				F	

PRODUCT OVERVIEW EPPE PX

Article No.
4183

Power quality analyser EPPE PX including software for operation and evaluation

Analog inputs:

4 voltage inputs (600 VAC L-N), 4 current inputs (32 AAC), 4 current sensor inputs (3 VAC)

Sensor inputs / outputs: 4 sensor inputs (0...10 V), 1 temperature input, 1 process output

Power supply unit: 100...240 VAC (100...350 VDC), 9...18 VDC

Communication interfaces:

Ethernet RJ45, USB (active/passive)

Time synchronisation:

Internal real-time clock, GPS and DCF receiver, Interlink interface,

8 binary inputs

2 relay outputs

at least 2 GB data memory

7" colour graphical display with touch screen

Measurements according to IEC 61000-4-30 / EN 50160

Connection cable set for voltage inputs

Connection cable set for direct inputs for current measurement

Connection cable set for sensor inputs

Dolphin clip set, 4 x black / red / yellow / blue

25 terminal adapters

GPS antenna with magnetic base

Accessory case, standard

Accessories

Flexible current probe ACP3000 (switchable 30/300/3000 A).....	4146
Flexible current probe ACP300 (switchable 3/30/300 A).....	4502
Passive AC current clamp (switchable 20/200 A).....	4168
Passive AC current clamp 10 A.....	4169
Temperature sensor.....	4186
Connection cable for voltage output.....	4203
Connection cable set for binary inputs.....	4198
Connection cable set for binary outputs.....	4199
Fuse adapter with high-breaking-capacity fuse.....	4187
Terminal adapter TA, 25 pieces.....	1171
Flat measurement clip set, 4 x black.....	4192
Magnetic voltage tap set, 4 x black / red.....	4188
Claw clip set, 4 x black / red.....	4190
Dolphin clip set, 4 x black / red / yellow / blue.....	4193
DCF antenna module.....	4197
Accessory case, outdoor.....	4185

Operating PCs

Portable operating PC.....	6065
Stationary operating PC.....	11630

EXAMPLES OF APPLICATIONS

EPPE CX

EN 50160 - Analysis of 2 voltage systems

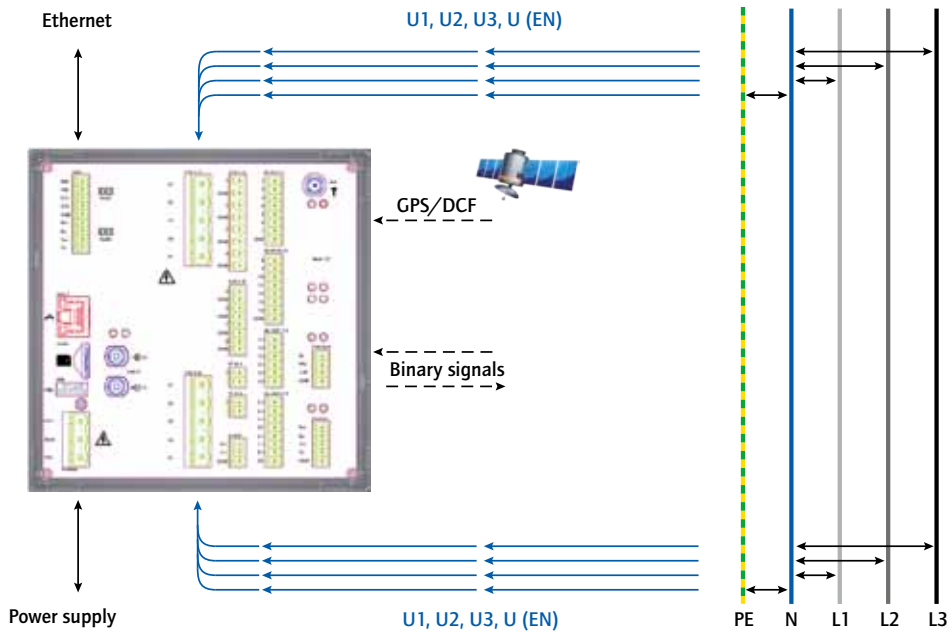

EN 50160 - Analysis of 2 voltage systems with additional current measurement

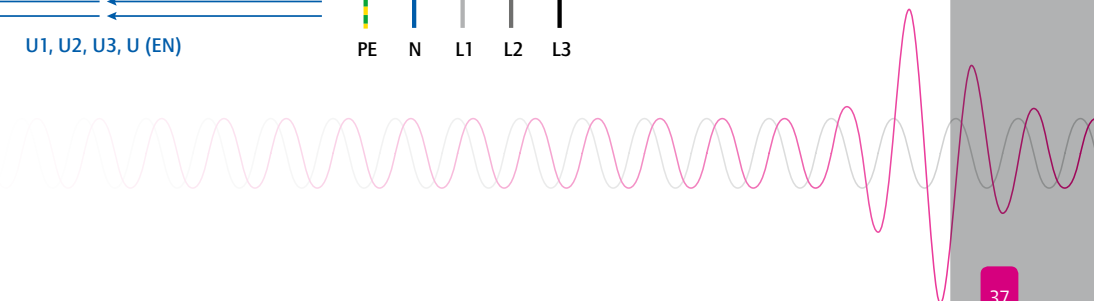
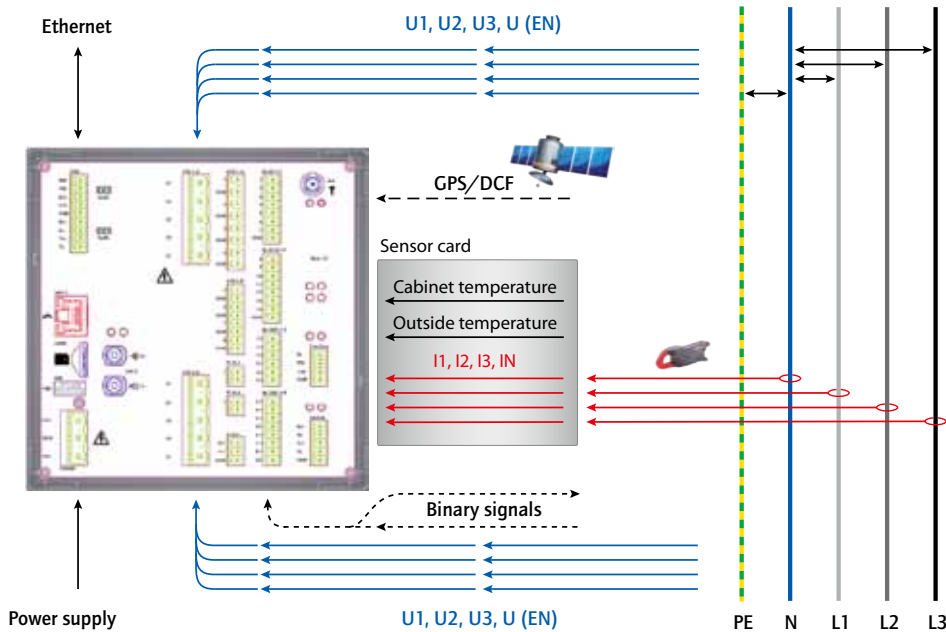

EXAMPLES OF APPLICATIONS

EPPE CX | PX

EN 50160 - Analysis of voltage, current, power (energy)

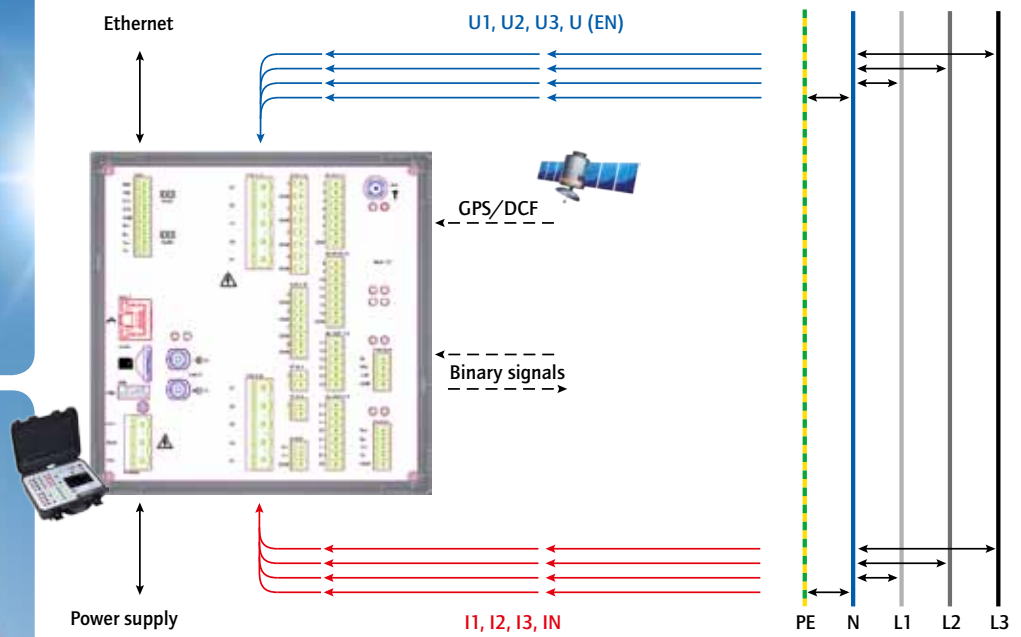

PV plant

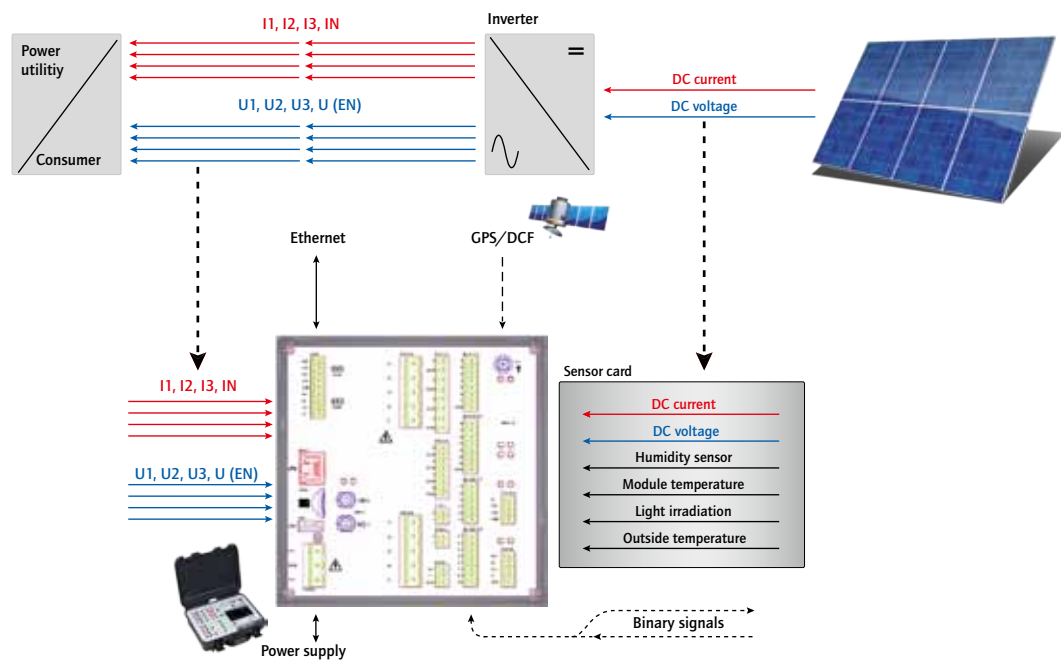

Differential current measurement including voltage analysis

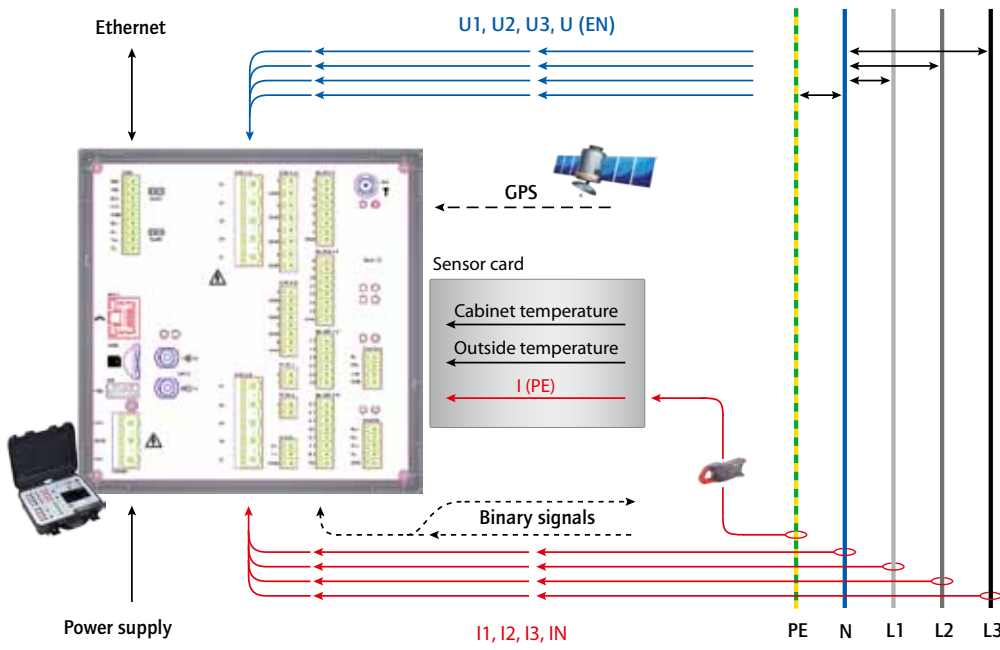

Wind power plant

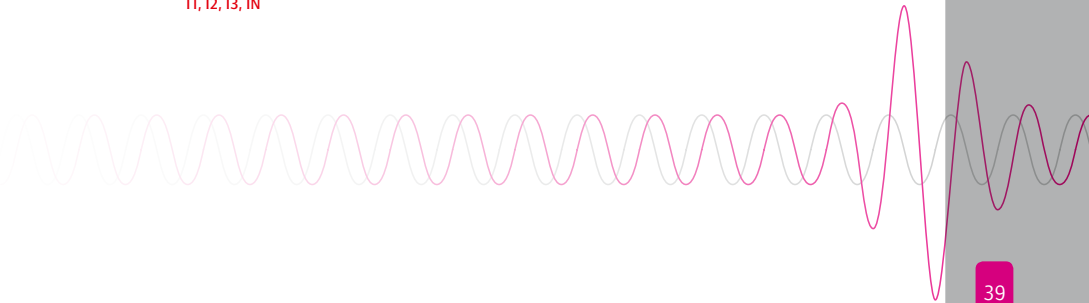
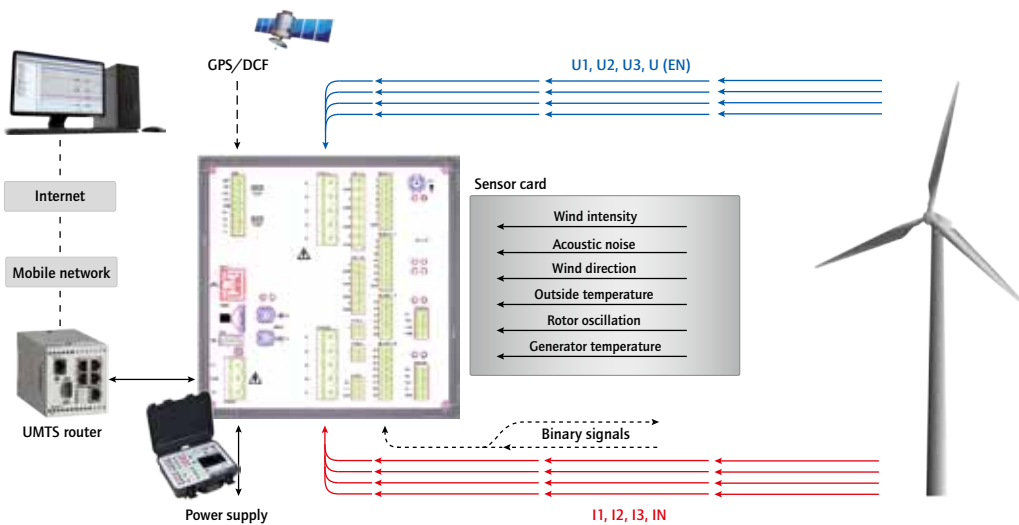

EPPE.

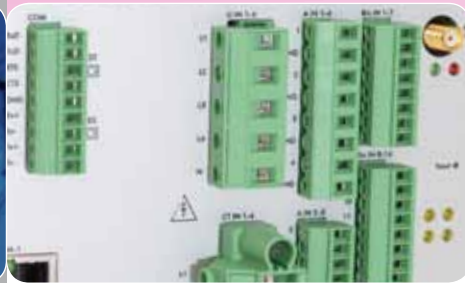

KoCoS Messtechnik AG
Südring 42
34497 Korbach, Germany
Tel. +49 5631 9596-40
Fax +49 5631 9596-17
info@kocos.com
www.kocos.com