

# BK PRECISION®

Model: 2511, 2512, 2515, 2516

## 2510 Series Handheld Digital Storage Oscilloscopes

USER MANUAL



# Safety Summary

The following safety precautions apply to both operating and maintenance personnel and must be observed during all phases of operation, service, and repair of this instrument. Before applying power, follow the installation instructions and become familiar with the operating instructions for this instrument.

If this device is damaged or something is missing, contact the place of purchase immediately.

This manual contains information and warnings that must be followed to ensure safe operation as well as maintain the meter in a safe condition.

## ***DO NOT OPERATE IN AN EXPLOSIVE ATMOSPHERE***

Do not operate the instrument in the presence of flammable gases or fumes. Operation of any electrical instrument in such an environment constitutes a definite safety hazard.

## ***KEEP AWAY FROM LIVE CIRCUITS***

Instrument covers must not be removed by operating personnel. Component replacement and internal adjustments must be made by qualified maintenance personnel. Disconnect the power cord before removing the instrument covers and replacing components. Under certain conditions, even with the power cable removed, dangerous voltages may exist. To avoid injuries, always disconnect power and discharge circuits before touching them.

## ***DO NOT SUBSTITUTE PARTS OR MODIFY THE INSTRUMENT***

Do not install substitute parts or perform any unauthorized modifications to this instrument. Return the instrument to B&K Precision for service and repair to ensure that safety features are maintained.

## ***WARNINGS AND CAUTIONS***

***WARNING*** and ***CAUTION*** statements, such as the following examples, denote a hazard and appear throughout this manual. Follow all instructions contained in these statements.

A ***WARNING*** statement calls attention to an operating procedure, practice, or condition, which, if not followed correctly, could result in injury or death to personnel.

A **CAUTION** statement calls attention to an operating procedure, practice, or condition, which, if not followed correctly, could result in damage to or destruction of part or all of the product.

---

**NOTE:**

**Voltage ratings are given as “working voltage”. They should be read as Vac-rms (50 – 60 Hz) for AC sine wave applications and as Vdc for DC applications.**

---

**WARNING**

- Do not connect the scope probes and DMM leads simultaneously.
- Before using the DMM functions, disconnect all scope probes. Likewise, disconnect all DMM test leads before using any scope functions.
- When not in use, remove all scope probes, DMM test leads, and the USB cable.

**WARNING**

To avoid potential fire or shock hazard:

- Disconnect all probes, leads, power adapter, and USB cable before opening the battery cover.
- Do not turn on the instrument while the battery cover is removed.
- Use only the included insulated probes, test leads, and power adapter supplied with the instrument.
- Use only the battery pack supplied with the instrument or approved by us. Do not use other substitutes.
- For AC power operation, always connect the adapter to the outlet first before connecting to the instrument.
- Observe all markings and ratings on the instrument before connecting to the instrument.
- While making measurements, verify that the performance ratings of instruments and accessories that are used meet the correct safety levels of the instrument.

- Do not insert metal objects into any of the connectors.

### **WARNING**

- Do not use any exposed metal BNC or banana plug connectors with the instrument. Use only the insulated accessories supplied with the instrument.
- Do not connect the USB cable while the instrument is not in use. Keep the cable away from all probes and test leads.
- Always connect the probes or test leads to the instrument first before connecting to any other device under test (DUT). To remove, disconnect them from the DUT first before disconnecting from the instrument.
- Do not operate the instrument in wet environments.
- For high voltage testing, keep the BNC connectors and the entire instrument dry.
- Do not apply input voltages above the instrument and the probe's voltage rating.

### **CAUTION**

- Always cover the DC power input and USB ports on the side of the instrument with the rubber lid when not in used.
- Do not use any abrasive chemicals or volatile liquid when cleaning the instrument. If using a cloth dampened with water, allow the instrument to completely dry before reconnecting it.

## Compliance Statements

Disposal of Old Electrical & Electronic Equipment (Applicable in the European Union and other European countries with separate collection systems)

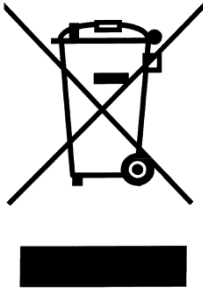

This product is subject to Directive 2002/96/EC of the European Parliament and the Council of the European Union on waste electrical and electronic equipment (WEEE), and in jurisdictions adopting that Directive, is marked as being put on the market after August 13, 2005, and should not be disposed of as unsorted municipal waste. Please utilize your local WEEE collection facilities in the disposition of this product and otherwise observe all applicable requirements.

# CE Declaration of Conformity

The power supply meets the requirements of 2006/95/EC Low Voltage Directive and 2004/108/EC Electromagnetic Compatibility Directive with the following standards.

## Low Voltage Directive

- EN 61010-1: 2010  
Safety requirements for electrical equipment for measurement, control, and laboratory use-Part 1: General requirements
- EN 61010-031: 2002+A1: 2008  
Part 31: Safety requirements for hand-held probe assemblies for electrical measurement and test

## EMC Directive

- EN 61326-1: 2006
- EN 61000-3-2: 2006+A2: 2009
- EN 61000-3-3: 2008

## Safety Symbols



Electrical Shock hazard.



Refer to the operating user manual for warning information to avoid hazard or personal injury and prevent damage to instrument.



This symbol shows that the switch is a power switch located at the front panel. Pressing this button turns on the oscilloscope, and holding it down for a few seconds turns off the oscilloscope.

### **CATI**

#### **Category I overvoltage conditions.**

Measurement instruments whose measurement inputs are not intended to be connected to the mains supply. The voltages in the environment are typically derived from a limited-energy transformer or a battery.

### **CATII**

#### **Category II overvoltage conditions.**

Measurement instruments whose measurement inputs are meant to be connected to the mains supply at a standard wall outlet or similar sources.

### **CATIII**

#### **Category III overvoltage conditions.**

Measurement instruments whose measurement inputs are meant to be connected to the mains installation of a building.



### **Maximum Input Voltages**

#### **Oscilloscope Inputs**

- Maximum input voltage to CH1 and CH2 BNC direct(1:1) - CATII 300V RMS, CATI 150V RMS
- Maximum input voltage to CH1 and CH2 BNC via 10:1 probe PR250SA (included with models 2515 and 2516) - CATII 1000V RMS, CATIII 600V RMS

- Maximum input voltage to CH1 and CH2 BNC via 1X/10X probe PR150SA (included with models 2511 and 2512) – CATII 300V RMS
- Scope Input – CATII 300V RMS
- Meter Input – CATII 600V RMS, CATIII 300V RMS

---

**NOTE:**

**Voltage ratings are given as “working voltage”. They should be read as Vac-rms (50 – 60 Hz) for AC sine wave applications and as Vdc for DC applications.**

---



**Maximum Floating Voltage**

***These apply to models 2515 and 2516 only, which have channel isolation that allows for floating measurements.***

- Maximum floating voltage from input CH1 and CH2 to earth ground – CATII 1000V RMS, CATIII 600V RMS
- Maximum floating voltage between CH1 and CH2 reference – CATII 1000V RMS, CATIII 600V RMS

***The following applies to all models:***

- Maximum floating voltage from multimeter reference to earth ground – CATII 600V RMS, CATIII 300V RMS

---

**NOTE:**

**Voltage ratings are given as “working voltage”. They should be read as Vac-rms (50 – 60 Hz) for AC sine wave applications and as Vdc for DC applications.**

---



## Environmental Conditions

The instrument may be operated in the following environment.

Operating Environment	0 °C to 40 °C
Storage Humidity	0 – 85% R.H.
Storage Environment	-20 °C to +70 °C
Pollution degree	Pollution degree 2
Measurement Category	CAT II, CAT III

## Table of Contents

Safety Summary .....	2
1 General Information .....	16
1.1 Product Overview.....	16
1.2 Package Contents.....	17
1.3 Front Panel Overview.....	18
Front Panel Description .....	18
1.4 Top View.....	20
1.5 Rear Panel Overview .....	20
1.6 Side Panel Overview.....	21
Side Panel Description .....	21
1.7 Display Overview.....	22
Oscilloscope Display.....	22
Digital Multimeter Display .....	24
Recorder/Trend Plot Display.....	25
1.8 Protection Fuse .....	26
1.9 Isolation (Model 2515/2516) .....	26
1.10 Probes.....	27
2 Getting Started.....	28
2.1 Input Power Requirements .....	28
External Power Operation .....	28
Battery Operation .....	29
2.2 Tilt Stand.....	30
2.3 Power On Device .....	30
2.4 Perform Self-Calibration.....	31
2.5 Set to Factory Default .....	32
2.6 Configure Date and Time .....	35
2.7 Probe Compensation.....	36
3 Using the Oscilloscope .....	39

3.1	Channel Selection.....	39
3.2	Channel Menu .....	40
	Channel Coupling .....	41
	Bandwidth Limit .....	41
	Vertical Scale.....	41
	Probe Attenuation Scale .....	41
	Invert Waveform.....	42
	Digital Filter .....	42
3.3	Automatic Settings and Run/Stop Mode .....	43
	Auto Setting .....	43
	Run/Stop Mode.....	44
3.4	Scope Menu.....	44
	Acquire Menu .....	44
	Display Menu .....	45
	Math Menu .....	49
	Horizontal System .....	54
	Vertical System .....	60
	Reference Waveform Menu .....	62
3.5	Trigger System.....	64
	Adjust Trigger Level.....	64
	Edge Trigger .....	65
	Pulse Trigger.....	67
	Video Trigger.....	69
	Slope Trigger .....	72
	Alternative Trigger .....	74
3.6	Connecting External Memory .....	75
3.7	Save/Recall Function .....	76
	Saving and Recalling Setups and Waveforms .....	78
	Saving Screen Capture .....	83
	Saving Waveform Data .....	83

3.8	Utility Menu.....	84
	Check System Information .....	86
	Enable/Disable Key Sound .....	87
	Enable/Disable Frequency Counter .....	87
	Set the Language.....	88
	Updating Firmware .....	88
	Set Screen Saver.....	90
	Waveform Record Function .....	90
	Playback Recorded Waveform.....	93
3.9	Measurement and Cursor Functions.....	94
	Measurement Functions.....	94
	Cursor Functions .....	101
4	Using the Digital Multimeter .....	108
4.1	DC and AC Voltage Measurements .....	109
	DC Voltage Measurement.....	110
	AC Voltage Measurements .....	112
4.2	DC and AC Current Measurements .....	113
	DC Current Measurements .....	114
	Make AC Current Measurements .....	116
4.3	Make Resistance Measurements .....	118
4.4	Make Diode Measurements.....	120
4.5	Continuity Test .....	121
4.6	Make Capacitance Measurements.....	123
4.7	Using Trend Plot .....	124
5	Using the Recorder .....	125
	Scope Trend Plot.....	125
	Record Data with Trend Plot.....	127
	Save Recorded Data to External Memory.....	129
	Scope Recorder .....	130
	Configure Record Options.....	133

	Start Scope Recording.....	133
	Playback Scope Recording .....	134
	Meter Trend Plot.....	136
	Record Data with Trend Plot.....	139
	Save Recorded Data to External Memory.....	140
6	Remote Communication .....	142
7	Troubleshooting Guide .....	143
	System Message Prompts and Instructions.....	143
	Frequency Asked Questions.....	144
	Oscilloscope .....	144
	Multimeter .....	145
8	Specifications .....	146
	Oscilloscope Specifications .....	146
	Maximum Input Voltages.....	150
	Multimeter Specifications.....	152
	Recorder Specifications .....	154
	General Specifications .....	155
11	Maintenance .....	156
	Cleaning.....	156
	SERVICE INFORMATION .....	157
	LIMITED THREE-YEAR WARRANTY .....	158

## List of Figures

Figure 1 - Front Panel View .....	18
Figure 2 - Top View .....	20
Figure 3 - Rear View .....	20
Figure 4 - Side View.....	21
Figure 5 - Oscilloscope Display.....	22
Figure 6 - Multimeter Display .....	24
Figure 7 – Scope Trend Plot Display.....	25
Figure 8 - Connecting Power Adapter.....	28
Figure 9 - Installing Battery.....	29
Figure 10 - Boot Screen.....	31
Figure 11 - Utility Menu 4/4.....	35
Figure 12 - Date/Time Menu.....	35
Figure 13 - Date and Time Display .....	36
Figure 14 - Channel Display.....	39
Figure 15 - Auto Setting .....	43
Figure 16 - XY Mode.....	47
Figure 17 - Inverted Screen Color .....	48
Figure 18 - Grid and Axes Display .....	48
Figure 19 - Axes Only Display.....	49
Figure 20 - No Grid and Axes Display.....	49
Figure 21 - Math Waveform Display .....	51
Figure 22 - FFT Full Screen (left), Split Screen (right) .....	53
Figure 23 - Horizontal Position Reference Marker .....	55
Figure 24 - Horizontal Scale Indicator.....	55
Figure 25 - Horizontal Position Indicator .....	56
Figure 26 - Horizon Menu .....	56
Figure 27 - Delay Scan.....	57
Figure 28 - Normal Memory Depth.....	58
Figure 29 - Long Memory Depth .....	58
Figure 30 - Vertical Position Markers.....	60
Figure 31 - Vertical Position Indicator .....	61
Figure 32 - Fine Control Volts/Div.....	62
Figure 33 - Reference Waveforms Display.....	63
Figure 34 - Trigger Level Display .....	64
Figure 35 - Hold Off Time Indicator .....	67
Figure 36 - Pulse Width Trigger Condition Display .....	69
Figure 37 - USB Drive Detected.....	76

Figure 38 - USB Drive Removed .....	76
Figure 39 - Directory Menu 1/2 .....	79
Figure 40 - Create Directory Name .....	80
Figure 41 - Save Progress .....	81
Figure 42 - Save Successfully.....	81
Figure 43 - Overwrite Warning .....	82
Figure 44 - Subdirectory View.....	83
Figure 45 - System Information Display.....	87
Figure 46 - Frequency Counter Display.....	88
Figure 47 - Record Frame Indicator .....	92
Figure 48 - Recording Finished.....	92
Figure 49 - All Voltage Measurements Display .....	99
Figure 50 - All Time Measurements Display .....	100
Figure 51 - All Delay Measurements Display .....	100
Figure 52 - All Measurements Display .....	100
Figure 53 - Manual Voltage Cursor .....	102
Figure 54 - Manual Time Cursor .....	103
Figure 55 - Track Cursor Display .....	105
Figure 56 - Auto Cursor Measuring Vpp .....	106
Figure 57 - Auto Cursor Measuring Period .....	107
Figure 58 - Multimeter Display .....	108
Figure 59 - Out of Range .....	111
Figure 60 - Connection for DC Voltage Measurement .....	111
Figure 61 - Connection for AC Voltage Measurement.....	113
Figure 62 - Connection for Low DC Current Measurement.....	115
Figure 63 - Connection for Higher DC Current Measurement.....	115
Figure 64 - Connection for Low AC Current Measurement .....	116
Figure 65 - Connection for Higher AC Current Measurement .....	117
Figure 66 - Connection for Resistance Measurement .....	119
Figure 67 - Connection for Diode Measurement.....	121
Figure 68 - Continuity Test.....	121
Figure 69 - Connection for Continuity Test.....	122
Figure 70 - Capacitance Measurement.....	123
Figure 71 - Connection for Capacitance Measurement.....	124
Figure 72 - Scope Recorder External Save Mode.....	133
Figure 73 - Recording Display .....	134
Figure 74 - Playback Scope Recording .....	135
Figure 75 - Meter Trend Plot Display.....	137

# 1 General Information

## 1.1 Product Overview

The B&K Precision 2510 series handheld digital storage oscilloscope combines the functions of a digital storage oscilloscope, digital multimeter, and a recorder into one portable form factor. The oscilloscope's bandwidth is up to 100 MHz with a real time sampling rate of up to 1 GSa/s. With up to 2M points of deep memory, it allows for capturing more details of a signal for analysis. Additionally, the multimeter provides most of the standard measurement functions, which include AC and DC voltage, AC and DC current, resistance, capacitance, diode, and continuity. The recorder function allows users to quickly capture data without the need to connect to a computer.

### Features:

- 5.7" color TFT LCD Display
- Oscilloscope, multimeter, and recorder functionality (trend plot and waveform recorder)
- Fully isolated oscilloscope channels (models 2515 and 2516 only) and isolated multimeter inputs
- 6000-count multimeter
- Multimeter supports voltage, current, resistance, capacitance, diode, and continuity measurements
- Supports scope and multimeter measurement parameters trend plot and scope waveform recorder
- 32 auto measurement functions
- Store/recall 2 groups of reference waveforms, 20 groups of common waveforms, 10 groups of instrument settings
- USB interface for remote communication



## 1.2 Package Contents

Please inspect the instrument mechanically and electrically upon receiving it. Unpack all items from the shipping carton, and check for any obvious signs of physical damage that may have occurred during transportation. Report any damage to the shipping agent immediately. Save the original packing carton for possible future reshipment. Every oscilloscope is shipped with the following contents:

- **1 x 2510 series handheld digital storage oscilloscope**
- **1 x 7.4 V Li-Ion battery (inside battery compartment)**
- **1 x User Manual**
- **2 x 10X CATIII 600 V probes (models 2515 and 2516 only)**
- **2 x 1X/10X CATII 300 V probes (models 2511 and 2512 only)**
- **1 x Pair of DMM test leads**
- **1 x Carrying case and straps (models 2515 and 2516 only)**
- **1 x USB cable**
- **1 x Probe compensation connector**
- **1 x AC power adapter**
- **1 x Certificate of Calibration**

Verify that all items above are included in the shipping container. If anything is missing, please contact B&K Precision.

## 1.3 Front Panel Overview

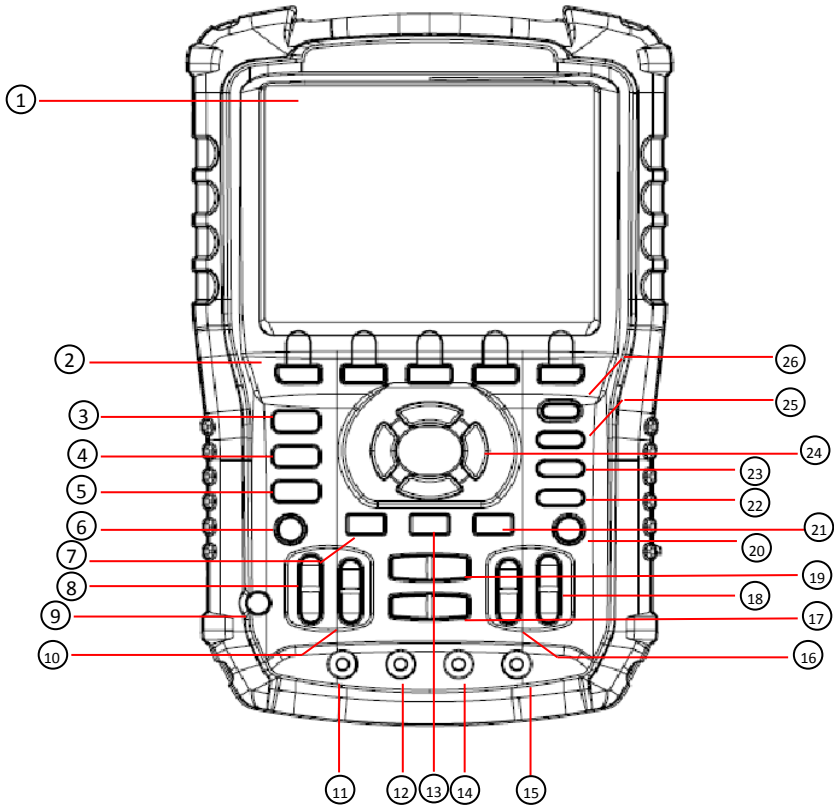
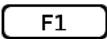
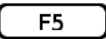







Figure 1 - Front Panel View

### Front Panel Description

①		LCD display
②	 - 	Menu function keys
③		Scope function button
④		Multimeter function button
⑤		Recorder function button <i>Trend plot and waveform recorder</i>
⑥		Channel 1 button (scope)
⑦		Trigger Menu button

8		Channel 1 Volts/div range keys (scope)
9		Power On/Off
10		Channel 1 vertical position keys (scope)
11		10 A current input port (multimeter)
12		mA current input port (multimeter)
13		User/Options Menu
14		COM input port (multimeter)
15		Voltage/Resistance/Capacitance input port (multimeter)
16		Channel 2 vertical position keys (scope)
17		Horizontal position keys (scope)
18		Channel 2 Volts/div range keys (scope)
19		Horizontal Timebase keys (scope)
20		Channel 2 button (scope)
21		Save/Recall Menu button
22		Cursor/Measurement function button (scope)
23		Run/Stop button; also acts as a Single button when trigger mode is set to Single (scope)
24		Arrow selection keys
25		Auto button (scope)
26		Menu On/Off button

## 1.4 Top View

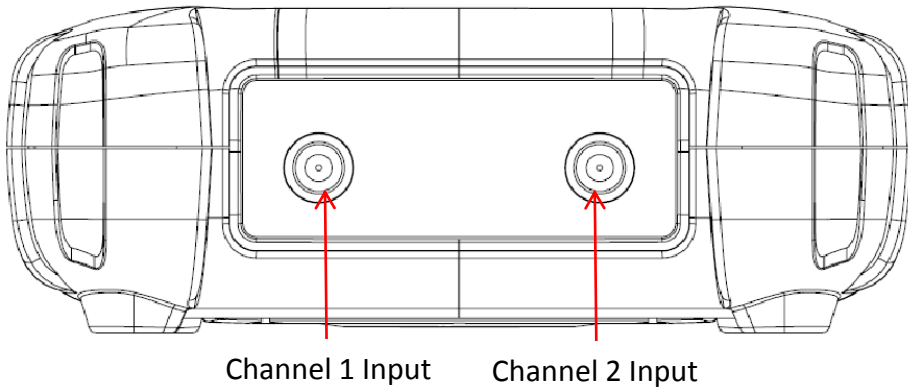

Figure 2 - Top View

## 1.5 Rear Panel Overview

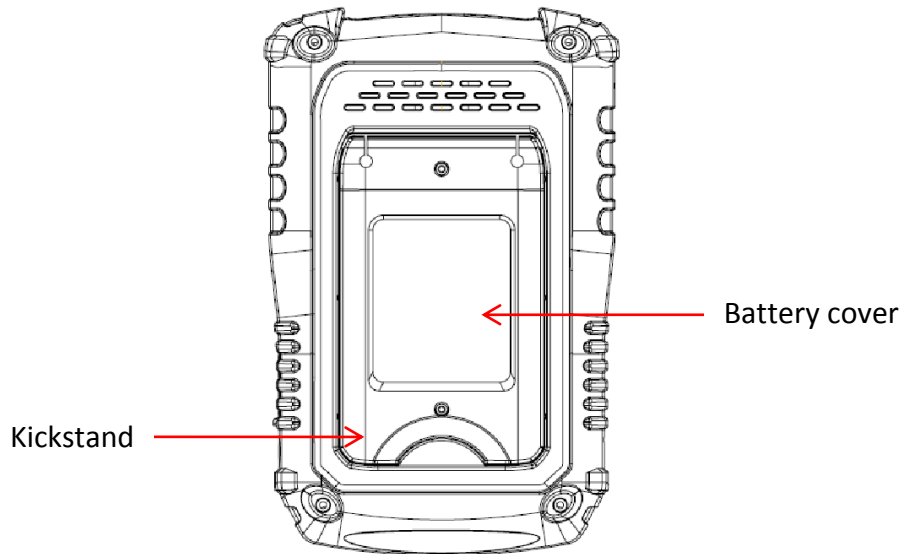

Figure 3 - Rear View

## 1.6 Side Panel Overview

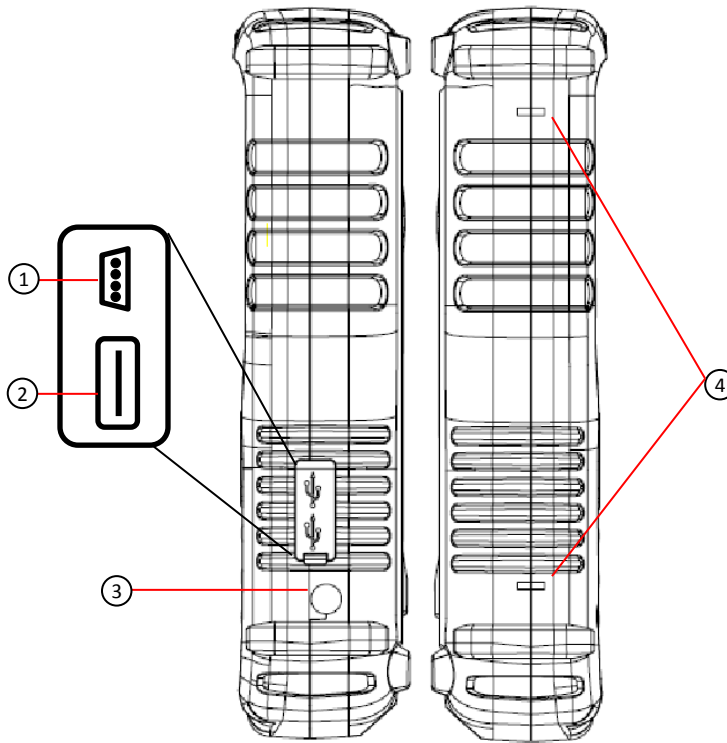

Figure 4 - Side View

### ***Side Panel Description***

- 
- |   |   |
|---|---|
| ① | MiniUSB device port<br><i>For probe compensation and remote interface</i> |
|---|---|
- 
- |   |  |
|---|--|
| ② | USB host port<br><i>For saving/recalling waveforms and instrument setups</i> |
|---|--|
- 
- |   |                              |
|---|------------------------------|
| ③ | External power adapter input |
|---|------------------------------|
- 
- |   |                              |
|---|------------------------------|
| ④ | Mount holes for carry handle |
|---|------------------------------|
-

## 1.7 Display Overview

### Oscilloscope Display

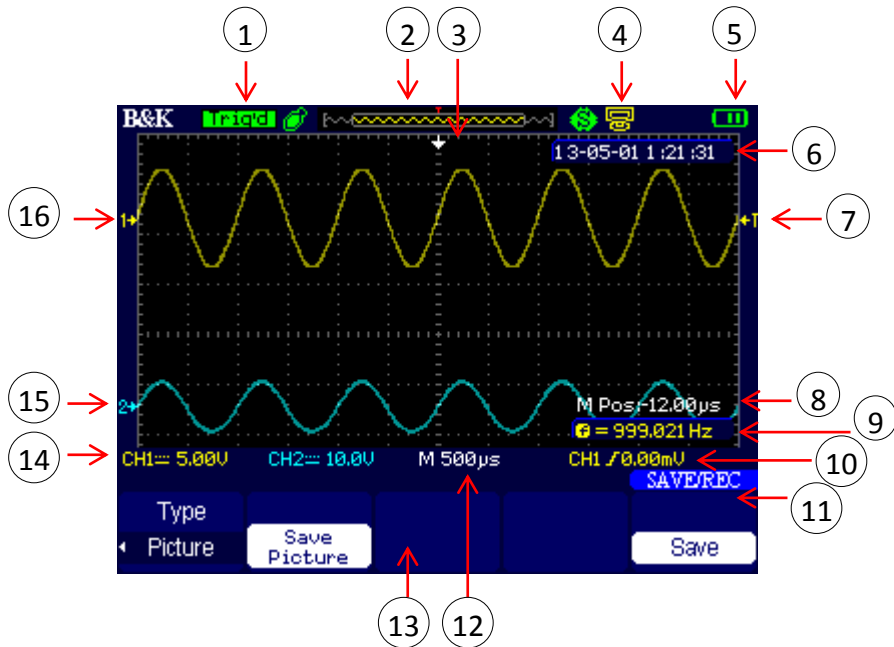

Figure 5 - Oscilloscope Display

---

#### Trigger status

- Armed – Instrument is acquiring pre-trigger data. All triggers are ignored.
  - Ready – All pre-trigger data has been acquired and the instrument is ready to accept a trigger
  - ① • Trig'd – Instrument has triggered and is acquiring post-trigger data
  - Stop – Instrument has stopped acquiring waveform data
  - Auto – Instrument is in auto mode and is acquiring waveforms without trigger
  - Scan – Instrument is acquiring and displaying waveform data continuously. This mode is automatically set for when
-

---

timebase is slow enough in which requires a longer time to “scan” to acquire the entire signal on display

---



② Displays the position of the present waveform window in internal memory

---



③ Horizontal trigger position marker

---

USB mode indicator

- ④
-  Side USB interface is configured for PC communication
  -  Side USB interface is configured for printer (not available)
- 

Battery indicator

- ⑤
-  - Battery charging
  -  - Battery empty
  -  - Battery full
- 

⑥ Time and date display

---

⑦ Trigger position marker

---

⑧ Horizontal trigger position

---

⑨ Trigger signal frequency

---

⑩ Trigger voltage indicator

---

⑪ Menu header/label

---



⑫ Horizontal timebase

---

⑬ Menu display

---

Signal coupling

- ⑭
-  - DC coupling
  -  - AC coupling
  -  - GND(ground) coupling

Volts/div indicator

Bandwidth limit On/Off indicator

-  - Bandwidth limit ON
- 

⑮ Channel 2 identifier

---

⑯ Channel 1 identifier

---

## Digital Multimeter Display

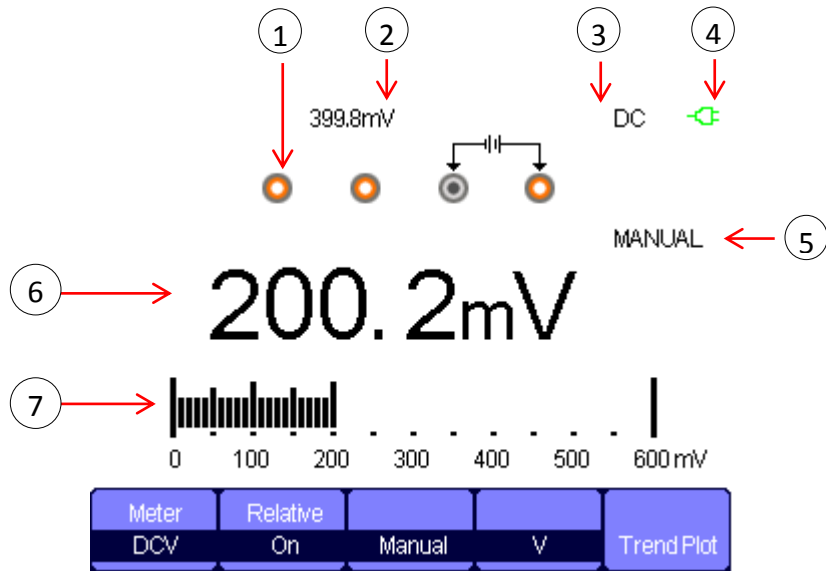

Figure 6 - Multimeter Display

①	Input port indicator <i>Highlights which port to connect to for selected measurement function</i>
②	Relative value display
③	Measurement type
④	AC power indicator
⑤	Operation mode
⑥	Measurement reading display
⑦	Measurement bar graph



## Recorder/Trend Plot Display

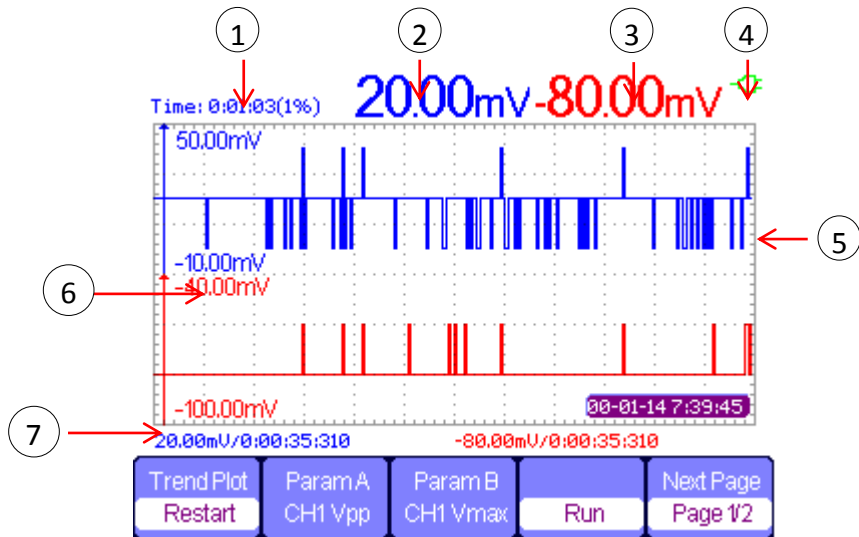

Figure 7 – Scope Trend Plot Display

①	Recording/Trend Plot time
②	Parameter A measured value
③	Parameter B measured value
④	Battery indicator
⑤	Parameter A measured data plot
⑥	Parameter B measured data plot
⑦	Current measured value and time

## 1.8 Protection Fuse

There are two input protection fuses for the current measurement inputs, labeled **mA** and **10 A**.

The **10 A** input is protected with an internal 10 A, 250 V slow blow glass tube type fuse.

The **mA** input is protected with an internal 600 mA PPTC (resettable) type fuse, rated 250 V.

## 1.9 Isolation (Model 2515/2516)

Models 2515 and 2516 have fully isolated channel inputs, which allow for making floating measurements safely and accurately in various applications that may not have reference to earth ground.

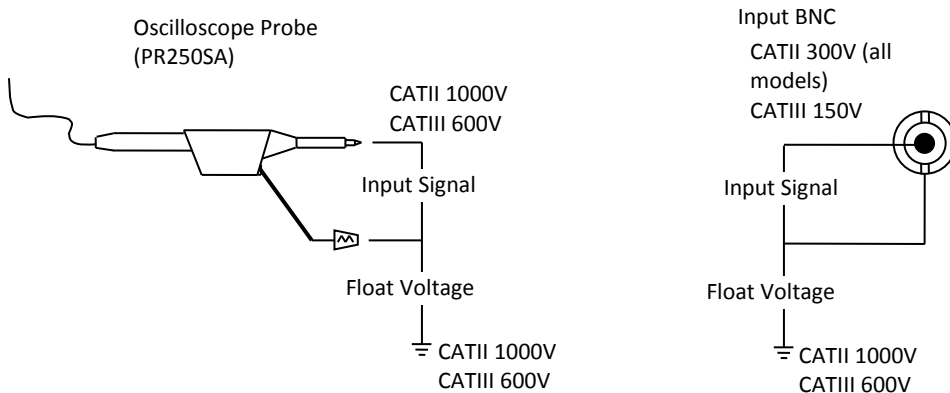

## 1.10 Probes

---

**WARNING:**

**Only use the supplied oscilloscope probes or probes recommended by B&K Precision. Using probes not recommended and/or supplied by B&K Precision may cause a safety hazard, and may also damage the instrument and void its warranty.**

---

Models 2515 and 2516 come with two touch-protected passive 10X test probes (PR250SA) with the following specifications:

Voltage Rating: 1000 V CATII, 600 V CATIII

Attenuation: 10X

Bandwidth: 250 MHz

Meets IEC 61010-031:2008



Models 2511 and 2512 come with two passive 1X/10X probes (PR150SA) with the following specifications:

Voltage Rating: 300 V CATII

Attenuation: 1X/ 10X

Bandwidth: 17/150 MHz

Meets IEC61010-31

## 2 Getting Started

### 2.1 Input Power Requirements

The handheld oscilloscope can be powered by an AC adapter or by battery.

#### *External Power Operation*

To use the external AC adapter to power the instrument:

1. Connect the adapter to the external power input on the side of the instrument first.
2. Then, connect the supplied power cord to the adapter.
3. Connect AC adapter to an electrical outlet.

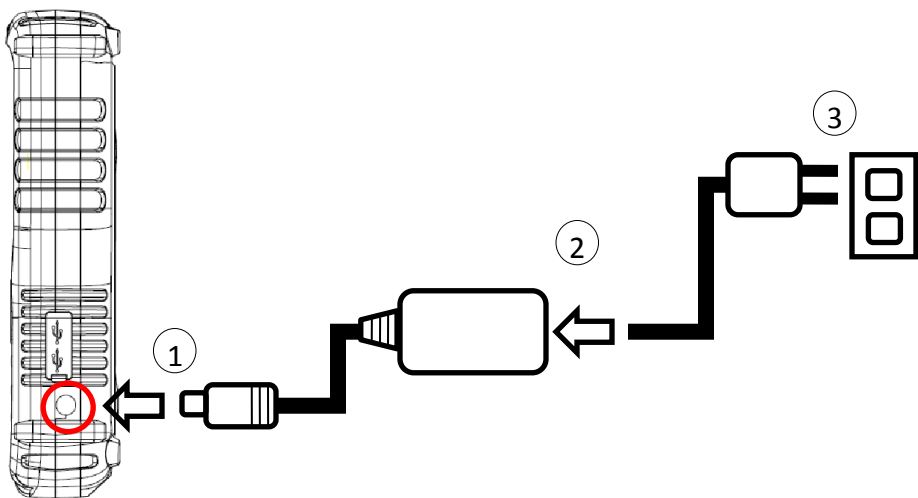

Figure 8 - Connecting Power Adapter

#### **Adapter specifications:**

Input: AC 100-240V, 50/60Hz, 1.2 A

Output: DC 9V, 4 A

⊕ ⊖ Center pin positive, 5.5mm tip

---

**WARNING:**

**Only use the supplied external AC adapter. Using a different or incorrect type adapter will result in damage to the instrument and void its warranty.**

---

### ***Battery Operation***

The instrument can be powered by an external Li-ion battery pack, rated for 5000 mAh, 7.4 V. The battery must be installed and charged before first time use for battery operation.

### ***Installing the Battery***

1. Use a screw driver to remove the two screws securing the battery cover in the rear panel.
2. Connect the 2-pin connector of the battery to the 2-pin input connector on the lower left corner of the battery compartment.
3. Place the battery pack inside the compartment and place the battery cover. Fasten the two screws to tighten.

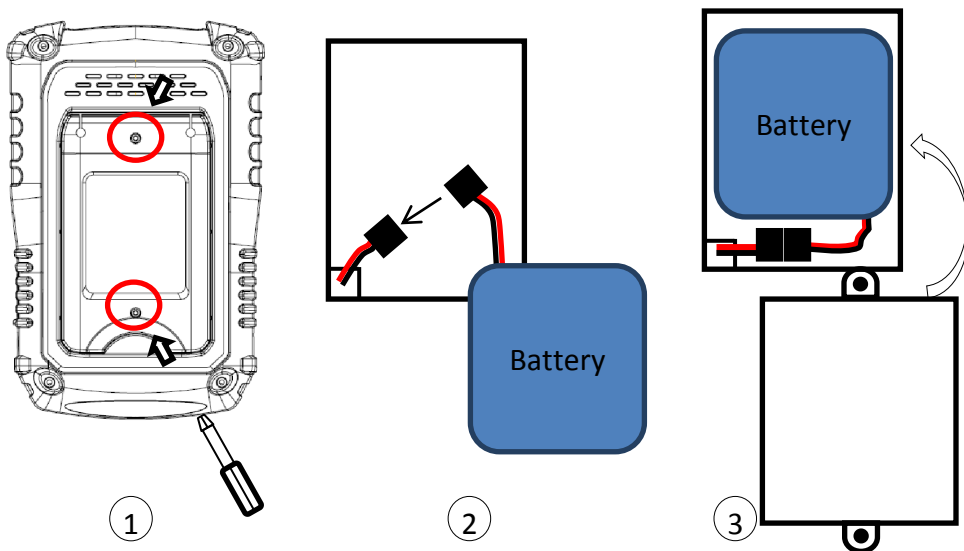

**Figure 9 - Installing Battery**

## ***Charging the Battery***

For first time use, fully charge the battery for at least 4 hours with the instrument turned OFF.

Before charging the battery, follow the instructions above to install the battery. Then, connect the AC adapter to the instrument. While the instrument is ON, the battery indicator will show the battery status for charging and when it's fully charged (see "1.7 Display Overview"). The battery also charges when the instrument is OFF.

## **2.2 Tilt Stand**

The instrument has a tilt stand on the back that can be folded out for benchtop use. Simply pull it out from the back so that the weight of the instrument rests on the stand.



## **2.3 Power On Device**

Power ON the device by pressing  once.

The oscilloscope will display a boot screen shown below for 5-10 seconds before the main operating display appears.



Figure 10 - Boot Screen

To power OFF the device, hold down  for at least 3 seconds.

## 2.4 Perform Self-Calibration

We recommend you to perform self-calibration if any of the following applies:

- Operating temperature changes by more than 5 °C after 30 minutes of use.
- Abnormal behaviors and operations are present.
- Measurements are out of accuracy.

---

### CAUTION:

**Before performing self-calibration, disconnect all inputs of the instrument. Otherwise, the instrument may not calibrate correctly or may cause errors.**

---

To perform self-calibration, follow these steps:

1. Power ON the instrument and allow it to warm up for 30 minutes.
2. Press **User** and press **F1** to select **Do Self Cal**.
3. Follow the prompt on the screen and press **F4** to proceed. To exit and cancel self-calibration, press **F5**.
4. The following screen will display. Wait for the progress bar to show 100% complete. When self-calibration is finished, the screen will prompt you to exit.

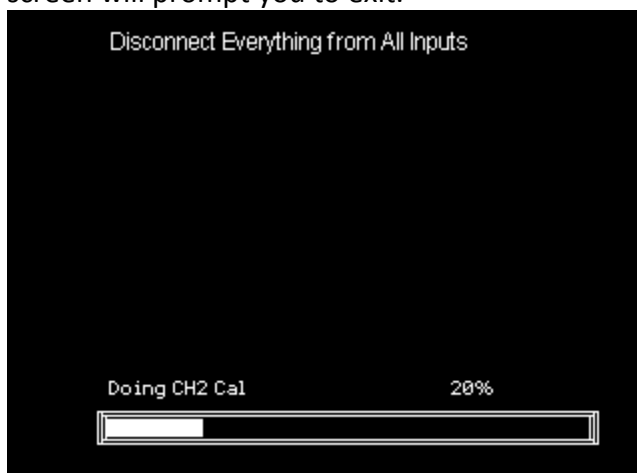

## 2.5 Set to Factory Default

To set the instrument to factory default settings, press **Save Recall** and toggle **F1** to select **Type** and **Factory**. A **Load** option will appear. Press the corresponding **F5** key to load factory default settings.



Table 1 - Factory Default Settings



Menu or system	Options, Knobs or Buttons	Default setup
CH1, CH2	Coupling	DC
	BW Limit	Off
	Volts/div	Coarse
	Probe	1X
	Invert	Off
	Filter	Off
	Volts/div	1.00V
MATH	Operation	CH1+CH2
	CH1 Invert	Off
	CH2 Invert	Off
	FFT Operation:	
	Source	CH1
	Window	Hanning
	FFT Zoom	1X
	Scale	dBVrms
Display	Split	
HORIZONTAL	Window	Main Time Base
	Position	0.00 $\mu$ s
	Sec/div	500 $\mu$ s
	Window Zone	50.0 $\mu$ s
	Trigger knob	Level
CURSOR	Type	Off
	Source	CH1
	Horizontal (voltage)	+/-3.2 divs
	Vertical (time)	+/-5 divs
ACQUIRE	Three Mode Options	Sampling
	Averages	16
	Sampling Method	Real Time
DISPLAY	Type	Vectors
	Persist	off
	Grid	

	Intensity	60%
	Brightness	40%
	Format	YT
	Menu Display	Infinite
SAVE/RECALL	Type	Setups
	Save To	Device
	Setup	No.1
REF	Source	CH1
	REFA	Off
	REFB	Off
UTILITY	Sound	On
	Frequency Counter	On
	USB Device	Computer
	Record	Off
TRIGGER (Edge)	Type	Edge
	Source	CH1
	Slope	Rising
	Mode	Auto
	Coupling	DC
	Level	0.00V
TRIGGER (Pulse)	Type	Pulse
	Source	CH1
	Condition	=
	Set Pulse Width	1.00ms
	Mode	Auto
	Coupling	DC
TRIGGER (Video)	Type	Video
	Source	CH1
	Polarity	Normal
	Sync	All Lines
	Standard	NTSC
	Mode	Auto
TRIGGER (Slope)	Type	Slope
	Source	CH1
	Condition	
	Time	1.00ms

	Mode	Auto
TRIGGER (Alternative)	Type	Alternative
	Source	CH1
	Mode	Edge
	Coupling	DC
	Slope	Rise

## 2.6 Configure Date and Time

Users can configure the date and time on the oscilloscope.

Press **User** and press **F5** three times to go to the **Utility** menu 4.



Figure 11 - Utility Menu 4/4

Press **F3** to select **Date/Time**.

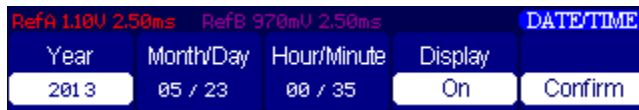





Figure 12 - Date/Time Menu

To configure:

---





Year Press **F1** and use  and  keys to change the year.

---

Month Press **F2** so that the Month is highlighted. Use  and  keys to change the month.

---

Day Press **F2** so that the Day is highlighted. Use  and

	 keys to change the day.
Hour	Press <input type="button" value="F3"/> so that the Hour is highlighted. Use  and  keys to change the hour.
Minute	Press <input type="button" value="F3"/> so that the Minute is highlighted. Use  and  keys to change the hour.

Once set, press  to select **Confirm** option and save changes.

To enable or disable the date and time display, toggle  in the menu to change **Display** to **On** or **Off**. Date and time will be displayed in the upper right corner, as illustrated below.

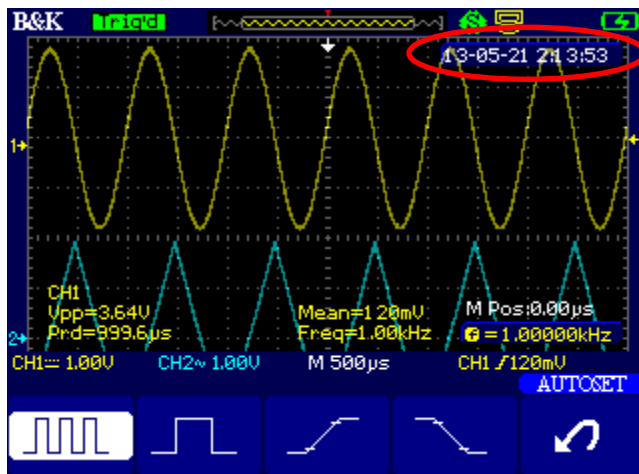

Figure 13 - Date and Time Display

## 2.7 Probe Compensation

When you connect the probe to an arbitrary channel for the first time, please make the following adjustment to make the probe match with the channels. Probes without compensation or compensation warp may lead to

imprecise or false measurements. You can perform the adjustments manually to match your probe with the input channels.

1. Set the probe attenuation option in the channel 1 menu to 10X by pressing **CH1** and press **F4** to select **Probe** until it shows **10X**.
2. Connect the BNC side of the probe to channel 1 input on the top of the instrument.

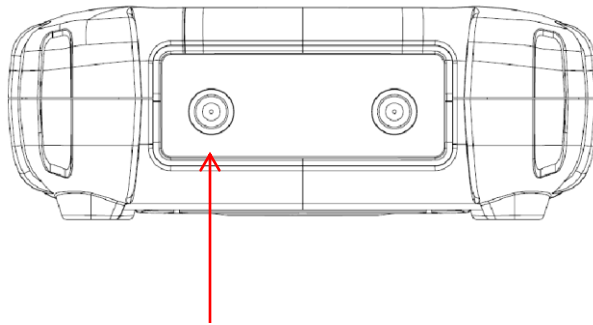

3. Attach the probe compensation connector to the miniUSB port on the side of the instrument.

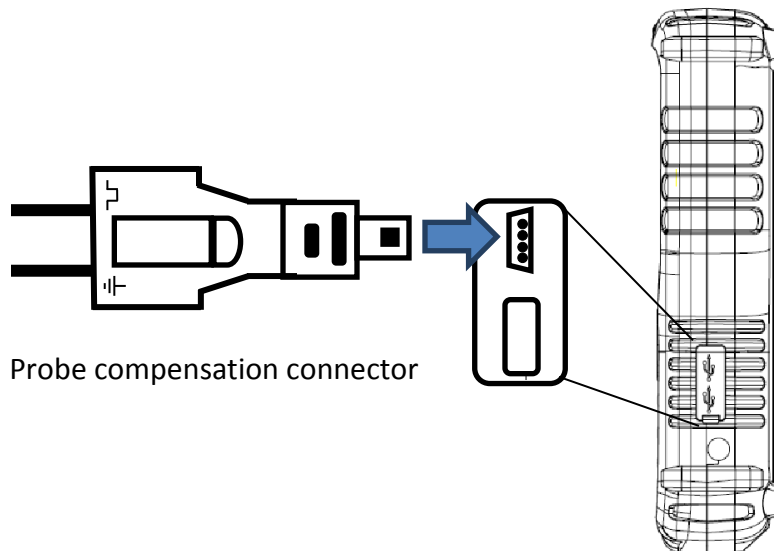

4. Connect the probe tip to the 3V port (1 kHz, 3Vpp Square Wave) and the reference ground clip to the ground port on the probe compensation connector.

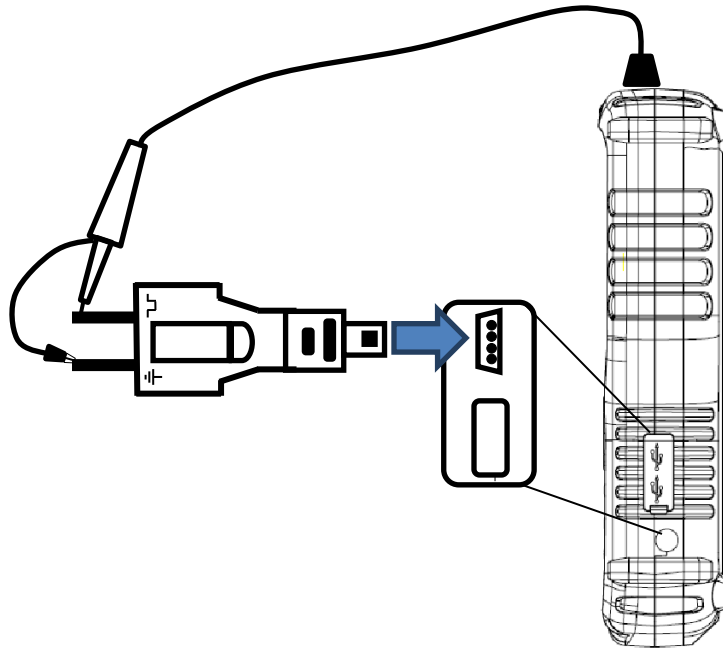

5. Display the channel and press **Auto**.
6. Check the shape of the waveform displaying on the screen.

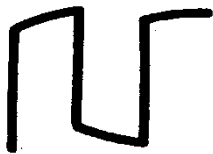

**Under Compensated**



**Correctly Compensated**



**Over Compensated**

7. Adjust the trim on the probe or repeat all the operations above if necessary.

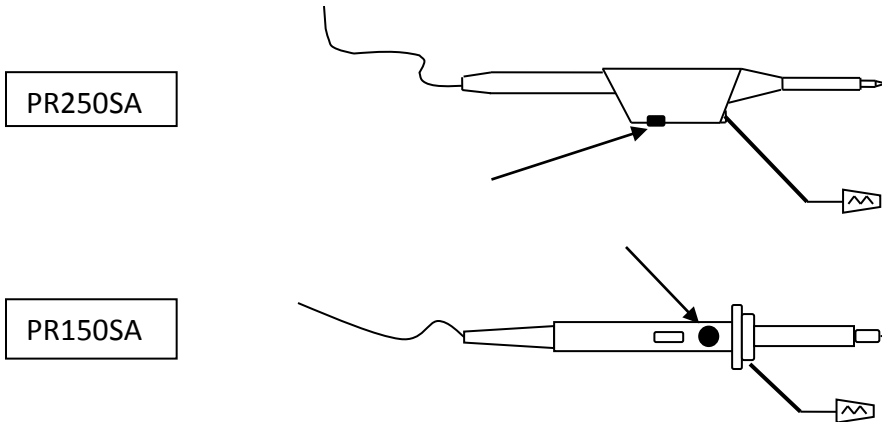

### 3 Using the Oscilloscope

#### 3.1 Channel Selection

Use the **CH1** and/or **CH2** button to enable or disable channel 1 and/or channel 2 on the display. These buttons will also access their respective channel menus.

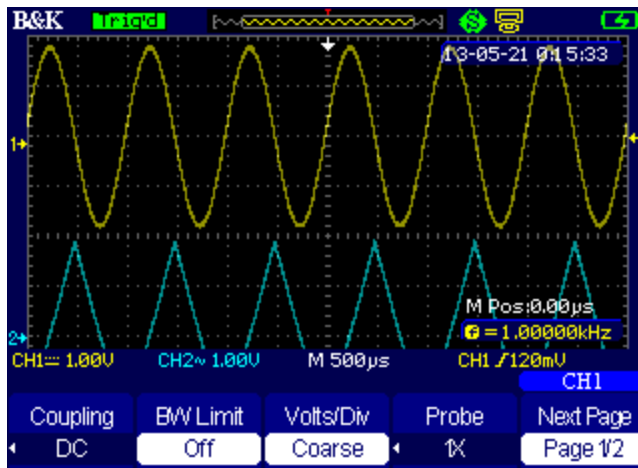

Figure 14 - Channel Display

## 3.2 Channel Menu

To access the channel menu, press **CH1** or **CH2** to display the respective channel menu. Below is a table of the channel menu structure.



Table 2 - Channel Menu 1/2

Menu Option	Setting	Description
<b>Coupling</b>	DC	DC passes both AC and DC components of the input signals.
	AC	AC blocks the DC component of the input signals and attenuates signals below 10 Hz.
	GND	GND disconnects the input signal.
<b>BW Limit</b>	On	Limit the bandwidth above 20 MHz to reduce display noise; filters the signals to reduce noise and other unwanted high frequency components.
	Off	
<b>V/div</b>	Coarse	Change the range of voltage by 1-2-5 sequence.
	Fine	Fine control of the volt/div scale settings.
<b>Probe</b>	1X, 5X, 10X, 50X, 100X, 500X, 1000X	Set to match the type of probe attenuation you are using to ensure correct vertical scale display.
<b>Next Page</b>	Page1/2	Enter the second page of CH1/CH2 menu.





Table 3 - Channel Menu 2/2

Menu Option	Setting	Description
Invert	On Off	Enable/Disable waveform invert function.
Filter		Enter the FILTER menu.
To Zero		Set waveform vertical position and trigger level to zero.
Next Page	Page 2/2	Return to the first page of CH1/CH2 menu.

### ***Channel Coupling***

Both channel 1 and channel 2 coupling can be set to DC, AC, or GND (ground). Press  in the channel menu to toggle the settings.

### ***Bandwidth Limit***

Bandwidth limit can be enabled or disabled by toggling  in the channel menu. When enabled, there will be a **B** indicator next to the channel indicator below the bottom left corner of the oscilloscope waveform display area.

### ***Vertical Scale***

The vertical scale control adjustment can be set for coarse or fine control. Press the  button in the channel menu to toggle between **Coarse** and **Fine**.

### ***Probe Attenuation Scale***

The voltage/division display scale can be changed to match the attenuation factor on the oscilloscope probe. To change this, press the  button

in the channel menu to select and change the **Probe** setting. As you change this setting, the volt/div scale indicator will also change based on the attenuation factor selected.

### ***Invert Waveform***

The oscilloscope can display the inverted signal of the input waveform on channel 1 and channel 2. To enable this, press **F5** from the channel menu to go to the second menu page, and press **F1** to toggle **Invert** between **On** and **Off**.

### ***Digital Filter***

There are four types of digital filters available and can be used to apply to the input waveform. To access the digital filter menu, go to page two of the channel menu and press **F3** to enter the filter menu. Below is a table of the filter menu structure.



**Table 4 - Digital Filter Menu**

<b>Option</b>	<b>Setting</b>	<b>Description</b>
<b>Digital Filter</b>	On	Turn on the digital filter.
	Off	Turn off the digital filter.
<b>Type</b>		Setup as LPF (Low Pass Filter).
		Setup as HPF (High Pass Filter).
		Setup as BPF (Band Pass Filter).
		Setup as BRF (Band Reject Filter).
<b>Upp_Limit</b>		Use the up and down arrow keys to set upper limit.
<b>Low_Limit</b>		Use the up and down arrow keys to set lower limit.
<b>Return</b>		Return to the CH1 or CH2 menu.

## 3.3 Automatic Settings and Run/Stop Mode

### Auto Setting

When measuring an unknown signal, the auto setting function can be used to allow the oscilloscope to automatically adjust the vertical and horizontal scale, range, and trigger to display the signal.

To use this function, input a channel to either or both channel 1 and 2. Then press the **Auto** button. Within a few seconds, the oscilloscope will adjust and display the waveform to fit inside the display window. At this point, press the **MENU** button to select how the waveform should be displayed.

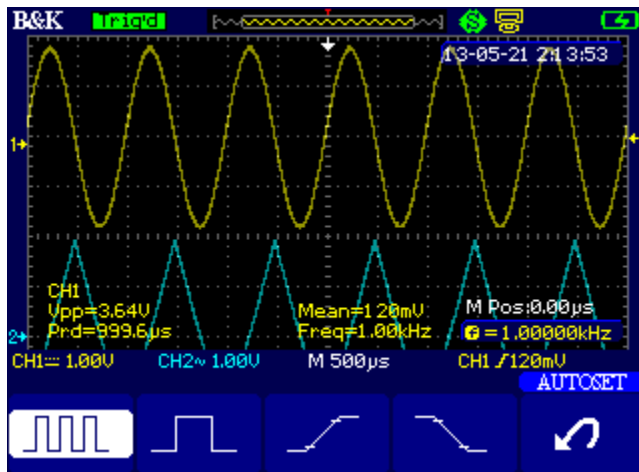

Figure 15 - Auto Setting

- Press **F1** to select the waveform showing multiple cycles.
- Press **F2** to show a single cycle of the waveform if frequency is detected.
- Press **F3** to show the waveform triggered on its rising edge.
- Press **F4** to show the waveform triggered on its falling edge.
- Press **F5** to undo the automatic setting and revert back to the previous settings.

## Run/Stop Mode

Press the **Run/Stop** button to toggle between continuous run mode and stopped mode.

In continuous run mode, the signal going into channel 1 and/or 2 will constantly be triggered regardless of the position of the trigger level. At the top, the indicator will display “Trig’d” to indicate that the signal is triggered.

In stopped mode, the oscilloscope will stop triggering the signals going into channel 1 and/or 2. At this point, users can zoom or pan to view the entire waveform acquired from the last trigger.

## 3.4 Scope Menu

To access the scope menu, press the orange colored **Scope** key. There are five submenus: **Acquire, Display, Math, Horizon, and Ref.**



### Acquire Menu

To access the acquire menu, go to the scope menu and press **F1** to select **Acquire**. Below is a table of the **Acquire** menu structure.



Table 5 - Acquire Menu

Menu Option	Setting	Description
-------------	---------	-------------

<b>Acquisition</b>	Sampling	Sample and display most waveforms accurately.
	Peak Detect	Detect burr and reduce fake wave phenomena.
	Average	Reduce random and irrelative noise.
<b>Averages</b>	4, 16, 32, 64,128,256	Select the number of samples for average acquisition.
<b>Sinx/x</b>	sinx	Use sine interpolation
	x	Use linear interpolation
<b>Mode</b>	Equ time	Set the sampling mode to equivalent sampling.
	Real time	Set the sampling mode to real time sampling.
<b>Sa Rate</b>		Display the sampling rate.

To change the settings to any of the menu options, press their corresponding function keys (  -  ).

**Sampling:** To construct the waveform, the scope samples the signals in equal interval.

**Peak Detect:** The scope captures the maximum and minimum values of the signals in every interval to display the waveform.

**Average:** The scope acquires several waveforms, averages them, and displays the final waveform. The more average times the smoother the waveform.

**Equivalent Time Sampling:** This mode is good for observing repetitive periodic waveforms. The sampling rate is up to 50 GSa/s.

**Real Time Sampling:** The scope will use the highest real-time sampling rate up to the specified maximum sampling rate.

**Note:** Sampling rate varies based on the selected horizontal timebase setting.

### ***Display Menu***

To access the display menu, go to the scope menu and press  to select **Display**. Below is a table of the **Display** menu structure.





Table 6 - Display Menu 1/2

Menu Option	Setting	Description
Type	Vectors	Vectors fill the space between adjacent sample points on the display.
	Dots	Dots display the sample points only.
Persist	Off 1 sec 2 sec 5 sec Infinite	Set the length of time each displayed sample point remains displayed.
Intensity	0 – 100%	Set waveform intensity.
Brightness	0 – 100%	Set grid brightness.
Next Page	Page 1/2	Enter the second page of DISPLAY menu.





Table 7 - Display Menu 2/2

Menu Option	Setting	Description
Format	YT	YT format displays the vertical voltage in relation to time (horizontal scale).
	XY	XY format displays a dot each time a sample is acquired on channel 1 and channel 2.
Screen	Normal	Set to normal mode.
	Inverted	Set to invert color display mode.
Grid		Display grids and axes on the screen.
		Turn off the grids.
		Turn off the grids and axes.

<b>Menu Display</b>	2sec, 5sec, 10sec, 20sec, Infinite	Set display time of menu on the screen.
<b>Next Page</b>	Page 2/2	Return to the first page of DISPLAY menu.

To change the settings to any of the menu options, press their corresponding function keys (  -  ).

**Persistence:** The waveform persistence can be configured by changing the **Persist** menu option of the **Display** menu page 1. Use the  to toggle between persistence timing.

**Intensity and Brightness:** The waveform intensity and the display grid brightness can be adjusted by first pressing  for intensity or  for grid brightness in the **Display** menu page 1. Then, use the  or  arrow keys to increase or decrease the intensity or brightness percentage respectively.

**YT format:** YT is the default format that displays the waveform of voltage vs. time.

**XY format:** XY is the format that display the waveform as channel 1 (X) vs. channel 2 (Y). When this format is used, the horizontal scale and position keys cannot be used.

Below is an example of using XY mode with two sine waves for channel 1 and 2 with 90 degree offset.

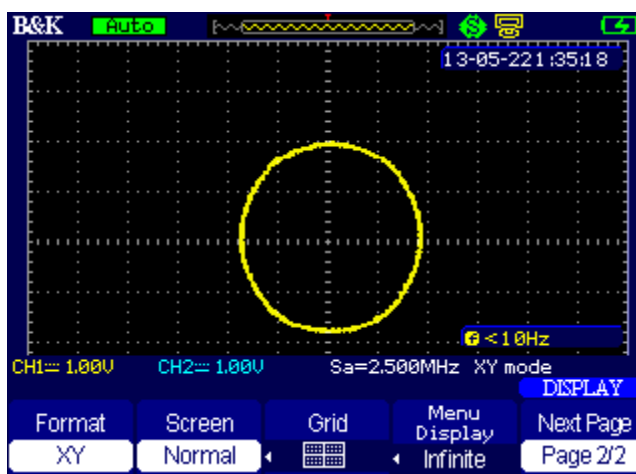

Figure 16 - XY Mode

**Screen Invert:** The colors of the screen can be inverted. Toggle the **F2** button in the **Display** menu 2 to switch between normal and inverted display. Below is an illustration of the inverted screen.

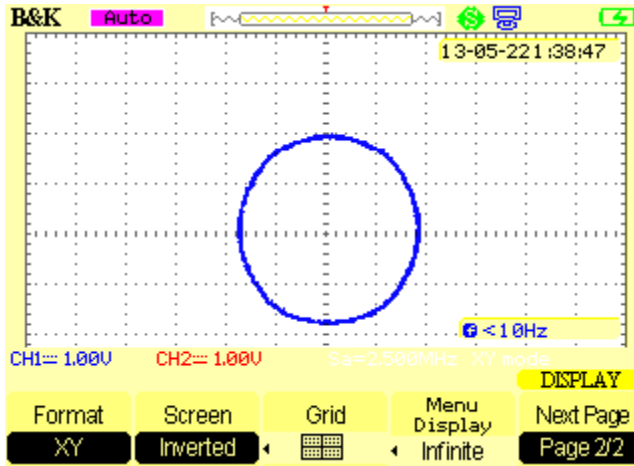

Figure 17 - Inverted Screen Color

**Grid Display:** The display of the grid can be changed to show grid and axes, axes only, or no grid or axes. The below screenshots illustrate the options. This can be changed by toggling **F3** in the **Display** menu 2.

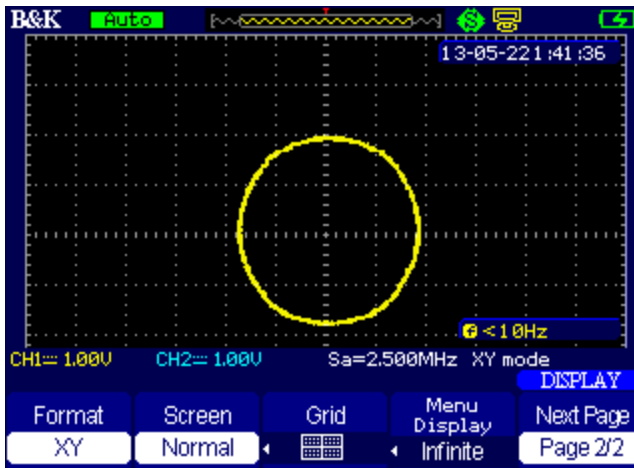

Figure 18 - Grid and Axes Display



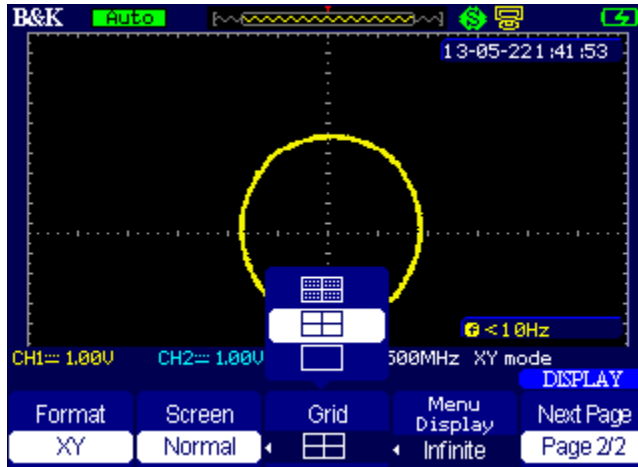

Figure 19 - Axes Only Display

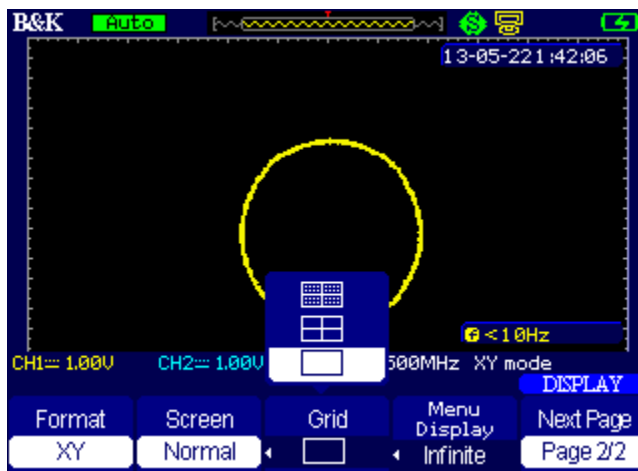

Figure 20 - No Grid and Axes Display

## Math Menu

To access the math menu, go to the scope menu and press F3 to select **Math**. Below is a table of the **Math** menu structure.

**Note:** Math function is not available in XY mode.



Table 8 - Math Menu 1/2

Menu Option	Setting	Description
Operation	+	CH1+CH2
	—	CH1-CH2, CH2-CH1
	*	CH1*CH2
	/	CH1/CH2, CH2/CH1
	FFT	Fast Fourier Transform.
Invert	On	Invert the waveform.
	Off	Disable inverting the waveform.
Next Page	Page1/2	Enter the second page of MATH menu.



Table 9 - Math Menu 2/2

Menu Option	Setting	Description
		Use arrow keys to move the vertical position of the math waveform.
		Use arrow keys to adjust the vertical scale of the math waveform.
	On	Enable math waveform display.
	Off	Disable math waveform display.
Next page	Page2/2	Return to the first menu off math waveform.

**Math operations:** The oscilloscope can perform math operations between channel 1 and channel 2 and display the results as a separate waveform. It supports addition, subtraction, multiplication, and division. When **Math** menu is selected, the display will automatically display a math waveform, such as the screenshot below:

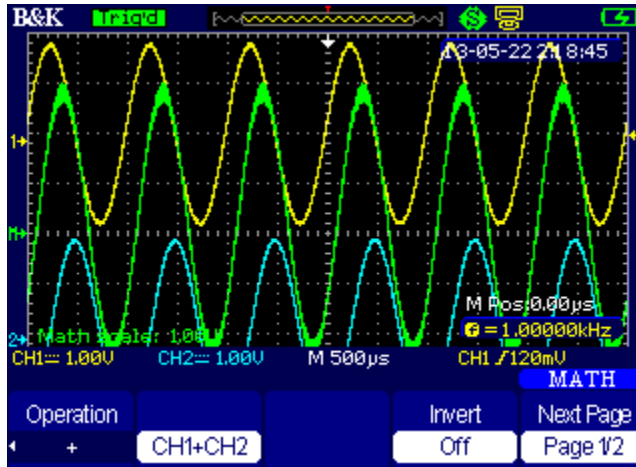

Figure 21 - Math Waveform Display

## FFT

**FFT:** Fast Fourier Transform function is supported. Toggle the F1 button from the **Math** menu 1 to change **Operation** to **FFT** to select this function.

When **FFT** is selected, additional menu options are available. See table below for the **FFT** menu structure.



Table 10 - FFT Menu 1/2

Menu Option	Setting	Description
Operation	+	CH1+CH2
	-	CH1-CH2, CH2-CH1
	*	CH1*CH2
	/	CH1/CH2, CH2/CH1
	FFT	Fast Fourier Transform.
Source	CH1	Selects channel 1 as FFT source.
	CH2	Selects channel 2 as FFT source.

<b>Window</b>	(see table below)	Selects FFT windowing.
<b>FFT Zoom</b>	1X, 2X, 5X, 10X	Zoom function of FFT waveform.

**Table 11 - FFT Window Options**

<b>Window</b>	<b>Characteristic</b>	<b>Best Use Cases</b>
<b>Rectangular</b>	The best frequency resolution but the worst magnitude resolution. It is essentially the same as having no window.	Symmetric transients or bursts. Equal-amplitude sine waves with fixed frequencies. Broadband random noise with a relatively slowly varying spectrum.
<b>Hanning</b>	Better frequency, poorer magnitude accuracy than rectangular window	Sine, periodic, and narrow-band random noise.
<b>Hamming</b>	Hamming has a slightly better frequency resolution than Hanning.	Transients or bursts pulse. The ranges of the signals have great difference from before to after.
<b>Blackman</b>	Best magnitude resolution but worst frequency resolution.	Single frequency waveforms, to find higher order harmonics.

				<b>MATH</b>
Scale	Display			Next Page
dBVrms	Split	ToZero	On	Page 2/2

**Table 12 - FFT Menu 2/2**

<b>Menu Option</b>	<b>Setting</b>	<b>Description</b>
<b>Scale</b>	dBVrms	Set unit scale to dBVrms
	Vrms	Set unit scale to Vrms
<b>Display</b>	CH1	Selects channel 1 as FFT source.
	CH2	Selects channel 2 as FFT source.
	ToZero	Selects FFT windowing.

	On Off	Turn On/Off the FFT waveform.
--	-----------	-------------------------------

When using the FFT function, first select the channel source by toggling the **F2** button from the **FFT** menu 1 to change **Source** between **CH1** and **CH2**.

Use the **F3** button from the **FFT** menu 1 to select the **Window** to use. Descriptions of each window are provided in Table 11 - FFT Window Options above.

Use the **F4** button in the **FFT** menu 1 to adjust the **FFT Zoom**. You can also use the horizontal timebase keys **s** | **ns** to change the **FFT Zoom**.

The FFT waveform can be displayed as part of the full screen or as a split screen from channel 1 and/or 2. Below illustrates the differences.

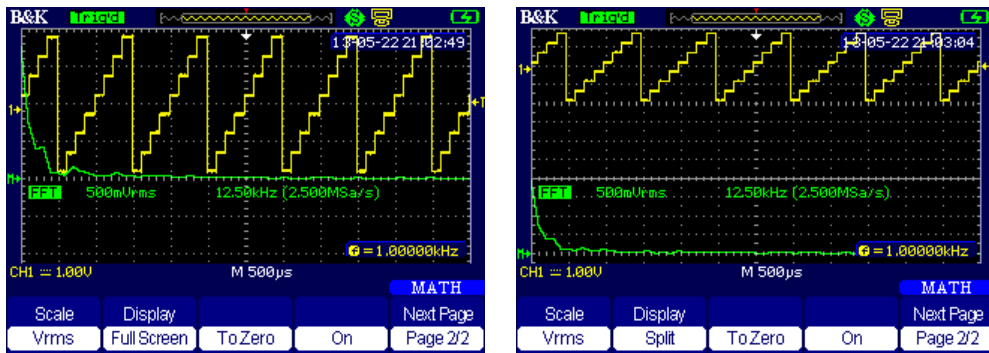
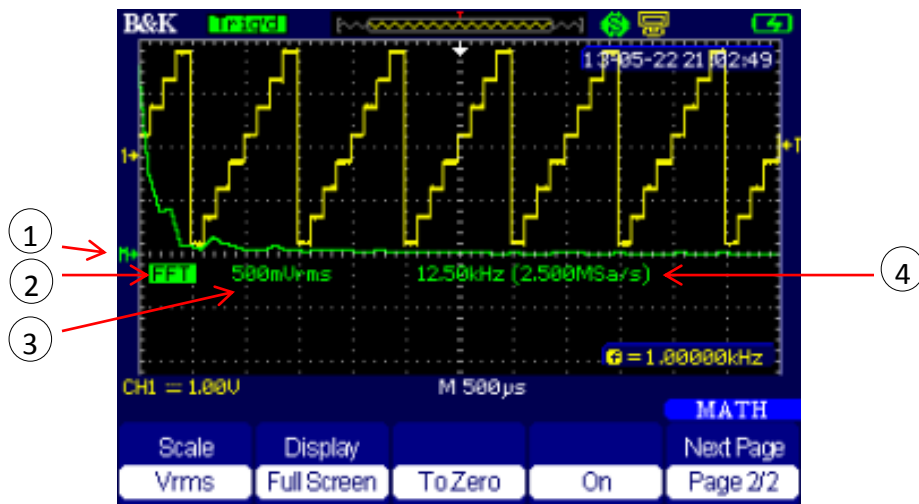

Figure 22 - FFT Full Screen (left), Split Screen (right)

The vertical position of the FFT waveform can be adjusted using channel 1 vertical position keys (if **Source** is **CH1**) **▲** | **▼** or channel 2 vertical position keys (if **Source** is **CH2**) **▲** | **▼**. The position can always be set back to 0 by going into **FFT** menu 2 and pressing **F3** to select **ToZero**.



### ***FFT Display Description***

- 
- ① FFT waveform position
- 
- ② FFT waveform indicator
- 
- ③ FFT vertical scale
- 
- ④ FFT frequency scale and sampling rate
- 

### ***Horizontal System***

#### ***Adjust Horizontal Position***

The horizontal position, or time reference position, marks the reference of the trigger point. The position is indicated by the arrow at the top of the display as marked in the illustration below.

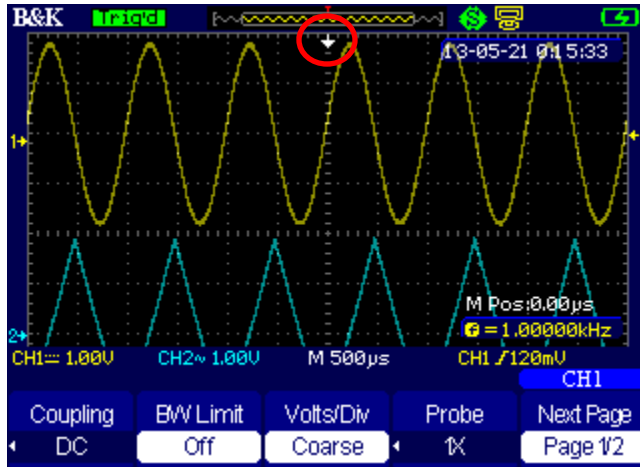



Figure 23 - Horizontal Position Reference Marker

This position can be adjusted by using the  keys to move left (<) or right (>). If the left or right position key is pressed down for > 3 seconds, the position change will be coarse. The scale factor is indicated as marked by the illustration below.

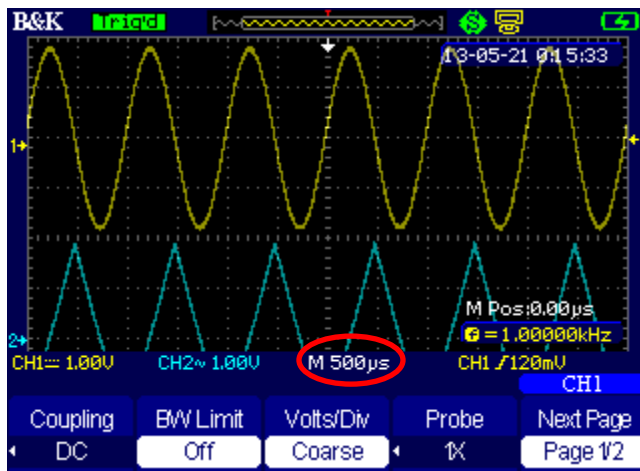

Figure 24 - Horizontal Scale Indicator

The position with center reference to 0 will be displayed as you change the position, as illustrated below:

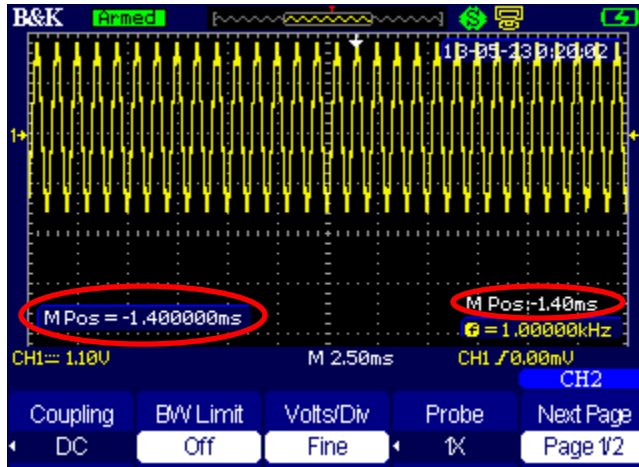
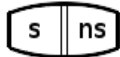

Figure 25 - Horizontal Position Indicator

### *Adjust Horizontal Scale/Timebase*

The horizontal scale or timebase scale factor can be changed using the



keys. Press **s** to adjust to a slower scale, and press **ns** to adjust to a faster scale.

### *Delay Scan*

The instrument has a delay scan function that can be enabled to zoom in on a portion of the channel 1 and/or channel 2 waveforms.

To enable this, press **Scope** and press **F4** to select **Horizon** menu.



Figure 26 - Horizon Menu

Press **F1** to toggle **ON** the **Delayed** option. When delay scan is enabled, the display will change to split screen.



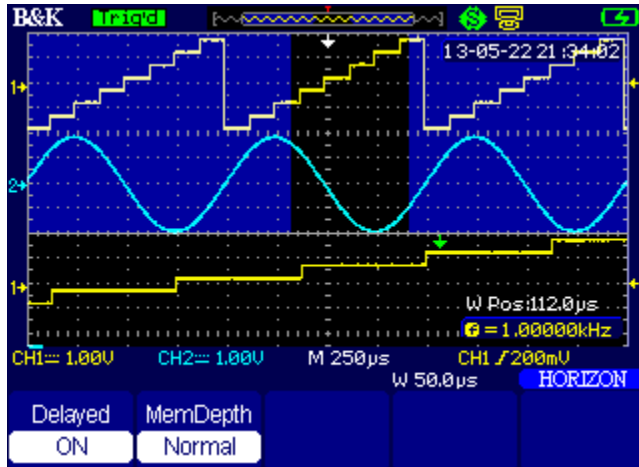

Figure 27 - Delay Scan

The blue shaded areas mark the masked out area and the area in between the blue shaded area is the zoomed portion, shown at the bottom in the split screen.

### *Deep Memory*

The instrument's deep memory function enable storage of a greater number of sampling points for timebase settings between 50 ms to 25  $\mu$ s.

To enable this function, go to the **Horizon** menu and press . Toggle between **Normal** and **Long Mem** (deep memory) for **MemDepth** (memory depth) menu option. The number of sampling points can be computed as follows:

$$\text{Sampling points} = \text{Sampling rate} \times \text{Sampling time}$$

Verify the deep memory function by following these steps:

1. Input a sine wave with 1 kHz, 4 Vpp on either channel 1 or channel 2.
2. Select a timebase between 50 ms to 25  $\mu$ s. In this example, set to 100  $\mu$ s.
3. Set **MemDepth** to **Normal** from the **Horizon** menu. Then press , select **Acquire** menu and note the **Sa Rate** to be **12.50MSa**.

4. Now, go back to **Horizon** menu and change **MemDepth** to **Long Mem**. Go back to **Acquire** menu afterwards and note the **Sa Rate** is now **100.0MSa**.
5. The differences can be visually observed by pressing **(Run/Stop)** to stop the waveform at 100  $\mu$ s. Then adjust the horizontal scale factor to a slower timebase until the entire waveform captured can be shown on the display.
6. Observe with both **MemDepth** set to **Normal** and **Long Mem**.
7. Below is an example between the two captured at 100  $\mu$ s timebase.

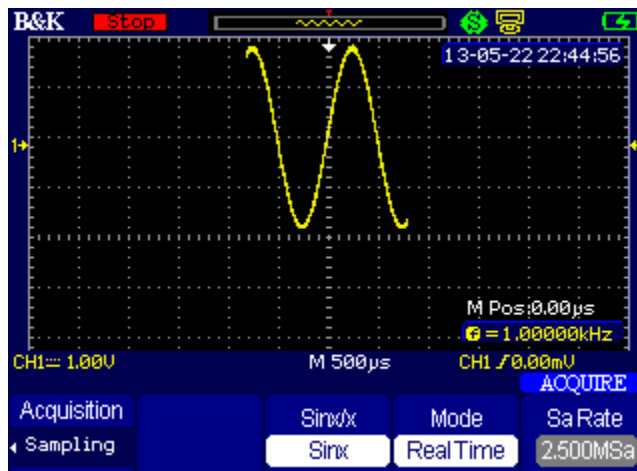

Figure 28 - Normal Memory Depth

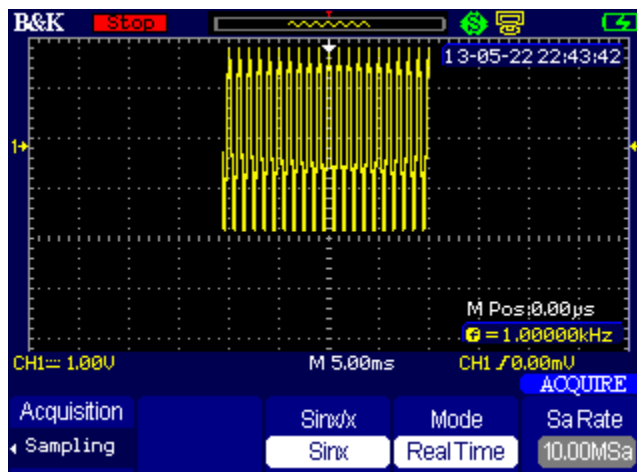

Figure 29 - Long Memory Depth

**Note: Different timebase settings will result in different sampling rates, both with normal and long memory depth configured in MemDepth. Selecting a timebase lower than 50 ms will automatically set the instrument into scan mode. Deep memory is not supported in scan mode. For timebase selections faster than 25  $\mu$ s, the deep memory function will have an adverse affect and will result in fewer sample points than if deep memory is disabled.**

Below is a table describing the different sampling rates for different horizontal timebase settings with and without deep memory enabled.

**Table 13 - Sampling Rate Table**

Timebase	Single channel		Interleaved	
	Normal Sampling Rate	Deep Memory Sampling Rate	Normal Sampling Rate	Deep Memory Sampling Rate
50 s	50 Sa/s	-	50 Sa/s	-
25 s	100 Sa/s	-	100 Sa/s	-
10 s	250 Sa/s	-	250 Sa/s	-
5 s	500 Sa/s	-	500 Sa/s	-
2.5 s	1 kSa/s	-	1 kSa/s	-
1 s	2.5 kSa/s	-	2.5 kSa/s	-
500 ms	5 kSa/s	-	5 kSa/s	-
250 ms	10 kSa/s	-	10 kSa/s	-
100 ms	25 kSa/s	-	25 kSa/s	-
50 ms	25 kSa/s	1 MSa/s	25 kSa/s	1 MSa/s
25 ms	50 kSa/s	2.5 MSa/s	50 kSa/s	2.5 MSa/s
10 ms	125 kSa/s	5 MSa/s	125 kSa/s	5 MSa/s
5 ms	250 kSa/s	10 MSa/s	250 kSa/s	10 MSa/s
2.5 ms	500 kSa/s	25 MSa/s	500 kSa/s	25 MSa/s
1 ms	1.25 MSa/s	50 MSa/s	1.25 MSa/s	50 MSa/s
500 $\mu$ s	2.5 MSa/s	100 MSa/s	2.5 MSa/s	100 MSa/s
250 $\mu$ s	5 MSa/s		5 MSa/s	
100 $\mu$ s	12.5 MSa/s		12.5 MSa/s	
50 $\mu$ s	25 MSa/s		25 MSa/s	
25 $\mu$ s	50 MSa/s		50 MSa/s	
10 $\mu$ s	100 MSa/s		100 MSa/s	

5 $\mu$ s				
2.5 $\mu$ s				
1 $\mu$ s	250 MSa/s	250 MSa/s	250 MSa/s	250 MSa/s
500 ns			500 MSa/s	
250 ns	1 GSa/s	500 MSa/s		
100 ns			500 MSa/s	
50 ns	1 GSa/s	500 MSa/s		
25 ns			500 MSa/s	
10 ns	1 GSa/s	500 MSa/s		
5 ns			500 MSa/s	
2.5 ns (100 MHz models)	1 GSa/s	500 MSa/s		

## Vertical System

### Adjust Vertical Position

The vertical position of channel 1 and channel 2 are marked on the left side of the display, as illustrated below:

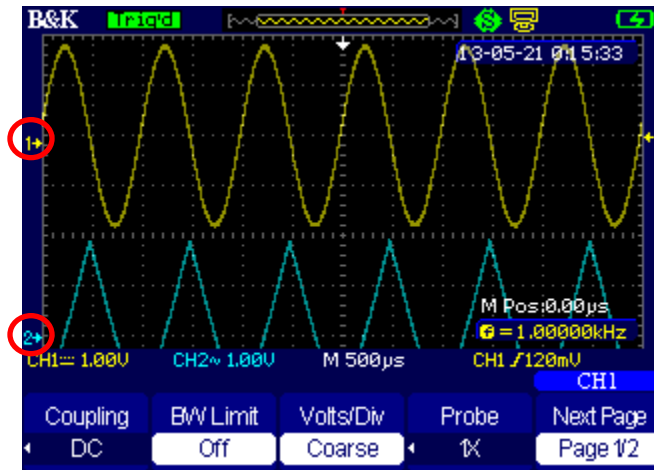

Figure 30 - Vertical Position Markers

To move the vertical position up or down, use the left vertical position keys



(for CH1) or right vertical position keys (for CH2). If the up or down key is pressed down for > 3 seconds, the position change will be coarse. The vertical position relative to center 0 reference will be indicated when changed, as illustrated below:

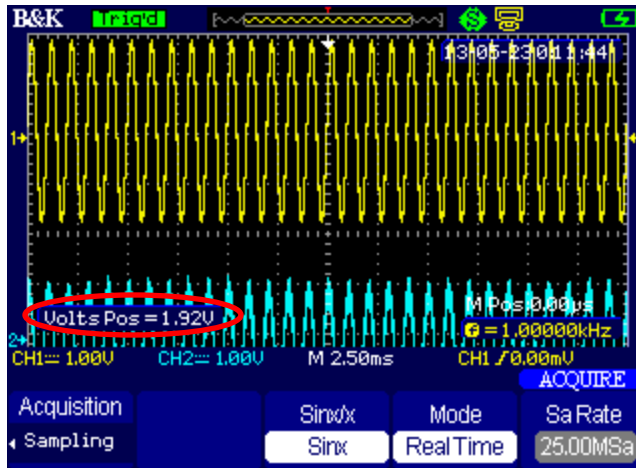
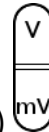

Figure 31 - Vertical Position Indicator

### *Adjust Vertical Scale*

The vertical scale factor can be adjusted by pressing the left volts/div range



keys (for CH1) or the right volts/div range keys (for CH2). To increase the scale, press **V**. To decrease, press **mV**.

By default, the volts/div range keys will change the vertical scale factor in 1-2-5 increments. Users can select fine control so that the change will be finer in increments of 10 mV per key press. To do this, press either **CH1** or **CH2** and press **F3** in the **channel** menu to select **Fine** for **Volts/Div** menu option.

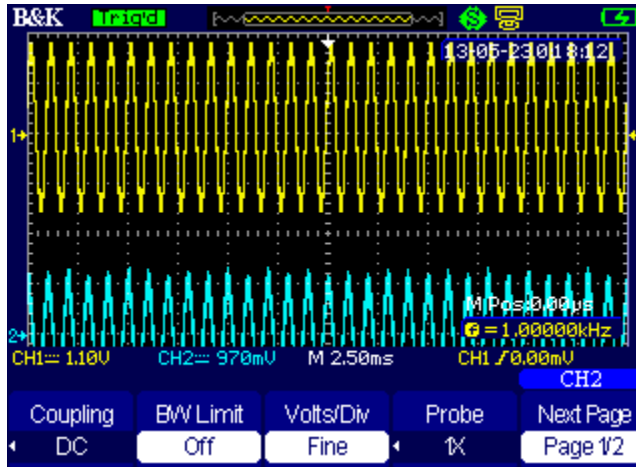

Figure 32 - Fine Control Volts/Div

## Reference Waveform Menu

The instrument can save and display two reference waveforms from both channel 1 and/or channel 2. A reference waveform copies the source waveforms' vertical position, vertical scale factor, horizontal position, and horizontal scale factor.

To access the **Reference** menu, press **Scope** and **F5** to select **Ref.**

Below is a table of the **Reference** menu structure.



Table 14 - Reference Waveform Menu

Menu Option	Setting	Description
Source	CH1/CH1 Off CH2/CH2 Off	Choose the channel to save as a reference waveform.
	Ref A Ref B	Choose to save or recall reference A or reference B waveform.
	Save	Save the source waveform to the selected reference (A or B).

Ref A/Ref B	On Off	Toggles displaying the reference waveform.
-------------	-----------	--

**Note:** Under Source, CH1 Off and CH2 Off will be displayed if both channel 1 and 2 are turned Off.

### *Saving a Reference Waveform*

Follow the steps below to save a reference waveform.

1. Setup and adjust all parameters of the waveform exactly as you want saved from channel 1 or channel 2.
2. Go into the **Ref** menu by pressing  and .
3. Under **Source**, select CH1 or CH2 as the waveform you want to save.
4. You can save two reference waveforms, therefore select **REF A** or **REF B** by toggling .
5. Press  to select **Save** and now the reference waveform is saved.
6. To display the waveform, toggle  to turn **On** or **Off**. The below screenshot displays both **REF A** and **REF B** copied from channel 1 and channel 2. **REF A** is in red and **REF B** is in purple.

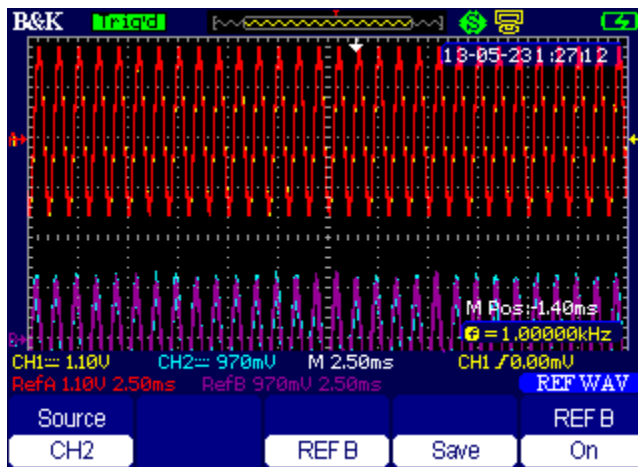



**Figure 33 - Reference Waveforms Display**

## 3.5 Trigger System

There are five types of trigger functions supported by the instrument: edge, pulse, video, slope, and alternative.

### Adjust Trigger Level

To adjust the trigger level in all trigger modes, use the  or  arrow keys to move up or down.

The trigger level position is marked by **←T** on the right of the display. When changed, the screen will temporarily display the trigger level line across the window with the trigger position indicator in the bottom left corner, as illustrated below:

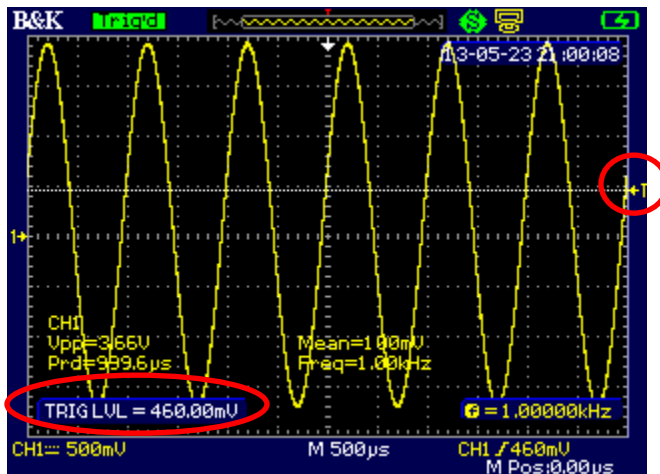



Figure 34 - Trigger Level Display

**Note:** Some options within the trigger menu share the same arrow keys used to adjust the trigger level. In which case, exit the trigger menu by pressing  first, then the arrow keys can be used to change the trigger level.

To access the **Trigger** menu, press . The following describes each type of trigger and the menu options available for setting it up.





## Edge Trigger

Edge trigger seeks to trigger off of a specified slope and level of a waveform.

Select **Edge** under **Type** from the trigger menu.



Table 15 - Edge Trigger Menu

Menu Option	Setting	Description
<b>Type</b>	Edge	Trigger on the rising or falling edge of the input signal.
<b>Source</b>	CH1 CH2	Set CH1 or CH2 as the trigger source.
<b>Slope</b>	  	Trigger on rising edge of the trigger signal. Trigger on falling edge of the trigger signal. Trigger on rising and falling edge of the trigger signal.
<b>Mode</b>	Auto	Use this mode to let the acquisition free-run in the absence of a valid trigger; This mode allows an un-triggered, scanning waveform at 100 ms/div or slower time base settings.
	Normal	Use this mode when you want to see the triggered waveforms only; the scope will not acquire waveform until it's been triggered.
	Single	The setup detects a trigger and acquires waveform, then stops to give a signal capture.
	Set Up	Enter the <b>Edge Trigger Setup Menu</b> .

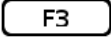

**Table 16 - Edge Trigger Setup Menu**

Menu Option	Setting	Description
<b>Coupling</b>	DC	Passes all components of the signal
	AC	Blocks DC components and attenuates signals below 170 Hz.
	HF Reject	Attenuates the high-frequency components above 140 kHz.
	LF Reject	Blocks the DC component and attenuates the low-frequency components below 7 kHz.
<b>Hold off</b>		Adjusts the hold off time.
<b>Hold off Reset</b>		Reset hold off time to 100 ns.
<b>Return</b>		Return the <b>Edge Trigger Menu</b> .

**Hold Off:** To adjust the hold off time, go to the **Edge Trigger Setup Menu**

and press , then use the  or  arrow keys to adjust the hold off time, which will be displayed when it is adjusted.

Hold off time can be reset to 100 ns by pressing  to select **Hold Off Reset**.

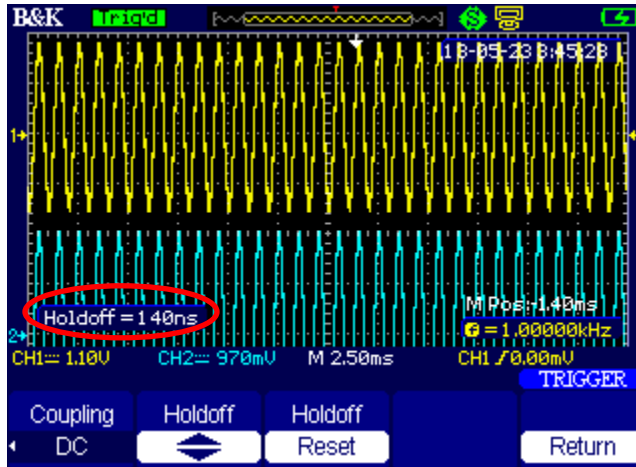

Figure 35 - Hold Off Time Indicator

### ***Pulse Trigger***

Pulse trigger seeks certain pulse conditions of a waveform to trigger.

Select **Pulse** under **Type** from the trigger menu.

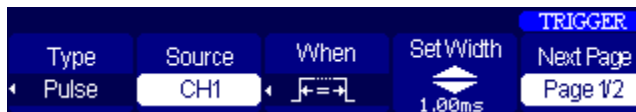

Table 17 - Pulse Trigger Menu 1/2

Menu Option	Setting	Description
Type	Pulse	Select the pulse trigger function.
Source	CH1 CH2	Set CH1 or CH2 as the trigger source.









<b>When</b>	 (Positive pulse width less than pulse width set)  (Positive pulse width larger than pulse width setting)  (Positive pulse width equal to pulse width setting)  (Negative pulse width less than pulse width setting)  (Negative pulse width larger than pulse width setting)  (Negative pulse width equal to pulse width setting)	Select the pulse trigger conditions; it triggers as soon as condition is met.
<b>Set Width</b>	 20.0 ns - 10.0 s	Set the pulse width for pulse trigger condition.
<b>Next Page</b>	Page 1/2	Enter the second page of the <b>Pulse Trigger Menu</b> .



Table 18 - Pulse Trigger Menu 2/2

Menu Option	Setting	Description
<b>Type</b>	Pulse	Select the pulse to trigger the pulse match the trigger condition.
<b>Mode</b>	Auto Normal Single	Select the type of triggering; Normal mode is best for most Pulse Width trigger applications.
<b>Setup</b>		Enter the <b>Pulse Trigger Setup Menu</b> . See Table 16 for details.
<b>Next Page</b>	Page 2/2	Return to the first page of the <b>Pulse Trigger Menu</b> .

To set the pulse width for the pulse trigger condition, press **F4** in the **Pulse Trigger** menu 1 to select **Set Width** and use  or  arrow keys to adjust the width, which will be displayed when it is adjusted.

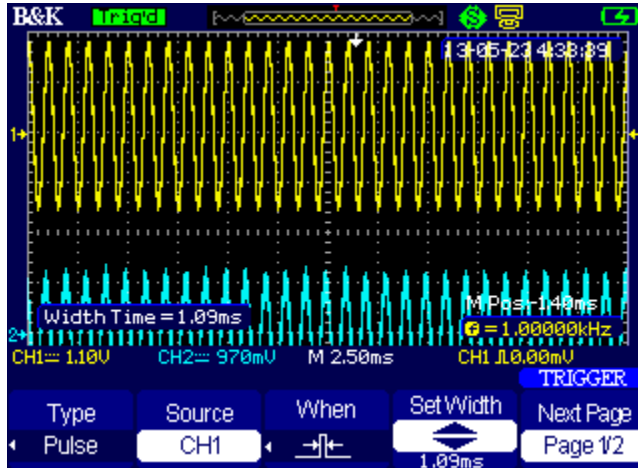

Figure 36 - Pulse Width Trigger Condition Display

**Note:** Trigger level cannot be changed while the Pulse Trigger Menu is active because the SetWidth option shares the same arrow keys to make changes.

### Video Trigger



Video trigger can be used to capture waveforms of standard NTSC and PAL/SECAM analog video signals.

Select **Video** under **Type** from the trigger menu.









Table 19 - Video Trigger Menu 1/2

Menu Option	Setting	Description
-------------	---------	-------------

<b>Type</b>	Video	Select Video trigger. To trigger NTSC, PAL and SECAM video signals, set coupling to AC.
<b>Source</b>	CH1 CH2	Set CH1 or CH2 as the trigger source.
<b>Polarity</b>	 (Normal)	Normal trigger on the negative edge of the sync pulse.
	 (Inverted)	Inverted trigger on the positive edge of the sync pulse.
<b>Sync</b>	All Lines Line Num Odd Field Even Field	Select appropriate video sync.
<b>Next Page</b>	Page 1/2	Enter the second page of <b>Video Trigger Menu</b> .

**Sync:** The bottom right of the display indicates the **Sync** setting the instrument is configured to.

All Lines		The video trigger will sync on all lines of the signal.
Line Num		Select a specific line number for video trigger.
Odd Field		Select only the odd lines for video trigger.
Even Field		Select only the even lines for video trigger.

**Line Num:** To change the line number for video trigger, use the  or  arrow keys. The selected line number will be indicated in the bottom right corner.

**Note:** Trigger level cannot be changed while the Video Trigger Menu is active because the Line Num Sync option shares the same arrow keys to make changes.



Table 20 - Video Trigger Menu 2/2

Menu Option	Setting	Description
Type	Video	When you select type video and select AC coupling, you could trigger to a NTSC, PAL and SECAM video signal.
Standard	NTSC, PAL/SECAM	Select the video standard for sync and line number count.
Mode	Auto	Use this mode to let the acquisition free-run in the absence of a valid trigger. This mode allows an un-triggered, scanning waveform at 100 ms/div or slower time base settings.
	Normal	Use this mode when you want to see only triggered waveforms; the oscilloscope does not display a waveform until after the first trigger.
	Single	Use this mode to run a single capture.
	Setup	Enter the <b>Video Trigger Setup Menu</b> . See Table 16 for details.
Next Page	Page 2/2	Return the first page of <b>Video Trigger Menu</b> .



Table 21 - Video Trigger Setup Menu

Menu Option	Setting	Description
Hold off		Adjusts the hold off time.
Hold off Reset		Reset hold off time to 100 ns.

<b>Return</b>	Return to the <b>Video Trigger Menu</b> .
---------------	---





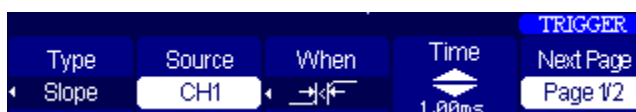

## ***Slope Trigger***

Slope trigger can be used to trigger off a rising or falling edge with specified slope timing conditions and vertical boundaries. It is similar to Edge trigger but with more options users can setup to seek for specific slope conditions from the selected source.

Select **Slope** under **Type** from the trigger menu.

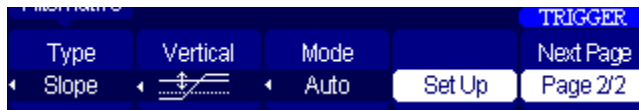

**Table 22 - Slope Trigger Menu 1/2**







<b>Menu Option</b>	<b>Setting</b>	<b>Description</b>
<b>Type</b>	Slope	Trigger on positive slope or negative slope.
<b>Source</b>	CH1 CH2	Select trigger source.
<b>When</b>	 (rising edge greater than slope time)  (rising edge less than slope time)  (rising edge equal to slope time)  (falling edge greater than slope time)  (falling edge less than slope time)  (falling edge equal to slope time)	Select trigger conditions.



<b>Time</b>	 Set time	Use the arrow keys to set slope time. The time range is 20 ns – 10 s.
<b>Next Page</b>	Page 1/2	Enter the second page of the <b>Slope Trigger Menu</b> .



**Table 23 - Slope Trigger Menu 2/2**

<b>Menu Option</b>	<b>Setting</b>	<b>Description</b>
<b>Type</b>	Slope	Select slope trigger.
<b>Vertical</b>	 (Set high trigger level position of rising edge)  (Set low trigger level position of rising edge)  (Set high and low trigger level position of rising edge)  (Set high trigger level position of falling edge)  (Set low trigger level position of falling edge)  (Set high and low trigger level position of falling edge)	Selects the high and low trigger level that can be adjusted for slope trigger. Use this to set the boundaries for the slope trigger.
<b>Mode</b>	Auto	Use this mode to let the acquisition free-run in the absence of a valid trigger; This mode allows an un-triggered, scanning waveform at 100 ms/div or slower time base settings.
	Normal	Use this mode when you want to see only triggered waveforms; the oscilloscope does not display a waveform



		until after the first trigger.
	Single	Use this mode to run a single capture.
	Setup	Enter the <b>Slope Trigger Setup Menu</b> . See Table 16 for details.
<b>Next Page</b>	Page 2/2	Return to the first page of the <b>Slope Trigger Menu</b> .

### **Alternative Trigger**

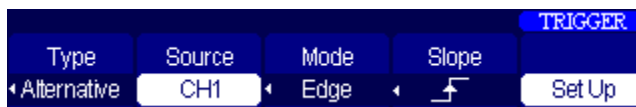
Alternative trigger will alternate the trigger between two channels to allow triggering both channels. Trigger types can be set to Edge, Pulse, Video, and Slope. Trigger information will be displayed at the bottom right of the screen.



**Table 24 - Alternative Trigger Menu**

<b>Menu Option</b>	<b>Setting</b>	<b>Description</b>
<b>Type</b>	Alternative	Select alternative trigger.
<b>Source</b>	CH1 CH2	Select trigger source.
<b>Mode</b>	Edge Pulse Video Slope	Select trigger type for the alternative trigger.
<b>Slope</b>	  	See Table 15 for details.
<b>Next</b>		If <b>Mode</b> is <b>Edge</b> , see Edge Trigger section.

<b>Page/Set up</b>		If <b>Mode</b> is <b>Pulse</b> , see Pulse Trigger section. If <b>Mode</b> is <b>Video</b> , see Edge Trigger section. If <b>Mode</b> is <b>Slope</b> , see Slope Trigger section.
--------------------	--	--

**Table 25 - F4 option in Alternative Trigger Menu**

<b>Menu Option</b>	<b>Setting</b>	<b>Description</b>
<b>Slope</b>		Edge trigger option. See Table 15 for details.
<b>When</b>		Pulse trigger option. See Table 17 for details.
<b>Polarity</b>		Video trigger option. See Table 19 for details.
<b>When</b>		Slope trigger option. See Table 21 for details.

## **3.6 Connecting External Memory**

The instrument supports saving and recalling files of different types, as described in the following section “3.7 Save/Recall Function”, to and from an external USB flash memory drive.

To connect an external USB flash drive, plug the drive into the USB host port on the side of the instrument as labeled in “Figure 4” in section “1.6 Side Panel Overview”.

If the USB flash drive is recognized by the instrument, it will display the following prompt:

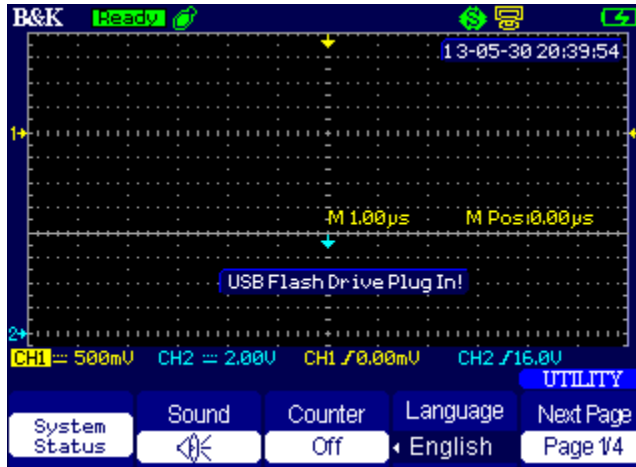

Figure 37 - USB Drive Detected

When the USB flash drive is removed from the USB host port, the following prompt will display:

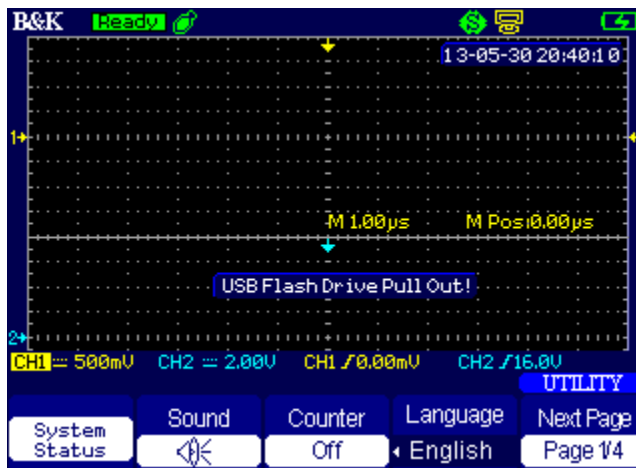

Figure 38 - USB Drive Removed

### 3.7 Save/Recall Function

Instrument setups and waveform traces can be saved and recalled into both internal memory and external memory (USB flash drive). Additionally, screen images and waveform data can be saved as well to external memory.

Enter the **Save/Rec** menu by pressing .



**Table 26 - Save/Recall Menu**

Menu Option	Setting	Description
Type	Setups Waveforms Picture CSV Factory	Select to save instrument settings/setups. Select to save the waveform traces on screen. Select to save the screenshot as a .BMP file. Select to save the waveform data as a .CSV file. Select to set instrument to default settings.
Save to	Device File	Select to save the file into internal memory. Select to save the file into external memory.
Setup	No.1 to No.20	Choose the position number to save/recall setups.
Save		Select to save instrument setups or waveform traces.
Recall		Select to recall instrument setups or waveform traces.

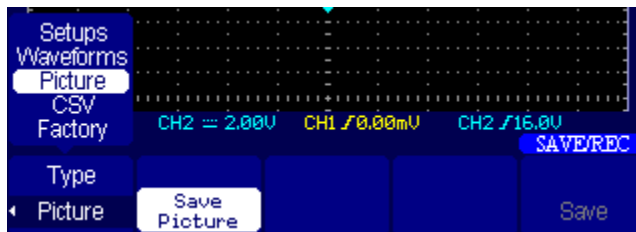

**Table 27 - Save Screenshot Menu**

Menu Option	Setting	Description
Type	Picture	Select to save the screenshot as a .BMP file.
	Save Picture	Select to save screenshot to external memory.
	Print Picture	Print option is not supported.

	Save	Select to save bitmap image to external memory. (This option is available when a USB flash drive is connected and detected by the instrument)
--	------	---

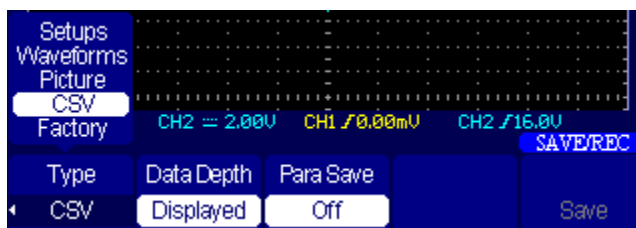

Table 28 – Save Waveform Data Menu

Menu Option	Setting	Description
Type	CSV	Select to save the waveform data as a .CSV file.
Data Depth	Displayed	Select to save only the waveform data displayed within the grid.
	Maximum	Select to save all captured waveform data.
Para Save	On	Choose to save scope parameters in the data file.
	Off	
	Save	Select to save waveform data into external USB flash drive.

**NOTE:**

If Data Depth is set to Maximum, it may take several minutes to complete the save process. Do not press any key during the save process.

### ***Saving and Recalling Setups and Waveforms***

Instrument setups and waveform traces can be saved into internal and external memory.

To save setups and waveforms, follow the steps below:

1. Press  to go into the **Save/Recall** menu, then select **Type**.
2. Toggle  to choose **Setups** to save instrument setups, or choose **Waveforms** to save waveform traces on display.
3. To save the file into internal memory, press  to set **Save To** to **Device**. To save the file to external memory, set it to **File** and go to step 5.
4. If **Save To** is set to **Device**, toggle  to choose the internal memory location to save the file to. There are total of 20 storage locations (No.1 – No.20).
5. Now, press  to **Save** and the current instrument settings will be stored into the configured memory location. If saving to external memory, the directory explorer will display, as shown below. Here, you can choose to create a new directory or new file to save as your file.

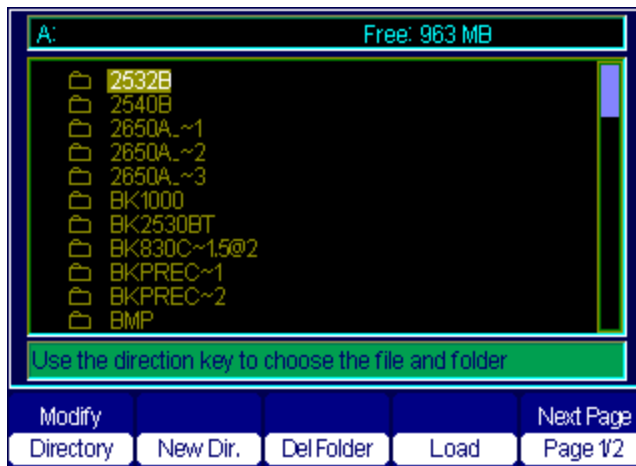

Figure 39 - Directory Menu 1/2

6. To create a new directory, toggle  to set **Modify** option to **Directory**. Then, press  to select **New Dir.** And the following screen will display:

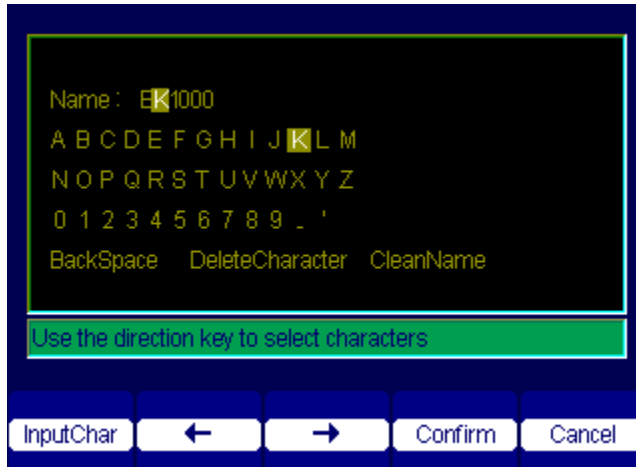



Figure 40 - Create Directory Name

7. You can set the name using the on screen virtual keypad. Use  and  keys to move the cursor position of the name to left and right respectively. To select a character to insert at

the cursor position, use the  and  arrow keys to move the selection cursor to the character you want to select.

8. Then, press  to select **InputChar**. You can also press  arrow key to do the same.
9. To delete a character at the cursor position in the name, select **DeleteCharacter** in the on screen keypad, then press , which will say **Delete Char** when **DeleteCharacter** is selected from the virtual keypad.
10. To save with the configured name, select **Confirm** from the menu by pressing .
11. The folder will be created. Now, to save the file, set **Modify** option to **Files**.
12. Then, press  to select **New File**. Follow the same steps 7-10 to create a file name. The new setup or waveform file will then be created onto the external memory. This process may take 10-15 seconds. A progress bar will be displayed to show the instrument's save progress.



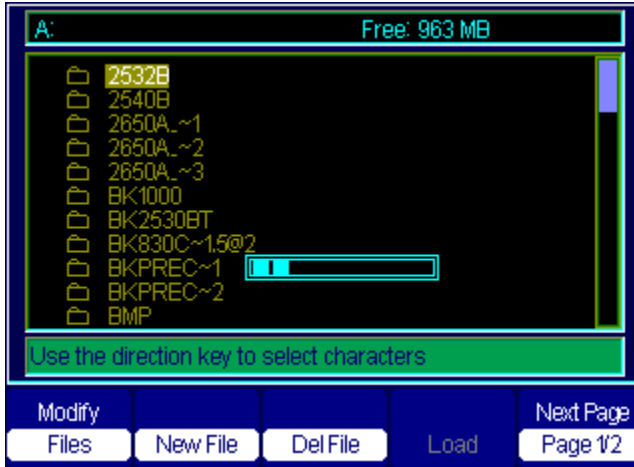

Figure 41 - Save Progress

If the file saves successfully, a message will prompt as shown below:



Figure 42 - Save Successfully

13. If the file name is found to be the same as another file already in the external memory, the instrument will prompt an overwrite warning.

Press  to select **Confirm** to overwrite the file, or press

to select **Cancel**.

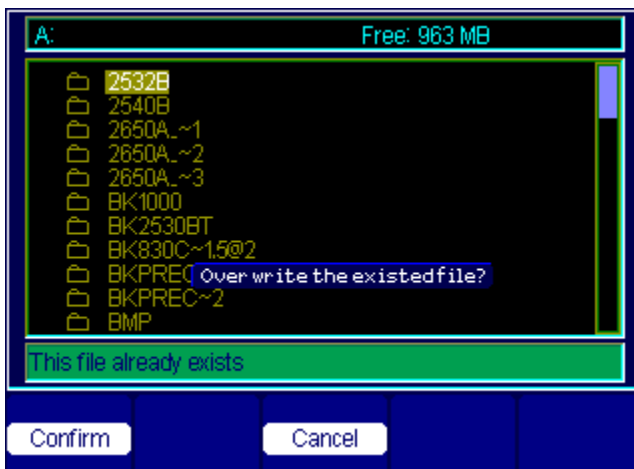



Figure 43 - Overwrite Warning

14. To exit the **Directory** menu, press  to go to **Directory Menu 2**, then press  to select **Return**.

**Note: Instrument setups will be saved as a .SET file and waveform traces will be saved as a .DAV file. Both of these file types can only be recalled from within the oscilloscope Save/Recall menu.**

To recall setups or waveforms, do the following:

1. From the **Save/Recall** menu, select the **Type** to **Setups** or **Waveforms** depending on the type of file you want to recall.
2. Then, set **Save To** as **Device** to recall from internal memory.
3. Select the storage location you want to recall from by pressing  under **Waveform** option, then press  to select **Recall**. The setup or waveform will be recalled from the selected location.
4. To recall from external memory, set **Save To** as **File**, then press  to select **Recall**.
5. The **Directory** menu will come up. Use the  and  arrow keys to highlight the .DAV (waveform) or .SET (setup) file you want to recall, then press  to select **Load**. If the file is within another folder in the directory, select and open the directory



by pressing . To go back up a folder, just press it again with cursor selecting **UP**.

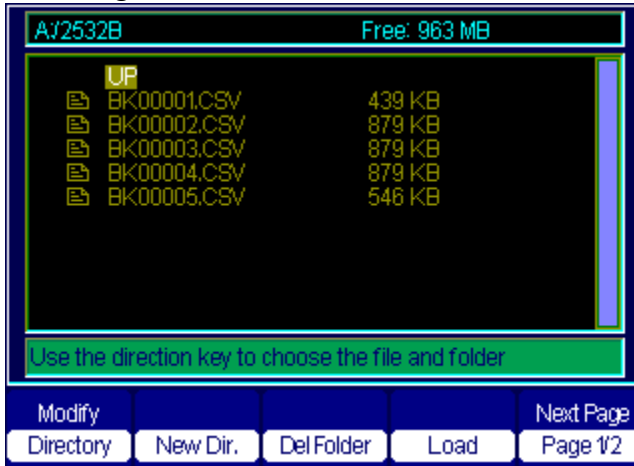

Figure 44 - Subdirectory View

### ***Saving Screen Capture***

The screen capture can be saved as a .BMP file to external memory. To do this, select **Picture** as **Type** from the **Save/Recall** menu. Press  so that it says **Save Picture**. Then press  to select **Save** option. The **Directory** menu will come up.

Similar to the instructions given for saving setups and waveforms to external memory, create a new file and name to save it into the external memory as a .BMP file.

### ***Saving Waveform Data***

Follow the steps below to save waveform data into external memory:

1. From the **Save/Recall** menu, toggle  to select **CSV** for **Type**.

2. Then, select **Data Depth** as **Displayed** or **Maximum**. (See “Table 28” for description of the options)
3. Then, select **Para Save** as **On** or **Off**. Set to **On** if you want scope parameters (i.e. timebase, volts/div) to be saved along with the waveform data.
4. Press  to select **Save**.
5. Similar to saving a screenshot image, setups, and waveform traces as instructed in previous sections above, you will enter the **Directory** menu.
6. Create a new file to save as and the file will be saved to external memory as a .CSV file.

---

**NOTE:**

**If Data Depth is set to Maximum, it may take several minutes to complete the save process. Do not press any key during the save process.**



---

## 3.8 Utility Menu

The utility menu contains menu options for configuring the oscilloscope. To access the menu, press .



Table 29 - Utility Menu 1/4

Menu Option	Setting	Description
System Status		Displays the instrument information.
Sound	<input type="checkbox"/>  <input type="checkbox"/> 	Enable key sound. Disable key sound.
Counter	On Off	Turn ON the frequency counter. Turn OFF the frequency counter.

<b>Language</b>	English, Français, 日本語, 한국의, Deutsch, Español, русский, Italiana, Português, العربية, Polish, 简体中文, 繁體中文	Select the interface language.
<b>Next Page</b>	Page 1/4	Enter the next page of the menu.



**Table 30 - Utility Menu 2/4**

<b>Menu Option</b>	<b>Setting</b>	<b>Description</b>
<b>Do Self Cal</b>		Do a self calibration to calibrate the channels.
<b>Do Self Test</b>	Screen Test Keyboard Test	Run the screen detect program Run the keyboard detect program
<b>Print Setup</b>		Not supported.
<b>USB Device</b>	Printer	Not supported
	Computer	Select to allow remote communication with application software via the miniUSB port on the side panel.
<b>Next Page</b>	Page 2/4	Enter the third page of the menu.



**Table 31 - Utility Menu 3/4**

<b>Menu Option</b>	<b>Setting</b>	<b>Description</b>
	Update firmware	Select to update firmware.

	Record	Press this button to enter the <b>Waveform Record Menu</b> .
<b>Next Page</b>	Page 3/4	Enter the fourth page of the menu.

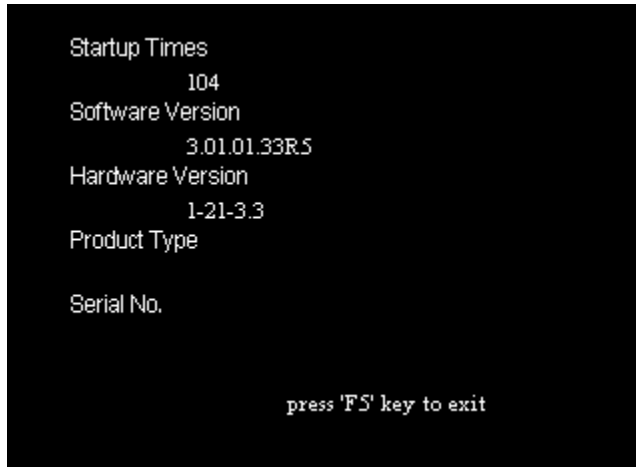

Table 32 - Utility Menu 4/4

Menu Option	Setting	Description
<b>Screen saver</b>	1min, 2min, 5min, 10min, 15min, 30min, 1hour, 2hour, 5hour, Off	Set the screen saver time.
	Date/Time	Configure date and time (see section 2.6 Configure Date and Time).
<b>Next Page</b>	Page4/4	Return to the first page of the menu.

### ***Check System Information***

To check the model information, serial number, software firmware version, and hardware version, enter the **UTILITY** menu by pressing **User**. Then, from **Utility Menu 1/4**, select **System Status** by pressing **F1**. The following screen will display, showing all the system information.



**Figure 45 - System Information Display**

To exit and go back to the main menu, press .

### ***Enable/Disable Key Sound***

The key press sound can be enabled or disabled from the **Utility Menu 1/4**. Press  to toggle the **Sound** option to enable or disable key sound.

### ***Enable/Disable Frequency Counter***

The oscilloscope has a built-in counter to display frequency when a signal from channel 1 or channel 2 is measurable.

To turn it ON or OFF, toggle the  button in **Utility Menu 1/4** to change the **Counter** option. Frequency counter will be displayed in the lower right corner, as illustrated below:

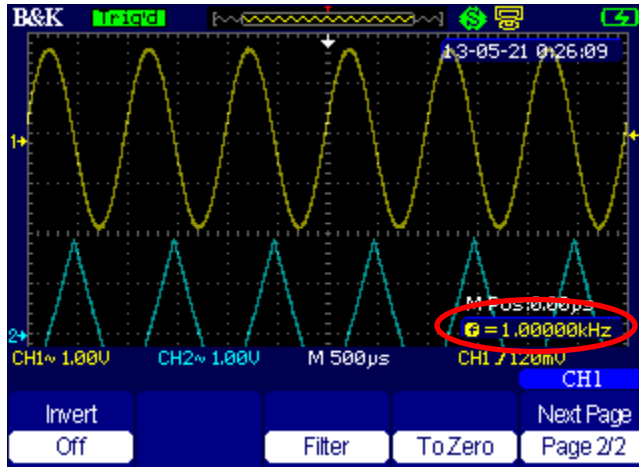

Figure 46 - Frequency Counter Display

## Set the Language

The interface can be displayed in different languages. Supported languages are: English, French, Japanese, Korean, German, Spanish, Russian, Italian, Portuguese, Arabic, Polish, Simplified Chinese, and Traditional Chinese.

From the **Utility Menu 1/4**, toggle  to change the language.



## Updating Firmware

Firmware updates are available on B&K Precision's website at [www.bkprecision.com](http://www.bkprecision.com).

To update the firmware, do the following:

1. Download the firmware file from [www.bkprecision.com](http://www.bkprecision.com)
2. Save the firmware file to a USB flash drive. The file will have an .ADS extension.
3. Power On the instrument and connect the USB flash drive to the USB host port on the side of the instrument (See "1.6 Side Panel Overview" for details).

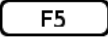
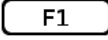
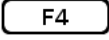
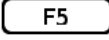

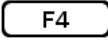

4. Press  to enter the **Utility Menu** and press  to go to page 3/4 of the menu.
5. **Select Update Firmware by pressing** .
6. To proceed, press . Otherwise, press  to exit out of the firmware update menu.
7. From the **Directory** menu, use the  and  arrow keys to select the firmware file stored in the USB flash drive.
8. Once selected, select **Load** by pressing .
9. At this point, the instrument will begin updating the firmware.

---

**WARNING:**

**Do not power off the instrument or press any of the front panel keys at any time during the update process. Any power interruption or key press interruption may damage the instrument or corrupt the firmware, causing it to malfunction and void the warranty.**

---

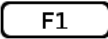
10. Wait for 1-2 minutes for the update to finish. A progress bar on the display will indicate when update is complete.
11. When finished, a prompt will say "Update Successfully" and will prompt the user to reboot the instrument.
12. At this point, power off the instrument by holding down  for at least three seconds, then power back on again.
13. To verify that the instrument has updated successfully, press  to go to the **Utility** menu and press  from page 1 of the menu to select **System Status**.

## ***Set Screen Saver***

The instrument has a screen saver mode to save power when the instrument is idle or not in use. The timer to enable the screen saver can be configured by going to page 4 of the **Utility** menu and pressing  to select **Screen saver** option. Toggle this to change the screen saver timer.

Select **Off** to disable the screen saver.

## ***Waveform Record Function***

The waveform record function can record channel 1 or channel 2 input signals frame by frame from 1 up to 2500 frames. The recorded frames can be played back for analysis.

---

### **NOTE:**

**Record function is not available when Alternative Trigger is selected. Single trigger is also not supported when using this function.**





---

To access the waveform record function, press  and press  to get to **Utility** menu page 3. Press  to select **Record** to enter the **Record** menu.







By default, **Mode** is set to **Off**, so no other menu options will be available. To configure the waveform record function, press  to select **Record** for **Mode**.

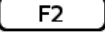
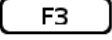

**Table 33 - Waveform Record Menu**

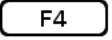
Menu Option	Setting	Description
<b>Mode</b>	Record Replay Off	Set to configure and record. Set to playback recorded waveform. Turn off waveform record menu.
<b>Source</b>	CH1, CH2	Choose recorder source.
<b>Interval</b>		Set interval to record waveform. (1 ms – 1000 s)
<b>End Frame</b>		Set the maximum number of frames to record. (1 – 2500)
<b>Operate</b>		Start to record
		Stop recording

### ***Configure Waveform Record***

1. Select the source to record by toggling  to select **CH1** or **CH2** for **Source** option.
2. Select the interval to which to record a frame by pressing   
first to select **Interval**, then use the  and  arrow keys to change the interval time.
3. Press  to select **End Frame** to set the number of frames to record. Use the  and  arrow keys to change the number.
4. To begin recording, press  so that under **Operate** menu option, it shows the  icon. This indicates that the waveform is being recorded.

An indicator at the top left of the grid display will indicate the approximate frame count of the recording.

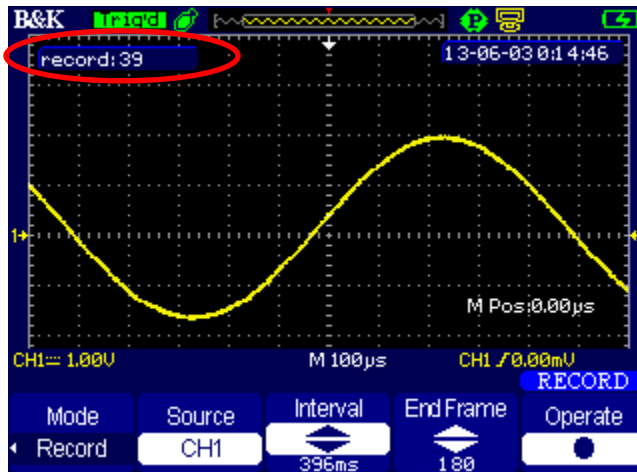

Figure 47 - Record Frame Indicator

When recording is finished, the following message will be prompted:

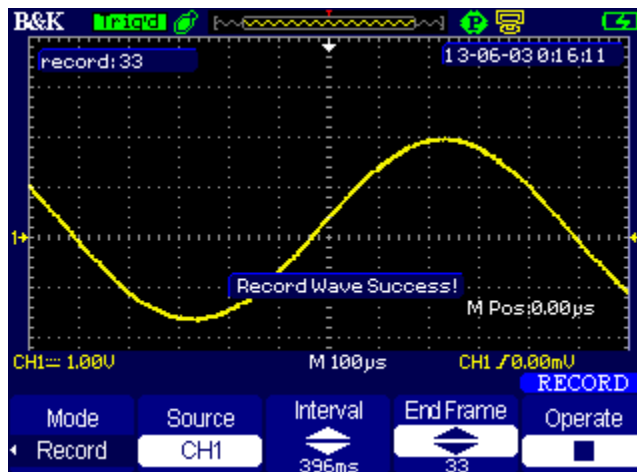

Figure 48 - Recording Finished

## Playback Recorded Waveform

To playback a recorded waveform, select **Playback** for **Mode** in the **Waveform Record** menu. **Playback** menu options are available to configure playback. Once configured, press F2 in page 1 of the menu to start playback. Press it once more to stop playback at any time.



Table 34 - Waveform Playback Menu 1/2









Menu Option	Setting	Description
Mode	Play Back	Set to playback recorded waveform.
Operate	 	Press to start playback. Press to stop playback.
Play Mode	 	Set to repeat playback. Set to run playback one time.
Interval		Set interval between frames during playback.
Next Page	Page 1/2	Enter the second page of the menu.



Table 35 - Waveform Playback Menu 2/2

Menu Option	Setting	Description
Start Frame		Set start frame.
Curr_Frame		Select current frame to be played.

<b>End Frame</b>		Set end frame.
	Return	Press to exit back to the <b>Utility</b> menu.
<b>Next Page</b>	Page 2/2	Return to the first page of the <b>Playback</b> menu.

## 3.9 Measurement and Cursor Functions

### *Measurement Functions*

---

**NOTE:**

**The measurement function will not make automatic measurements when the instrument is in SCAN mode.  
Time base must be  $\leq 50$  ms.**

---

The instrument has many built-in automatic measurement functions available, which are categorized by voltage measurements, time measurements, and delay measurements.

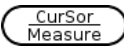
To access the measurement function menu, press  until the **Measure** menu is displayed.

				MEASURE
CH1 Vpp 3.64V	CH1 Vmax 1.96V	CH1 Vmin -1.68V	CH1 Period ****	CH1 Freq ****

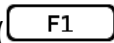
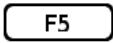
By default, the menu options will show five different measurements in the menu display area. Each of these 5 measurements can be changed to show different measurements by selecting its corresponding function key ( - ).

In the **Measure** menu, press any of the function keys to go to the measurement selection menu, as shown below.



**Table 36 - Measurement Selection Menu**

Menu Option	Description
<b>Voltage</b>	Press this button to enter the Voltage measure menu.
<b>Time</b>	Press this button to enter the Time measure menu.
<b>Delay</b>	Press this button to enter the Delay measure menu.
<b>All Mea</b>	Press this button to enter the All Measurement menu.
<b>Return</b>	Return to the <b>Measure</b> menu.















Select the measurement parameters, then configure the type of measurement to display. When finished, press **F5** **Return** option to go back to the **Measure** menu, and the corresponding menu option will now display the selected Measurement Parameter.

### ***Voltage Measurement Parameters***



**Table 37 - Voltage Measurement Parameters Menu**

Menu Option	Setting	Description
<b>Source</b>	CH1,CH2	Select input signal source for voltage measurement.
<b>Type</b>	Vpp, Vmax, Vmin, Vamp, Vtop, Vbase, Vavg, Mean, Vrms, Crms, FOV, FPRE, ROV, RPRE	Select the type of voltage measurement.
		Display the corresponding icon for the selected voltage measurement as well as the measured value.
	Return	Return to the <b>Measure</b> menu.

	Vpp – Voltage peak-to-peak		Mean – Arithmetic mean over the entire waveform
	Vmax – Positive peak voltage		Vrms – True rms voltage over the entire waveform
	Vmin – Negative peak voltage		Crms – rms voltage of the first cycle of the waveform
	Vamp – Vtop and Vbase difference		FOV – Falling edge overshoot voltage $FOV = \frac{V_{min} - V_{base}}{V_{amp}}$
	Vtop – Max. voltage during measurement		FPRE – Falling edge preshoot $FPRE = \frac{V_{max} - V_{top}}{V_{amp}}$
	Vbase – Min. voltage during measurement		ROV – Rising edge overshoot voltage $ROV = \frac{V_{max} - V_{top}}{V_{amp}}$
	Vavg – Average voltage over first cycle		RPRE – Rising edge preshoot $RPRE = \frac{V_{min} - V_{base}}{V_{amp}}$

### Time Measurement Parameters



Table 38 - Time Measurement Parameters Menu

Menu Option	Setting	Description
Source	CH1, CH2	Select input signal source for Time measure.
Type	Period, Freq, +Wid, -Wid, Rise Time, Fall Time, BWid, +Dut, -	Select the type of time measurement.



	Dut	
		Display the corresponding icon for the selected time measurement as well as the measured value.
	Return	Return to the <b>Measure</b> menu.

	Period – Period of the signal		Fall Time – Time between voltage level falling from 90% to 10%
	Freq – Frequency of the signal		BWid – Duration of a burst over entire waveform
	+Wid – Time between first rising edge and next falling edge at 50% voltage level		+Dut – Ratio between first positive pulse width and period
	-Wid – Time between first falling edge and next rising edge at 50% voltage level		-Dut – Ratio between first negative pulse width and period
	Rise Time – Time between voltage level rising from 10% to 90%		







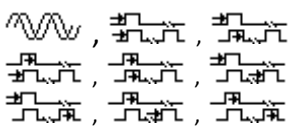

### Delay Measurement Parameters



Table 39 - Delay Measurement Parameters Menu

Menu option	Setting	Description
Source	CH1, CH2	Select input signal source for delay measure.
Type	Phase, FRR, FRF, FFR, FFF,	Select the type of delay

	LRR, LRF, LFR, LFF	measurement.
		Display the corresponding icon for the selected delay measurement as well as the measured value.
	Return	Return to the <b>Measure</b> menu.

	Phase – Phase difference between two waveforms		LRR – Time between first rising edge of CH1 and last rising edge of CH2
	FRR – Time between first rising edge of CH1 and first rising edge of CH2		LRF – Time between first rising edge of CH1 and last falling edge of CH2
	FRF – Time between first rising edge of CH1 and first falling edge of CH2		LFR – Time between first falling edge of CH1 and last rising edge of CH2
	FFR – Time between first falling edge of CH1 and first rising edge of CH2		LFF – Time between first falling edge of CH1 and last falling edge of CH2
	FFF – Time between first falling edge of CH1 and first falling edge of CH2		

### ***Display All Measurements***

You can enable all voltage measurements, all time measurements, or all delay measurements to display on the screen. You can also show all 32 total automatic measurements on the display.

From the **Measure** menu, press  to select **All Mea**. Then, select the single source to show its corresponding measurements by toggling  to set **Source** as **CH1** or **CH2**. Press  to toggle **On** or **Off** displaying all voltage measurements. Press  to toggle **On** or **Off** displaying all time measurements. Press  to toggle **On** or **Off** displaying all delay measurements.

				MEASURE
Source	Voltage	Time	Delay	
CH1	Off	Off	Off	Return

Table 40 - All Measurement Display Menu

Menu option	Setting	Description
Source	CH1, CH2	Select input signal source for delay measure.
Voltage	On Off	Select to enable/disable displaying all voltage measurements.
Time	On Off	Select to enable/disable displaying all voltage measurements.
Delay	On Off	Select to enable/disable displaying all delay measurements.
	Return	Return to the <b>Measure</b> menu.

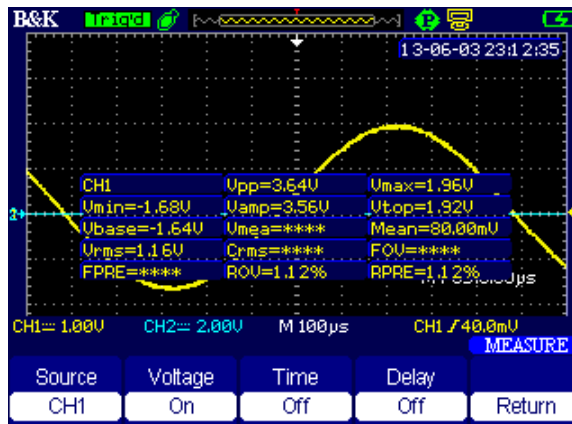

Figure 49 - All Voltage Measurements Display

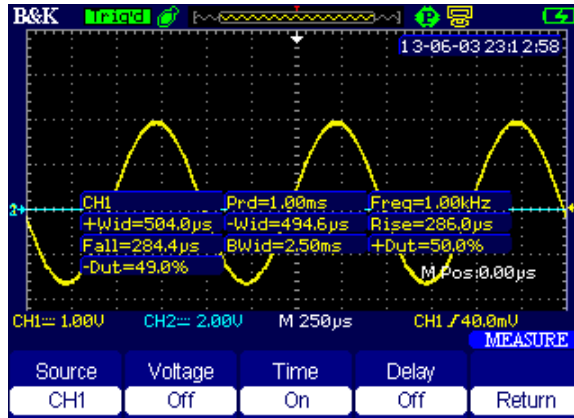

Figure 50 - All Time Measurements Display

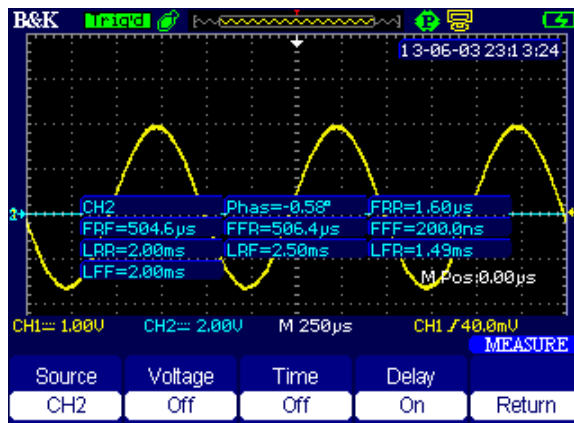

Figure 51 - All Delay Measurements Display

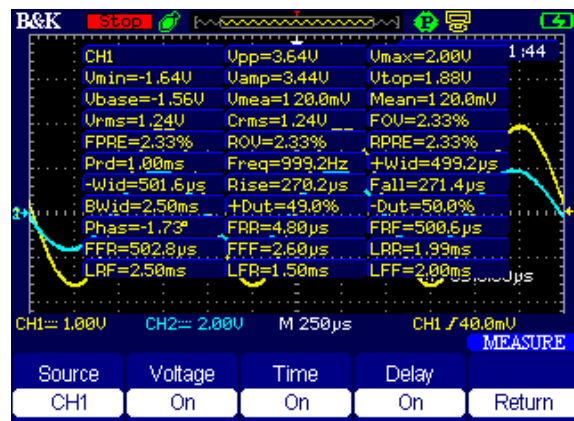
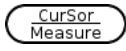

Figure 52 - All Measurements Display

## Cursor Functions

Toggle the  button to enter the **Cursor** menu.



There are three cursor modes available: Manual, Track, and Auto.

To disable cursors, set **Mode** to **Off**.

### Manual Cursor Mode

Manual cursor mode allows users to set either horizontal or vertical cursors to make measurements from a selected signal source.

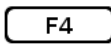
From the **Cursor** menu, set **Mode** to **Manual**. Select the **Type** of cursor for the measurement, and select **Source**.

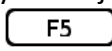

To adjust **Cursor A**, select it with  to that it's highlighted, then use the  and  arrow keys to adjust its position. Do the same to adjust **Cursor B** by selecting it with .

**Note:** **MATH**, **REFA**, and **REFB** are not selectable as **Source** unless they are enabled. Refer to “3.4 Scope Menu” to enable them.



Table 41 - Manual Cursor Menu

Menu Option	Setting	Description
<b>Mode</b>	Manual	Set to manual cursor mode.
<b>Type</b>	Voltage	Use cursors to measure voltage parameters.
	Time	Use cursors to measure time parameters.
<b>Source</b>	CH1, CH2,	Choose the signal source to measure with

	MATH, REFA, REFB	cursors.
Cur A		Adjust cursor A position.
Cur B		Adjust cursor B position.

**Voltage Type** – Voltage cursors are used to make cursor measurements. Two horizontal cursor lines will appear on the display, and their positions and differences will be indicated in the upper left corner of the display.

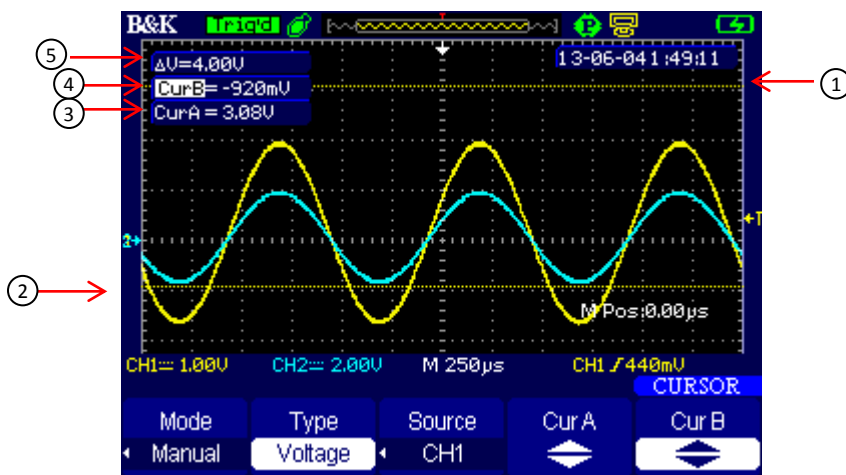

Figure 53 - Manual Voltage Cursor

- 
- ① Cursor A
- 
- ② Cursor B
- 
- ③ Cursor A position
- 
- ④ Cursor B position
- 
- ⑤ Voltage difference between Cursor A and Cursor B
-

**Time Type** – Time cursors are used to make cursor measurements. Two vertical cursor lines will appear on the display, and their positions and differences will be indicated in the upper left corner of the display.

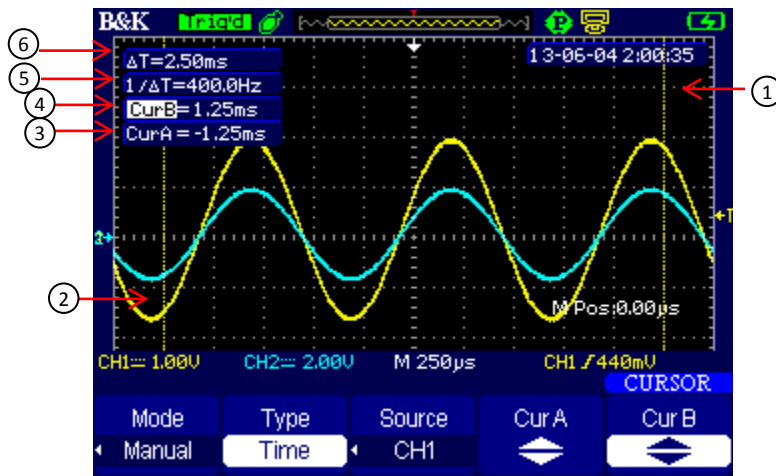



Figure 54 - Manual Time Cursor

①	Cursor B
②	Cursor A
③	Cursor A time position
④	Cursor B time position
⑤	Frequency between Cursor A and Cursor B
⑥	Time difference between Cursor A and Cursor B

## Track Cursor Mode

Track cursor mode allows users to setup two cursors with both time and voltage tracked from selected signal sources.

From the **Cursor** menu, set **Mode** to **Track**. Select the source for **Cursor A** and the source for **Cursor B** by toggling **F2** and **F3** respectively.

To adjust **Cursor A**, select it with **F4** to that it's highlighted, then use the  and  arrow keys to adjust its position. Do the same to adjust **Cursor B** by selecting it with **F5**.

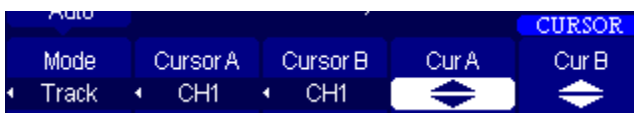



Table 42 - Track Cursor Menu

Menu Option	Setting	Description
Mode	Track	Set to track cursor mode.
Cursor A	CH1, CH2, NONE	Select signal source for cursor A to measure.
Cursor B	CH1, CH2, NONE	Select signal source for cursor B to measure.
Cur A		Adjust cursor A position.
Cur B		Adjust cursor B position.



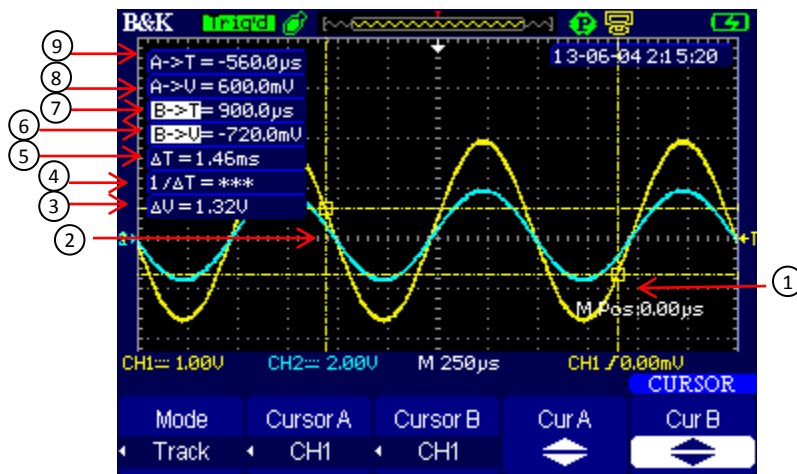

Figure 55 - Track Cursor Display

- 
- ① Cursor B
- 
- ② Cursor A
- 
- ③ Voltage difference between Cursor A and Cursor B
- 
- ④ Frequency between Cursor A and Cursor B
- 
- ⑤ Time difference between Cursor A and Cursor B
- 
- ⑥ Cursor B voltage position
- 
- ⑦ Cursor B time position
- 
- ⑧ Cursor A voltage position
- 
- ⑨ Cursor A time position
- 

### ***Auto Cursor Mode***

Auto cursor mode is used for automatic measurements only. When selecting **Mode** as **Auto** from the **Cursor** menu, no additional menu options will appear.



In this mode, the cursor(s) will be displayed when selecting automatic measurements.

For example, toggle CurSor  
Measure to go to **Measure** menu.



Select any of the five measurements displayed in the menu display area, then select any measurement parameter types.

Selecting **Vpp** as the voltage measurement **Type** will show the following display, with two cursors shown on display to illustrate their positions to which the measurements are being made.

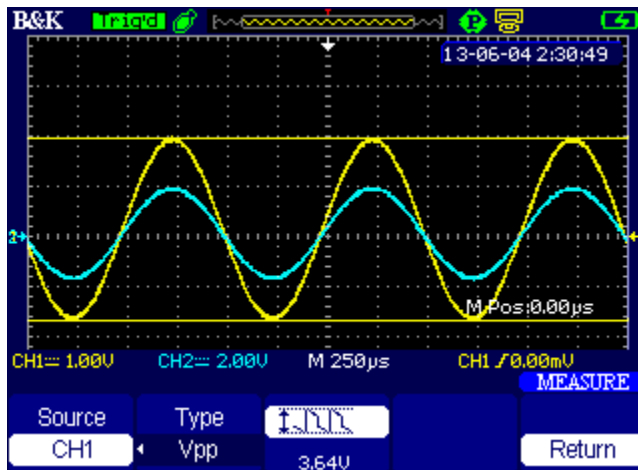

Figure 56 - Auto Cursor Measuring Vpp

Selecting **Period** as the time measurement **Type** will show the following display, with two cursors shown on display to illustrate their positions to which the measurements are being made.

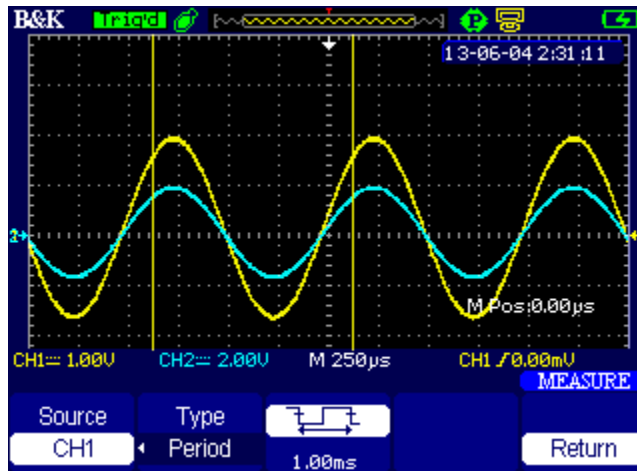

Figure 57 - Auto Cursor Measuring Period

---

**Note: Auto cursor mode does not support displaying cursors for multiple measurements.**

---

## 4 Using the Digital Multimeter

The handheld digital storage oscilloscope has a built-in multimeter that can measure DC and AC voltage, DC and AC current, resistance, diode, continuity, and capacitance.

To set the instrument to the digital multimeter mode, press Meter, and the display will enter the multimeter display, as shown below.

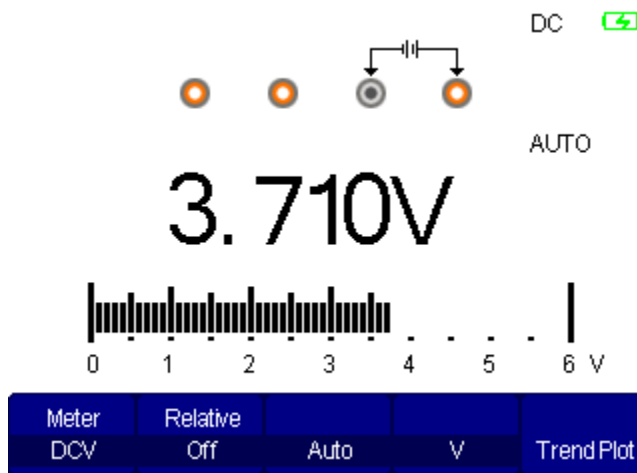
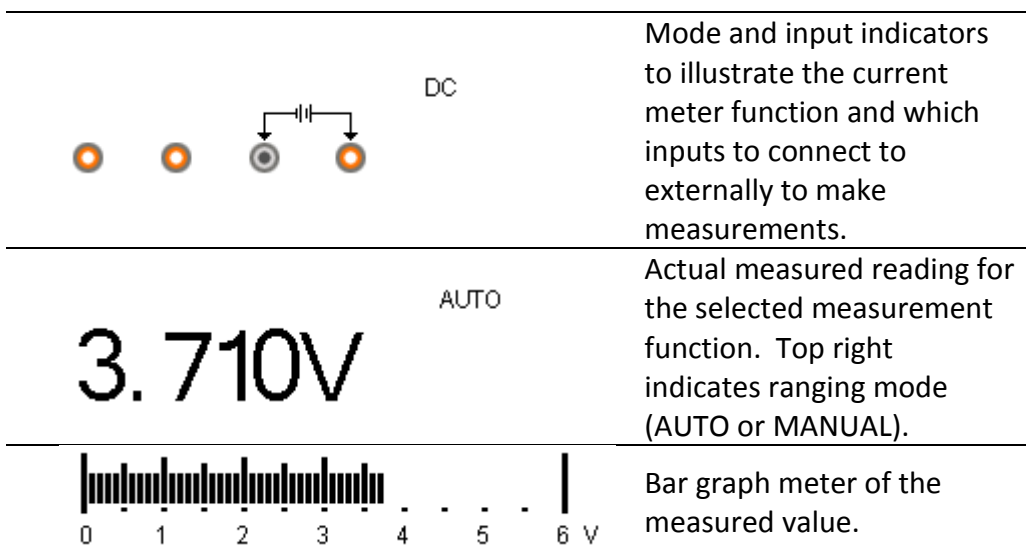

Figure 58 - Multimeter Display



Mode and input indicators to illustrate the current meter function and which inputs to connect to externally to make measurements.

Actual measured reading for the selected measurement function. Top right indicates ranging mode (AUTO or MANUAL).

Bar graph meter of the measured value.

---

**Note:** In the digital multimeter mode, only the function keys (  -  ),  , and



keys are active. All other front panel keys, besides  and  are inactive and are unused.

---

**CAUTION:**

Always use only the included test leads to make measurements. Verify that test leads are in proper working conditions and that they meet the specified electrical ratings and input requirements of the instrument.

---

## 4.1 DC and AC Voltage Measurements

To measure DC voltages, press  repeatedly until **Meter** is set to **DCV**.

Meter	Relative			
DCV	Off	Auto	V	Trend Plot

To measure AC voltages, press  repeatedly until **Meter** is set to **ACV**.

Meter	Relative			
ACV	Off	Auto	V	Trend Plot

Table 43 – DC/AC Voltage Measurement Menu

Menu Option	Setting	Description
Relative	On	Save the current input value as a reference value. Subsequent measurements will be the difference from the reference value. This is same as “zeroing” the meter.
	Off	Relative mode is disabled.
	Auto	Select to enable autoranging.
	Manual	Select to enable manual ranging.
	V	Display measurement in volts (V). In manual ranging, only the volts (V) ranges are selectable.
	mV	Display measurement in millivolts (mV). In manual ranging, only the millivolts (mV) ranges are selectable.
	Trend Plot	Enters the <b>Meter Trend plot</b> mode (See “Meter Trend Plot” for more information).

## DC Voltage Measurement

Configure all settings from the menu.

When set for **Manual** ranging (select **Manual** by toggling ), use the



key to increase the range. At the highest range, pressing this will automatically go back to the lowest range.

**DC Voltage ranges:** 60 mV, 600 mV, 6 V, 60 V, 600 V, 1000 V.

---

**NOTE: When the measurement unit is changed, range will automatically change to Auto ranging.**

---



---

**NOTE: If the measurement is out of range or if manual range is used and the measurement is outside of the selected range, the instrument will beep continuously. The measurement display will show 0.L.**

---

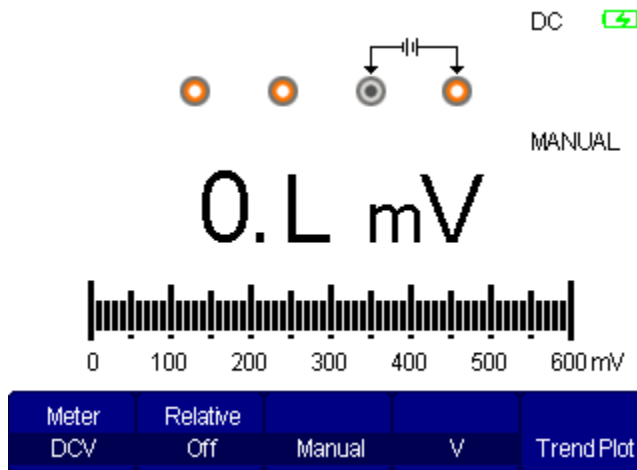

Figure 59 - Out of Range

**CAUTION:**

**Always connect the test leads to the instrument inputs first before probing the DUT to avoid potential shock hazard.**

Follow these steps to make a measurement.

1. Connect the negative (-) side with the black test lead to the **COM** input.
2. Connect the positive (+) side with the red test lead to the **V.Ω.C** input.
3. Probe with the test leads to the DUT and take the measured reading on display.

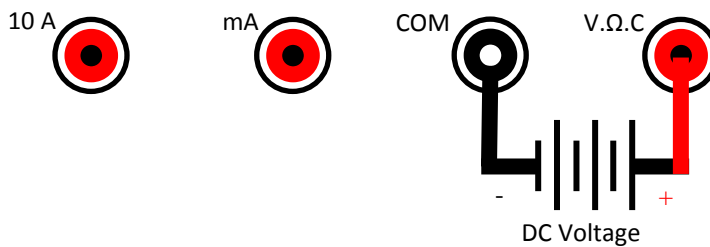

Figure 60 - Connection for DC Voltage Measurement

---

**WARNING:**

**Never connect more than 1000V DC across the input terminals.**

---

## ***AC Voltage Measurements***

AC voltage measurements use the same setup as DC voltage measurements.

Configure all settings from the menu.

When set for **Manual** ranging (select **Manual** by toggling ) , use the



key to increase the range. At the highest range, pressing this will automatically go back to the lowest range.

**AC Voltage ranges:** 60 mV, 600 mV, 6 V, 60 V, 600 V, 750 V.

---

**NOTE: When the measurement unit is changed, range will automatically change to Auto ranging.**

---

---

**CAUTION:**

**Always connect the test leads to the instrument inputs first before probing the DUT to avoid potential shock hazard.**

---

Follow these steps to make a measurement.

1. Connect the black test lead to the **COM** input.
2. Connect the red test lead to the **V.Ω.C** input.
3. Probe with the test leads to the DUT and take the measured reading on display.

---

**NOTE: If the measurement is out of range or if manual range is used and the measurement is outside of the selected range, the instrument will beep continuously.**

---



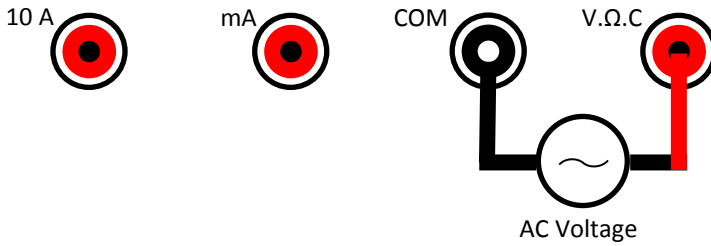

Figure 61 - Connection for AC Voltage Measurement

**WARNING:**

Never connect more than 750V AC across the input terminals.

## 4.2 DC and AC Current Measurements

To measure DC current, press  repeatedly until **Meter** is set to **DCI**.

Meter	Relative			
DCI	Off	Auto	A	Trend Plot

To measure AC current, press  repeatedly until **Meter** is set to **ACI**.

Meter	Relative			
ACI	Off	Auto	A	Trend Plot

Table 44 – DC/AC Current Measurement Menu

Menu Option	Setting	Description
Relative	On	Save the current input value as a reference value. Subsequent measurements will be the difference from the reference value. This is the same as “zeroing” the meter.
	Off	Relative mode is disabled.
	Auto	Select to enable autoranging.
	Manual	Select to enable manual ranging.
	A	Display measurement in amps (A). In manual

		ranging, only the amp (A) ranges are selectable.
	mA	Display measurement in milliamps (mA). In manual ranging, only the milliamp (mA) ranges are selectable.
	Trend Plot	Enters the <b>Meter Trend plot</b> mode (See “Meter Trend Plot” for more information).

## DC Current Measurements

Current measurements can be made in low current or high current mode. In low current measurement mode you can measure up to 600 mA. Connect to the low current **mA** terminal and select one of the two ranges. In high current measurement mode, you can measure up to 10 A by selecting one of the two ranges and connecting to the **10A** input terminal.

Configure all settings from the menu.

When set for **Manual** ranging (select **Manual** by toggling ) , use the



key to increase the range. At the highest range, pressing this will automatically go back to the lowest range.

**DC Current ranges:** 60 mA (low), 600 mA (low), 6 A (high), and 10 A (high).

---

### CAUTION:

**Always connect the test leads to the instrument inputs first before connecting the DUT to avoid potential shock hazard.**

---

## Low Current Measurements (< 600 mA)

Follow these steps to make measurements < 600 mA.

1. Connect the negative (-) side with the black test lead to the **COM** input.
2. Connect the positive (+) side with the red test lead to the **mA** input.
3. Probe with the test leads to the DUT and take the measured reading on display.

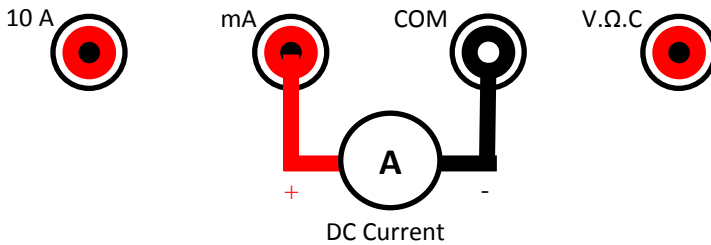

Figure 62 - Connection for Low DC Current Measurement

---

**WARNING:**

Do not connect more than 600 mA DC current across the mA input terminal or the protection fuse will trip. Never input 10 A or more current across the terminal or the instrument will be damaged and warranty will be void.

---

***Higher Current Measurements (Up to 10 A)***

Follow these steps to make measurements up to 10 A.

1. Connect the negative (-) side with the black test lead to the **COM** input.
2. Connect the positive (+) side with the red test lead to the **10A** input.
3. Probe with the test leads to the DUT and take the measured reading on display.

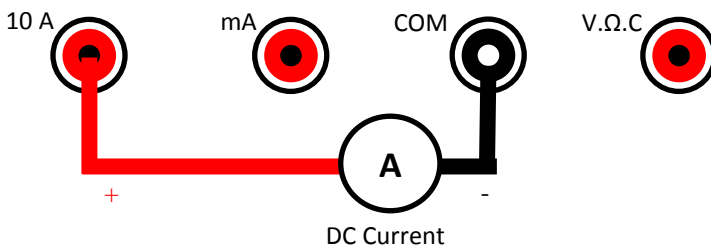

Figure 63 - Connection for Higher DC Current Measurement

---

**WARNING:**

**Do not connect more than 10 A DC current across the 10A input terminal or the protection fuse will be tripped.**

---

### ***Make AC Current Measurements***

For current measurements, the low current measurement mode supports two ranges. Use the low current **mA** input terminal to measure current up to 600 mA. High current measurements also support two ranges. In this mode you can measure up to 10 A by connecting to the **10A** input terminal.

**AC Current ranges:** 60 mA (low), 600 mA (low), 6 A (high), and 10 A (high).

---

**CAUTION:**

**Always connect the test leads to the instrument inputs first before connecting the DUT to avoid potential shock hazard.**

---

### ***Low Current Measurements (< 600 mA)***

Follow these steps to make measurements < 600 mA.

1. Connect the black test lead to the **COM** input.
2. Connect the red test lead to the **mA** input.
3. Probe with the test leads to the DUT and take the measured reading on display.

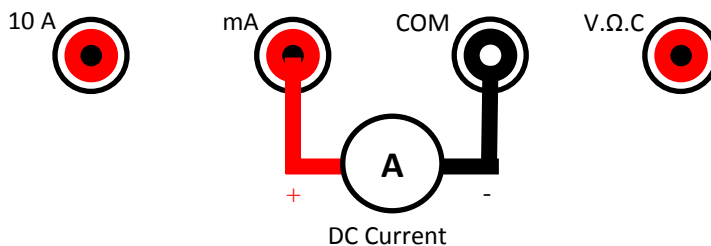

**Figure 64 - Connection for Low AC Current Measurement**

---

**WARNING:**

Do not connect more than 600 mA AC current across the mA input terminal or the protection fuse will be tripped. Never input 10 A or more current across the terminal or the instrument will be damaged and warranty will be void.

---

### *Higher Current Measurements (Up to 10 A)*

Follow these steps to make measurements up to 10 A.

1. Connect the black test lead to the **COM** input.
2. Connect the red test lead to the **10A** input.
3. Probe with the test leads to the DUT and take the measured reading on display.

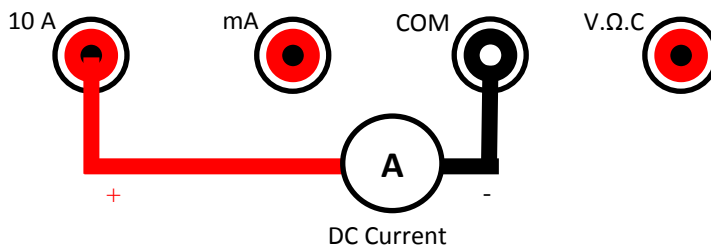

Figure 65 - Connection for Higher AC Current Measurement

---

**WARNING:**

Do not connect more than 10 A DC current across the 10A input terminal or the protection fuse will be tripped.

---

## 4.3 Make Resistance Measurements

To measure resistances, press F1 repeatedly until **Meter** is set to “Res.”.

Meter	Relative			
Res.	Off	Manual		Trend Plot

Table 45 – Resistance Measurement Menu

Menu Option	Setting	Description
Relative	On	Save the current input value as a reference value. Subsequent measurements will be the difference from the reference value. This is same as “zeroing” the meter.
	Off	Relative mode is disabled.
	Auto	Select to enable autoranging.
	Manual	Select to enable manual ranging.
	V	Display measurement in volts (V). In manual ranging, only the volts (V) ranges are selectable.
	mV	Display measurement in millivolts (mV). In manual ranging, only the millivolts (mV) ranges are selectable.
	Trend Plot	Enters the <b>Meter Trend plot</b> mode (See “Meter Trend Plot” for more information).

Configure all settings from the menu.

When set for **Manual** ranging (select **Manual** by toggling F3), use the



key to increase the range. At the highest range, pressing this will automatically go back to the lowest range.

**Resistance ranges:** 600 Ω, 6 kΩ, 60 kΩ, 600 kΩ, 6 MΩ, and 60 MΩ.

---

**NOTE: When the measurement unit is changed, range will automatically change to Auto ranging.**

---

---

**CAUTION:**

**Always connect the test leads to the instrument inputs first before connecting the DUT to avoid potential shock hazard.**

---

Follow these steps to make a measurement.

1. Connect the black test lead to the **COM** input.
2. Connect the red test lead to the **V.Ω.C** input.
3. Probe with the test leads to the DUT and take the measured reading on display.

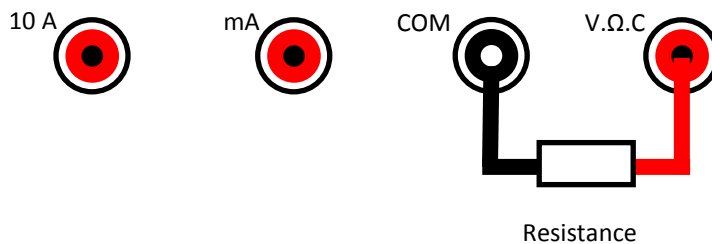

**Figure 66 - Connection for Resistance Measurement**

---

**WARNING:**

**Do not apply more than 1000 VDC across the terminals or they will be damaged.**

---

## 4.4 Make Diode Measurements

The instrument can measure the forward voltage of general purpose diodes.

To measure diodes, press F1 repeatedly until **Meter** is set to **Diode**.

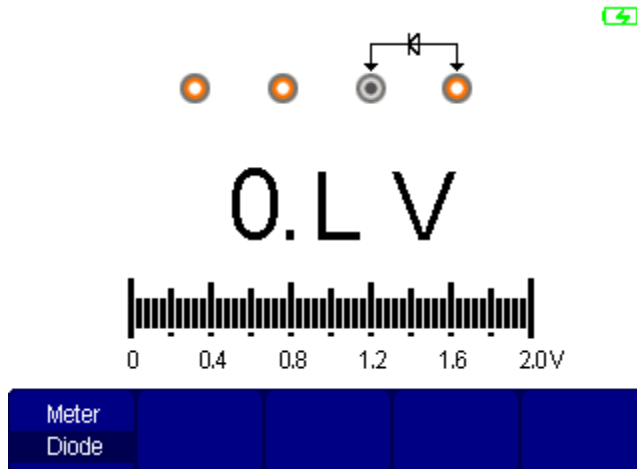

---

### WARNING:

Fully discharge the capacitor before connecting it to any of the inputs or it may damage the instrument.

---

---

### CAUTION:

Always connect the test leads to the instrument inputs first before connecting the DUT to avoid potential shock hazard.

---

Follow these steps to make a measurement.

1. Connect the black test lead to the **COM** input.
2. Connect the red test lead to the **V.Ω.C** input.
3. Probe with the test leads to the DUT and take the measured reading on display.



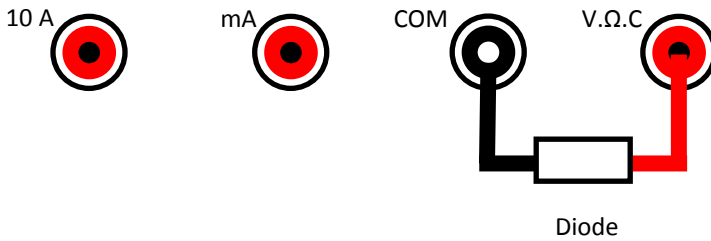

Figure 67 - Connection for Diode Measurement

**WARNING:**

Do not apply more than 1000 VDC across the terminals or they will be damaged.

## 4.5 Continuity Test

The instrument can test continuity.

Press  repeatedly until **Meter** is set to **Continuity**.

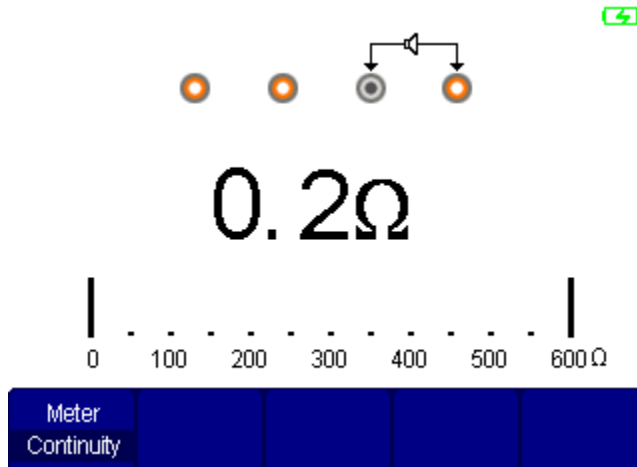

Figure 68 - Continuity Test

---

**WARNING:**

Fully discharge the capacitor before connecting it to any of the inputs or it may damage the instrument.

---

**CAUTION:**

Always connect the test leads to the instrument inputs first before connecting the DUT to avoid potential shock hazard.

---

To setup for continuity testing, do the following:

1. Connect the black test lead to the **COM** input.
2. Connect the red test lead to the **V.Ω.C** input.
3. Connect the two leads together to verify that the continuity function is working properly. The instrument should have a continuous beep sound.
4. Probe with the test leads to the DUT and take the measured reading on display.
5. If continuity is good, it will have a continuous beep sound.

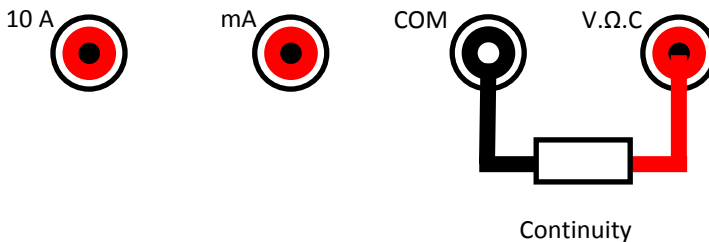

Figure 69 - Connection for Continuity Test

---

**WARNING:**

Do not apply more than 1000 VDC across the terminals or they will be damaged.

---

## 4.6 Make Capacitance Measurements

To measure capacitance, press **F1** repeatedly until **Meter** is set to “Cap.”.

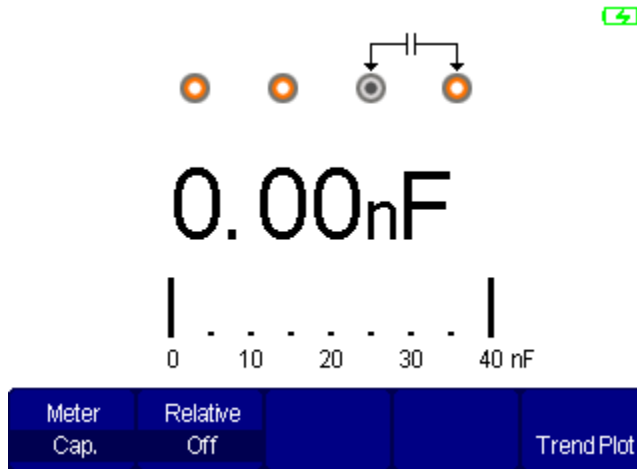

Figure 70 - Capacitance Measurement

Table 46 – Capacitance Measurement Menu

Menu Option	Setting	Description
Relative	On	Save the current input value as a reference value. Subsequent measurements will be the difference from the reference value. This is same as “zeroing” the meter.
	Off	Relative mode is disabled.
	Trend Plot	Enters the <b>Meter Trend plot</b> mode (See “Meter Trend Plot” for more information).

Configure relative settings from the menu.

---

### WARNING:

**Fully discharge the capacitor before connecting it to any of the inputs or it may damage the instrument.**

---

---

**CAUTION:**

**Always connect the test leads to the instrument inputs first before connecting the DUT to avoid potential shock hazard.**

---

**NOTE:**

**The capacitance measurement function is used for measuring general purpose electrolytic capacitors.**

---

Follow these steps to make a capacitance measurement.

4. Connect the black test lead to the **COM** input. This will connect to the negative side of your capacitor.
5. Connect the red test lead to the **V.Ω.C** input. This will connect to the positive side of your capacitor.
6. Probe with the test leads to the DUT and take the measured reading on display.

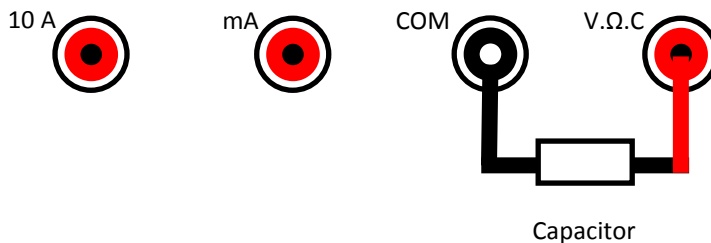

Figure 71 - Connection for Capacitance Measurement

---

**WARNING:**

**Do not apply more than 1000 VDC across the terminals or they will be damaged.**

---

## 4.7 Using Trend Plot

The trend plot function is available for some of the multimeter measurement functions. For details on using trend plot, refer to “Meter Trend Plot” in the following chapter.

## 5 Using the Recorder

There are three categories under the recorder function: Scope Trend Plot, Scope Recorder, and Meter Trend Plot.

The following sections will describe each of these functions in detail.

To enter the **Recorder** menu, press the  button.



### Scope Trend Plot

Scope Trend Plot allows storing two types of measurement data from the oscilloscope's channel input signals and plotting it to a graph. The data can be stored into external memory using a USB flash drive connected to the USB host port.

---

**NOTE:**



**The oscilloscope cannot be in SCAN mode when using scope trend plot. Before selecting the scope trend plot function, check that the oscilloscope is not in SCAN mode which will be indicated at the top left of the display.**

**Scan mode is automatically enabled for timebase set between 100 ms to 50 s.**

---

---

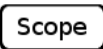
**NOTE:**

**When in scope trend plot mode, only the function keys and the mode keys (, , ) are active.**

---

From the **Recorder** menu, press F1 to select **Scope Trend Plot**. The scope trend plot screen and menu will be displayed.

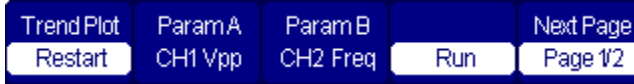

**Table 47 - Scope Trend Plot Menu 1/2**

Menu Option	Setting	Description
<b>Trend Plot</b>	Restart	Clear current data plot and restart recording.
<b>Parameter A/B</b>	Choose the parameter to be measured.	Voltage , time and delay measurement
	Run Stop	Continue or Stop recording data.
<b>Next Page</b>	Page 1/2	Enter the second page of the <b>Scope Trend Plot</b> menu.



**Table 48 - Scope Trend Plot Menu 2/2**

Menu Option	Setting	Description
	Normal	Display the data up to the minute.
	View all	Display all data on display.
<b>Manual</b>	Off	Record data automatically
	On	Record data manually. Pressing <span style="border: 1px solid black; padding: 2px;">Recorder</span> each time will record one measurement.
<b>CSV</b>	CSV	Select to save data to external USB flash drive.
<b>Return</b>	Return	Exit the <b>Recorder</b> mode.
<b>Next Page</b>	Page 2/2	Return to the first page of the <b>Scope Trend Plot</b> menu.

## Record Data with Trend Plot

Follow these steps to record data using Scope Trend Plot.

1. Select the type of data you want to record.

Press  to select **Param A** option, and a submenu similar to the **Measure** menu will display.



2. Select between voltage, time, or delay measurement parameters.

Press  to choose from voltage measurement parameters.

Press  to choose from time measurement parameters.

Press  to choose from delay measurement parameters.

3. Select the source channel and type of measurement parameter you want to record.

For voltage measurement parameters, the menu and selections are the same as in "Table 37 - Voltage Measurement Parameters Menu".

For time measurement parameters, the menu and selections are the same as in "Table 38 - Time Measurement Parameters Menu".

For delay measurement parameters, the menu and selections are the same as in "Table 39 - Delay Measurement Parameters Menu".

4. After selecting, press  to select **Confirm**. This will take you back to the **Scope Trend Plot** menu. In the menu below **Param A**, it will now show the new measurement parameter for recording.

If you are recording a different measurement parameter than what was previously selected, a confirmation message will be displayed to ask if you want to clear all data that are temporarily stored in memory before recording the new measurement parameter. Press

to selection **NO** or press  to select **YES**. Selecting **NO** will cancel your changes and return to the **Scope Trend Plot** menu.

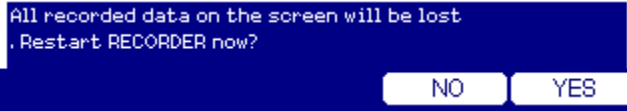

---

**NOTE:**

**If YES is selected, all data that has been recorded previously will be deleted, including all data in Param B.**

---

5. Follow steps 1-4 to select the second measurement parameter to record for **Param B** by pressing .

### ***Pause Recording***

By default, data is always recording continuously. To stop recording at any time, press  to toggle between **Run** or **Stop**.

### ***Restart Recording***

To restart recording the data from the beginning, press  to select **Restart**. The recording timer will reset back to 0:00:00 and all previously recorded data will be cleared from memory.

### ***Select Display Mode***

The display settings on the trend plot can be changed. Users can select viewing the data up to the minute, or select viewing all data in a compressed format.

To toggle between the two display modes, go to the second page of the **Scope Trend Plot** menu and press  to toggle between **Normal** and **View All**.



## ***Record Data by Manual Trigger***

By default, data is recorded automatically and continuously. To record data by a manual trigger, access the second page of the **Scope Trend Plot** menu and press  to **On** or **Off** the **Manual** option.

When set to **On**, the plot will stop recording. Instead, the  button will function as a manual trigger button. Each subsequent press will trigger one measurement recording to the plot (both **Param A** and **Param B**).

---

### **NOTE:**

In this mode, the  button will be used as a trigger instead of a means to enter the Recorder menu. To exit out of Scope Trend Plot, press  to select Return. All previously recorded data will be lost if you exit. A confirmation message will ask if you want to exit.

---

## ***Save Recorded Data to External Memory***

The recorded data on the scope trend plot is stored temporarily. All recorded data will be lost if the recording gets reset, exit out of the scope trend plot mode, or power OFF the instrument.

However, the data can be saved onto an external USB flash drive.

To save:

1. Go to the second page of the **Scope Trend Plot** menu and select **CSV** by pressing .
2. The **Directory** menu will be displayed.

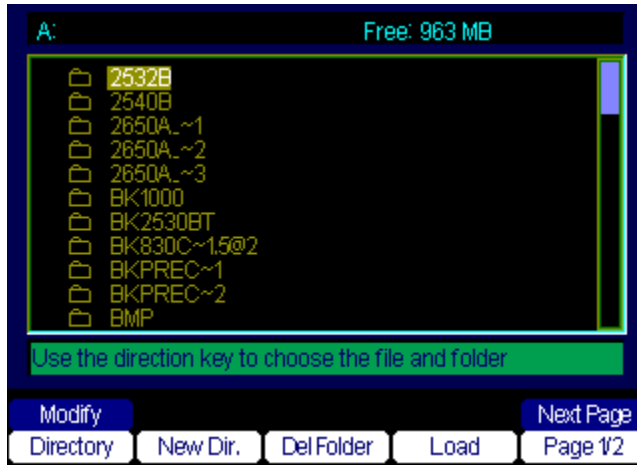

3. Follow the same instructions from section “3.7 Save/Recall Function” to create a directory and/or a new file, then select **Load** from the menu to save all recorded data into a new file on the external USB flash drive.

---

**NOTE:**

**Depending on the amount of data recorded, the saving process may take a while. Please wait and do not interrupt the instrument while it is saving data. When finished, a message will prompt to notify the file has been saved successfully.**

---

To exit out of the **Directory** menu, go to the second page and select **Return**.

## Scope Recorder

The scope recorder allows users to record the oscilloscope’s channel input signals for a long period of time. This function is available when the scope is configured with slower timebase settings.

The recorded waveforms can be temporarily saved to and played back on the instrument. It can also be saved into an external USB flash drive.

---

**NOTE:**

**The Scope Recorder function is only available when the oscilloscope is in SCAN mode. SCAN mode is automatically enabled when the oscilloscope timebase is set between 100 ms to 50 s.**

---

Before entering the **Scope Recorder** menu, verify that the oscilloscope is operating in SCAN mode. Press **Scope** to enter the oscilloscope operation mode and set SCAN mode. **SCAN mode is available only for timebase 100 ms to 50 s.**

From the **Recorder** menu, press **F2** to select **Scope Recorder**. The scope record screen and menu will be displayed.



**Table 49 - Scope Recorder Menu**

Menu Option	Description
Record	Select record options
Replay	Replay the recorded waveform.
Option	Setup the parameters of waveform recorder.
Return	Exit scope recorder function.



**Table 50 - Record Options Menu**

Menu Option	Setting	Description
	Start	Begin recording CH1 and/or CH2 waveforms.
	Replay	Select to replay the recorded waveform.

	Copy	Copy recording saved in internal memory to external USB flash drive.
<b>Save mode</b>	Memory	Copy recording to internal memory.
	USB Key	Copy recording to external USB.
	Return	Return to the <b>Scope Recorder</b> menu.



**Table 51 - Replay Option Menu**

Menu Option	Description
Stop/Continue	Pause or continue to play the recorded waveform in memory. Timebase can be changed to view the waveform in more detail.
Restart	Replay the waveform
Previous	View the previous section of the recorded waveform.
Next	View the next section of the recorded waveform.
Return	Return to the <b>Scope Recorder</b> menu.



**Table 52 - Option Menu**

Menu Option	Setting	Description
<b>Viewer</b>	Full screen	Record and replay channel waveform with full screen.
	Split	Record and replay channel waveform with a split screen. The top half will display CH1 and the bottom half will display CH2.
<b>Record</b>	continuous	Continuously record data. When memory is full, the oldest data will be overwritten.
	Single	Stop recording data when memory is full.
<b>Replay</b>	By Point	When replaying, the screen waveform updates every dot from left to right.

	By frame	When replaying, the screen waveform updates the whole screen according to the time of sampling every frame of data.
	Return	Return to the <b>Scope Recorder</b> menu.

### **Configure Record Options**

Press **F3** from the **Scope Recorder** menu to select **Options**.

Press **F1** to set the **Viewer** for **Full Screen** or **Split** view. Then, set **Record** to **continuous** or **Single** by pressing **F2**.

### **Start Scope Recording**

To enable scope recording, press **F1** from the **Scope Recorder** menu to select **Record**. Then, setup **Save Mode** to select where you want to store the recording.

If **USB key** is selected for **Save Mode**, **File Name** will be shown in the menu with a file name starting with **BKXXXXX** where **XXXXX** will be an auto increment number starting with 00001. If no external USB flash drive is detected, **File Name** will indicate **No U disk**.

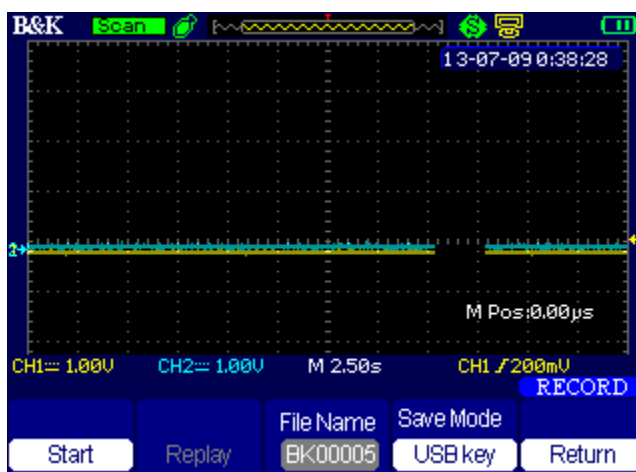

**Figure 72 - Scope Recorder External Save Mode**

Press  to select **Start**. The instrument will start scope recording.

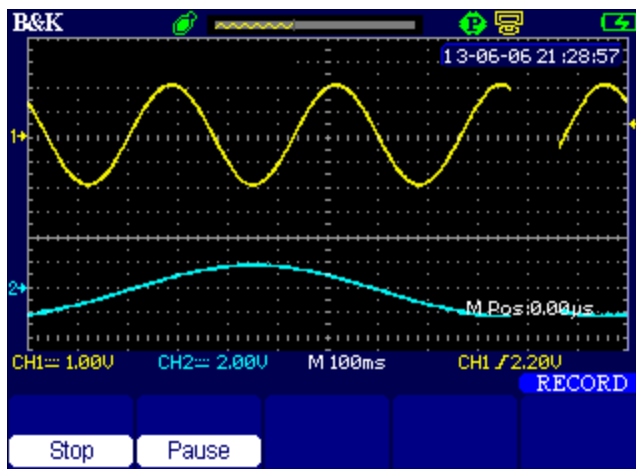

Figure 73 - Recording Display

The top left will indicate the record time, which tracks the time length of the recording. The remaining time is also indicated to track how much longer the instrument can record before memory is full.

To stop recording at any time, press  to select **Stop**.

To pause the recording at any time, press  to select **Pause**. While the recording is paused, the  menu option will change to **Continue**. Press it to continue recording.

### ***Playback Scope Recording***

To playback the recorded waveforms, from the **Scope Recorder** menu, press  to select **Record**. Then press  to select **Replay**. The waveform will begin to replay on the display.

Alternatively, you can go to the **Replay** menu by pressing  from the **Scope Recorder** menu, then press  again to select **Restart** to begin playback.

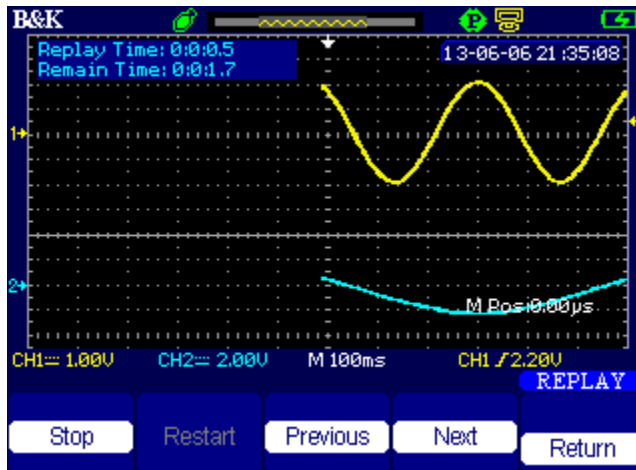

Figure 74 - Playback Scope Recording

To stop playback at any time, press  to select **Stop**.

When the replay is finished, a message will say “This is the end of the waveform”.

To view different portions of the recording, use the **Previous** and **Next** menu options by pressing  or  respectively to go backward or forward.

To replay it again after playback is finished, select **Restart** by pressing .

To playback a file saved to an external USB flash drive, press  from the recorder menu to select **File Name** and the file directory screen will be

displayed. Select the file you want to playback by using the  or

 arrow, then press  to select **Load**. You will then go back to the **Scope Recorder** menu. Press  to select **Replay** to playback the selected file.

## Meter Trend Plot

Meter Trend Plot allows storing of measurement data and plotting it into a graph when in multimeter mode. The data can be stored into external memory using a USB flash drive connected to the USB host port.

To enable this function, there are two ways.

1. Press the **Meter** button from the front panel to enter the multimeter mode. Then select **Trend Plot** by pressing **F5**.
2. Press the **Recorder** button and select **Meter Trend Plot** by pressing **F3**.

---

### NOTE:

**The measurement function (i.e. DCV, ACV, Diode, etc.) that the meter trend plot will store and plot depends on the function configured within the multimeter mode. Therefore, it is important to set up the multimeter first with the measurement function you want to use with trend plot.**

---

By default, the trend plot will continuously store and plot data when you enter the **Meter Trend Plot** menu.



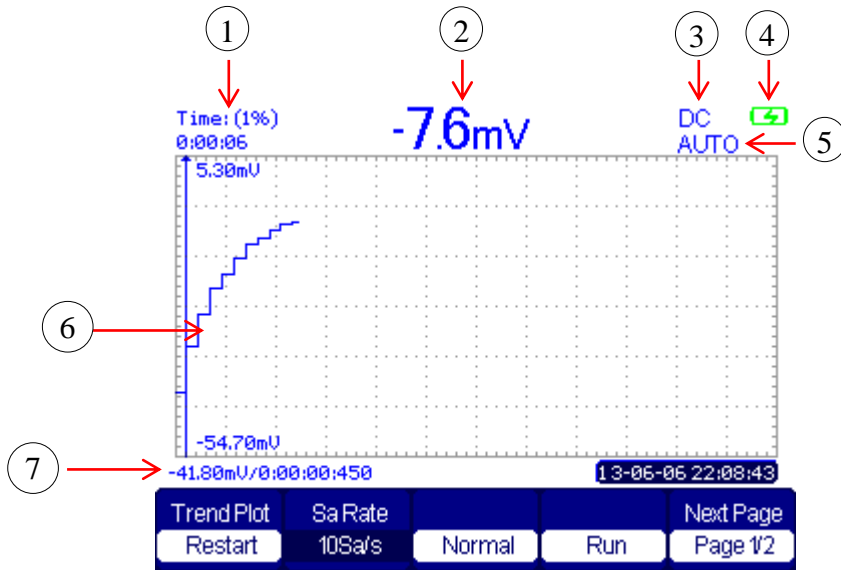

Figure 75 - Meter Trend Plot Display

①	Recording/Trend Plot time and percentage of temporary storage memory used.
②	Measured data value
③	Measurement function
④	Battery indicator
⑤	Range mode indicator
⑥	Measured data plot
⑦	Current measured value and time

Trend Plot	Sa Rate			Next Page
Restart	10Sa/s	Normal	Run	Page 1/2

Table 53 - Meter Trend Plot Menu 1/2

Menu Option	Setting	Description
Trend Plot	Restart	Restart the trend plot recording.
Sa Rate	10Sa/s, 5Sa/s, 2Sa/s, 1Sa/s, 0.5Sa/s, 0.2Sa/s	Set the sampling rate of the trend plot recording.
	Normal	Display the trend plot recorded data up to the minute.
	View All	Display all trend plot recorded data.
	Run	Record data automatically.
	Stop	Stop recording data.
Next Page	Page1/2	Enter the second page of the <b>Meter Trend Plot</b> menu.



Table 54 - Meter Trend Plot Menu 2/2

Menu Option	Setting	Description
CSV		Select to save recorded data onto external USB flash memory.
Manual	Off	Record data automatically.
	On	Record data manually. Pressing  each time will record one measurement.
	Return	Instrument will return to the multimeter mode.
Next Page	Page2/2	Return to the first page of the <b>Meter Trend Plot</b> menu.

## ***Record Data with Trend Plot***

Follow these steps to record data using Meter Trend Plot.

1. Select the multimeter measurement function you want to record.

Press  to enter the multimeter mode. Then configure the multimeter for the function you want to measure (follow instructions from chapter 4 “Using the Digital Multimeter”).

2. Select the sampling rate at which you want to record and plot the measurement data.

Press  to toggle the available sampling rate. 10 Sa/s is the maximum and 0.2 Sa/s is the minimum rate.

## ***Pause Recording***

By default, data is always recording continuously. To stop recording at any time, press  to toggle between **Run** and **Stop**.

## ***Restart Recording***

To restart recording the data from the beginning, press  to select **Restart**. The recording timer will reset back to 0:00:00 and all previously recorded data will be cleared from memory.

## ***Select Display Mode***

The display settings on the trend plot can be changed. Users can select viewing the data up to the minute, or select viewing all data in a compressed format.

To toggle between the two display modes, toggle  to select between **Normal** and **View All**.

## ***Record Data by Manual Trigger***

By default, data is recorded automatically and continuously. To record data by a manual trigger, go to the second page of the **Meter Trend Plot** menu and press  to set the **Manual** option **On** or **Off**.

When set to **On**, the plot will stop recording. Instead, the  button will function as a manual trigger button. Each subsequent press will trigger one measurement recording to the plot.

---

### **NOTE:**

In this mode, the  button will be used as a trigger instead of entering the Recorder menu. To exit out of Meter Trend Plot, press  to select Return in the second page of Meter Trend Plot menu. All previously recorded data will be lost if you exit. A confirmation message will ask if you want to exit.

---

## ***Save Recorded Data to External Memory***

The recorded data on the meter trend plot is stored temporarily. All recorded data will be lost if the recording gets reset, exit out of the meter trend plot mode, or power OFF the instrument.

However, the data can be saved onto an external USB flash drive.

To save:

1. Go to the second page of the **Meter Trend Plot** menu and select **CSV** by pressing .
2. The **Directory** menu will be displayed.

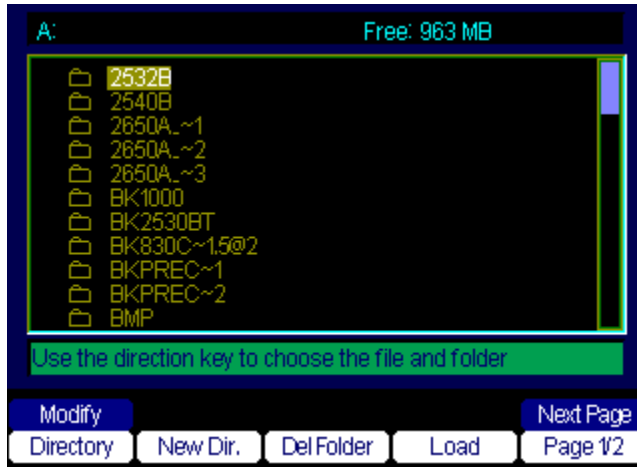

3. Follow the same instructions from section 3.7 “Save/Recall Function” to create a directory and/or new file, then select **Load** from the menu to save all recorded data into a new file on the external USB flash drive.

---

**NOTE:**

**Depending on the amount of data recorded, the saving process may take a while. Please wait and do not interrupt the instrument while it’s saving. When finished, a message will be displayed to notify the file has been saved successfully.**

---

To exit out of the **Directory** menu, go to the second page and select **Return**.

## 6 Remote Communication

The 2510 series digital storage oscilloscope comes with application software which provides most of the controls that emulate the front panel of the instrument. The miniUSB device port on the side of the instrument, when not used for probe compensation, can be used to connect to a computer using a miniUSB to USB type A cable and allow remote communication via the software.

The software is free and can be downloaded at [www.bkprecision.com](http://www.bkprecision.com)

Remote communication is supported using the software only. Remote commands are not available.

# 7 Troubleshooting Guide

## System Message Prompts and Instructions

- **Trig level at limit!**  
The trigger level is at the limit when you adjust the trigger level.
- **Horizon position at limit!**  
The horizontal position is at the limit when adjust the horizontal position keys.
- **Volts/Div at limit!**  
The vertical voltage scale has reached the Minimum 5mV/div or the Maximum 100V/div.
- **Volts position at limit!**  
The vertical position is at the limit when adjusting the vertical position keys.
- **Sec/Div at limit!**  
The Volts/Div is at maximum range while turning the vertical scale keys.
- **Holdoff time at limit!**  
The holdoff time is set to the maximum or minimum value.
- **Function isn't useable!**  
The selected function cannot be used with the current setup.
- **No signal!**  
Signal could not be found using the  key.
- **Adjust at limit!**  
Pulse width has reached the limit (Min 20.0 ns or max 10.0 s).
- **Location Empty!**  
If you have no stored waveforms or setups on the selected location, the screen will display this information when you press the "Recall" button on this location.
- **USB Flash Drive Plug In!**  
A USB flash drive is detected and connected to the USB Host port.
- **USB Flash Drive Pull Out!**  
A USB flash drive has been removed.
- **Store Data Success!**

File successfully saved.

- **Ready Data Success!**  
Setup data or waveform data from the internal storage of the oscilloscope or USB flash drive was read successfully.
- **Record Wave Success!**  
This message will appear when you finish recording waveforms.



## Frequency Asked Questions

### Oscilloscope

1. I pressed the auto button, but it says no signal. Is it malfunctioning?  
**The auto function does not work for all waveforms. Usually, waveforms that are periodic can be detected.**

2. How do I adjust the trigger level?

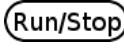

The  and  keys are used to adjust trigger level. However, if you select a menu option that has a  symbol, trigger level cannot be adjusted until you exit the menu or select a different menu option that does not require the use of the same keys as the trigger level adjust.

3. There is no **Single** button, how do I perform a single trigger capture?  
Press  to enter the Trigger menu, and set **Mode to Single**.  
Then, use  button to reset for each single capture.
4. How do I enter SCAN mode?  
**SCAN mode is available for timebase settings from 100 ms up to 50 s and is automatic. It is not available for timebase settings below 100 ms.**



## Multimeter

1. After I change a menu selection, how do I set the changes and close the menu window?

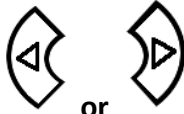

Press the **←** or **→** keys to set the menu changes and to close the menu window.

2. I cannot measure any current. Is there a problem?  
**There are 2 ports to measure current, one is labeled 10 A to measure current up to 10 A. The other is labeled mA, which is designed to only measure up to 600 mA. Both terminals have an internal protection fuse. If you are not getting any measurements from connecting to the correct port:**
  - a. Check that there is current flowing from your DUT.
  - b. Your meter may not be in the correct range to make the measurement. Change it to Auto range or change the range manually to one suitable for the measurement.
  - c. Fuse may be blown for the 10 A input.

## 8 Specifications

### Oscilloscope Specifications

All specifications apply to measurements with a 10X probe. To verify that the oscilloscope meets specifications, the oscilloscope must first meet the following conditions:

- The oscilloscope must have been operating continuously for 30 minutes within the specified operating temperature.
- If the operating temperature changes by more than 5° C, you must perform the Do Self Cal operation, accessible through the Utility menu.

All specifications are guaranteed unless noted “typical.”

Models	2511	2512	2515	2516
Bandwidth	60 MHz	100 MHz	60 MHz	100 MHz
Real Time Sampling Rate	1 GSa/s (half-channel interleaved) <sup>(1)(2)</sup> , 500 MSa/s (per channel)			
Channels	2 (non-isolated)		2 (isolated)	
Rise Time	< 5.8 ns	< 3.5 ns	< 5.8 ns	< 3.5 ns
Ch to Ch Isolation (Both channels in same V/div setting)	> 100:1 at 50 MHz			
Memory Depth	40 kpts (half-channel interleaved) <sup>(1)(2)</sup> , 20 kpts (per channel)			
Deep Memory <sup>(3)</sup>	2 Mpts (half-channel interleaved) <sup>(1)</sup> , 1 Mpts (per channel)			
Vertical Resolution	8 bits			
Vertical Sensitivity	2 mV/div – 100 V/div (1-2-5 order)		5 mV/div – 100 V/div (1-2-5 order)	
DC Gain Accuracy	5 mV/div-100 V/div: ≤ ± 3 %		5 mV/div-100 V/div: ≤ ± 3 %	

	2 mV/div: $\leq \pm 4\%$			
Max. BNC Input Voltage	CATII 300 V RMS from BNC signal to BNC shell			
Max. input Voltage for probe	<sup>(4)</sup> 1x/10x CATII 300 V RMS (PR150SA) <sup>(5)(6)</sup> 10x CATIII 600 V RMS, CATII 1000 V RMS (PR250SA)			
Channel Voltage Offset Range	2mV - 200mV : $\pm 1.6V$ 206mV - 10V : $\pm 40V$ 10.2V - 100V : $\pm 400V$		5mV - 200mV : $\pm 1.6V$ 206mV - 10V : $\pm 40V$ 10.2V - 100V : $\pm 400V$	
Bandwidth Limit	20MHz (-3dB)			
Horizontal Scan Range	5.0nS/div - 50S/div	2.5nS/div - 50S/div	5.0nS/div - 50S/div	2.5nS/div - 50S/div
Timebase Accuracy	$\pm 50$ ppm measured over 1 ms interval			
Input Coupling	AC, DC, GND			
Input Impedance	1 M $\Omega$ +/- 2 %    18 pF $\pm 3$ pF		1 M $\Omega$ +/- 2 %    16 pF $\pm 3$ pF	
Probe Attenuation Selectable Factors	1X, 5X, 10X, 50X, 100X, 500X, 1000X			
Vertical and Horizontal Zoom	Vertically or horizontally expand or compress a live or stopped waveform.			
I/O Interface				
USB	USB host port support USB flash drives (FAT format). USB device port for PC connectivity			
Acquisition Modes				
Sampling	Display sample data only			
Peak Detect	Capture the maximum and minimum values of a signal			
Average	Waveform averaged, selectable from 4, 16, 32, 64, 128, 256			
Trigger System				
Trigger Types	Edge, Pulse Width, Video*, Slope, Alternative  *Support signal Formats: PAL/SECAM, NTSC Trigger condition: odd field, even field, all lines, or line number			

Trigger Modes	Auto, Normal, Single
Trigger Coupling	AC, DC, LF reject, HF reject
Trigger Source	CH1, CH2
Trigger Level Range	CH1, CH2: $\pm 6$ divisions from center of display
Trigger Displacement	Pre-trigger: Memory depth/ 2* sampling Delay Trigger: 268.04 div
Pulse Width Trigger	Trigger Modes: Positive Pulse (>, <, =), Negative Pulse (>, <, =)
Slope Trigger	Positive slope (>, <, =), Negative slope (>, <, =) Time: 20 ns - 10 s
Alternate Trigger	CH1 trigger type: Edge, Pulse, Video, Slope CH2 trigger type: Edge, Pulse, Video, Slope
Hardware Frequency Counter	
Reading Resolution	1 Hz
Range	DC couple, 10 Hz to MAX bandwidth
Signal Types	Satisfying all trigger signals (except pulse width trigger and video trigger)
Waveform Math and Measure	
Math Operation	Add, Subtract, Multiply, Divide, FFT
FFT	Window mode: Hanning, Hamming, Blackman, Rectangular Sampling points: 1024
Measure	Vpp, Vmax, Vmin, Vamp, Vtop, Vbase, Vavg, Mean, Crms, Vrms, ROVShoot, FOVShoot, RPRESshoot, FPRESshoot, Rise, Fall, Freq, Prd, +Wid, -Wid, +Dut, -Dut, BWid, Phas, FRR, FRF, FFR, FFF, LRR, LRF, LFR, LFF
Cursors	
Types	Voltage, Time
Measurements	$\Delta V$ , $\Delta T$ , $1/\Delta T$ (frequency)
Display System	
Display	5.7" Color TFT, 320 x 234 resolution, 64K color
Display Contrast (Typical)	150:1
Backlight Intensity (Typical)	300 nits

Wave Display Range	8 x 12 div
Wave Display Mode	Dots, Vector
Persistence	Off, 1 sec, 2 sec, 5 sec, Infinite
Menu Display	2 sec, 5 sec, 10 sec, 20 sec, Infinite
Screen-Saver	Off, 1 min., 2 min., 5 min., 10 min., 15 min., 30 min., 1 hr, 2 hr, 5 hr
Waveform Interpolation	Sin(x)/x, Linear
Measure Display Modes	Main, Window zoom, Scan, X-Y
X-Y Sampling Frequency	Support 25 kSa/s - 250 MSa/s sampling rate (1-2.5-5 order)
Color Mode	Normal, Invert

(1) Half channel operation means that only Ch1 or Ch2 is active.

(2) When sampling rate is 1 GSa/s. For sampling rate  $\leq$  500 MSa/s, the maximum memory depth is 20 kpts.

(3) Available when sampling rate is  $<$  500 MSa/s and maximum data depth mode is enabled.

(4) Probe included with models 2511 and 2512 only.

(5) Probe included with models 2515 and 2516 only.

(6) Refer to the respective probe's manual for more information on the specification.

# Maximum Input Voltages

## Maximum Input Voltage vs. Frequency

The chart below shows the maximum input voltage vs. frequency.

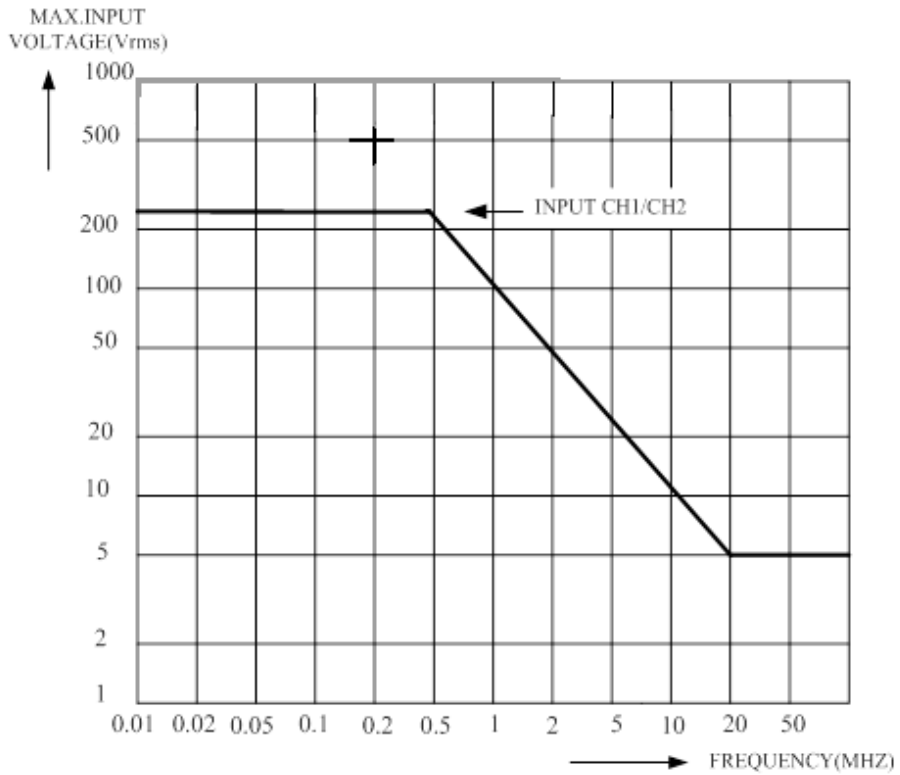

## Maximum Input Voltage between Scope Reference and Scope Reference to ground

The chart below shows the maximum input voltage between scope reference and scope reference to ground for models 2515 and 2516 only.

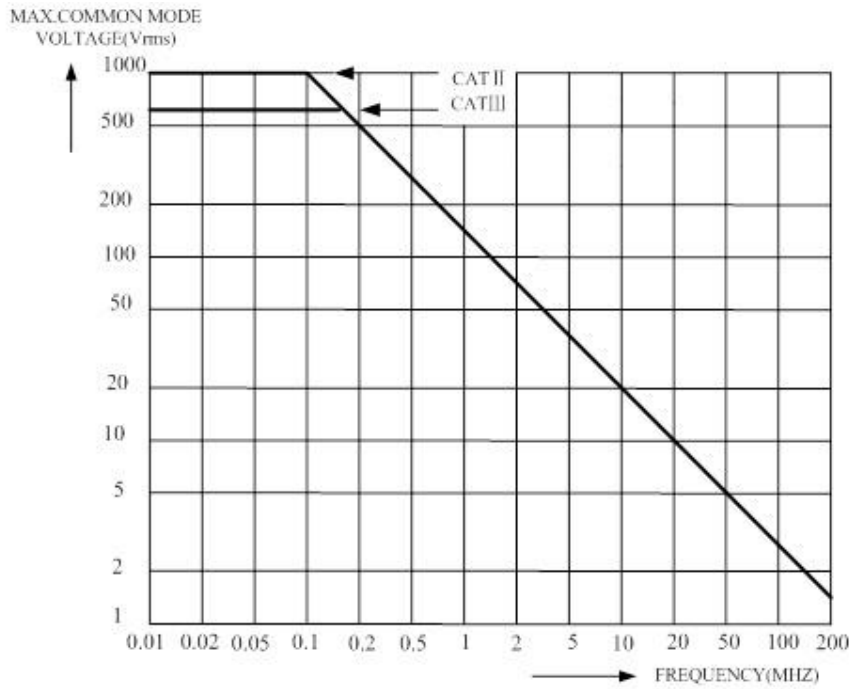

## Multimeter Specifications

- All specifications are based on operating at temperatures  $23 \pm 5^{\circ}\text{C}$  and relative humidity  $< 75\%$ .
- Accuracy is based on  $\pm$  (% of reading + offset)

<b>Display Resolution</b>	6000 counts
<b>Measurement Function</b>	DC voltage, AC voltage, resistance, diode, continuity, capacitance, DC current, AC current
<b>Max. Input Voltage</b>	AC: 750 V (30 Hz - 1 kHz) DC: 1000 V
<b>Max. Input Current</b>	AC: 10 A (30 Hz - 1 kHz) DC: 10 A
<b>Input Impedance</b>	10 M $\Omega$
<b>Max. Input Voltage between Multimeter input reference and ground</b>	CAT I, CAT II 600 V RMS CAT III 300 V RMS
<b>Max. input Voltage for Multimeter input ports</b>	Voltage/Resistance/Capacitance port: DC 1000 V, AC 750 V RMS Current port (mA): AC 250 V, 600 mA Current port (10A): AC 250 V, 10 A

DC Voltage		
Range	Resolution	Accuracy
60.00 mV	10 $\mu\text{V}$	$\pm$ (1 % + 5 digits)
600.0 mV	100 $\mu\text{V}$	
6.000 V	1 mV	
60.00 V	10 mV	
600.0 V	100 mV	
1000 V	1 V	



<b>(1)AC Voltage</b>		
<b>Range</b>	<b>Resolution</b>	<b>Accuracy</b>
60.00 mV	10 $\mu$ V	$\pm$ (1 % + 15 digits)
600.0 mV	100 $\mu$ V	$\pm$ (1 % + 5 digits)
6.000 V	1 mV	
60.00 V	10 mV	
600.0 V	100 mV	
750 V	1 V	

**1. For frequency range 30 Hz to 1 kHz.**

<b>Resistance</b>		
<b>Range</b>	<b>Resolution</b>	<b>Accuracy</b>
600.0 $\Omega$	0.1 $\Omega$	$\pm$ (1 % + 5 digits)
6.000 k $\Omega$	1 $\Omega$	
60.00 k $\Omega$	10 $\Omega$	
600.0 k $\Omega$	100 $\Omega$	
6.000 M $\Omega$	1 k $\Omega$	
60.00 M $\Omega$	10 k $\Omega$	$\pm$ (3 % + 5 digits)

<b>Diode and Continuity Measure</b>	
Diode	0 – 2 V
Continuity	< 50 $\Omega$ alarm

<b>Capacitance</b>		
<b>Range</b>	<b>Resolution</b>	<b>Accuracy</b>
40.00 nF	10 pF	$\pm$ (3 % + 10 digits) For > 5 nF
400.0 nF	100 pF	$\pm$ (4 % + 5 digits)
4.000 $\mu$ F	1 nF	
40.00 $\mu$ F	10 nF	
400.0 $\mu$ F	100 nF	

<b>(2)(3)DC and AC Current</b>		
<b>Range</b>	<b>Resolution</b>	<b>Accuracy</b>
60.00 mA	10 $\mu$ A	$\pm$ (1.5 % + 5 digits)
600.0 mA	100 $\mu$ A	
6.000 A	1 mA	$\pm$ (2.5 % + 5 digits)
10.00 A	10 mA	

**2. For 10 A terminal, > 6 A DC or AC rms for 10 seconds ON and 15 minutes OFF.**

**3. For AC current ranges, frequency is verified for 30 Hz to 1 kHz.**

## Recorder Specifications

<b>Scope Trend Plot</b>	
Display Mode	Full view, Normal
Record Length	800K points, > 24 hours
Number of Channels	2

<b>Multimeter Trend Plot</b>	
Display Mode	Full view, Normal
Record Length	1.2 M dots, > 24 hours
Number of Channels	1

<b>Scope Recorder</b>	
Display Mode	Full view, Normal
Max. Record Length	Single Channel: 7M points Dual Channel: 3.5 M points
Number of Channels	2
Maximum Record Size to External Storage	4GB, 3000 hours

## General Specifications

Environmental and Safety	
Temperature	Operating: 32 °F to 104 °F (0 °C to +40 °C) Not operating: -4 °F to 158 °F (-20 °C to +70 °C)
Humidity	Operating: 85% RH, 104 °F (40 °C), 24 hours
Altitude	Operating: 9,842.5 ft (3,000 m)
Electromagnetic Compatibility	EMC Directive 2004/108/EC, EN61326:2006
Safety	Low voltage directive 2006/95/EC, EN61010-1:2001
General	
Storage Memory	2 reference waveforms, 20 setups, 10 waveforms
AC adapter Power Requirements	Input: 100-240 VAC, 50/60 Hz Output: 9V DC, 4 A
Battery	5000 mAh, 7.4 VDC
Charge Time	Approx. 4 hrs
Dimensions (W x H x D)	6.42" x 10.21" x 2.10" (163.2 x 259.5 x 53.3 mm)
Weight	Approx. 3.4 lbs (1.54 kg) including battery

# 11 Maintenance

Do not expose the LCD display to direct sunlight for long periods of time.

To avoid damage to the instrument or probes, do not expose them to sprays, liquids, or solvents.

## Cleaning

If the instrument requires cleaning, disconnect it from all power sources and clean only with a mild detergent and water. Be sure the instrument is completely dry before reconnecting it to any power source.

To clean the exterior surface:

1. Remove loose dust on the outside of the instrument and probes with a lint-free cloth.
2. Use a soft cloth dampened with water to clean the instrument.

**Note: To avoid damaging the surface of the instrument and probes, do not use any chemically abrasive cleaning agents.**

# SERVICE INFORMATION

---

**Warranty Service:** Please go to the support and service section on our website [www.bkprecision.com](http://www.bkprecision.com) to obtain an RMA #. Return the product in the original packaging with proof of purchase to the address below. Clearly state on the RMA the performance problem and return any leads, probes, connectors and accessories that you are using with the device.

**Non-Warranty Service:** Please go to the support and service section on our website [www.bkprecision.com](http://www.bkprecision.com) to obtain an RMA #. Return the product in the original packaging to the address below. Clearly state on the RMA the performance problem and return any leads, probes, connectors and accessories that you are using with the device. Customers not on an open account must include payment in the form of a money order or credit card. For the most current repair charges please refer to the service and support section on our website.

Return all merchandise to B&K Precision Corp. with pre-paid shipping. The flat-rate repair charge for Non-Warranty Service does not include return shipping. Return shipping to locations in North America is included for Warranty Service. For overnight shipments and non-North American shipping fees please contact B&K Precision Corp.

B&K Precision Corp.  
22820 Savi Ranch Parkway  
Yorba Linda, CA 92887  
[www.bkprecision.com](http://www.bkprecision.com)  
714-921-9095

**Include with the returned instrument your complete return shipping address, contact name, phone number and description of problem.**

# LIMITED THREE-YEAR WARRANTY

---

B&K Precision Corp. warrants to the original purchaser that its products and the component parts thereof, will be free from defects in workmanship and materials for a period of **three years** from date of purchase.

B&K Precision Corp. will, without charge, repair or replace, at its option, defective product or component parts. Returned product must be accompanied by proof of the purchase date in the form of a sales receipt.

To help us better serve you, please complete the warranty registration for your new instrument via our website [www.bkprecision.com](http://www.bkprecision.com)

**Exclusions: This warranty does not apply in the event of misuse or abuse of the product or as a result of unauthorized alterations or repairs. The warranty is void if the serial number is altered, defaced or removed.**

B&K Precision Corp. shall not be liable for any consequential damages, including without limitation damages resulting from loss of use. Some states do not allow limitations of incidental or consequential damages. So the above limitation or exclusion may not apply to you.

This warranty gives you specific rights and you may have other rights, which vary from state-to-state.

B&K Precision Corp.  
22820 Savi Ranch Parkway  
Yorba Linda, CA 92887  
[www.bkprecision.com](http://www.bkprecision.com)  
714-921-9095



22820 Savi Ranch Parkway  
Yorba Linda, CA 92887  
[www.bkprecision.com](http://www.bkprecision.com)

© 2013 B&K Precision Corp.