

PROFITEST H+E BASE

Diagnostics Unit for Electric Charging Stations (Type 2 Connector Socket)

3-349-876-03
1/3.16



Opening the Instrument / Repairs

The instrument may only be opened by authorized, trained personnel in order to ensure flawless operation and to assure that the guarantee is not rendered null and void.

Even original replacement parts may only be installed by authorized, trained personnel.

If it can be ascertained that the instrument has been opened by unauthorized personnel, no guarantee claims can be honored by the manufacturer with regard to personal safety, measuring accuracy, compliance with applicable safety measures or any consequential damages.

Return and Environmentally Sound Disposal

The instrument is a category 9 product (monitoring and control instrument) in accordance with ElektroG (German electrical and electronic device law). This device is subject to the RoHS directive. Furthermore, we make reference to the fact that the current status in this regard can be accessed on the Internet at www.gossenmetrawatt.com by entering the search term WEEE.

We identify our electrical and electronic devices in accordance with WEEE 2012/19/EU and ElektroG using the symbol shown at the right per DIN EN 50419.



These devices may not be disposed of with the trash.

Please contact our service department regarding the return of old devices (see address on back cover).

If the **batteries** used in your instrument or accessory product are depleted, they must be disposed of properly in accordance with valid national regulations.

Batteries may contain pollutants and heavy metals such as lead (Pb), cadmium (Cd) and mercury (Hg).

The symbol at the right indicates that batteries must not be disposed of with the trash, and must be brought to a designated collection point.



Table of Contents

General Notes	1
Explanation of Symbols.....	1
Basic Safety Precautions	2
Product Overview.....	3
Initial Start-Up.....	9
Diagnosis of Charging Points with the Diagnostics Unit	10
Language Selection	13
Errors.....	14
Maintenance	14
Technical Data.....	14
Appendix: Practical Information on Testing Charging Points	15

General Notes

These operating instructions include important information about your device's features and its use. Before using the device, read the instructions carefully and familiarize yourself with its operation. Keep these operating instruction in a safe place.

Explanation of Symbols



This product fulfills guidelines in accordance with 89/336/EEC.



Warning regarding **property damage**. Safety precautions must be adhered to.



Warning regarding **personal injury**. Safety precautions must be adhered to.

Basic Safety Precautions

Guarantee

No guarantee is made with regard to function and safety unless the warnings and safety precautions included in these operating instructions are observed.

GMC-I Messtechnik GmbH assumes no liability for personal injury or property damage which occurs due to non-observance of the warnings and safety precautions.

Use for Intended Purpose

The diagnostics unit is intended exclusively for examining the functional performance of charging stations for electric vehicles with type 2 connector socket (mode 3 charging). Use for other purposes is prohibited.

Target Group

Only trained, qualified electricians may use the PROFITEST H+E BASE diagnostics unit.

Trained, qualified electricians fulfill the following requirements:

- Knowledge of general and specific accident prevention regulations
- Knowledge of applicable electrotechnical regulations
- Training in use and care of appropriate safety equipment
- Ability to recognize hazards associated with electricity



Warning!



Danger!

The diagnostics unit may only be used at charging points which are tested in accordance with VDE 0100.

The unit is intended solely for the purpose of diagnostics and **cannot** be used as a substitute for a corresponding test instrument!

Product Overview

Scope of Delivery

- PROFITEST H+E BASE diagnostics unit
- Two 9 V block batteries
- 12 V power pack
- Operating instructions

Device Layout

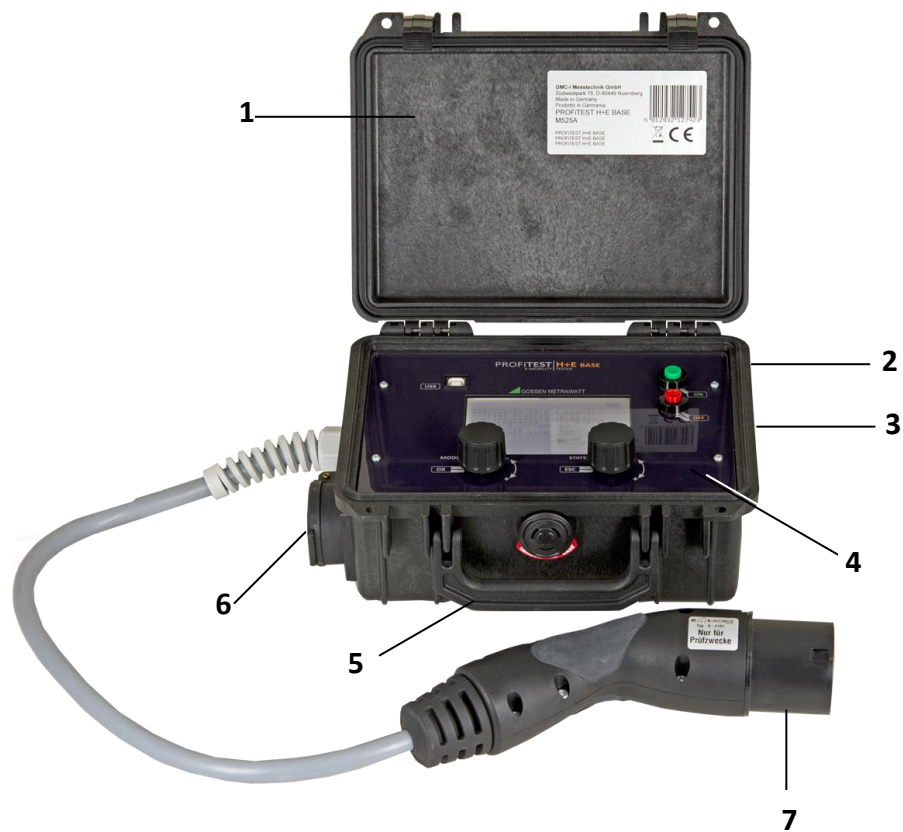

Key

- 1 Protective cover
- 2 Power pack connector socket (12 V, 1 A)
- 3 Battery compartment for two 9 V block batteries
- 4 Control panel
- 5 Carrying handle
- 6 230 V earthing contact socket for connecting a test consumer
- 7 Type 2 charging plug for connection to the charging point

Control Panel Layout

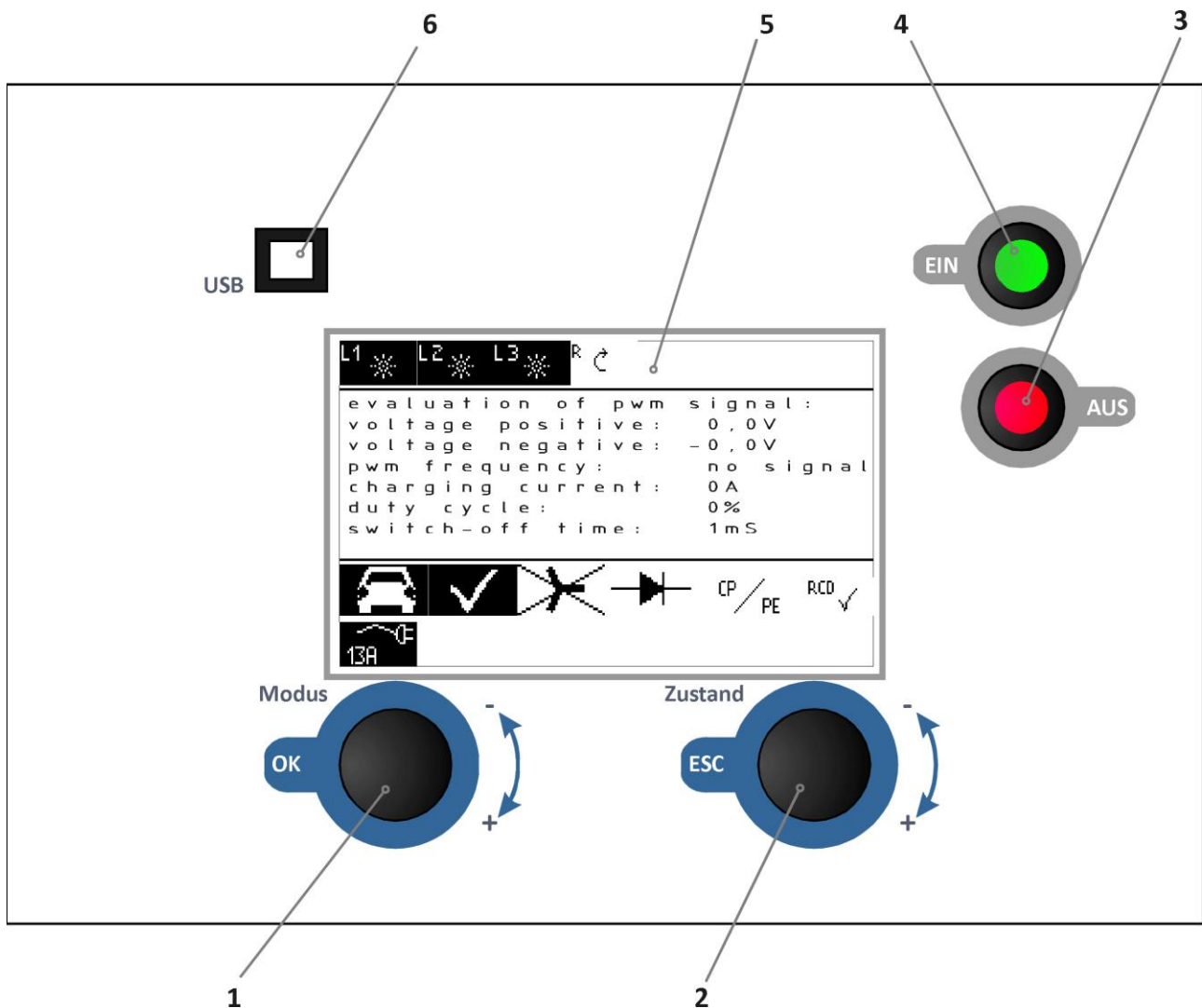

Key

- 1 Rotary mode selector switch and OK button
- 2 Rotary status selector switch and escape button
- 3 Off button
- 4 On button (the button has to be pressed and held for several seconds in order to switch the unit on)
- 5 Display
- 6 USB port

Display Layout

The display is subdivided into various blocks:

1 Vehicle States

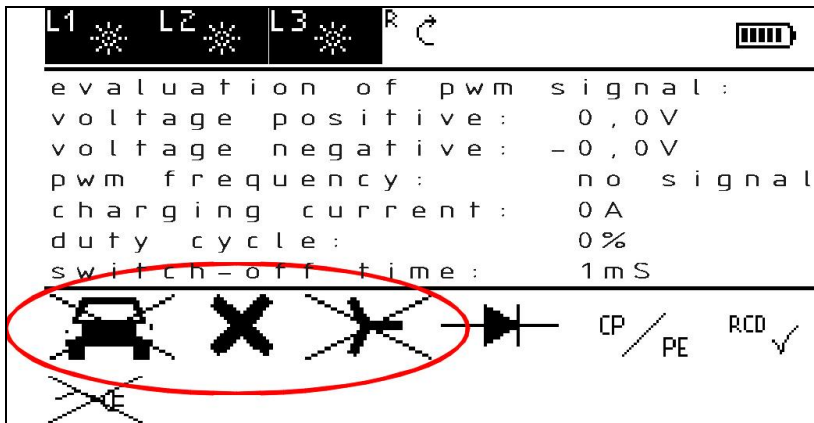

2 Cable Condition

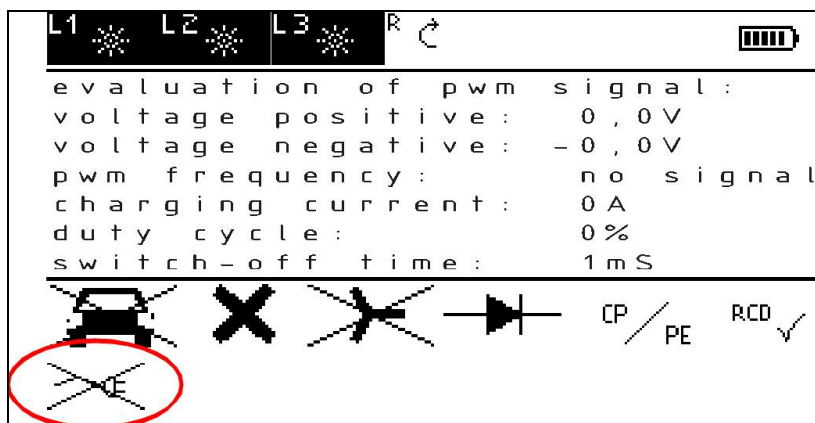

3 Error States

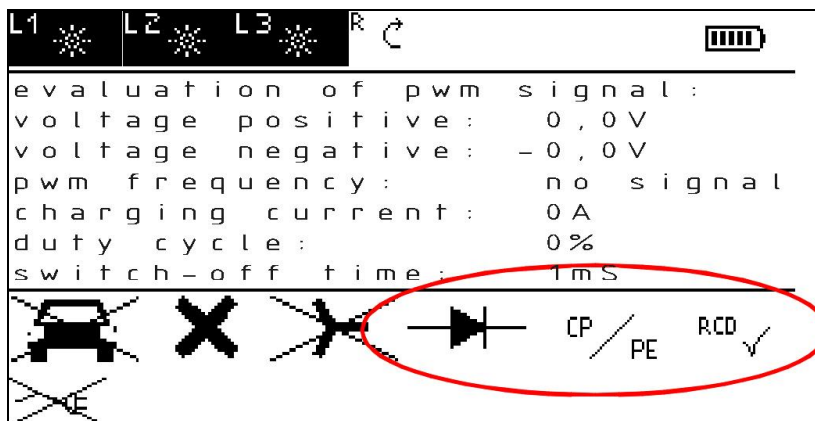

4 PWM Signal Evaluation

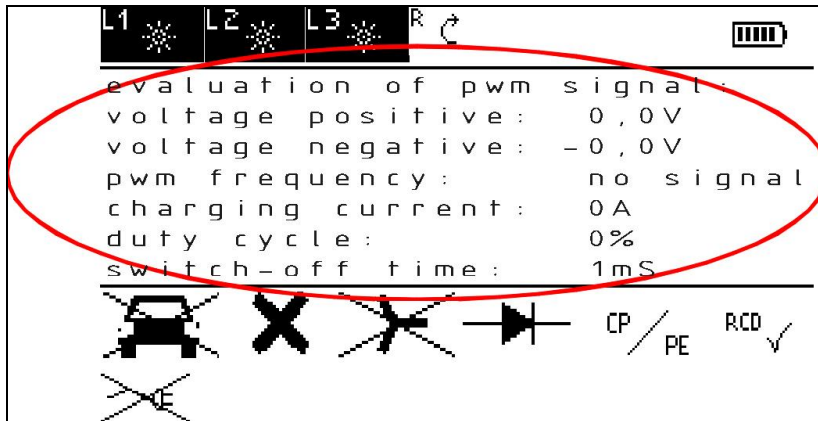

5 Phases and Phase Sequence

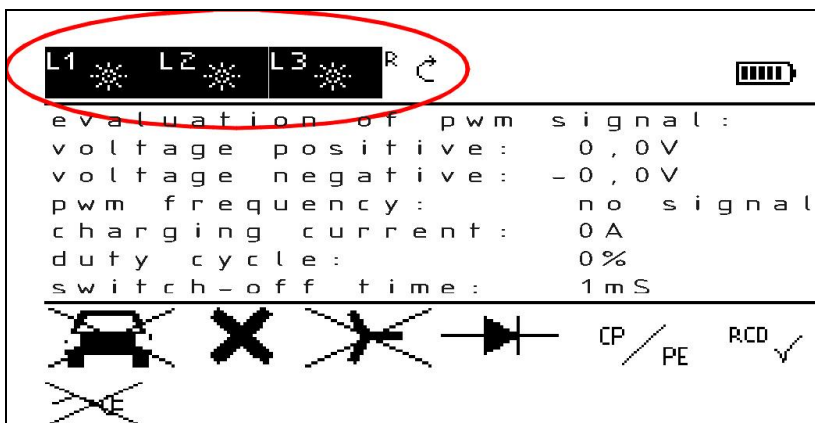

6 Battery Level

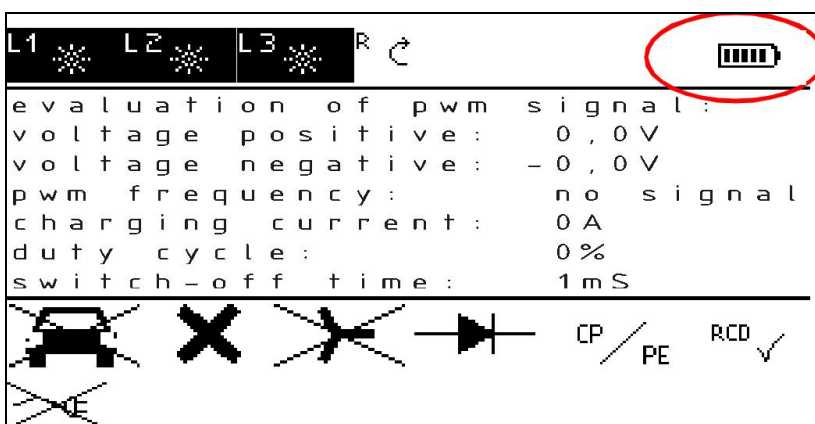

Displays

The following symbols with the meanings shown below can appear at the display:

Vehicle States



No vehicle connected



Vehicle connected



Vehicle not ready



Vehicle ready to charge



No ventilation required



Ventilation required

Cable Condition



No cable



13 A cable



20 A cable



32 A cable



63 A cable

Error States



Diode OK



Diode short-circuited



CP OK



CP short-circuited to PE



No RCD tripping



RCD tripping

Phases and Phase Sequence



Phase L1 switched on



Phase L2 switched on



Phase L3 switched on



Clockwise phase sequence



Counterclockwise phase sequence

Battery Level



Battery full



Battery depleted

Initial Start-Up

General



Warning!



Danger!

The device should be checked to assure that it's in good condition before initial start-up.
The device may only be used by trained personnel.

Inserting the Batteries

The device can be operated with two rechargeable or regular 9 V block batteries. The two battery compartments (3) on the right side of the device are opened in order to insert the batteries. Battery polarity is identified in the battery compartment.



Warning!

It is absolutely essential to assure that battery polarity is not reversed.

The battery compartments are closed after the batteries have been inserted.
Only high quality regular or rechargeable batteries should be used!

Connecting the Power Pack

A 12 V power pack is included in scope of delivery of the diagnostics unit. The device can be operated with either batteries or the power pack.

The power pack is connected by inserting its plug into the socket (2) at the right side of the device. The batteries are disconnected from supply power when the power pack is connected.



Warning!

Use only the included power pack in order to avoid damage to the diagnostics unit!

Switching the Diagnostics Unit On

The on button (4) is pressed and held for about 4 seconds in order to switch the diagnostics unit on. A start-up message appears. As soon as the start-up message is replaced with the normal display (see page 5), the on button (4) can be released.

Switching the Diagnostics Unit Off

Briefly press the off button (3) in order to switch the device off.

The device is switched off after about 10 minutes if neither of the rotary switches (1 and 2) has been activated during this time. Display illumination is switched off after just 30 seconds.

Connecting a Test Consumer

The diagnostics unit is equipped with an earthing contact socket (6) to which a test consumer can be connected. Any desired test consumer (230 V, max. 13 A) can be connected in order to test a charging point under load.

Connecting the Diagnostics Unit to a Charging Point

The diagnostics unit is equipped with a type 2 plug (7) for connection to the charging point. This can be plugged into the charging point.





Diagnosis of Charging Points with the Diagnostics Unit

Charging points can be tested in accordance with IEC 61851 with the help of the PROFITEST H+E BASE diagnostics unit.

The diagnostics unit makes the following functions available:

Vehicle Simulation (CP)

States A, B, C and D can be simulated in accordance with IEC 61851. Symbols corresponding to the various vehicle states appear at the display (see pages 6 and 8).

Display	Status	Voltage U/L	Meaning
	A	+12 V ... -12 V	No vehicle
	B	+9 V ... -12 V	Vehicle connected
	C	+6 V ... -12 V	Ready without ventilation
	D	+3 V ... -12 V	Ready with ventilation

Cable Simulation (PP)

The various codings for charging cables with 13, 20, 32 and 63 A can be simulated. It's also possible to simulate the "no cable" state. (see pages 6 and 8)

The various charging cables are simulated by connecting different resistances between PP and PE. The following values are possible in accordance with IEC 61851:

Display	Resistance	Max. Permissible Current
	None	No cable

	1.5 kΩ	13 A
	680 Ω	20 A
	220 Ω	32 A
	100 Ω	63 A

Fault Simulation

The diagnostics unit is equipped with an option for simulating common errors (see pages 6 and 9).

These include:

Short-circuiting of the diode in the vehicle’s circuit

Short-circuit between CP and PE

Residual current between L1 and PE (via a 6.8 K resistor)

The charging point’s reaction can be observed after triggering the various errors.

Display	Simulated Error
	No error
	Short-circuited diode
	CP-PE short-circuit
	Residual current between L1 and PE

Evaluation of the PWM Signal

Evaluation of the PWM signal provides information concerning the functionality of PWM communication between the vehicle and the charging point. Correct charging is only possible with error-free communication. The following PWM signal data are displayed for the purpose of diagnostics (see page 7):

Positive voltage

State A, + 12 V, no vehicle

State B, + 9 V, vehicle connected

State C, + 6 V, vehicle ready for charging without ventilation

State D, + 3 V, vehicle ready for charging with ventilation

Negative voltage

In the event of correct functioning, voltage is - 12 V. If the diode is short-circuited (by means of simulation), negative voltage is the same as positive voltage (but with the opposite preceding sign).

PWM frequency

The valid PWM frequency should be 1000 Hz.

Charging current

Displayed charging current is calculated from the duty cycle (see explanation under duty cycle).

Duty cycle

In accordance with IEC 61851 the charging point communicates the maximum permissible charging current to the vehicle via the duty cycle. Charging current is calculated automatically by the diagnostics unit and displayed. The following table is specified by IEC 61851:

Duty Cycle	Maximum Charging Current or Meaning
< 3%	Charging not permissible
$3\% \leq \text{duty cycle} \leq 7\%$	Increased communication
$7\% \leq \text{duty cycle} \leq 8\%$	Charging not permissible
$8\% \leq \text{duty cycle} \leq 10\%$	6 A
$10\% \leq \text{duty cycle} \leq 85\%$	Max. charging current = (% duty cycle) * 0.6 A
$85\% \leq \text{duty cycle} \leq 96\%$	Max. charging current = (% duty cycle - 64) * 2.5 A
$96\% \leq \text{duty cycle} \leq 97\%$	80 A
Duty cycle > 97%	Charging not permissible

Turn-off time T-off

Turn-off time T-off is the time which elapses between triggering of a shutdown condition and interruption of all 3 phases. (Caution! Realistic values are only displayed for 3-phase charging.) Shutdown conditions represent a transition from state C or D to state A or B, as well as triggering of an error.

In accordance with IEC 61851, turn-off time must be less than 100 ms.

Phases and Phase Sequence

The symbols for the phases (see page 7) indicate whether or not phases L1, L2 and L3 are switched on. The respective symbols appear when the phases are switched on. As soon as all 3 phases are switched on, the direction of phase rotation is displayed (clockwise or counterclockwise).

Operating the Diagnostics Unit with the Rotary Switches

The two rotary switches (1 and 2) are used to operate the diagnostics unit.

The device is switched from one mode to the other by turning the rotary mode selector switch (1).

The respectively active mode is indicated by means of a blinking display.

As shown on page 6, there are 3 operating modes:

- Vehicle states
- Cable condition
- Error states

Within each operating mode, the respective state is selected by turning the rotary status selector switch (2).

The selection of error states with the rotary switch must also be subsequently acknowledged by pressing and holding the OK button (1) for about 4 seconds. An acoustic signal is generated when the error has been successfully triggered. The error state is then retained until it's cleared by turning the rotary status selector switch (2).

Battery Display

Adequate battery voltage is imperative for testing the PWM signal. For this reason the diagnostics unit is equipped with a simple battery voltage display.

The symbol indicates whether or not battery voltage is adequate for proper diagnosis.

As soon as "battery depleted" is indicated (see also page 9), diagnosis is no longer possible.

"Battery full" is indicated when the power pack is connected.

USB Port

The USB port is used to install firmware updates and (depending on software version) to transmit diagnostics results to a connected PC.



Warning!



Danger!

The USB port may **not** be connected to a PC or a notebook while a charging point is being diagnosed!

Language Selection

Upon shipment from the factory, the user interface language of the diagnostics unit is set to German. Additional languages are also available. The device must be switched off in order to select a different language.

In order to select a language, press and hold the escape button (2). Then simultaneously press and hold the on button (4). The currently selected language is then indicated at the display (5). The desired language can then be selected by turning the rotary mode selector switch (1) and acknowledged by pressing the OK button (1). The diagnostics unit is then restarted automatically with the selected language.

The selected language is retained until a different language is once again selected.

Errors

Error	Cause	Required Action
After being switched on, the device switches itself back off again.	On button not pressed long enough.	Press and hold the on button until the device remains on.
The device does not respond when the on button is pushed.	No batteries are installed or the batteries are depleted.	Install new batteries or use the power pack.
The device indicates incorrect values for PWM voltage.	Battery depleted	Observe the battery display and install new batteries if necessary.

Maintenance

Due to the device's characteristics, no maintenance should be carried out by the user. If repairs should become necessary, please contact our repair and replacement parts service department (see address on back cover).

Outside surfaces may only be cleaned with a dry, lint-free cloth.



Danger!

No liquids may be permitted to penetrate into the device's interior or the plug connectors.

Technical Data

Input voltage	400 V (3-phase)
Frequency	50 Hz
Test consumer power	Max. 2.9 kVA

Electrical Safety

Protection class	I
Nominal voltage	400 V DC
Test voltage	500 V DC
Measuring category	CAT III, 300 V
Pollution degree	2

Ambient Conditions

Operating temperature	-10 to 45 °C
Storage temperature	-25 to 60 °C
Relative humidity	Up to 80% (no condensation)

Mechanical Design

Dimensions (W x L x H)	200 x 240 x 115 mm
Weight	2.35 kg
Protection	IP 21

Appendix: Practical Information on Testing Charging Points

Type II Plug for Mode 3 Charging

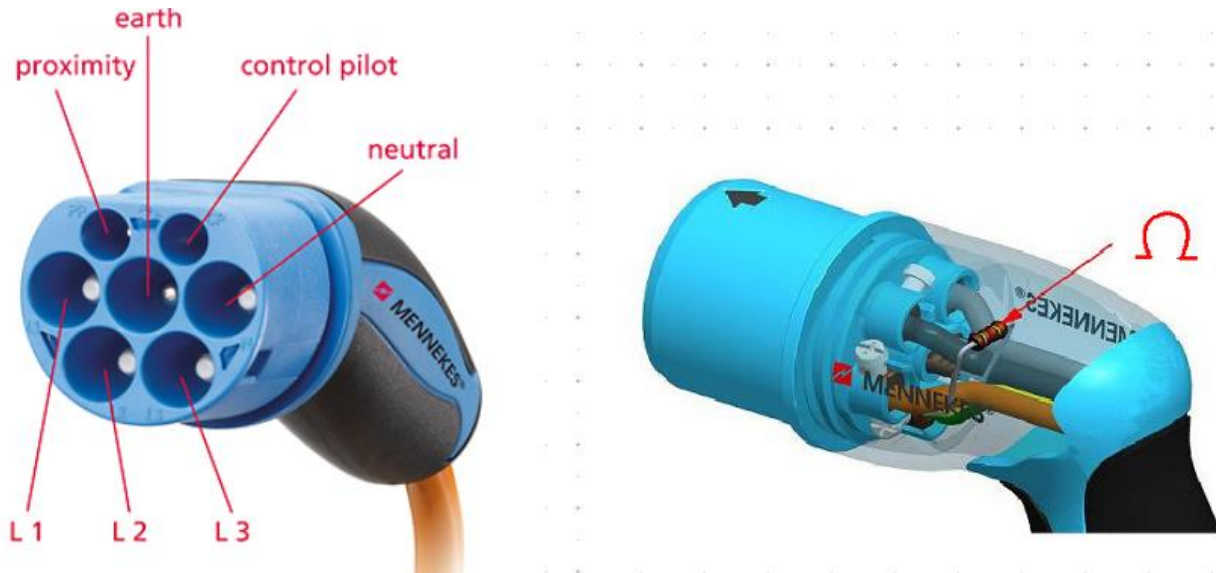

Source: Mennekes

Resistance Coding for Charging Cables

Table B.101 – Resistor Codings for Plugs

Current capacity of the cable assembly	Nominal resistance of Rc Tolerance $\pm 3\%$ ³	Recommended interpretation range by the EVSE
13 A	1.5 k Ω 0.5 W ^{1,2}	> 1 k Ω - 2.7 k Ω
20 A	680 Ω 0.5 W ^{1,2}	330 Ω - 1 k Ω
32 A	220 Ω 0.5 W ^{1,2}	150 Ω - 330 Ω
63 A (3-phase) / 70 A (1-phase)	100 Ω 0.5 W ^{1,2}	75 Ω - 150 Ω
Interrupt power supply		< 75 Ω

¹ The power dissipation of the resistor caused by the detection circuit shall not exceed the value given above. The value of the pull-up resistor shall be chosen accordingly.
² Upon circuit failure mode, resistors used should preferably fail such that the resistance value rises. Metal film resistors commonly show acceptable properties for this application
³ Tolerances to be maintained over the full useful life and under environmental conditions as specified by the manufacturer.

Source: IEC 61851

Typical Pilot Electric Equivalent Circuit for Mode 3 Charging

Typical pilot electric equivalent circuit

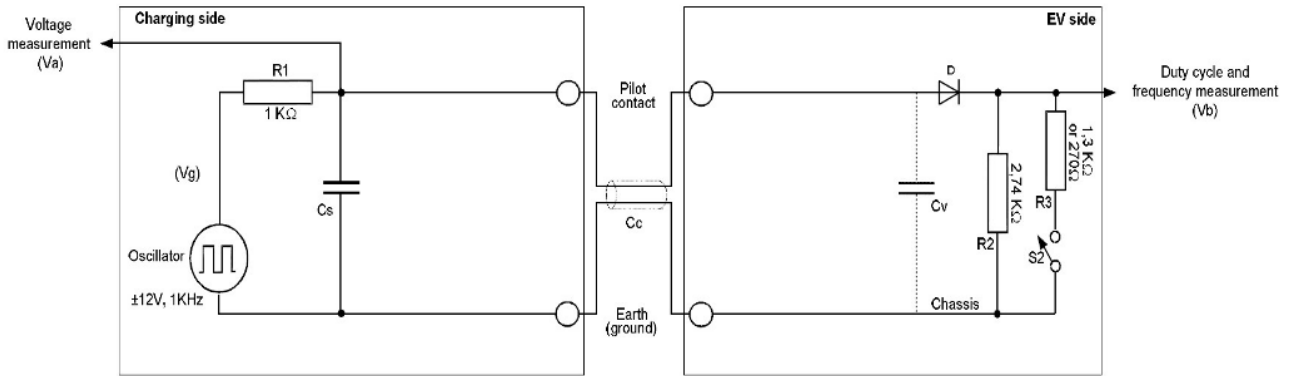

Source: IEC 61851

Typical Pilot Electric Equivalent Circuit for Mode 3 Charging

Table A.2 – Vehicle Control Pilot Circuit Values and Parameters
(see figures A.1 and A.2)

Parameter	Symbol	Value	Value Range	Units
Permanent resistor value	R2	2,740	2658 - 2822	Ω
Switched resistor value for vehicles not requiring ventilation	R3	1,300	1261 - 1339	Ω
Switched resistor value for vehicles requiring ventilation	R3	270	261.9 - 278.1	Ω
Equivalent total resistor value no ventilation (Figure A.2)	Re	882	856 - 908	Ω
Equivalent total resistor ventilation required (Figure A.2)	Re	246	239 - 253	Ω
Diode voltage drop (2.75 – 10 mA, -40 °C to +85 °C)	V _d	0.7	0.55 – 0.85	V
Maximum total equivalent input capacity	Cv	2,400	N/A	pF

Value ranges are to be maintained over full useful life and under design environment conditions.

Note: 1% resistors commonly recommended for this application

Source: IEC 61851

System States – PWM Voltage

Table A.3 – System States

System state	EV connected to the EVSE	S2	EV ready to receive energy	EVSE ready to supply energy	EVS supply energy	Va ^a			Remark	
						High level	Low level			
A1	no	N/A	no	not ready	off	12 V ^d	N/A	Steady voltage	V _b = 0 V	
A2			no	ready	off	12 V ^d	-12 V ^e	PMW		
B1	yes	open	no	not ready	off	9 V ^b	N/A	Steady voltage	R2 detected	
B2			no	ready	off	9 V ^b	-12 V ^e	PMW		
C1	yes	closed	yes	not ready	off	6 V ^c	N/A	Steady voltage	R3 = 1.3 kΩ ± 3% Charging area ventilation not required	
C2			yes	ready	off	6 V ^c	-12 V ^e	PMW		
D1			yes	not ready	off	3 V ^c	N/A	Steady voltage		R3 = 270 Ω ± 3% Charging area ventilation required
D2			yes	ready	off	3 V ^c	-12 V ^e	PMW		
E	yes	N/A	no	not ready	off	0 V		Steady voltage	V _b = 0: EVSE or utility problem or utility power not available or pilot short to earth	
F	yes	N/A	no	not ready	off	N/A	-12 V	Steady voltage	EVSE not available	

^a All voltages are measured after stabilization period.

^b The EVSE generator may apply a steady- state DC voltage or a +12 V square wave during this period. The duty cycle indicates the available current as in Table A.5.

^c The voltage measured is a function of the value of R3 in Figure A.1 (indicated as Re in Figure A.2).

^d 12 V static voltage

^e The EVSE shall check pilot line low state of -12 V, diode presence, at least at the transition between B1 and B2 (or at least once before the closing of the supply switch on the EVSE).

The state changes between A, B, C and D are caused by the EV, the state changes between 1 and 2 are created by the EVSE.

Source: IEC 61851

System States – PWM Voltage

Table A.201 – Pilot Voltage Range

The following table details the pilot voltage range as a result of tables A.1 and A.2 components values. These voltage ranges applies to the EVSE (Va).

State / Range	Nominal voltage range imposed by the system			Acceptable voltage range recognized to detect the states ^a		
	Minimum [V]	Nominal [V]	Maximum [V]	Minimum [V]	Nominal [V]	Maximum [V]
States A1, A2 /positive	11.4	12	12.6	11	12	13
States B1, B2 /positive	8.37	9	9.59	8	9	10
States C1, C2 /positive	5.47	6	6.53	5	6	7
States D1, D2 /positive	2.59	3	3.28	2	3	4
State E	0	0	1	-1	0	1
States A2, B2, C2, D2/ negative State F ^a	-12.6	-12	-11.4	-13	-12	-11

^a applicable to Va only

Note: the EVSE may also be designed to use the voltage of the internal generator (Vg) as a reference. The valid voltage ranges are then to be calculated as given in the following table. These ranges are identical to the values in the above table for Vg=12 V.

Source: IEC 61851

System States – PWM Voltage

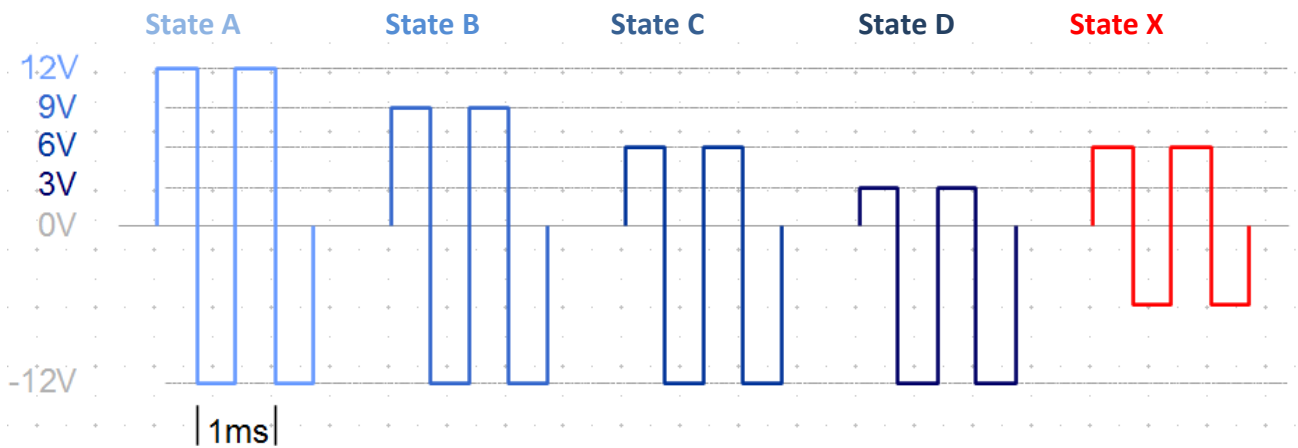

- State A: No vehicle connected
- State B: Vehicle connected but not ready for charging
- State C: Vehicle ready for charging without ventilation
- State D: Vehicle ready for charging with ventilation
- State X: Error

System States – Duty Cycle

Table A.6 – Maximum Current to be Drawn by the Vehicle

Nominal duty cycle interpretation by vehicle	Maximum current to be drawn by vehicle
Duty cycle < 3%	Charging not allowed
$3\% \leq \text{duty cycle} \leq 7\%$	A duty cycle of 5% indicates that digital communication is required and must be established between the EVSE and EV before charging. Charging is not allowed without digital communication. Digital communication may also be used with other duty cycles.
$7\% < \text{duty cycle} < 8\%$	Charging not allowed
$8\% \leq \text{duty cycle} < 10\%$	6 A
$10\% \leq \text{duty cycle} \leq 85\%$	available current = (% duty cycle) x 0.6 A
$85\% < \text{duty cycle} \leq 96\%$	available current = (% duty cycle - 64) x 2.5 A
$96\% < \text{duty cycle} \leq 97\%$	80 A
duty cycle > 97%	Charging not allowed
<p>If the PWM signal is between 8% and 97%, the maximum current may not exceed the values indicated by the PVM even if the digital signal indicates a higher current.</p> <p>In 3-phase systems, the duty cycle value indicates the current limit per each phase. The current indicated by the PWM signal shall not exceed the current cable capability and the EVSE capability, the lower between them shall apply.</p>	

Note: the EV should respect 6A as lower value of the PWM.

Note: the indication "no maximum" implies that the delay time has no constraints and may depend on external influences and the conditions existing on the EVSE or the EV.

Source: IEC 61851

System States – Duty Cycle

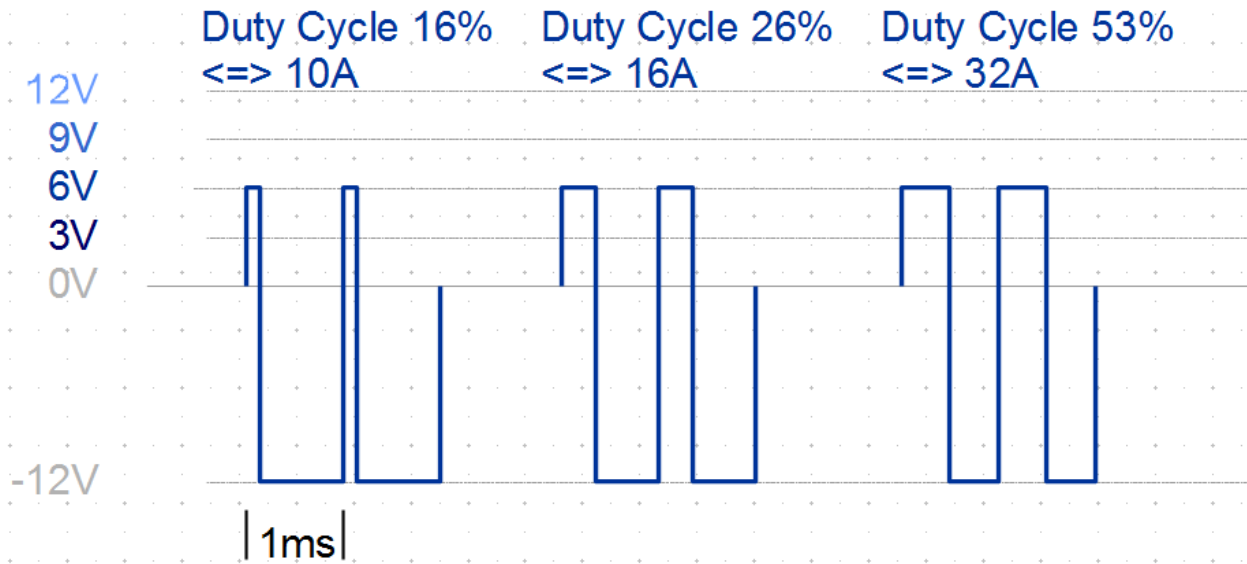

Diagnostics Unit for Testing Charging Points

Vehicle simulation

- A charging point is more than just a simple electrical outlet and it only functions when a vehicle is detected.
- The diagnostics unit is capable of simulating a vehicle.

Diagnosis

- The evaluation of the PWM signal, the cable coding for the phases, turn-off times and the direction of phase rotation are significant with regard to diagnosis.
- The diagnostics unit displays this information.

Diagnosis Procedure for a Charging Point

- Switch back and forth between states.
- Check parameters and turn-off times.
- Switch back and forth between cables.
- Check parameters.
- Trigger errors.
- Check system performance.

Error diagnosis:

Error:
L2 not connected
or fuse L2 blown

evaluation of <u>pwm</u> signal	
<u>voltage positive</u>	3,0V
<u>voltage negative</u>	-12,0V
<u>pwm frequency</u>	1000Hz
<u>charging current</u>	16A
<u>duty dycle:</u>	27%
<u>Switch-off time:</u>	invalid

Schematic diagram showing a car battery (ZOR), a fuse, a diode, and components labeled CP, PE, and RCD with checkmarks.

Error diagnosis:

Error:
No PWM signal

Signal generation or cable
connection defective

evaluation of <u>pwm</u> signal	
<u>voltage positive</u>	0,0V
<u>voltage negative</u>	0,0V
<u>pwm frequency</u>	no signal
<u>charging current</u>	0A
<u>duty dycle:</u>	0%
<u>Switch-off time:</u>	1mS

Schematic diagram showing a car battery (ZOR), a fuse, a diode, and components labeled CP, PE, and RCD with checkmarks.

Error diagnosis:

Error:

Incorrect values for duty cycle and charging current

Cable detection defective

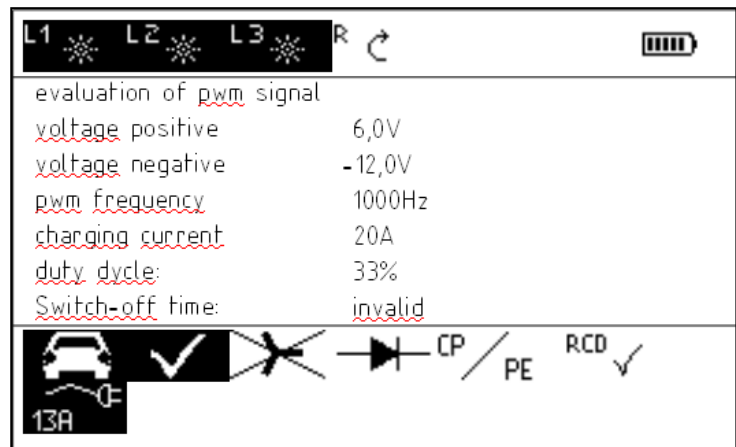

Error diagnosis:

Error:

Erroneous values for PWM, voltage and frequency

Signal generation defective or

CP and PP connections reversed

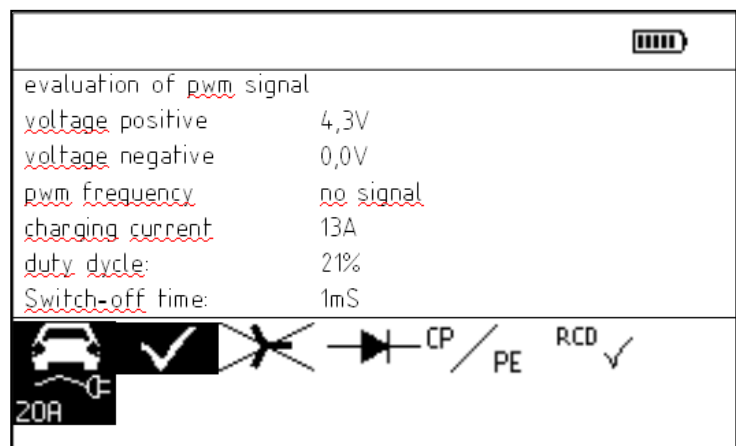

Repair and Replacement Parts Service Calibration Center* and Rental Instrument Service

If required please contact:

GMC-I Service GmbH
Service Center
Thomas-Mann-Str. 20
90471 Nürnberg, Germany
Phone: +49-911-817718-0
Fax: +49-911-817718-253
e-mail: service@gossenmetrawatt.com
www.gmci-service.com

This address is only valid in Germany. Please contact our representatives or subsidiaries for service in other countries.

* **DAkKS calibration laboratory for electrical quantities,
registration no. D-K-15080-01-01,
accredited per DIN EN ISO/IEC 17025:2005**

Accredited quantities: direct voltage, direct current value, direct current resistance, alternating voltage, alternating current value, AC active power, AC apparent power, DC power, capacitance, frequency and temperature

Product Support

If required please contact:

GMC-I Messtechnik GmbH
Product Support Hotline
Phone: +49-911-8602-0
Fax: +49 911 8602-709
e-mail: support@gossenmetrawatt.com

Edited in Germany • Subject to change without notice • PDF version available on the Internet



GMC-I Messtechnik GmbH
Südwestpark 15
90449 Nürnberg, Germany

Phone: +49-911-8602-111
Fax: +49 911 8602-777
e-mail: info@gossenmetrawatt.com
www.gossenmetrawatt.com