



## **MultiservicerXA**

**MI 3321**

## **User Manual**

*Ver. 2.4, Code no. 20 751 513*



*Distributor:*

*Manufacturer:*

Metrel d.d.  
Ljubljanska cesta 77  
SI-1354 Horjul  
E-mail: [metrel@metrel.si](mailto:metrel@metrel.si)  
<http://www.metrel.si>

© 2010 - 2014 Metrel

 Mark on your equipment certifies that this equipment meets the requirements of the EU (European Union) regulations concerning safety and electromagnetic compatibility
--

No part of this publication may be reproduced or utilized in any form or by any means without permission in writing from METREL.

<b>1</b>	<b>General description .....</b>	<b>8</b>
1.1	Warnings .....	9
1.2	Warning markings on connector panel .....	9
1.3	Standards applied .....	9
<b>2</b>	<b>Instrument description .....</b>	<b>11</b>
2.1	Front panel .....	11
2.2	Safety pre-tests .....	12
2.3	Symbols and messages .....	13
2.4	Dual supply voltage operation .....	16
<b>3</b>	<b>Technical specifications.....</b>	<b>17</b>
3.1	Withstanding 1890 V, 2500 V .....	17
3.2	Withstanding 1000 V .....	17
3.3	Discharging time.....	18
3.4	Continuity .....	18
3.5	Insulation resistance, Insulation – S resistance.....	19
3.6	Subleakage current, Subleakage – S current .....	19
3.7	Differential Leakage current .....	20
3.8	Power / Functional test.....	20
3.9	Touch leakage current.....	20
3.10	Polarity test.....	21
3.11	Clamp current.....	21
3.12	PRCD testing.....	21
3.13	RCD testing .....	22
3.13.1	<i>General data .....</i>	<i>22</i>
3.13.2	<i>Contact voltage RCD-Uc.....</i>	<i>22</i>
3.13.3	<i>Trip-out time .....</i>	<i>23</i>
3.13.4	<i>Trip-out current.....</i>	<i>23</i>
3.14	Fault loop impedance .....	24
3.14.1	<i>Zs .....</i>	<i>24</i>
3.14.2	<i>Zs(rcd), Rs(rcd) .....</i>	<i>24</i>
3.14.3	<i>High precision fault loop impedance <math>Z_{m\Omega L-Pe}</math> .....</i>	<i>25</i>
3.14.4	<i>Contact voltage .....</i>	<i>25</i>
3.15	Line impedance .....	26
3.15.1	<i>High precision line impedance .....</i>	<i>26</i>
3.16	Voltage, frequency, and phase rotation .....	27
3.16.1	<i>Phase rotation .....</i>	<i>27</i>
3.16.2	<i>Voltage, Frequency .....</i>	<i>27</i>
3.17	General data.....	28
<b>4</b>	<b>Main menu and test modes .....</b>	<b>30</b>
4.1	Help menus .....	30
4.2	Instrument main menu.....	31
4.3	General settings menu .....	31
4.3.1	<i>Setting date and time .....</i>	<i>32</i>
4.3.2	<i>Language selection .....</i>	<i>32</i>
4.3.3	<i>Print header.....</i>	<i>33</i>
4.3.4	<i>Viewing of instrument data .....</i>	<i>33</i>
4.3.5	<i>Display contrast adjustment .....</i>	<i>34</i>

4.3.6	<i>Reset instrument settings</i> .....	34
4.3.7	<i>Communication settings</i> .....	35
4.3.8	<i>Edit User / device data menu</i> .....	36
4.3.8.1	Users submenu.....	36
4.3.8.2	Devices submenu.....	37
4.3.8.3	Test sites submenu.....	37
4.3.8.4	Locations submenu.....	38
4.3.9	<i>Password</i> .....	39
4.3.10	<i>Result</i> .....	40
<b>5</b>	<b>PAT testing operating mode</b> .....	<b>41</b>
5.1	PAT testing main menu .....	41
5.2	VDE organizer menu .....	41
5.3	Autotest custom menu.....	42
5.4	Project autotests menu.....	42
5.5	Barcode / TAG menu.....	42
5.6	Single test menu.....	43
5.7	Recall/ delete/ send results menu .....	43
5.8	Data upload / download menu .....	44
5.9	Setup menu .....	44
5.9.1	<i>Instrument settings</i> .....	44
<b>6</b>	<b>Single tests in PAT testing mode</b> .....	<b>46</b>
6.1	Performing measurements in single test mode .....	46
6.2	Measurements – Single tests for appliances .....	47
6.2.1	<i>Earth bond resistance</i> .....	47
6.2.1.1	Compensation of test leads resistance .....	48
6.2.2	<i>Insulation resistance</i> .....	48
6.2.3	<i>Insulation resistance - S</i> .....	51
6.2.4	<i>Substitute leakage current</i> .....	53
6.2.5	<i>Substitute leakage - S</i> .....	55
6.2.6	<i>Differential leakage current</i> .....	57
6.2.7	<i>Touch leakage current</i> .....	58
6.2.8	<i>Polarity test</i> .....	60
6.2.9	<i>Clamp current test</i> .....	61
6.2.10	<i>PRCD test</i> .....	64
6.2.10.1	PRCD single test.....	65
6.2.10.2	Automatic PRCD test .....	66
6.2.11	<i>Power / Functional test</i> .....	68
6.3	Measurements – Single tests for welding machines.....	69
6.3.1	<i>Continuity of the protective circuit</i> .....	69
6.3.2	<i>Insulation resistance (supply circuit to protective circuit)</i> .....	70
6.3.3	<i>Insulation resistance (welding circuit to protective circuit)</i> .....	71
6.3.4	<i>Insulation resistance (supply circuit to welding circuit)</i> .....	72
6.3.5	<i>Insulation resistance (supply circuit of class II equipment to accessible surfaces)</i> .....	73
6.3.6	<i>Welding circuit leakage current</i> .....	74
6.3.7	<i>Primary leakage current</i> .....	75
6.3.8	<i>Touch leakage current</i> .....	76
6.3.9	<i>No load voltage</i> .....	76
6.3.10	<i>Clamp current test</i> .....	77

6.3.11	Functional test.....	77
<b>7</b>	<b>Autotest sequences .....</b>	<b>78</b>
7.1	VDE organizer – general menu .....	78
7.1.1	VDE organizer operation .....	80
7.1.2	Example of creating a test sequence with VDE organizer.....	81
7.2	Custom autotests .....	82
7.2.1	Deleting an existing custom test sequence .....	83
7.2.2	Viewing, modifying and saving an custom autotest.....	83
7.3	Project autotests.....	85
7.3.1	Selecting a project autotest.....	85
7.3.2	Starting a project autotest .....	88
7.3.3	Comparison of results (evaluation of result trends) .....	88
7.4	Barcode / TAG autotests .....	89
7.4.1	Working with RFID tags.....	90
7.4.2	Working with barcode reader .....	92
7.5	Performing autotest sequences – for appliances.....	93
7.5.1	Visual inspection .....	93
7.5.2	Earth bond resistance measurement.....	94
7.5.3	Insulation resistance measurement.....	94
7.5.4	Insulation resistance S measurement .....	95
7.5.5	Substitute leakage current measurement.....	95
7.5.6	Substitute leakage S measurement.....	95
7.5.7	Differential leakage current .....	96
7.5.8	Touch leakage current measurement.....	96
7.5.9	Polarity test .....	97
7.5.10	TRMS current measurement using clamp current adapter.....	97
7.5.11	PRCD test .....	97
7.5.12	Functional test.....	98
7.6	Performing autotest sequences – for welding machines .....	98
7.6.1	Visual inspection .....	98
7.6.2	Continuity of the protective circuit .....	99
7.6.3	Insulation resistance (supply circuit to protective circuit).....	100
7.6.4	Insulation resistance (welding circuit to protective circuit).....	100
7.6.3	Insulation resistance (supply circuit to welding circuit) .....	100
7.6.6	Insulation resistance (supply circuit of class II equipment to accessible surfaces).....	101
7.6.7	Welding circuit leakage current .....	101
7.6.8	Primary leakage current .....	101
7.6.9	Touch leakage current.....	102
7.6.10	No load voltage .....	102
7.6.11	TRMS current measurement using clamp current adapter.....	103
7.6.12	Functional test.....	103
<b>8</b>	<b>Working with autotest results .....</b>	<b>104</b>
8.1	Saving autotest results .....	104
8.2	Recalling results .....	105
8.3	Deleting results.....	107
8.4	Downloading and printing results .....	108
8.5	Data upload / download.....	112

8.6	Setup menu .....	113
8.6.1	<i>Instrument settings</i> .....	113
<b>9</b>	<b>Machine testing operating mode .....</b>	<b>115</b>
9.1	Single tests (machine testing) menu .....	115
9.2	Measurements and inspections .....	116
9.2.1	<i>Visual test</i> .....	116
9.2.2	<i>Continuity</i> .....	117
9.2.2.1	Single continuity test .....	118
9.2.2.2	Auto-continuity test .....	119
9.2.2.3	Compensation of test leads resistance .....	121
9.2.3	<i>Insulation resistance</i> .....	121
9.2.4	<i>High Voltage withstanding test</i> .....	123
9.2.5	<i>Loop impedance and prospective fault current</i> .....	126
9.2.5.1	Z mΩL-Pe, High precision loop impedance measurement .....	129
9.2.6	<i>RCD tests</i> .....	131
9.2.6.1	Contact voltage (RCD U <sub>c</sub> ) .....	132
9.2.6.2	Trip out time (RCD t) .....	134
9.2.6.3	Trip out current (RCD I) .....	134
9.2.6.4	RCD Autotest .....	135
9.2.7	<i>PRCD test</i> .....	137
9.2.8	<i>Discharging Time</i> .....	137
9.2.9	<i>Voltage</i> .....	140
9.2.10	<i>Functional test</i> .....	142
<b>10</b>	<b>Switchgear testing operating mode .....</b>	<b>144</b>
10.1	Single tests (switchgear testing) menu .....	144
10.2	Measurements and inspections .....	145
10.2.1	<i>Visual test</i> .....	145
10.2.2	<i>Continuity</i> .....	146
10.2.2.1	Single continuity test .....	147
10.2.2.2	Auto-continuity test .....	148
10.2.2.3	Compensation of test leads resistance .....	150
10.2.3	<i>Insulation resistance</i> .....	150
10.2.4	<i>High Voltage withstanding test</i> .....	152
10.2.5	<i>Discharging Time</i> .....	155
10.2.6	<i>Voltage</i> .....	157
10.2.7	<i>RCD test</i> .....	159
10.2.8	<i>PRCD test</i> .....	159
10.2.9	<i>Functional test</i> .....	159
10.2.10	<i>Power</i> .....	160
<b>11</b>	<b>All tests operating mode .....</b>	<b>161</b>
11.1	Single tests (All tests) menu .....	161
11.1.1	<i>Visual test</i> .....	162
11.1.2	<i>Continuity of protective conductors</i> .....	162
11.1.3	<i>Insulation resistance</i> .....	162
11.1.4	<i>Insulation resistance –S</i> .....	162
11.1.5	<i>Substitute leakage current</i> .....	162
11.1.6	<i>Substitute leakage current - S</i> .....	162
11.1.7	<i>Leakage current</i> .....	162

11.1.8	<i>Touch leakage current</i> .....	163
11.1.9	<i>Polarity test</i> .....	163
11.1.10	<i>Clamp current test</i> .....	163
11.1.11	<i>RCD test</i> .....	163
10.2.12	<i>PRCD test</i> .....	163
11.1.13	<i>Functional test</i> .....	163
11.1.14	<i>HV test</i> .....	163
11.1.15	<i>Line impedance and prospective short circuit current test</i> .....	163
11.1.15.1	Low line impedance.....	165
11.1.16	<i>Loop impedance test and prospective fault current</i> .....	168
11.1.17	<i>Voltage</i> .....	168
11.1.18	<i>Discharging time</i> .....	168
11.1.19	<i>Power</i> .....	168
<b>12</b>	<b>Working with results in Machine testing, Switchgear testing and All tests operating mode</b> .....	<b>169</b>
12.1	Memory organization.....	169
12.2	Saving single test results.....	169
12.3	Recalling projects.....	170
12.4	Deleting single test results.....	172
12.5	Deleting project(s).....	172
12.6	Downloading and printing results .....	173
<b>13</b>	<b>Maintenance</b> .....	<b>176</b>
13.1	Periodic calibration .....	176
13.2	Fuses.....	176
13.3	Service .....	176
13.4	Cleaning .....	176
<b>14</b>	<b>Instrument set and accessories</b> .....	<b>177</b>
<b>A</b>	<b>Appendix A – Preprogrammed autotests</b> .....	<b>178</b>
<b>B</b>	<b>Appendix B – Autotest shortcut codes</b> .....	<b>187</b>
<b>C</b>	<b>Appendix C - Fuse table / I<sub>PSC</sub></b> .....	<b>189</b>

# 1 General description

The multifunctional portable test instrument MultiservicerXA is intended to perform all measurements for testing the electrical safety of portable electrical equipment, machines and switchboards. The following tests can be performed:

- Earth bond / Continuity test,
- Insulation resistance,
- Substitute leakage current,
- Differential leakage current,
- Touch leakage current,
- IEC cord polarity test,
- Leakage and TRMS load currents with current clamp,
- Portable RCD test,
- Power test,
- Three phase voltage/ rotary field,
- Line and Loop impedance,
- RCD test,
- Discharging time,
- High voltage (Withstanding) test,
- Functional and Visual inspection,

The measurements are divided into four subgroups:

- Tests for testing portable DUTs acc. to VDE 0701-0702
- Tests for testing electrical safety of machines acc. to IEC/EN 60204 Ed.5
- Tests for testing safety of switchboards IEC/ EN 60439 and IEC 61439
- All tests. Because of the large set of functions the instruments is suitable also for safety testing (type testing, maintenance, routine testing) according to other product standards.

In addition with the optional instruments A1322 active tests of three phase appliances can be carried out.

With the optional instruments A1422 active tests of three phase appliances and testing of welding machines acc. to EN 60974 / VDE 0544 can be carried out.

The instrument has a powerful test data management system. Autotests and single tests can be stored (depending on the application) in approx. 6000 memory locations.

Some instrument's highlights:

- Large graphic LCD display with resolution of  $240 \times 128$  dots, with back-light,
- Over 6000 memory locations in data flash memory for storing test results & parameters,
- Four communication ports (USB and 3 RS232C) for communication with PC, barcode reader/writer and printers,
- Soft touch keyboard with cursor keys,
- Built in real time clock,
- Fully compatible with new METREL PATLink PRO PC software package.

In PAT testing operating mode powerful functions for fast and efficient periodic testing are included:



- Pre-programmed test sequences,
- Fast testing with barcode identification systems,
- Test data can be uploaded from PC,
- On site comparisons between old and new test results can be performed,
- Enables on site printing of test labels.

## 1.1 Warnings

In order to reach high level of operator safety while carrying out various measurements using MultiservicerXA instrument, as well as to keep the test equipment undamaged, it is necessary to consider the following general warnings:

- Read this user manual carefully, otherwise use of the instrument may be dangerous for the operator, for the instrument or for the equipment under test!**
-  Warning on the instrument means »Read the Instruction manual with special care to safety operation«. The symbol requires an action!**
- If the test equipment is used in manner not specified in this user manual the protection provided by the equipment may be impaired!**
- Do not use the instrument and accessories if any damage is noticed!**
- Consider all generally known precautions in order to avoid risk of electric shock while dealing with hazardous voltages!**
- Do not use the instrument in supply systems with voltages higher than 300 V!**
- Use only standard or optional test accessories supplied by your distributor!**
- The protection class of the TP1 test terminal is CAT III / 300V. It means that maximum allowed voltage between test terminals and ground is 300 V!**
- Use only correctly earthed mains outlets to supply the instrument!**
- In case a fuse has blown follow the instructions in this user manual to replace it!**
- Instrument servicing and calibration is allowed to be carried out only by a competent authorized person!**
- Hazardous voltages of up to 2800 V are applied to the HV terminals during the Withstanding test. It is advisable to keep the current trip out limit as low as possible. Risk of electric shock!**
- It is advisable not to run tested devices with load currents above 13 A for more than 15 minutes. Load currents higher than 13 A can result in high temperatures of On/Off switch and fuse holders!**

## 1.2 Warning markings on connector panel

Refer to chapter 2.1 *Front panel*.

## 1.3 Standards applied

The MultiservicerXA instrument is manufactured and tested according to the following regulations, listed below.

### **Electromagnetic compatibility (EMC)**

EN 61326 -1	Electrical equipment for measurement, control and laboratory use – EMC requirements Class B (Portable equipment used in controlled EM environments)
-------------	--

### Safety (LVD)

EN 61010 - 1	Safety requirements for electrical equipment for measurement, control, and laboratory use – Part 1: General requirements
EN 61010-2-030	Safety requirements for electrical equipment for measurement, control and laboratory use – Part 2-030: Particular requirements for testing and measuring circuits
EN 61010 - 031	Safety requirements for electrical equipment for measurement, control and laboratory use - Part 031: Safety requirements for hand-held probe assemblies for electrical measurement and test
EN 61010-2-032	Safety requirements for electrical equipment for measurement, control, and laboratory use - Part 2-032: Particular requirements for hand-held and hand-manipulated current sensors for electrical test and measurement

### Functionality

VDE 0404-1	Testing and measuring equipment for checking the electric safety of electric devices - Part 1: General requirements
VDE 0404-2	Testing and measuring equipment for checking the electric safety of electric devices - Part 2: Testing equipment for tests after repair, change or in the case of repeat tests
VDE 0701-702	Inspection after repair, modification of electrical appliances – Periodic inspection on electrical appliances General requirements for electrical safety
EN 60204-1 Ed.5	Safety of machinery - Electrical equipment of machines - Part 1: General requirements
EN 60439	Low-voltage switchgear and controlgear assemblies
IEC 61439-1	Low-voltage switchgear and controlgear assemblies - Part 1: General rules
IEC 61008-1	Residual current operated circuit-breakers without integral overcurrent protection for household and similar uses (RCCBs) - Part 1: General rules
IEC 62423	Type F and type B residual current operated circuit-breakers with and without integral overcurrent protection for household and similar uses

### Note about EN and IEC standards:

Text of this manual contains references to European standards. All standards of EN 6xxxx (e.g. EN 61010) series are equivalent to IEC standards with the same number (e.g. IEC 61010) and differ only in amended parts required by European harmonization procedure.

### Notes:

Various devices and appliances can be tested by MultiservicerXA and in further text the common DUT (abbreviation for Device Under Test) is applied.

## 2 Instrument description

### 2.1 Front panel

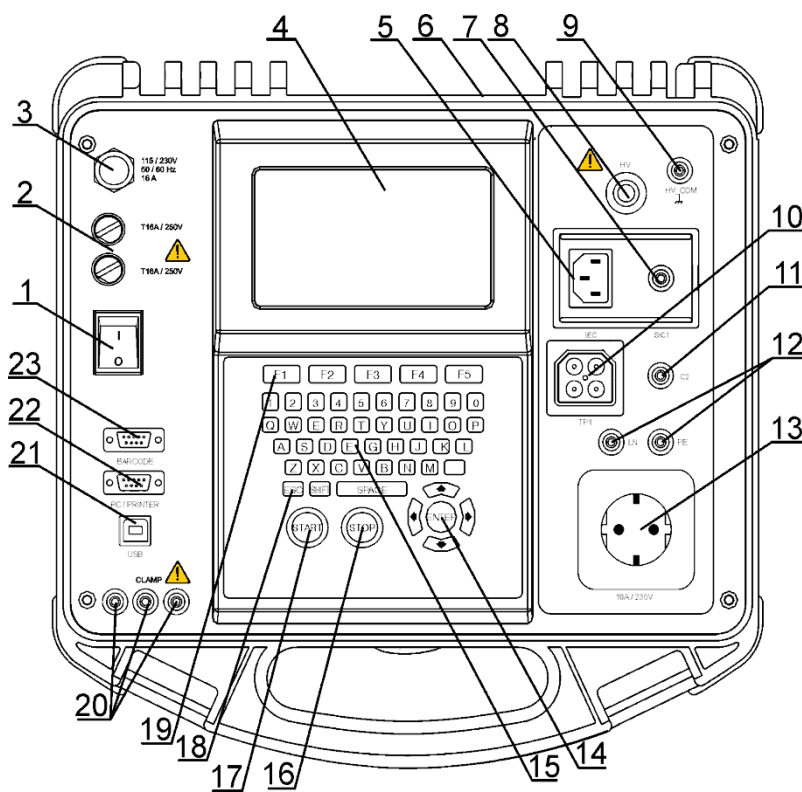

Front panel

Legend:

- 1 Mains switch with indicator.
- 2 Two T16 A / 250 V fuses for instrument protection.
- 3 Mains supply cord.
- 4 240 × 128 dots graphic matrix display with backlight.
- 5 IEC appliance connector for testing supply cords.  
**Warning!**  
 **The connector input is for test purpose only; do not connect it to the mains supply!**
- 6 Label printer connector on back side (special instrument versions).
- 7 Test probe (S/C1) connector, used as output for earth bond/ continuity tests and probe input in for class 2 equipment tests (insulation resistance-S, substitute leakage-S and touch leakage currents ).
- 8 HV test connector output.  
**Warning!**  
 **A high and dangerous voltage of up to 2800 V ac is applied at this output during the measurement!**
- 9 HV\_PE test connector return, functional earth of test system.  
**Note:**  
 HV source is referenced to earth (PE), this means that there shall be proper prepared set-up for withstanding testing.

10	TP1 test socket for testing line impedance, loop impedance, voltage and residual current devices, discharge time.
11	C2 connector, used as output for continuity tests (in machine, switchboard and All operating modes).
12	LN and PE sockets for testing the insulation resistance and substitute leakage current of fixed installed DUTs. <b>Warning!</b> <input type="checkbox"/> <b>These sockets are intended only for the connection to de-energized devices.</b>
13	Test socket (230 V). <b>Warning!</b> <input type="checkbox"/> <b>Dangerous voltage is present on the test socket during the measurement. Maximum output current is 16 A, test only devices with maximum rated supply current not higher than 16 A!</b> <b>Note:</b> <input type="checkbox"/> For devices incorporating high reactive loading, e.g. motor with rated power >1.5 kW, it is recommended to start measurement first and to turn on the tested device later.
14	Cursor keys and ENTER key.
15	Alpha-numeric keyboard.
16	STOP key.
17	START key.
18	ESCAPE key.
19	Function keys intended for displayed defined options.
20	Current clamp adapter input sockets. <b>Warnings!</b> <input type="checkbox"/> <b>Do not connect any voltage source on this input. It is intended only for connection of current clamp with current output. Maximum input current is 30 mA!</b> <input type="checkbox"/> <b>Green socket is connected to the functional earth of the system and is intended for connection with shield of current clamps only.</b>
21	USB connector.
22	PC / printer / A1143 (option) connector.
23	Barcode reader / writer connector.

## 2.2 Safety pre-tests

Before performing a measurement, the instrument performs a series of pre-tests to ensure safety and to prevent any damage. These safety pre-tests are checking for:

- Any external voltage against earth on mains test socket,
- Excessively high leakage current,
- Excessively high touch leakage current,
- Short circuit or too low resistance between L and N of tested device,
- Correct input mains voltage,
- Input PE connection,
- Presence of HV\_PE test lead during withstanding tests.

If pre-tests fail, an appropriate warning message will be displayed.

The warnings and measures are described in chapter 2.3 *Symbols and messages*.

## 2.3 Symbols and messages

<p><b>Mains voltage is not correct or PE not connected. Check mains voltage and PE connection!</b></p>	<p>Warning for improper supply voltage condition. Possible causes:</p> <ul style="list-style-type: none"> <li>- No earth connection or other wiring problem on supply socket.</li> <li>- Incorrect mains voltage.</li> </ul> <p>Determine and eliminate the problem before proceeding! <b>Warning:</b></p> <ul style="list-style-type: none"> <li>- <b>The instrument must be earthed properly!</b></li> </ul>
<p><b>Warning! Instrument is connected to the IT earthing system or PE not connected. Press START key to continue.</b></p>	<p>Supply voltage warning. Possible causes:</p> <ul style="list-style-type: none"> <li>- No earth connection,</li> <li>- Instrument connected to an IT earthing system.</li> </ul> <p>Press the START key to continue if instrument is connected to the IT supply system. <b>Warning:</b></p> <ul style="list-style-type: none"> <li>- <b>The instrument must be earthed properly!</b></li> </ul>
<p><b>Resistance L – N too high (&gt;30 kΩ). Check fuse and switch. Are you sure to proceed? (Y/N)</b></p>	<p>An excessively high resistance was measured in the fuse pre-test. Indication means that tested device has too low consumption or is:</p> <ul style="list-style-type: none"> <li>- Not connected,</li> <li>- Switched off,</li> <li>- Contains a fuse that has blown.</li> </ul> <p>Select <b>YES</b> or <b>NO</b> with Y or N key.</p>
<p><b>Resistance L – N low.  Are you sure to proceed? (Y/N)</b></p>	<p>A low resistance of the device under test (DUT) supply input was measured in the pre-test. This means that it is very likely that an excessively high current will flow after applying power to the DUT. If the high current is only of short duration (caused by a short inrush current) the test can be performed, otherwise not. Select <b>YES</b> or <b>NO</b> with Y or N key.</p>
<p><b>Resistance L – N too low.  Are you sure to proceed? (Y/N)</b></p>	<p>An extremely low resistance of the DUT supply input was measured in the pre-test. It is likely that fuses will blow after applying power to the DUT. If the too high current is only of short duration (caused by a short inrush current) the test can be performed otherwise it must be stopped. Select <b>YES</b> or <b>NO</b> with Y or N key. It is recommended to additionally check the DUT before proceeding with the test!</p>

<p><b>Leakage LN-PE high.</b></p> <p><b>Are you sure to proceed? (Y/N)</b></p>	<p>Dangerous leakage current (higher than 3.5 mA) will flow if power would be connected to DUT. Select <b>YES</b> or <b>NO</b> with Y or N key. Proceed with testing only if all safety measures have been taken. It is recommended to perform a thorough earth bond test on the PE of the DUT before proceeding with the test.</p>
<p><b>Leakage LN-PE too high.</b></p>	<p>Dangerous leakage current (higher than 20 mA) will flow if power would be connected to the DUT.</p> <p>Determine and eliminate the problem before proceeding!</p>
<p><b>Leakage LN-PE or S/C1-PE too high!</b></p> <p><b>Are you sure to proceed? (Y/N)</b></p>	<p>Dangerous leakage current (higher than 20 mA) would flow if power were connected to the DUT. Select <b>YES</b> or <b>NO</b> with Y or N key. Proceed with testing only if all safety measures have been taken. It is recommended to perform a thorough earth bond test on the PE of the DUT before proceeding with the test.</p>
<p><b>Measurement aborted! Differential leakage too high!</b></p>	<p>An exceptionally high leakage current (higher than about 5 mA) was measured through PE test terminal or PE socket during the pre-test or test.</p>
<p><b>Leakage test S/C1-PE too high!</b></p>	<p>An exceptionally high leakage current (higher than about 5 mA) was measured through S/C1 test terminal during the pre-test.</p>
<p><b>External voltage on test socket too high!</b></p>	<p><b>DANGER!</b></p> <ul style="list-style-type: none"> <li>- <b>Voltage on mains test socket or LN/PE terminals is higher than approximately 20 V (AC or DC)!</b></li> </ul> <p>Disconnect the DUT from the instrument immediately and determine why external voltage was detected!</p>
<p><b>External voltage on S/C1 too high!</b></p>	<p><b>DANGER!</b></p> <ul style="list-style-type: none"> <li>- <b>Voltage on test probe (S/C1) is higher than approximately 25 V (AC or DC)!</b></li> </ul> <p>Disconnect the test probe from the DUT and determine why external voltage was detected!</p>
<p><b>Test was skipped for safety!</b></p>	<p>Instrument skipped the required test because of a failed previous test.</p>
<p><b>Overheated!</b></p>	<p>Temperature of internal components of the instrument reached their top limit. Measurement is prohibited until the internal temperature has reduced.</p>

**Warning!**  
**More than 80 % of memory is occupied. Stored data should be downloaded to PC.**

Instrument memory is almost full. Download stored results to PC.

**Warning!**  
**Calibration has been expired.**

Recalibration of the instrument is required. Contact your dealer.

**Warning!**  
**Too high contact voltage.**

A too high contact voltage was detected before an RCD test being carried out. Check PE connections!

**Warning!**  
**Test lead disconnected.**

The test lead is not connected to the HV\_PE test terminal. Measurement is prohibited / interrupted.

**Hardware error.**  
**Return the instrument to the repair centre.**

The instrument detects a serious failure.



Connect the test lead to the S/C1 test socket.



Remove the S/C1 connection, especially if it is connected to any part that will begin to rotate or move when power is applied.



Connect the test leads to the S/C1 and C2 test sockets.



**Warning!**





A high voltage is / will be present on the instrument output! (Withstanding test voltage, Insulation test voltage, or mains voltage).



The DUT should be switched on (to ensure that the complete circuit is tested).



Connect the lead to be tested to the TP1 test terminal.

	Connect the lead to be tested to the IEC test terminal.
	Connect current clamp adapter in this test.
	Test passed.
	Test failed.
	Some tests in the autotest sequence were skipped, but all performed tests passed.

## 2.4 Dual supply voltage operation

The MultiservicerXA will accept either a 110 V or 230 V, 50 Hz or 60 Hz mains input.

### Notes:

- The PAT will conduct a leakage / power tests at the power up mains voltage. Therefore, to perform a run test on a 110 V DUT (e.g. 110 V drills), the PAT must be powered from a 110 V mains supply (or center tapped transformer).
- The mains voltage does not influence other measurements.



### 3 Technical specifications

#### 3.1 Withstanding 1890 V, 2500 V

##### Withstanding voltage

Range	Resolution	Accuracy
0 - 3000 V	1 V	$\pm(3\% \text{ of reading} + 5 \text{ digit})$

##### Withstanding current\*

Range	Resolution	Accuracy
0.0 - 99.9 mA	0.1 mA	$\pm(10\% \text{ of reading} + 8 \text{ digit})$

\* Displayed apparent current

Output voltage: ..... 1890 V ( $\pm 3\%$ )\*, 2500 V ( $\pm 3\%$ )\*, grounded  
 \*at mains voltage = 230 V and max. output current (= 100 mA)

grounded

Trip out current [mA]: ..... 2, 5, 10, 20, 50, 100; (accuracy  $\pm 10\%$ )

Trip out time: ..... < 30 ms

Timer [s]: ..... 2, 3, 5, 10, 30. START / STOP button must be pressed  
 for operation

Short circuit current at nominal output voltage..... > 200 mA

Test terminals:

Withstanding voltage	HV socket, HV_PE
----------------------	------------------

#### 3.2 Withstanding 1000 V

##### Withstanding voltage

Range	Resolution	Accuracy
0 - 1500 V	1 V	$\pm(3\% \text{ of reading} + 5 \text{ digit})$

##### Withstanding current\*

Range	Resolution	Accuracy
0.0 - 199.9 mA	0.1 mA	$\pm(5\% \text{ of reading} + 5 \text{ digit})$
200 - 500 mA	1 mA	$\pm(5\% \text{ of reading} + 5 \text{ digit})$

\* Displayed apparent current

Output voltage / power:..... 1000 V -0 %, +20 % / 200 W at  $U_{\text{mains}}$  230 V, grounded

Trip out current [mA]: ..... 5, 10, 20, 50, 100, 200; (accuracy  $\pm 10\%$ )

Trip out time:..... <30 ms

Timer [s]:..... 2, 3, 5, 10, 30. START / STOP button must be pressed  
 for operation

Short circuit current at nominal output voltage..... > 200 mA

Test terminals:

Withstanding voltage	HV socket, HV_PE
----------------------	------------------

### 3.3 Discharging time

#### Discharging time

Range	Resolution	Accuracy
0.0 – 9.9 s	0.1 s	±(5 % of reading + 3 digit)

#### Peak voltage

Range	Resolution	Accuracy
0.0 – 550 V	1 V	±(5 % of reading + 5 digit)

2 wires system, triggered on DC voltage falling slope

Max. working voltage: ..... 550 V peak

Min. working voltage: ..... 85, 170 V peak

Threshold values: ..... 1 s, 5 s

Threshold voltage level: ..... 60 V, 120 V

Input resistance: ..... 48 MΩ

Test terminals:

Discharging time	TP1 test terminal L↔N
------------------	-----------------------

### 3.4 Continuity

#### Continuity 10 A (PAT)

Range	Resolution	Accuracy
0.00 Ω ÷ 1.99 Ω	0.01 Ω	±(5 % of reading + 3 digits)
Indication range: 2.00 Ω ÷ 19.9 Ω		

#### Continuity 10 A (other)

Range	Resolution	Accuracy
0.000 Ω ÷ 0.999 Ω	0.001 Ω	±(5 % of reading + 6 digits)
1.00 Ω ÷ 1.99 Ω	0.01 Ω	±(5 % of reading + 3 digits)
Indication range: 2.00 Ω ÷ 19.9 Ω		

#### Continuity 200 mA

Range	Resolution	Accuracy
0.00 Ω ÷ 1.99 Ω	0.01 Ω	±(5 % of reading + 3 digits)
Indication range: 2.00 Ω ÷ 19.9 Ω		

Test currents: ..... 10 A into 100 mΩ at rated mains supply voltage

200 mA into 2.00 Ω

Open circuit voltage: ..... <9 V AC

Lead calibration: ..... yes,

Pass levels [Ω]: ..... 0.01 ÷ 0.09, 0.10 ÷ 0.90, 1.00 ÷ 9.00

Test duration [s]: ..... 5, 10, 30, 60, 120, 180

Test method: ..... 2-wire measurement, floating to earth

Test terminals:

Continuity (PAT)	S ↔ PE (mains test socket) ; (200 mA and 10 A) S ↔ PE; (200 mA)
Continuity (other)	S/C1 ↔ C2

### 3.5 Insulation resistance, Insulation – S resistance

#### Insulation resistance

Range	Resolution	Accuracy
0.000 M $\Omega$ ÷ 0.500 M $\Omega$	0.001 M $\Omega$	$\pm$ (10 % of reading + 5 digits)
0.501 M $\Omega$ ÷ 1.999 M $\Omega$	0.001 M $\Omega$	$\pm$ (5 % of reading + 3 digits)
2.00 M $\Omega$ ÷ 19.99 M $\Omega$	0.01 M $\Omega$	
20.0 M $\Omega$ ÷ 199.9 M $\Omega$	0.1 M $\Omega$	

#### Insulation – S resistance

Range	Resolution	Accuracy
0.000 M $\Omega$ ÷ 0.500 M $\Omega$	0.001 M $\Omega$	$\pm$ (10 % of reading + 5 digits)
0.501 M $\Omega$ ÷ 1.999 M $\Omega$	0.001 M $\Omega$	$\pm$ (5 % of reading + 3 digits)
2.00 M $\Omega$ ÷ 19.99 M $\Omega$	0.01 M $\Omega$	

Nominal voltages: ..... 250 V DC, 500 V DC (- 0 %, + 10 %)

Measuring current: ..... min. 1 mA at 250 k $\Omega$  (250 V), 500 k $\Omega$  (500 V)

Short circuit current: ..... max. 2.0 mA

Pass levels [M $\Omega$ ]: ..... 0.10, 0.30, 0.50, 1.00, 2.00, 4.0, 7.0, 10.0, none

Test duration [s]: ..... 5, 10, 30, 60, 120, none

Test terminals:

Insulation (PAT)	LN (mains test socket)/ LN $\leftrightarrow$ PE ( mains test socket) / PE/S
Insulation – S	LN(mains test socket)/ LN $\leftrightarrow$ S
Insulation (other)	LN $\leftrightarrow$ PE

### 3.6 Subleakage current, Subleakage – S current

#### Substitute leakage current

Range	Resolution	Accuracy
0.00 mA ÷ 19.99 mA	0.01 mA	$\pm$ (5 % of reading + 5 digits)

Open circuit voltage: ..... <50 V AC at rated mains voltage

Short circuit current: ..... <40 mA

Pass levels [mA]: ..... 0.25, 0.50, 0.75, 1.00, 1.50, 2.50, 3.50, 4.00, 4.50, 5.00, 5.50, 6.00, 7.00, 8.00, 9.00, 15.0

Test duration [s]: ..... 5, 10, 30, 60, 120, none

Displayed current: ..... calculated to DUT nominal mains supply voltage (110 V or 230 V) x 1.06.

Frequency response: ..... complies to EN61010-Figure A1

Test terminals:

Subleakage (PAT)	LN (mains test socket)/ LN $\leftrightarrow$ PE ( mains test socket) / PE/S
Subleakage – S	LN(mains test socket)/ LN $\leftrightarrow$ S
Subleakage (other)	LN $\leftrightarrow$ PE

### 3.7 Differential Leakage current

#### Differential leakage current

Range	Resolution	Accuracy
0.00 mA ÷ 9.99 mA	0.01 mA	±(5 % of reading + 5 digits)

Pass levels [mA]: ..... 0.25, 0.50, 0.75, 1.00, 1.50, 2.50, 3.00 mA, 3.50, 4.00, 4.50, 5.00, 5.50, 6.00, 7.00, 8.00, 9.00, none

Test duration [s] ..... 5, 10, 30, 60, 120, none

Frequency response: ..... complies to EN61010-Figure A1

Test terminals:

Differential leakage	mains test socket
----------------------	-------------------

### 3.8 Power / Functional test

#### Apparent power

Range	Resolution	Accuracy
0.00 kVA ÷ 4.00 kVA	0.01 kVA	±(5 % of reading + 3 digits)

Test duration [s]: ..... 5, 10, 30, 60, 120, none

Test terminals:

Power	mains test socket
-------	-------------------

### 3.9 Touch leakage current

#### Touch leakage current

Range	Resolution	Accuracy
0.00 mA ÷ 2.50 mA	0.01 mA	±(10 % of reading + 5 digits)

Pass levels [mA]: ..... 0.25, 0.50, 0.75, 1.00, 1.50, 2.00, none

Test duration [s]: ..... 5, 10, 30, 60, 120, none

Output: ..... test socket, test probe connector

Impedance,

Frequency response: ..... complies to EN61010-Figure A1

Test terminals:

Touch leakage	mains test socket or external source/ S
---------------	---

### 3.10 Polarity test

Test voltage ..... <50 V AC  
 Detects ..... Pass, L-open, N-open, PE-open, L-N crossed, L-PE crossed, N-PE crossed, L-N shorted, L-PE shorted, N-PE shorted, multiple faults

Test terminals:

Differential leakage	Mains test socket ↔ IEC
----------------------	-------------------------

### 3.11 Clamp current

**True RMS current** using 1000:1 current clamp

Range	Resolution	Accuracy*
0.00 mA ÷ 9.99 mA	0.01 mA	±(5 % of reading + 10 digits)
10.0 mA ÷ 99.9 mA	0.1 mA	±(5 % of reading + 5 digits)
100 mA ÷ 999 mA	1 mA	±(5 % of reading + 5 digits)
1.00 A ÷ 9.99 A	0.01 A	±(5 % of reading + 5 digits)
10.0 A ÷ 24.9 A	0.1 A	±(5 % of reading + 5 digits)

\*It does not consider accuracy of current transformer.

Pass levels [mA]: ..... 0.25, 0.50, 0.75, 1.00, 1.50, 2.25, 2.50, 3.00, 3.50, 5.00, 9.00, none

Test duration [s]: ..... 5, 10, 30, 60, 120, none

Test terminals:

Clamp current	Clamp inputs
---------------	--------------

Temperature coefficient outside reference temperature limits is 1 % of measured value per °C

### 3.12 PRCD testing

**Portable RCD trip-out time**

Range	Resolution	Accuracy
0 ms ÷ 300 ms ( $\frac{1}{2} \times I_{\Delta N}$ )	1 ms	±3 ms
0 ms ÷ 300 ms ( $I_{\Delta N}$ )	1 ms	
0 ms ÷ 40 ms ( $5 \times I_{\Delta N}$ )	1 ms	

Test currents ( $I_{\Delta N}$ ): ..... 10 mA, 15 mA, 30 mA

Test current multipliers: .....  $\frac{1}{2} \times I_{\Delta N}$ ,  $I_{\Delta N}$ ,  $5 \times I_{\Delta N}$

Start angle: ..... 0°, 180°, both

Test modes: ..... single, autotest

Voltage range: ..... 100 V ÷ 264 V (45 Hz ÷ 65 Hz)

Pass / Fail limits:

$\frac{1}{2} \times I_{\Delta N}$	$I_{\Delta N}$	$5 \times I_{\Delta N}$
$t_{\Delta} > 300$ ms	$t_{\Delta} < 300$ ms	$t_{\Delta} < 40$ ms

Test terminals:

PRCD testing	TP1 test sockets
--------------	------------------

### 3.13 RCD testing

#### 3.13.1 General data

Nominal residual current [mA]: . 10, 30, 100, 300, 500, 1000

Test current options: .....  $0.5 \times I_{\Delta N}$ ,  $I_{\Delta N}$ ,  $2 \times I_{\Delta N}$ ,  $5 \times I_{\Delta N}$

Test currents accuracy: .....  $-0 / +0.1 \cdot I_{\Delta}$ ;  $I_{\Delta} = I_{\Delta N}$ ,  $2 \times I_{\Delta N}$ ,  $5 \times I_{\Delta N}$   
 $-0.1 \cdot I_{\Delta} / +0$ ;  $I_{\Delta} = 0.5 \times I_{\Delta N}$

Test current shape: ..... Sine-wave (AC), pulsed (A), smooth DC (B)\*

DC offset for pulsed current: ..... 6 mA (typical)

RCD type: ..... G (non-delayed), S (time-delayed)

Test current starting polarity: .... (+) or (-)

Voltage range: ..... 40 V ÷ 264 V (45 Hz ÷ 65 Hz)

Test terminals:

RCD testing	TP1 test socket
-------------	-----------------

RCD test current selection (r.m.s. value calculated to 20 ms) according to IEC 61009:

$I_{\Delta N}$ (mA)	$I_{\Delta N} \times 1/2$			$I_{\Delta N} \times 1$			$I_{\Delta N} \times 2$			$I_{\Delta N} \times 5$			RCD $I_{\Delta}$		
	AC	A	B*	AC	A	B*	AC	A	B	AC	A	B*	AC	A	B*
10	5	3.5	5	10	20	20	20	40	40	50	100	100	✓	✓	✓
30	15	10.5	15	30	42	60	60	84	120	150	212	300	✓	✓	✓
100	50	35	50	100	141	200	200	282	400	500	707	1000	✓	✓	✓
300	150	105	150	300	424	600	600	848	n.a.	1500	n.a.	n.a.	✓	✓	✓
500	250	175	250	500	707	1000	1000	1410	n.a.	2500	n.a.	n.a.	✓	✓	✓
1000	500	350	500	1000	1410	n.a.	2000	n.a.	n.a.	n.a.	n.a.	n.a.	✓	✓	n.a.

n.a.....not applicable

AC type.....sine wave test current

A type.....pulsed current

B type\* .....smooth DC current

#### Note:

All data (marked with “\*”) regarding B type RCDs are valid for instrument HW version 3.0 and higher only.

#### 3.13.2 Contact voltage RCD-Uc

Measuring range according to EN 61557 is 7.5 V ÷ 62.0 V for limit contact voltage 50 V

Range	Resolution	Accuracy
0.0 ÷ 19.9 V	0.1 V	(-0 % / +15 %) of reading ± 10 digits
20.0 ÷ 99.9 V		(-0 % / +15 %) of reading

The accuracy is valid if mains voltage is stable during the measurement and PE terminal is free of interfering voltages.

Test current: ..... max.  $0.5 \times I_{\Delta N}$

Limit contact voltage: ..... 50 V

Specified accuracy is valid for complete operating range.

### 3.13.3 Trip-out time

Complete measurement range corresponds to EN 61557 requirements.  
Maximum measuring times set according to selected reference for RCD testing.

Range	Resolution	Accuracy
0 ÷ 40 ms	1 ms	±1 ms
0 ÷ 500 ms	1 ms	±3 ms

Test current .....  $\frac{1}{2} \times I_{\Delta N}$ ,  $I_{\Delta N}$ ,  $2 \times I_{\Delta N}$ ,  $5 \times I_{\Delta N}$

$5 \times I_{\Delta N}$  is not available for  $I_{\Delta N} = 1000$  mA (RCD type AC) or  $I_{\Delta N} \geq 300$  mA (RCD types A, B\*).

$2 \times I_{\Delta N}$  is not available for  $I_{\Delta N} = 1000$  mA (RCD type A) or  $I_{\Delta N} \geq 300$  mA (RCD type B\*).

$1 \times I_{\Delta N}$  is not available for  $I_{\Delta N} = 1000$  mA (RCD type B\*).

Specified accuracy is valid for complete operating range.

### 3.13.4 Trip-out current

#### Trip-out current

Complete measurement range corresponds to EN 61557 requirements.

Range	Resolution	Accuracy
$0.2 \times I_{\Delta N} \div 1.1 \times I_{\Delta N}$ (AC type)	$0.05 \times I_{\Delta N}$	$\pm 0.1 \times I_{\Delta N}$
$0.2 \times I_{\Delta N} \div 1.5 \times I_{\Delta N}$ (A type, $I_{\Delta N} \geq 30$ mA)	$0.05 \times I_{\Delta N}$	$\pm 0.1 \times I_{\Delta N}$
$0.2 \times I_{\Delta N} \div 2.2 \times I_{\Delta N}$ (A type, $I_{\Delta N} < 30$ mA)	$0.05 \times I_{\Delta N}$	$\pm 0.1 \times I_{\Delta N}$
$0.2 \times I_{\Delta N} \div 2.2 \times I_{\Delta N}$ (B type)*	$0.05 \times I_{\Delta N}$	$\pm 0.1 \times I_{\Delta N}$

#### Trip-out time

Range	Resolution	Accuracy
0 ÷ 300 ms	1 ms	±3 ms

#### Contact voltage

Range	Resolution	Accuracy
0.0 ÷ 19.9 V	0.1 V	(-0 % / +15 %) of reading ± 10 digits
20.0 ÷ 99.9 V	0.1 V	(-0 % / +15 %) of reading

The accuracy is valid if mains voltage is stable during the measurement and PE terminal is free of interfering voltages.

Trip-out measurement is not available for  $I_{\Delta N} = 1000$  mA (RCD type A and type B\*).

Specified accuracy is valid for complete operating range.

### 3.14 Fault loop impedance

#### 3.14.1 Zs

##### Fault loop impedance

Measuring range according to EN61557 is 0.25  $\Omega$  ÷ 9.99k $\Omega$ .

Range ( $\Omega$ )	Resolution ( $\Omega$ )	Accuracy
0.00 ÷ 9.99	0.01	±(5 % of reading + 5 digits)
10.0 ÷ 99.9	0.1	
100 ÷ 1999	1	± 10 % of reading

##### Prospective fault current (calculated value)

Measuring range (A)	Resolution (A)	Accuracy
0.00 ÷ 9.99	0.01	Consider accuracy of fault loop resistance measurement
10.0 ÷ 99.9	0.1	
100 ÷ 999	1	
1.00k ÷ 9.99k	10	
10.0k ÷ 23.0k	100	

The accuracy is valid if mains voltage is stable during the measurement.

Test current (at 230 V):..... 6.5 A (10 ms)

Nominal voltage range:..... 30 V ÷ 500 V (45 Hz ÷ 65 Hz)

Pass limits: ..... Appendix C

Test terminals:

Zs	TP1 test socket
----	-----------------

#### 3.14.2 Zs(rcd), Rs(rcd)

##### Fault loop impedance

Measuring range according to EN61557 is 0.46  $\Omega$  ÷ 9.99 k $\Omega$ .

Measuring range ( $\Omega$ )	Resolution ( $\Omega$ )	Accuracy
0.00 ÷ 9.99	0.01	±(5 % of reading + 10 digits)
10.0 ÷ 99.9	0.1	
100 ÷ 1999	1	± 10 % of reading

Accuracy may be impaired in case of heavy noise on mains voltage

##### Prospective fault current (calculated value)\*

Measuring range (A)	Resolution (A)	Accuracy
0.00 ÷ 9.99	0.01	Consider accuracy of fault loop resistance measurement
10.0 ÷ 99.9	0.1	
100 ÷ 999	1	
1.00k ÷ 9.99k	10	
10.0k ÷ 23.0k	100	

\* in Zs(rcd) only



Nominal voltage range:..... 50 V ÷ 500 V (45 Hz ÷ 65 Hz)

No trip out of RCD.

Pass limits: ..... Appendix C

Test terminals:

Zs(rcd), Rs(rcd)	TP1 test socket
------------------	-----------------

### 3.14.3 High precision fault loop impedance Z mΩL-Pe

Measuring range according to EN61557: 12.0 ÷ 19.99 Ω

Measuring range (mΩ)	Resolution (mΩ)	Accuracy
0.0 ÷ 199.9	0.1	±(5 % + 3 mΩ)
200 ÷ 1999	1	

Nominal voltage range:..... 100 V ÷ 440 V

Nominal frequency:..... 50 Hz

Maximum test current (at 230 V):.... 154 A (10 ms)

Calculation of prospective short-circuit current (standard voltage value):

$$I_k = \frac{230 \text{ V}}{Z} \quad U_{L-PE} = 230 \text{ V} \pm 10 \%$$

Calculation of prospective short-circuit current (non-standard voltage value):

$$I_{kMAX(L-PE)} = \frac{C_{MAX} \times U_{N(L-PE)}}{Z_{L-PE}} \quad I_{kMIN(L-PE)} = \frac{C_{MIN} \times U_{N(L-PE)}}{Z_{(L-PE)HOT}}$$

$$Z_{L-PE} = \sqrt{R_{L-PE}^2 + X_{L-PE}^2} \quad Z_{(L-PE)HOT} = \sqrt{(1.5 \times R_{L-PE})^2 + X_{L-PE}^2}$$

	$U_N(L-PE) = 230 \text{ V} \pm 10 \%$	$230 \text{ V} < U_N < 400 \text{ V}$
$C_{MAX}$	1.05	1.10
$C_{MIN}$	0.95	1.00

Test terminals:

Z mΩL-Pe	A1143: P1, P2, C1, C2
----------	-----------------------

### 3.14.4 Contact voltage

Measuring range (V)	Resolution (V)	Accuracy
0 ÷ 100	1	±(10 % + 3 digits)

Test terminals:

High precision impedance + contact voltage	A1143: P1, P2, C1, C2, S
--	--------------------------

### 3.15 Line impedance

#### Line impedance

Measuring range according to EN61557 is 0.25 Ω ÷ 9.99 kΩ.

Measuring range (Ω)	Resolution (Ω)	Accuracy
0.00 ÷ 9.99	0.01	±(5 % of reading + 5 digits)
10.0 ÷ 99.9	0.1	
100 ÷ 1999	1	± 10 % of reading

#### Prospective short-circuit current (calculated value)

Measuring range (A)	Resolution (A)	Accuracy
0.00 ÷ 0.99	0.01	Consider accuracy of line resistance measurement
1.0 ÷ 99.9	0.1	
100 ÷ 999	1	
1.00k ÷ 99.99k	10	
100k ÷ 199k	1000	

Test current (at 230 V):..... 6.5 A (10 ms)

Nominal voltage range:..... 30 V ÷ 500 V (45 Hz ÷ 65 Hz)

Pass limits: ..... See Appendix C

Test terminals:

Z LINE	TP1 test socket
--------	-----------------

#### 3.15.1 High precision line impedance

Measuring range according to EN61557 is 12.0 ÷ 1999 mΩ

Measuring range (mΩ)	Resolution (mΩ)	Accuracy
0.1 ÷ 199.9	0.1	±(5 % + 3 mΩ)
200 ÷ 1999	1	

Nominal voltage range:..... 100 V ÷ 440 V

Nominal frequency:..... 50 Hz

Maximum test current (at 400V):..... 267 A (10 ms)

Calculation of prospective short-circuit current (standard voltage value):

$$I_k = \frac{230 \text{ V}}{Z} \quad U_{L-N} = 230 \text{ V} \pm 10 \%$$

$$I_k = \frac{400 \text{ V}}{Z} \quad U_{L-L} = 400 \text{ V} \pm 10 \%$$

Calculation of prospective short-circuit current (non-standard voltage value):

$$I_{KMAX\ 3ph} = \frac{C_{MAX} \times U_{N(L-L)}}{\sqrt{3}} \times \frac{2}{Z_{L-L}}$$

$$I_{KMIN\ 3ph} = \frac{C_{MIN} \times U_{N(L-L)}}{\sqrt{3}} \times \frac{2}{Z_{(L-L)HOT}}$$

$$I_{KMAX\ 2ph} = \frac{C_{MAX} \times U_{N(L-L)}}{Z_{L-L}}$$

$$I_{KMIN\ 2ph} = \frac{C_{MIN} \times U_{N(L-L)}}{Z_{(L-L)HOT}}$$

$$I_{KMAX(L-N)} = \frac{C_{MAX} \times U_{N(L-N)}}{Z_{L-N}}$$

$$I_{KMIN(L-N)} = \frac{C_{MIN} \times U_{N(L-N)}}{Z_{(L-N)HOT}}$$

$$Z_{L-L} = \sqrt{R_{L-L}^2 + X_{L-L}^2}$$

$$Z_{(L-L)HOT} = \sqrt{(1.5 \times R_{L-L})^2 + X_{L-L}^2}$$

$$Z_{L-N} = \sqrt{R_{L-N}^2 + X_{L-N}^2}$$

$$Z_{(L-N)HOT} = \sqrt{(1.5 \times R_{L-N})^2 + X_{L-N}^2}$$

	U <sub>N(L-N)</sub> = 230 V ± 10 % U <sub>N(L-L)</sub> = 400 V ± 10 %	230 V < U <sub>N</sub> < 400 V
C <sub>MAX</sub>	1.05	1.10
C <sub>MIN</sub>	0.95	1.00

Test terminals:

High precision impedance	A1143: P1, P2, C1, C2
--------------------------	-----------------------

### 3.16 Voltage, frequency, and phase rotation

#### 3.16.1 Phase rotation

Result displayed	1.2.3 or 3.2.1
------------------	----------------

Nominal system voltage range: 100 V<sub>AC</sub> ÷ 550 V<sub>AC</sub>  
 Nominal frequency range:..... 14 Hz ÷ 500 Hz

Test terminals:

Phase rotation	TP1 test socket
----------------	-----------------

#### 3.16.2 Voltage, Frequency

Range	Resolution	Accuracy
0 ÷ 550 V	1 V	±(2 % of reading + 2 digits)

Range (Hz)	Resolution (Hz)	Accuracy
0.0, 14.0 ÷ 499.9	0.1	±(0.2 % of reading + 1 digit)

Result type:..... True r.m.s. (trms)  
 Nominal frequency range:..... 0 Hz, 14 Hz ÷ 500 Hz  
 Nominal voltage range:..... 10 V ÷ 550 V

Test terminals:

VOLTAGE	TP1 test socket
---------	-----------------

### 3.17 General data

#### Power supply

Rated supply voltage: ..... 115 V / 230 V AC  
 Supply voltage tolerance: .....  $\pm 10\%$   
 Frequency of supply voltage: .... 50 Hz, 60 Hz  
 Max. power consumption: ..... 300 VA (without DUT)  
 Rated DUT: ..... 16 A resistive, 1.5 kW motor

#### Overvoltage category

Instrument: ..... Cat II / 300 V  
 Test socket: ..... Cat II / 300 V  
 TP1 test socket: ..... Cat III / 300 V  
 Plug test cable: ..... 300 V CAT II  
 Universal test cable: ..... 300 V CAT III  
 Altitude: .....  $\leq 2000$  m

#### Protection classification

HV output: ..... Class I  
 TP1 test socket: ..... Class II, double insulation  
 Power supply: ..... Class I  
 Pollution degree: ..... 2  
 Degree of protection: ..... IP 50 (closed and locked cover)  
 ..... IP 20 main test socket  
 Case: ..... shock proof plastic / portable

Display: ..... 240\*128 dots graphic matrix display with backlight  
 Memory: ..... 6000 memory locations

#### Communication interface

RS232 interfaces: ..... 1200 bps ÷ 115200 bps, 1 start bit, 8 data bits, 1 stop bit  
 RS232 connectors: ..... 9-pin sub miniature type D, female  
 PRINTER1 connector: ..... customized for use with customized label printer

USB interface: ..... 1200 bps ÷ 115200 bps  
 USB connector: ..... type B

#### Insulation:

Communication ports to PE: ..... 600 k $\Omega$ , 5 %

Dimensions (w×h×d): ..... 33.5 cm × 16.0 cm × 33.5 cm  
 Weight  
 (with standard accessories): ..... 8.4 kg

#### Reference conditions

Reference temperature range: .. 15 °C ÷ 35 °C  
 Reference humidity range: ..... 35 % ÷ 65 % RH

**Operation conditions**

Working temperature range: ..... 0 °C ÷ +40 °C

Maximum relative humidity: ..... 85 % RH (0 °C ÷ 40 °C), non-condensing

**Storage conditions**

Temperature range: ..... -10 °C ÷ +60 °C

Maximum relative humidity: ..... 90 % RH (-10 °C ÷ +40 °C)

80 % RH (40 °C ÷ 60 °C)

Accuracies apply for 1 year in reference conditions. Temperature coefficient outside these limits is 0.2 % of measured value per °C plus 1 digit, otherwise noted.

**Fuses**

Test socket protection: ..... 2 x T16 A / 250 V, 6.3 × 32 mm

## 4 Main menu and test modes

The MultiservicerXA instrument has a user-friendly manipulation. By pressing only a few keys most of the actions can be done. The menu tree of the instrument has been designed to be simple to understand and easy to operate.

The instrument can test electrical equipment in four operating modes:

- PAT testing operating mode,
- Machine testing operating mode,
- Switchgear testing operating mode,
- All tests operating mode.

### 4.1 Help menus

The measurement help menus are available in single and autotest modes. They can be accessed with the key HELP before the START key is pressed to initiate the measurement.

Help menus contain schematic diagrams for illustration of proper connection of DUT to the PAT testing instrument.

Keys in help menu:

<b>PgUp</b> (F1) / <b>PgDown</b> (F2)	Selects next / previous help screen.
<b>ESC</b>	Returns to the last test / measurement menu.

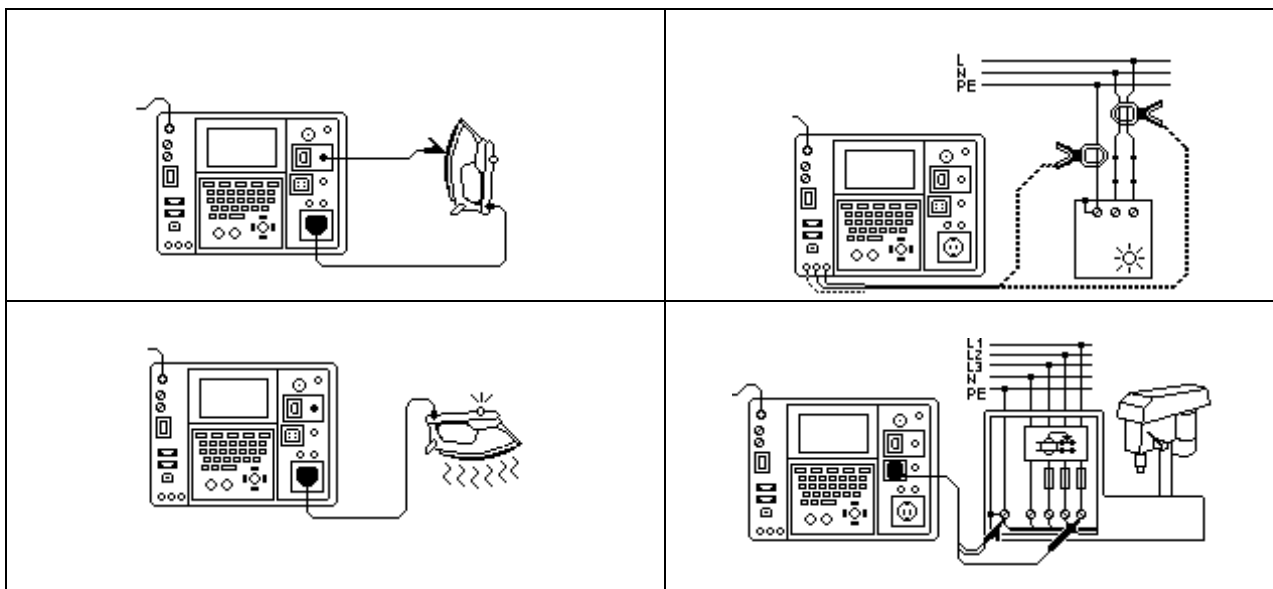

Example of help screens

## 4.2 Instrument main menu

From the *Instrument main menu* four different instrument operation menus and the General Settings menu can be set:

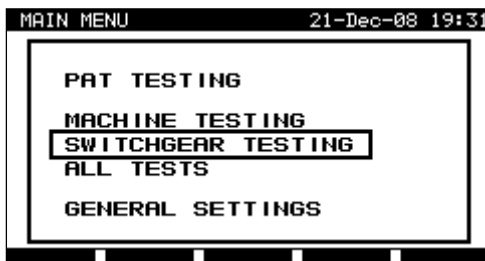

*Instrument main menu*

Keys in instrument main menu:

▲ / ▼	Select one of the following menu items: <PAT TESTING>, a group of tests intended for testing electrical devices, see <i>chapter 5</i> ; <MACHINE TESTING>, a group of tests intended for testing electrical equipment of machine, see <i>chapter 9</i> ; <SWITCHGEAR TESTING>, a group of tests intended for testing switchgear units, see <i>chapter 10</i> ; <ALL TESTS>, all tests can be applied for testing of electrical equipment, see <i>chapter 11</i> ; <GENERAL SETTINGS> the menu for general settings of the instrument, see <i>chapter 4.3</i> ;
ENTER	Confirms selection.
ESC	Returns to the <i>Instrument main menu</i> .

### Note:

- The ESC key must be pressed more than once to return to *Instrument main menu* from any submenu or selected function.

## 4.3 General settings menu

In the *General settings menu* the parameters of the instrument that are considered for all operating modes, can be viewed or set.

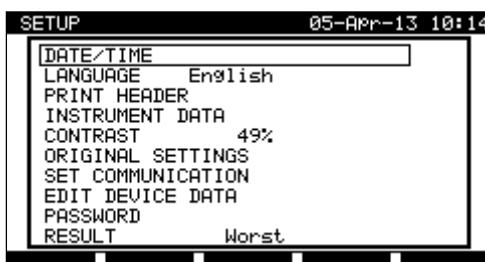

*Setup menu*

Keys in General settings menu:

▲ / ▼	Select the setting to adjust or view: <DATE/TIME>, day and time; <LANGUAGE>, instrument language; <PRINT HEADER>, printed header options; <INSTRUMENT DATA>, various instrument settings; <CONTRAST>, LCD contrast; <ORIGINAL SETTINGS>, factory settings; <SET COMMUNICATION>, communication options; <EDIT DEVICE DATA>, data for tested equipment ; <PASSWORD>, to access restricted options; <RESULT>, to access menu for setting considered result.
ENTER	Confirms selection.
ESC	Returns to the <i>Instrument main menu</i> .

### 4.3.1 Setting date and time

Selecting this option will allow the user to set the date and time of the unit. The following menu will be displayed:

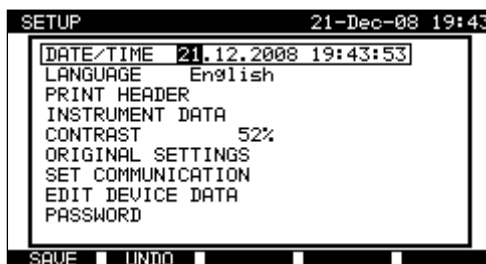

*Date and time menu*

Keys in date/time menu:

◀ / ▶	Select the field to be changed.
▲ / ▼	Modify selected field.
SAVE (F1)	Confirms selection and returns to <i>General settings menu</i> .
UNDO (F2) ESC	Discards modifications and returns to <i>General settings menu</i> .

#### Notes:

- ❑ Date is attached to each PAT autotest measurement results!
- ❑ Date format is DD-MM-YYYY (day-month-year).
- ❑ Date entry is checked for regularity and is not accepted in case of irregular date!

### 4.3.2 Language selection

Selecting this option will allow the user to select the language in the instrument. The following menu will be displayed:





Language menu

Keys in Language menu:

▲ / ▼	Select the language.
<b>ENTER</b>	Confirms selection and returns to <b>General settings menu</b> .
<b>ESC</b>	Discards modifications and returns to <b>General settings menu</b> .

### 4.3.3 Print header

Selecting this option will allow the user to set text of printing header. The print header is appended to printout form when test results are printed using a serial printer.

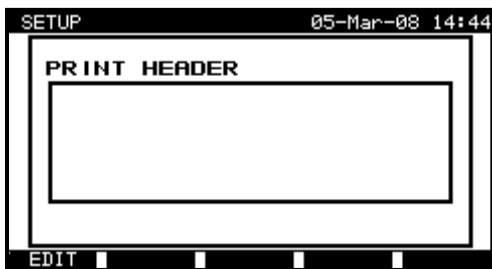

Print header menu

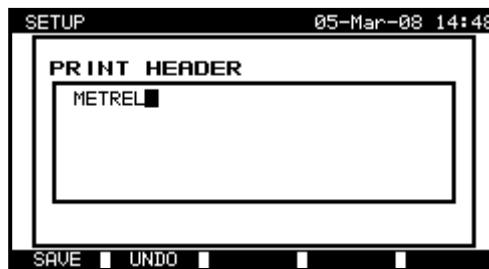

Editing print header

Keys in print header menu:

<b>EDIT (F1)</b>	Enters edit menu for entering print header.
<b>ESC</b>	Returns to <b>General settings menu</b> .

Keys in print header edit menu:

Alphanumeric keys	Entering header text
<b>SAVE (F1)</b>	Confirms selection and returns to <b>General settings menu</b> .
<b>UNDO (F2)</b> <b>ESC</b>	Discards modifications and returns to <b>General settings menu</b> .

### 4.3.4 Viewing of instrument data

In this menu the following instrument data are shown:

- Producer name,
- Instrument name,
- Calibration date,
- Serial number,

- Firmware version.

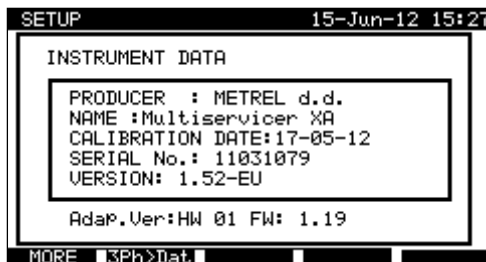

*Instrument data menu*

Keys in instrument data menu:

<b>MORE (F1)</b>	Switches between multiple screens.
<b>3Ph&gt;Dat (F2)</b>	Receives instrument data from 3-Phase adapter.
<b>ENTER ESC</b>	Returns to <b>General settings menu</b> .

**Note:**

- Operator cannot change any instrument data!

### 4.3.5 Display contrast adjustment

Selecting this option will allow the user to set LCD contrast. The following menu will be displayed:



*Contrast menu*

Keys in contrast menu:

<b>▲ / ▼</b>	Modify contrast.
<b>SAVE (F1)</b>	Confirms selection and returns to <b>General settings menu</b> .
<b>UNDO (F2) ESC</b>	Discards modifications and returns to <b>General settings menu</b> .

### 4.3.6 Reset instrument settings

In this menu the following parameters can be set to their initial values:

- All measurement parameters in single test mode,
- User defined tests are cleared,
- Custom autotest sequences are replaced by factory pre-programmed ones,
- PC baud rate is set to 115200 bps,
- Printer protocol is set to hardware handshaking – flow control (DTR).

The following menu is displayed:

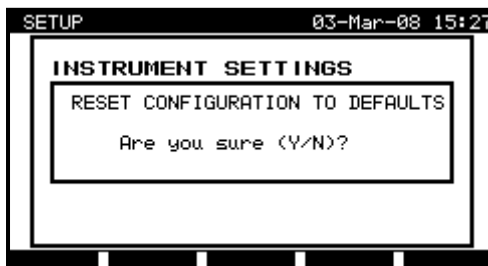

Original settings menu

Keys in instrument settings menu:

<b>Y</b>	Confirms reset to default values and returns to <b>General settings menu</b> .
<b>N</b>	Returns to <b>General settings menu</b> without reset.

### 4.3.7 Communication settings

In this menu, the communication port and baud rate can be set for communication with PC. Following menu will be displayed:

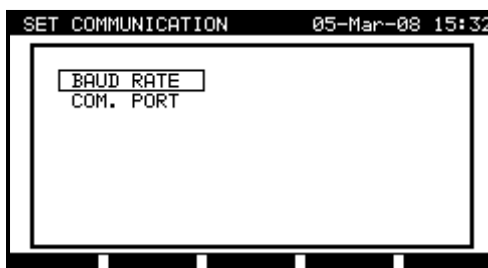

Communication menu

Keys in set communications menu:

<b>▲ / ▼</b>	Select the field to be changed.
<b>ENTER</b>	Confirms selection and opens menu of selected option.
<b>ESC</b>	Returns to <b>General settings menu</b> .

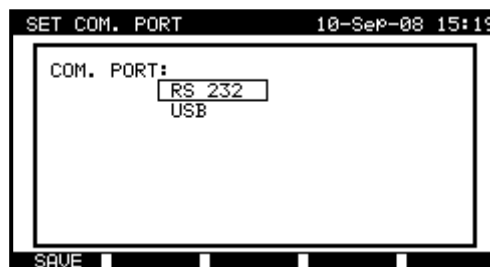
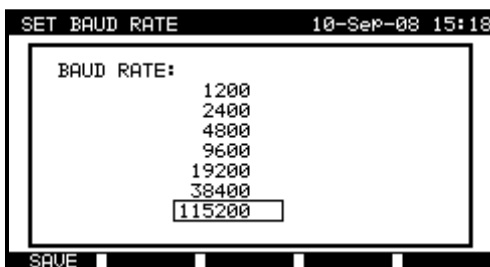

Communication settings

Keys in communications port and baud rate menus:

<b>▲ / ▼</b>	Select the proper option.
<b>SAVE (F1)</b>	Confirms selection and returns to <b>Set communications menu</b> .
<b>ESC</b>	Returns to <b>Set communications menu</b> without changes.

**Note:**

- Only one port can be active at one time.

### 4.3.8 Edit User / device data menu

Select **User / device data** in **General settings menu** with **▲** and **▼** keys and press **ENTER** key to confirm. The **User / device data** menu is displayed.

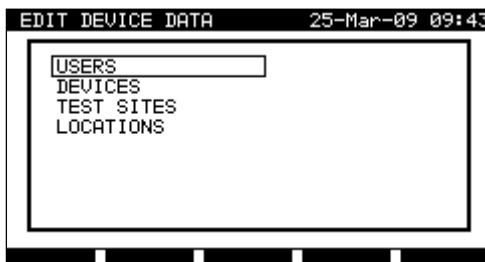

*User / device data main menu*

Keys in user / device data menu:

<b>▲ / ▼</b>	Select the field to be changed.
<b>ENTER</b>	Confirms selection and opens menu of selected item.
<b>ESC</b>	Returns to <b>General settings menu</b> .

#### 4.3.8.1 Users submenu

In this menu user names for up to 15 different users can be entered, edited and selected.

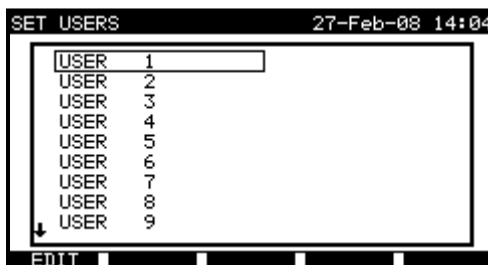

*Users submenu*

Keys in set users menu:

<b>▲ / ▼</b>	Select the user.
<b>ENTER</b>	Confirms selection and returns to <b>User / device data menu</b> .
<b>EDIT (F1)</b>	Confirms selection and opens <b>User edit menu</b> .
<b>ESC</b>	Discards modifications and returns to <b>User / device data menu</b> .

Keys in user edit menu:

Alphanumeric keys	Entering user name
<b>SAVE (F1)</b>	Confirms entry and returns to <b>User / device data menu</b> .
<b>UNDO (F2)</b> <b>ESC</b>	Discards modifications and returns to <b>User / device data menu</b> .

### 4.3.8.2 Devices submenu

In this menu, default lists of device names (up to 100) can be edited.  
 The list can be also downloaded to/ uploaded from the PC SW PATlinkPRO.  
 For more information refer to chapter 8.5 *Data upload / download*.

Select **Device** in **User / device data** menu by  $\wedge$  and  $\nabla$  keys and press ENTER key to confirm. The following menu is displayed:



Devices submenu

Keys in device menu:

$\wedge$ / $\nabla$ <b>PgUp</b> (F2) <b>PgDown</b> (F3)	Select the device.
<b>ENTER</b>	Confirms selection and returns to <b>User / device data menu</b> .
<b>EDIT</b> (F1)	Confirms selection and opens <b>Device edit menu</b> .
<b>ESC</b>	Discards modifications and returns to <b>User / device data menu</b> .

Keys in user edit menu:

Alphanumeric keys	Entering user name
<b>SAVE</b> (F1)	Confirms entry and returns to <b>User / device data menu</b> .
<b>UNDO</b> (F2) <b>ESC</b>	Discards modifications and returns to <b>User / device data menu</b> .

### 4.3.8.3 Test sites submenu

In this menu default lists of object names (up to 100) can be edited.  
 The list can be also downloaded to/ uploaded from the PC SW PATlinkPRO.  
 For more information refer to chapter 8.5 *Data upload / download*.

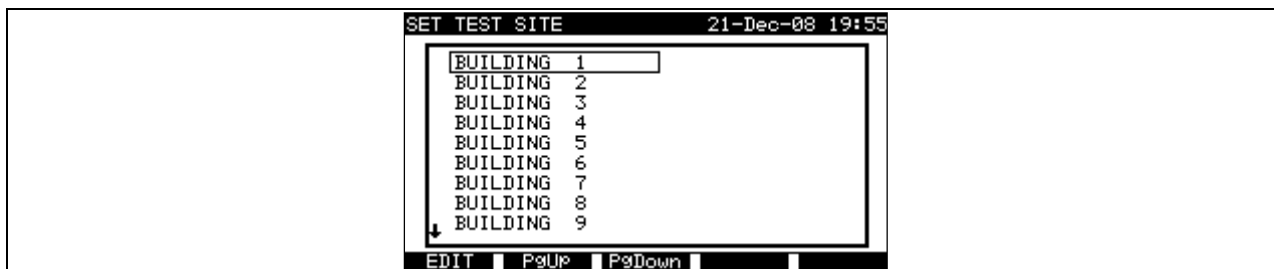

Test sites submenu

Keys in test sites menu:

▲ / ▼ <b>PgUp</b> (F2) <b>PgDown</b> (F3)	Select the test site.
<b>ENTER</b>	Confirms selection and returns to <i>User / device data menu</i> .
<b>EDIT</b> (F1)	Confirms selection and opens <i>Test site edit menu</i> .
<b>ESC</b>	Discards modifications and returns to <i>User / device data menu</i> .

Keys in user edit menu:

Alphanumeric keys	Entering test site name
<b>SAVE</b> (F1)	Confirms entry and returns to <i>User / device data menu</i> .
<b>UNDO</b> (F2) <b>ESC</b>	Discards modifications and returns to <i>User / device data menu</i> .

#### 4.3.8.4 Locations submenu

In this menu default lists of location names (up to 100) can be edited.  
The list can be also downloaded to/ uploaded from the PC SW PATlinkPRO.  
For more information refer to chapter 8.5 *Data upload / download*.

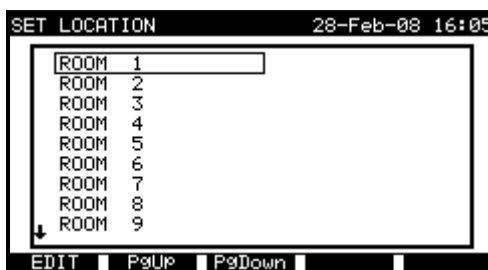

*Locations / rooms submenu*

Keys in device menu:

▲ / ▼ <b>PgUp</b> (F2) <b>PgDown</b> (F3)	Select the location.
<b>ENTER</b>	Confirms selection and returns to <i>User / device data menu</i> .
<b>EDIT</b> (F1)	Confirms selection and opens <i>Location edit menu</i> .
<b>ESC</b>	Discards modifications and returns to <i>User / device data menu</i> .

Keys in user edit menu:

Alphanumeric keys	Entering location name.
<b>SAVE</b> (F1)	Confirms entry and returns to <i>User / device data menu</i> .
<b>UNDO</b> (F2) <b>ESC</b>	Discards modifications and returns to <i>User / device data menu</i> .

### 4.3.9 Password

In password protected actions, it is necessary to enter the password before deleting or editing the protected data. The instrument requires a password and it will not allow changes unless the correct password has been entered.



*Password menu*

Keys in password menu:

Alphanumeric keys	Entering password.
<b>ENTER</b>	Accepts the password* and returns to <b>General settings menu</b> .
<b>ESC</b>	Discards modifications and returns to <b>General settings menu</b> .

Please take a note of this password and keep it in a safe place.

**\*Notes:**

- If there is no password protection, the instrument will request that you enter a new password twice, once to confirm.
- If the instrument is already password protected, then the instrument will request the old password before entering the new one twice, once to confirm.
- To disable the password protection, instead of entering a new password just press the ENTER key when asked for a new password and confirmation and the password will be disabled.

Contact your dealer if password is forgotten.

Password protected actions:

- Entering Edit user menu,
- Editing measurement parameters in single / autotest custom test mode,
- Deleting stored results,
- Entering Original settings menu.

### 4.3.10 Result

In this menu it can be set which result is displayed at the end of measurement



*Result setting menu*

Options in Result menu:

<b>Last</b>	The last result is displayed at the end of the measurement.
<b>Worst</b>	The worst result during the measurement is displayed at the end of the measurement.

Keys in Result menu:

▲ / ▼	Select Last or Worst option.
<b>SAVE (F1)</b>	Confirms selection and returns to <b>General settings menu</b> .
<b>UNDO (F2)</b> <b>ESC</b>	Discards modifications and returns to <b>General settings menu</b> .

**Note:**

- The last result of Voltage, Power and HV test is displayed at the end of measurement, regardless of settings in Result settings menu.



## 5 PAT testing operating mode

The PAT testing operating mode is primarily intended for periodic testing and maintenance of portable electrical appliances/devices and welding machines. The instrument can test devices in the following modes:

- Single test mode,
- Several autotest modes.

After the instrument is switched on, the last menu used will be displayed.

### Note:

- For testing 3-phases appliances and/or welding machines the 3-phase operation mode must be enabled and the MultiservicerXA must be connected to a Metrel A1322 or A1422 3-phase Active GT / Machine adapter (Plus).

### 5.1 PAT testing main menu

From the *PAT testing main menu* all instrument functions relevant for PAT testing can be selected.

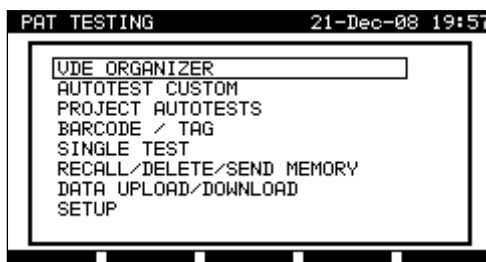

*PAT testing main menu*

Select the function you want to perform by using  $\uparrow$  and  $\downarrow$  keys and press ENTER key to confirm. To return to the previous menu press the ESC key.

### 5.2 VDE organizer menu

This menu offers creation and performing of VDE compatible test sequences. The sequence setup and its parameters are exactly the same as suggested in the VDE 0701-0702 standard.

When an autotest sequence has been created in the VDE organizer, it can be run as an autotest or stored in the Custom Autotest menu.

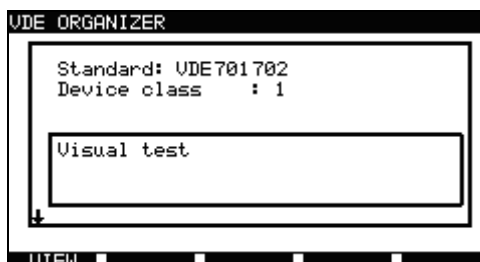

*VDE organizer menu*

See chapter 7.1 VDE organizer for more information.

### 5.3 Autotest custom menu

The menu contains a list of custom prepared autosequences.

Two sets (one for portable appliances and one for welding machines) of pre-programmed often used autotest sequences are added to the list by default.

Two sets of up to 50 custom autotest sequences can be pre-programmed in this autotest mode.

Custom autotests can be also downloaded to/ uploaded from the PC SW PATlinkPRO.



*Autotest custom menu  
– portable appliances*



*Autotest custom menu  
– welding machines*

See chapter 7 Autotest sequences for detailed description about this test mode.

#### Note:

- 3-Phase adapter A1422 combined with the MultiservicerXA instrument should be used for welding machine tests.

### 5.4 Project autotests menu

The Project autotest is a tool that simplifies and speeds up periodic testing of DUTs. The main idea is to re-use known and stored data about the DUT.



*Project autotest starting menu example*

See chapter 7.3 Project autotests for detailed description about this autotest mode.

### 5.5 Barcode / TAG menu

Barcode / TAG menu supports operation with barcodes and RFID tags.



Autotest barcode/ tag menu  
– portable appliances



Autotest barcode menu  
– welding machines

See chapter 7.4 Barcode/TAG menu for more information.

### 5.6 Single test menu

In single test menu individual tests can be performed. Two single test menus are available (one for portable appliances and one for welding machines).

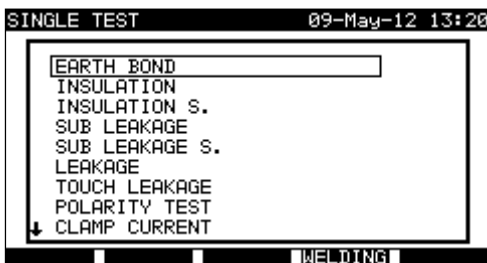

Single test menu  
– portable appliances

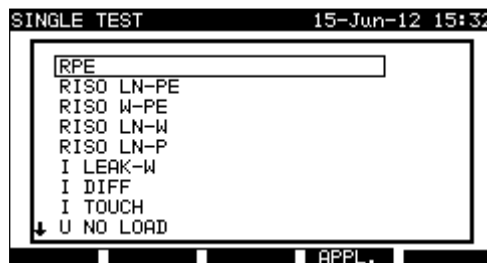

Single test menu  
– welding machines

See chapter 6 Single test mode for detailed description about the single test mode.

**Note:**

- 3-Phase adapter A1422 combined with the MultiservicerXA instrument should be used for welding machine tests.

### 5.7 Recall/ delete/ send results menu

Manipulation with stored data is allowed in this menu. Stored results can be recalled according to DUT name and date, deleted or send to PC or printers.

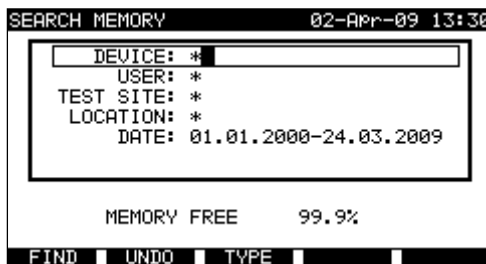

Recall results menu

See chapters 8.2 Recalling results, 8.3 Deleting results and 8.4 Downloading and printing results for more information.

## 5.8 Data upload / download menu

In this menu it is possible to upload different data from PC to the instrument:

- Stored test results and data (results, parameters, notes),
- List of default DUT and test site names,
- List of custom autosequences.



*Upload of test data menu*

See chapter 8.5 *Data upload / download* for detailed description about uploading / downloading data from or to a PC.

## 5.9 Setup menu

In this menu general instrument parameters specific for PAT testing mode can be set.

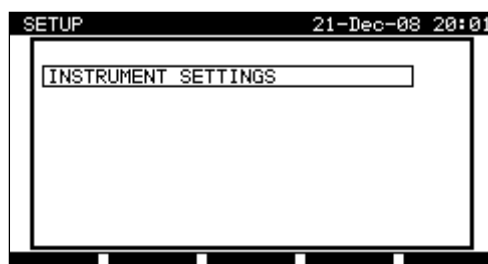

*Setup menu*

### 5.9.1 Instrument settings

When an autotest is completed, additional data about the DUT and comments can be appended to the autotest results before saving them. In the ***Instrument settings*** submenu, the settings as to how the data changes between tests can be controlled.

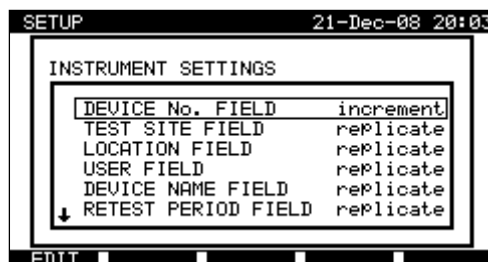

*Instrument settings menu*

The following data can be controlled between tests:

- Device number,
- Test site,
- Location,
- User,
- Device name,
- Retest period
- Repairing code,
- Comments,
- Barcode systems.

See chapter *8.6.1 Instruments settings* for more information.

## 6 Single tests in PAT testing mode

In the single test mode two sets of individual tests can be performed:

- Single tests for appliances,
- Single tests for welding machines.

This is especially helpful for troubleshooting.

### Note:

- Single test results cannot be saved in PAT testing operating mode.
- For testing 3-phase appliances or welding machines the 3-phase operation mode must be enabled and the MultiservicerXA must be connected to a Metrel 3-phase adapter:
  - A1322 – for 3-phase appliances,
  - A1422 – for 3-phase appliances and single phase or 3-phase welding machines.

### 6.1 Performing measurements in single test mode

Select **Single test** in **PAT testing main menu** by using  $\uparrow$  and  $\downarrow$  keys and press **ENTER** key to confirm. The **Single test menu** is displayed.

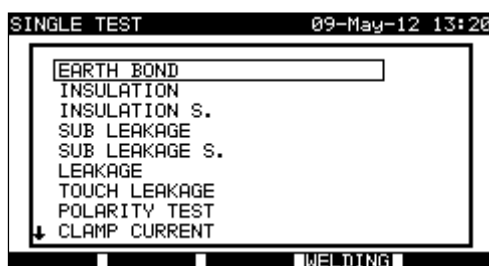

Single test menu  
– portable appliances

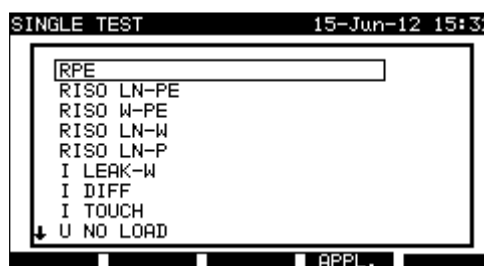

Single test menu  
– welding machines

Press (F4) **WELDING** or **APPL.** to switch between the two sets of single tests (if applicable).

In **Single test menu** select single test by using  $\uparrow$  and  $\downarrow$  keys and press **ENTER** key to confirm.

### Editing test parameters

Test measurement parameters of the selected single test are displayed in the top right corner of the display.

They can be edited by pressing the **EDIT(F1)** button and selected with by  $\uparrow$  and  $\downarrow$  keys. The selected parameter is highlighted. Its value can be set by using  $\leftarrow$  and  $\rightarrow$  keys.

### Note:

- To keep new settings, press **SAVE(F1)** key.

## 6.2 Measurements – Single tests for appliances

### 6.2.1 Earth bond resistance

This test ensures that the connections between the protective conductor terminal in the mains plug of the DUT and earthed accessible conductive parts of the DUT (metal housing) are satisfactory and of sufficiently low resistance. This test has to be performed on Class 1 (earthed) DUT.

The instrument measures the resistance between mains test socket's PE terminal/ PE terminal (only if test current of 200 mA is set) and S/C1 terminal.



*Earth bond menu*

#### Test parameters for earth bond resistance measurement

OUTPUT	Test current [200 mA, 10 A]
LIMIT	Maximum resistance [0.01 Ω ÷ 0.09 Ω, 0.1 Ω ÷ 0.9 Ω, 1 Ω ÷ 9 Ω]
TIME	Measuring time [5 s, 10 s, 30 s, 60 s, 120 s, 180 s]

#### Test circuit for earth bond resistance measurement

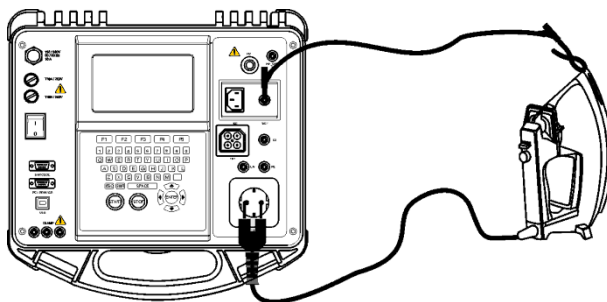

*Measurement of earth bond resistance of class I DUT*

#### Earth bond resistance measurement procedure

- Select the **EARTH BOND** function.
- Set test **parameters**.
- Connect** device under test to the instrument.
- Connect** test lead to S/C1 output on the instrument.
- Connect** S/C1 lead to accessible metal parts of the device under test (see figure above).
- Press the **START** key for measurement.

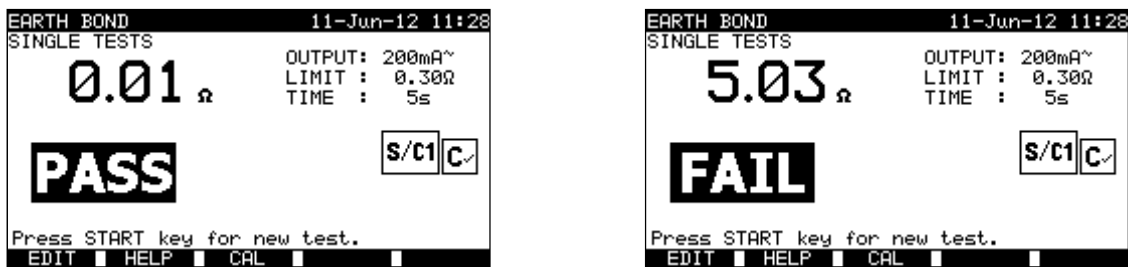

Examples of earth bond resistance measurement results

Displayed results:

Main result ..... earth bond resistance

**Note:**

- Consider displayed warnings before starting measurement!
- HW 4.x or higher :  
When PRCD test is enabled in autotest sequence then mains supply voltage is applied on test socket during earth bond test (if selected in autotest sequence).

### 6.2.1.1 Compensation of test leads resistance

Test leads compensation is required to eliminate the influence of test leads resistance and instrument's internal resistance. If a compensation value is stored this is indicated in the message **C**✓.

Compensation of test leads resistance procedure

- Select the **Earth Bond** function.
- Set test **parameters**.
- Connect** S/C1 test probe to the instrument and short it with PE pin of test socket.
- Press the CAL (F3)** key for measurement.
- If the calibration was performed successfully, **C**✓ is displayed.

**Notes:**

- 5.00 Ω is the limit value for resistance compensation. If the resistance is higher then the calibration value is reset to the default value and the compensation message disappears.
- Both 200 mA and 10 A earth bond functions are compensated at the same time.
- The lead compensation is very important to obtain correct results especially if long test leads are used.

### 6.2.2 Insulation resistance

The insulation resistance test checks the resistance between live conductors and earthed (or isolated) accessible metal parts of an DUT. This test can disclose faults caused by pollution, moisture, deterioration of insulation metal etc.

The instrument measures the insulation resistance between:

- Mains test socket (L+N) and PE / (S/C1) test terminals, and
- LN and PE / (S/C1) test outputs.



This function is primarily intended for testing Class I DUTs.



*Insulation menu*

### Test parameters for insulation resistance measurement

OUTPUT	<b>Test voltage</b> [250 V, 500 V]
LIMIT	<b>Minimum resistance</b> [0.10 MΩ, 0.30 MΩ, 0.50 MΩ, 1.00 MΩ, 2.00 MΩ, 4.00 MΩ, 7.00 MΩ, 10.00 MΩ, none]
TIME	<b>Measuring time</b> [5 s, 10 s, 30 s, 60 s, 120 s, none]

**Test circuits for insulation resistance measurement**

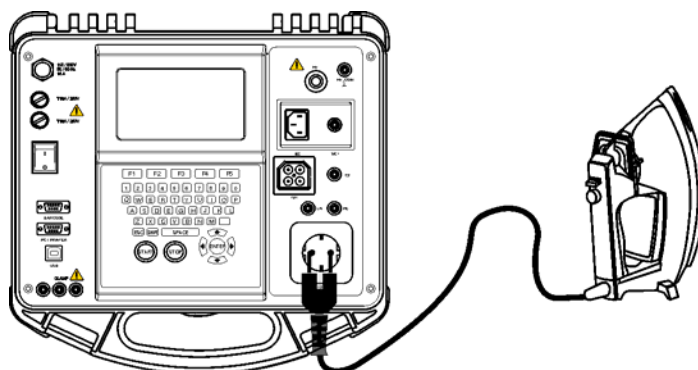

Measurement of insulation resistance of Class I DUT

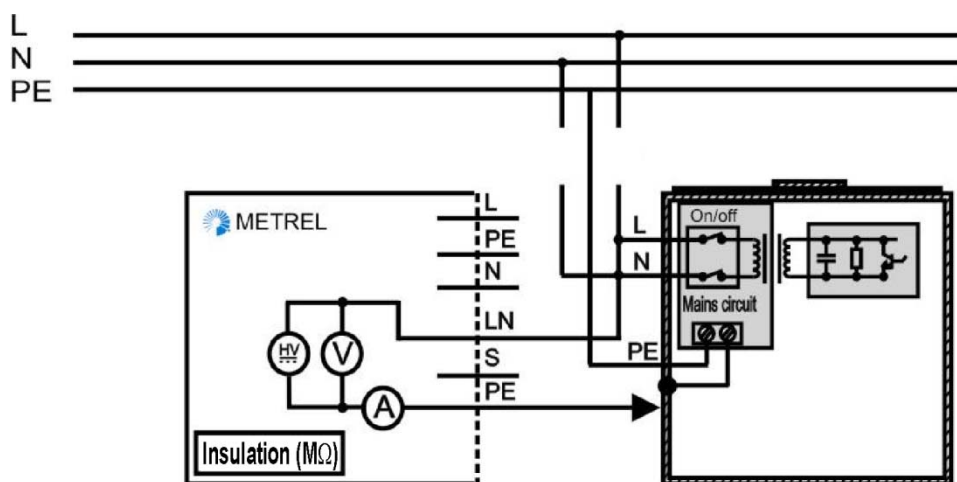

Measurement of insulation resistance of fixed installed DUTs of Class I

**Insulation resistance measurement procedure**

- Select the **Insulation** function.
- Set test **parameters**.
- Connect** device under test to the instrument (see figures above).
- For **fixed** equipment:
- Disconnect mains** supply of the fixed equipment;
- Connect** LN test socket of the instrument to L/N terminals of the fixed equipment;
- Connect** PE test socket of the instrument to metallic enclosure of the fixed equipment.
- Press the **START** key for measurement.



Examples of *insulation* resistance measurement results

Displayed results:  
Main result ..... Insulation resistance

**Notes:**

- Leakage currents into the S/C1 input will influence insulation resistance measurement.
- When S/C1 probe is connected during the test then the current through it is also considered.
- The DUT should be de-energized before the measurement!
- Consider any warning on the display before starting the measurement!
- Do not touch or disconnect the DUT during the measurement or before it is fully discharged! The message »Discharging...« will be displayed while the voltage on the DUT is higher than 20 V!

**6.2.3 Insulation resistance - S**

The insulation resistance test checks the resistance between live conductors and isolated accessible metal parts of DUT. This test can disclose faults caused by pollution, moisture, deterioration of insulation metal etc.

The instrument measures the insulation resistance between:

- Main test socket (L+N) and S/C1 test terminals, and
- LN and S/C1 test sockets.

This function is primarily intended for testing Class II DUTs and Class II parts of Class I DUTs.

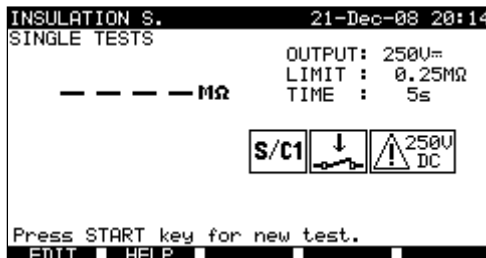

*Insulation S. menu*

**Test parameters for insulation resistance measurement**

OUTPUT	<b>Test voltage</b> [250 V, 500 V]
LIMIT	<b>Minimum resistance</b> [0.10 MΩ, 0.25 MΩ, 0.50 MΩ, 1.00 MΩ, 2.00 MΩ, 4.00 MΩ, 7.00 MΩ, 10.00 MΩ, none]
TIME	<b>Measuring time</b> [5 s, 10 s, 30 s, 60 s, 120 s, none]

## Test circuits for Insulation - S resistance measurement

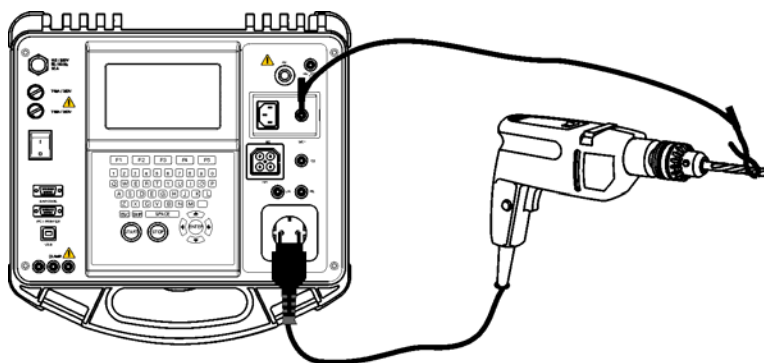

*Measurement of insulation resistance of class II DUT*

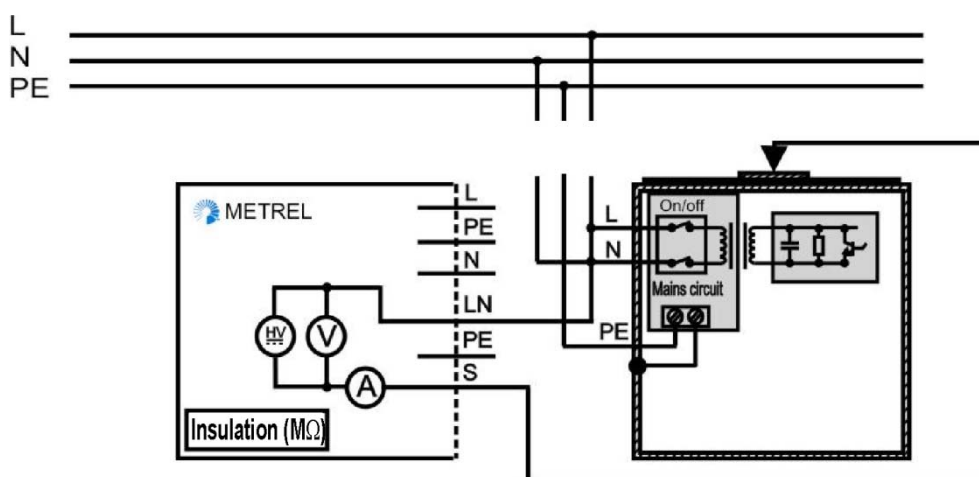

*Measurement of insulation resistance of accessible isolated conductive parts of fixed installed DUTs*

### Insulation resistance S measurement procedure

- Select the **Insulation resistance S** function.
- Set test **parameters**.
- Connect** device under test to the instrument (see figures above).
- Connect** S/C1 probe to accessible conductive parts of the DUT
- For **fixed equipment**:
- Disconnect mains** supply of the fixed equipment;
- Connect** LN test socket of the instrument to L/N terminals of the fixed equipment;
- Connect** S/C1 probe to accessible conductive parts of the fixed installed DUT
- Press the **START** key for measurement.

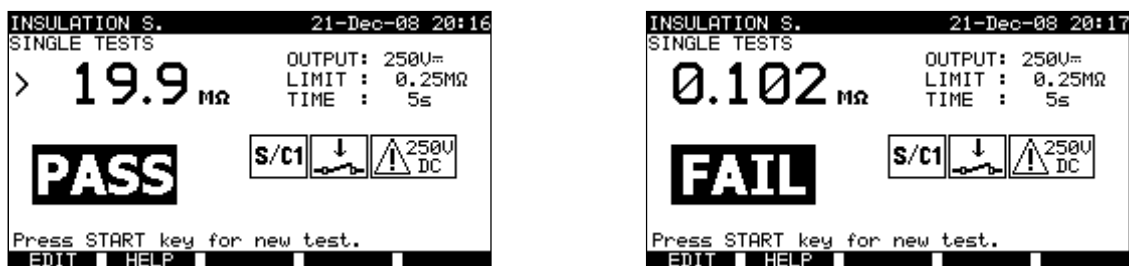

Example of insulation S. resistance measurement results

Displayed results:

Main result ..... Insulation resistance (LN – S)

**Notes:**

- If a Class I device is connected to the mains test socket the currents flowing through the PE terminal will not be considered.
- The DUT should be de-energized before the measurement!
- Consider any warning on the display before starting the measurement!
- Do not touch/ disconnect the DUT during the measurement or before it is fully discharged! The message »Discharging...« will be displayed while the voltage on the DUT is higher than 20 V!

**6.2.4 Substitute leakage current**

Leakage currents between live conductors and accessible metal parts (housing, screws, handles etc.) are checked with this test. Capacitive leakage paths are included in the result too. The test measures the current flowing at a test voltage of 40 VAC and the result is scaled to the value of a nominal mains supply voltage of 230 VAC.

The instrument measures the insulation resistance between:

- Main test socket (L+N) and PE / (S/C1) test terminals, and
- LN and PE / (S/C1) test sockets.

This function is primarily intended for testing Class I DUTs.



Sub leakage menu

**Test parameters for substitute leakage current measurement**

OUTPUT	Test voltage [40 V]
LIMIT	<b>Maximum current</b> [0.25 mA, 0.50 mA, 0.75 mA, 1.00 mA, 1.50 mA, 2.50 mA, 3.50 mA, 4.00 mA, 4.50 mA, 5.00 mA, 5.50 mA, 6.00 mA, 7.00 mA, 8.00 mA, 9.00 mA, none]
TIME	<b>Measuring time</b> [5 s, 10 s, 30 s, 60 s, 120 s, none]

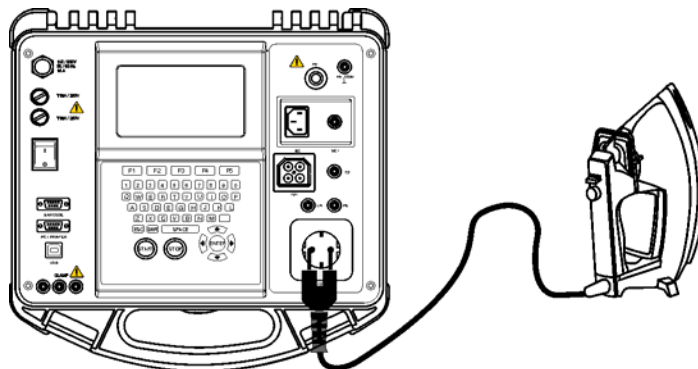

Measurement of substitute leakage current of class I DUT

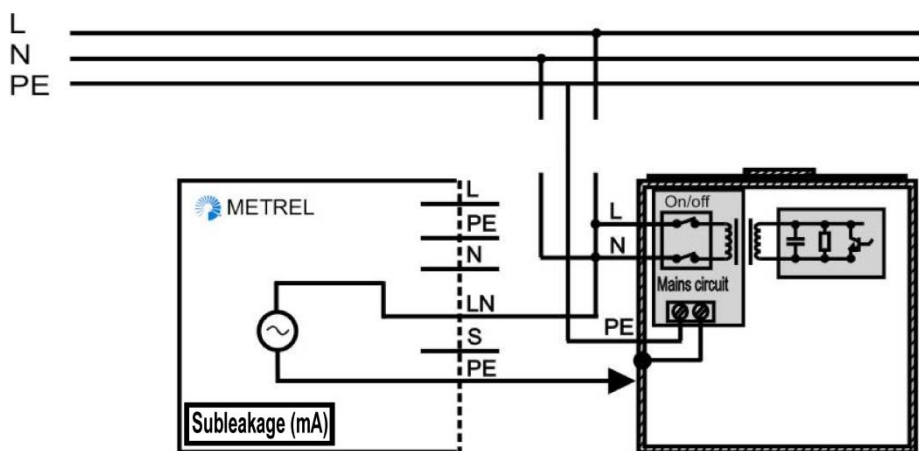

Measurement of substitute leakage current of fixed installed DUTs of class I

**Substitute leakage measurement procedure**

- Select the **Substitute leakage** function.
- Set test **parameters**.
- Connect** device under test to the instrument (see figures above).
- For **fixed equipment**:
- Disconnect mains** supply of the fixed equipment;
- Connect** LN test socket of the instrument to L/N terminals of the fixed equipment;
- Connect** PE test socket of the instrument to metallic enclosure of the fixed equipment.
- Press the **START** key for measurement.



Example of substitute leakage current measurement results

Displayed results:  
Main result ..... substitute leakage current

**Notes:**

- Consider any displayed warning before starting measurement!
- When S/C1 probe is connected during the test then the current through it is also considered.
- Substitute leakage current may differ substantially from that of conventional leakage current test because of the way the test is performed. For example, the difference in both leakage measurements will be affected by the presence of neutral to earth noise suppression capacitors.

**6.2.5 Substitute leakage - S**

Leakage currents between live conductors and isolated accessible metal parts (screws, handles etc.) are checked with this test. Capacitive leakage paths are included in the result too. The test measures the current flowing at a test voltage of 40 V AC and the result is scaled to the value of a nominal mains supply voltage of 230 V AC.

The instrument measures the insulation resistance between:

- Main test socket (L+N) and S/C1 test terminals, and
- LN and S/C1 test sockets.

This function is primarily intended for testing Class II DUTs and Class II parts of Class I DUTs.

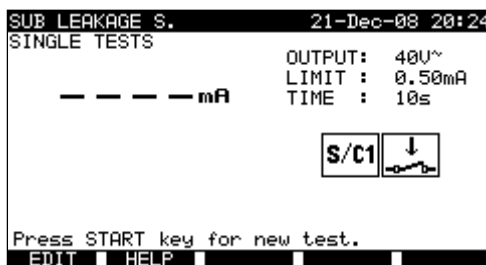

*Sub leakage S menu*

**Test parameters for substitute leakage S current measurement**

OUTPUT	Test voltage [40 V]
LIMIT	<b>Maximum current</b> [0.25 mA, 0.50 mA, 0.75 mA, 1.00 mA, 1.50 mA, 2.00 mA, 2.50 mA, 3.00 mA, 3.50 mA, none]
TIME	<b>Measuring time</b> [5 s, 10 s, 30 s, 60 s, 120 s, none]

**Test circuits for substitute leakage S measurement**

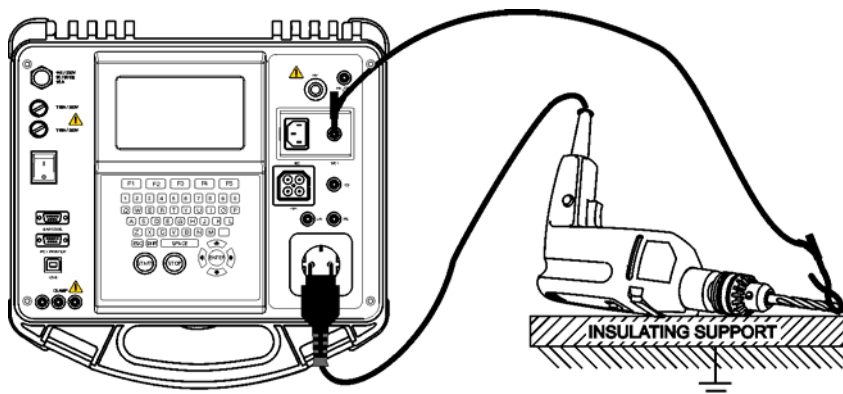

Measurement of substitute leakage current of class II DUT

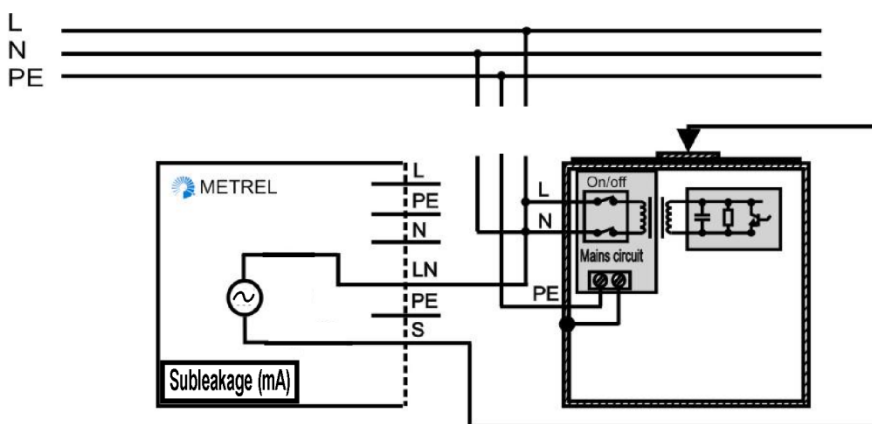

Measurement of substitute leakage of accessible isolated conductive parts of fixed installed DUTs

**Insulation resistance S measurement procedure**

- Select the **Substitute leakage S** function.
- Set test **parameters**.
- Connect** device under test to the instrument (see figures above).
- Connect** S/C1 probe to accessible conductive parts of the DUT.
- For **fixed equipment**:
- Disconnect** mains supply of the fixed equipment;
- Connect** LN test socket of the instrument to L/N terminals of the fixed equipment;
- Connect** S/C1 probe to accessible conductive parts of the fixed installed DUT
- Press the **START** key for measurement.

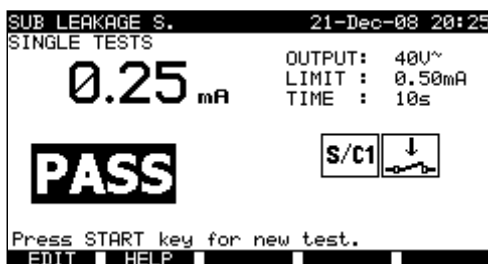

Example of substitute leakage S current measurement results



Displayed results:  
 Main result ..... substitute leakage current LN-S

**Notes:**

- Consider any displayed warning before starting measurement!
- If a Class I device is connected to the mains test socket the currents flowing through the PE terminal will not be considered.

**6.2.6 Differential leakage current**

The purpose of this test is to determine the sum of all leakages flowing from the live conductor to the earth. Because the differential method for determining leakage current is used the full and true DUT leakage current is always measured, even when parallel current paths to ground exist in the DUT.



*Differential leakage current menu*

**Test parameters for differential leakage current measurement**

OUTPUT	Test voltage [230 V]
LIMIT	<b>Maximum current</b> [0.25 mA, 0.50 mA, 0.75 mA, 1.00 mA, 1.50 mA, 2.50 mA, 3.50 mA, 4.00 mA, 4.50 mA, 5.00 mA, 5.50 mA, 6.00 mA, 7.00 mA, 8.00 mA, 9.00 mA, none]
TIME	<b>Measuring time</b> [5 s, 10 s, 30 s, 60 s, 120 s, none]

**Test circuit for differential current measurement**

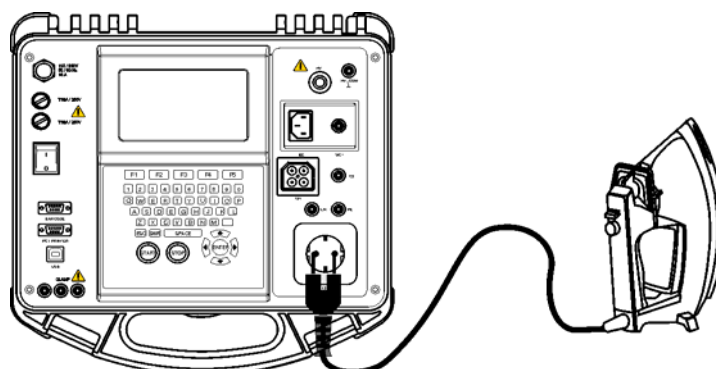

*Measuring of differential current*

**Differential current measurement procedure**

- Select the **Differential** function.
- Set test **parameters**.
- Connect** device under test to the instrument (see figure above).
- Press the **START** key for measurement.



*Examples of differential current measurement result*

Displayed results:

Main result ..... differential leakage current

**Notes:**

- During the test, a mains voltage is connected to the DUT. If DUT contains moving parts, make sure that it is safely mounted or protected to prevent possible danger to the operator or damage to the DUT or surrounding environment!
- Consider any displayed warning before starting measurement!
- The instrument automatically changes L and N polarity of connected DUT during the test.

**6.2.7 Touch leakage current**

This test determines the current that would flow if a person touches accessible conductive parts of the DUT.

The instrument measures the leakage current flowing through the S/C1 probe into earth. The DUT can be powered from the mains test socket or directly from the installation (fixed installed equipment).

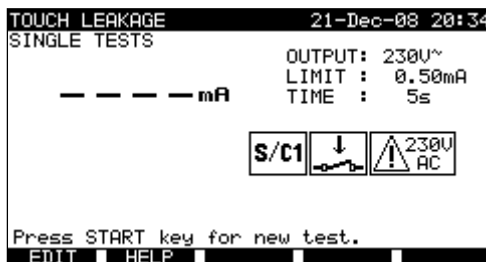

*Touch leakage menu*

**Test parameters for touch leakage current measurement**

OUTPUT	System voltage [230 V]
LIMIT	Maximum current [0.25 mA, 0.50 mA, 0.75 mA, 1.00 mA, 1.50 mA, 2.00 mA, none]
TIME	Measuring time [5 s, 10 s, 30 s, 60 s, 120 s, none]

**Test circuits for touch leakage current measurement**

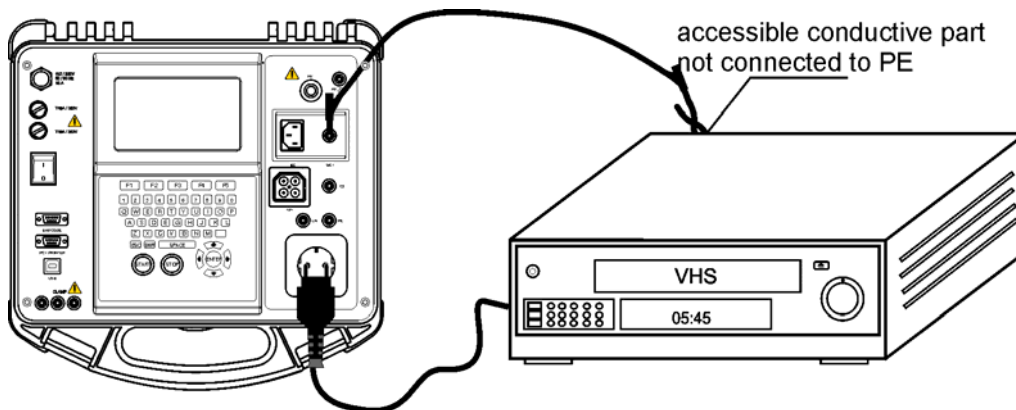

*Measurement of touch leakage current*

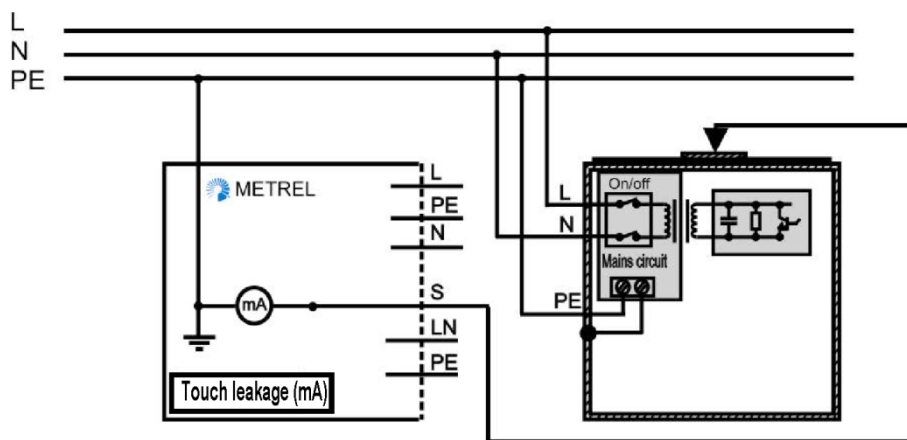

*Measurement of touch leakage current on a fixed installed DUT*

**Touch leakage current measurement procedure**

- Select the **Touch leakage** function.
- Set test **parameters**.
- Connect S/C1** probe to accessible conductive parts of the DUT (see figures above).
- For **Portable appliance/device**:
  - Connect** device under test to the instrument.
- For **fixed equipment**:
  - Power on** the fixed equipment;
- Press the **START** key for measurement.

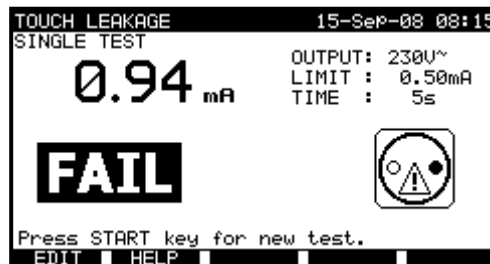
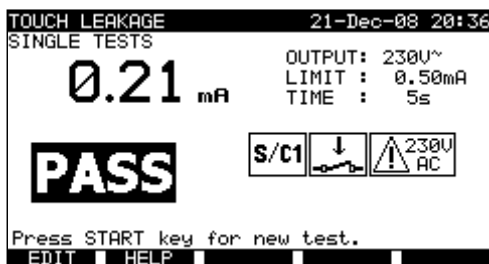

*Examples of touch leakage current measurement results*

Displayed results:  
Main result ..... touch leakage current

**Notes:**

- During the test, a mains voltage is connected to the DUT. If DUT contains moving parts, make sure that it is safely mounted or protected to prevent possible danger to the operator or damage to the DUT or surrounding environment!
- Consider any displayed warning before starting measurement!
- The instrument automatically changes L and N polarity of connected DUT during the test.

**6.2.8 Polarity test**

This test checks the polarity of a supply cords.  
In the Normal mode the test is performed with internal low voltage sources.  
The Active mode is intended to test cords/ leads with integrated RCD protection. Mains voltage is applied to the tested cord in order to operate the RCD during the test.  
The following faults can be detected: L open, N open, PE open, L-N crossed, L-PE crossed, N-PE crossed, L-N shorted, L-PE shorted, N-PE shorted, multiple faults.



*Polarity test menu*

**Test parameters for polarity test**

TEST	Type of polarity test [normal, active]
------	--

**Test circuit for polarity test**

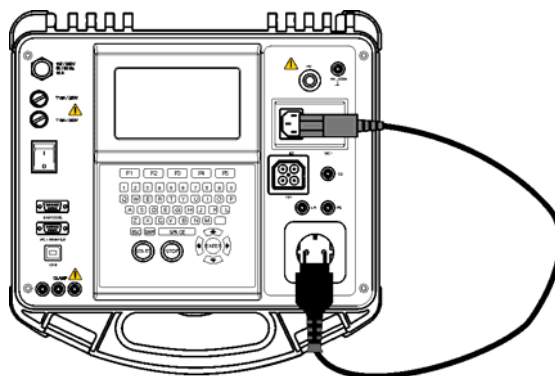

*Polarity test of IEC cord*

**Polarity - Standard test procedure**

- |  |
|--|
| <ul style="list-style-type: none"> <li><input type="checkbox"/> Select the <b>Polarity test</b> function.</li> <li><input type="checkbox"/> Select the <b>normal test</b> sub-function.</li> </ul> |
|--|

- Connect** tested IEC cord to the instrument (see figure above).
- Press the **START** key for measurement.

### Polarity - Active test procedure

- Select the **Polarity test** function.
- Select the **active test** sub-function.
- Connect** tested IEC cord with RCD protection to the 3 Phase adapter A1322 / A1422 (see A 1322 / A 1422 user manual).
- Press the **START** key for measurement.
- Switch ON** the appliance (RCD) within 5 seconds and follow the instructions on the display.
- Switch ON** the RCD again if necessary.



*Examples of polarity test result*

Displayed results:

Main result ..... PASS/ FAIL, description of fault

#### Notes:

- Consider any displayed warning before starting test!
- Active polarity test can only be performed with 3 Phase adapter (A1322 / A1422).
- Active polarity test is intended for testing RCD equipped cords where RCD must be supplied for proper operation.
- In the active polarity test a switchover between phase and neutral at the mains test socket is performed during the test. Although the switchover time is short it could happen that the RCD switches off during the switchover. In this case the warning 'SWITCH ON THE APPLIANCE' is displayed again and the RCD must be re-switched ON.

### 6.2.9 Clamp current test

This function enables the measurement of AC currents in a wide range from 1 mA up to 25 A with current clamps. Typical applications are:

- measuring PE leakage currents through PE conductor in permanently installed DUTs,
- measuring load currents in permanently installed DUTs,
- measuring differential leakage currents in permanently installed DUTs.



Clamp current menu

### Test parameters for clamp current measurement

LIMIT	<b>Maximum current</b> [0.25 mA, 0.50 mA, 0.75 mA, 1.00 mA, 1.50 mA, 2.25 mA, 2.50 mA, 3.00 mA, 3.50 mA, 5.00 mA, 9.00 mA]
TIME	<b>Measuring time</b> [5 s, 10 s, 30 s, 60 s, 120 s, none]

**Test circuit for clamp current measurement**

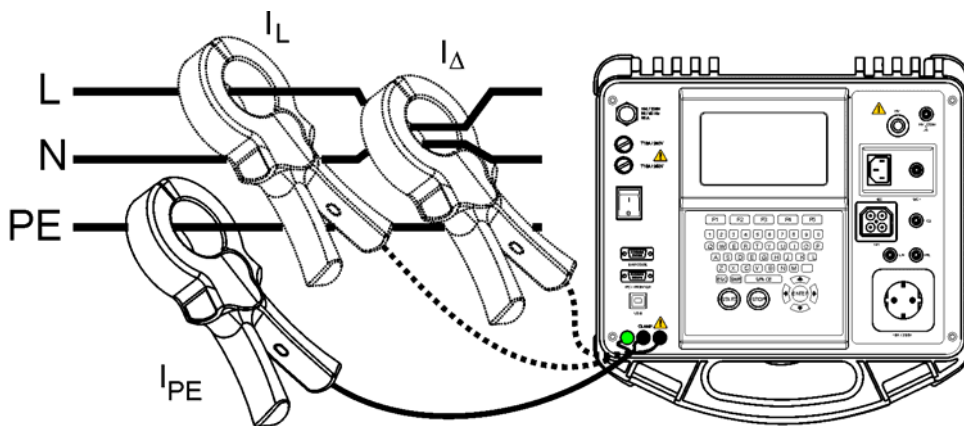

Connecting current clamp to the instrument

**Clamp current measurement procedure**

- Select the **Clamp current** function.
- Set test **parameters**.
- Connect** the current clamp to the instrument (see figure above).
- Embrace** wire(s) that has to be measured with current clamp.
- Press the **START** key for measurement.



Examples of clamp current measurement result

Displayed results:

Main result ..... clamp current

**Notes:**

- When measuring leakage currents, the neighboring magnetic fields and capacitive coupling (especially from the L and N conductors) can disturb the results. It is recommended that the clamp is as close as possible to the grounded surface and away from wires and other objects under voltage or carrying current.
- METREL offers high quality current clamps for this application.
- Green socket is intended for current clamp shield terminal, if exists. This will improve measurement of leakage current. The socket is connected to internal grounding system and through this to PE.

### 6.2.10 PRCD test

The purpose of this test is to ensure the proper operation of residual current devices built into a DUTs and portable residual current devices. Trip-out time measurement verifies the sensitivity of a PRCD at selected residual currents.

#### Test parameters for PRCD test

$I_{\Delta N}$	Rated PRCD residual current [10 mA, 15 mA, 30 mA]
MODE	Type of <b>PRCD test</b> [single, auto]

If Single mode is selected:

Multi	Actual test current $I_{\Delta N}$ [x 1/2, x 1, x 5]
Phase	<b>Starting angle</b> [0°, 180°, (0°,180°)]

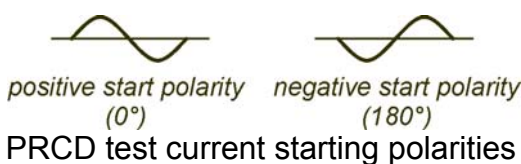

#### Trip-out time limits

Trip-out times according to EN 61540:

	$\frac{1}{2} \times I_{\Delta N}^*$	$I_{\Delta N}$	$5 \times I_{\Delta N}$
General RCDs (non-delayed)	$t_{\Delta} > 300$ ms	$t_{\Delta} < 300$ ms	$t_{\Delta} < 40$ ms

\* Minimum test period for current of  $\frac{1}{2} \times I_{\Delta N}$ , RCD shall not trip-out.

Maximum test times related to selected test current for general (non-delayed) RCD

Standard	$\frac{1}{2} \times I_{\Delta N}$	$I_{\Delta N}$	$5 \times I_{\Delta N}$
EN 61540	300 ms	300 ms	40 ms

#### Circuits for testing PRCD

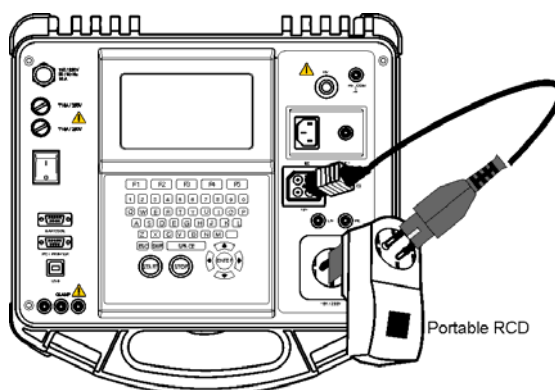

Testing of portable RCD (PRCD)



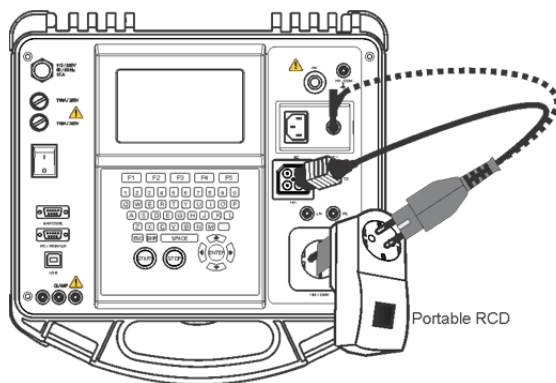

Testing of portable RCD (PRCD) using optional A 1447 adapter

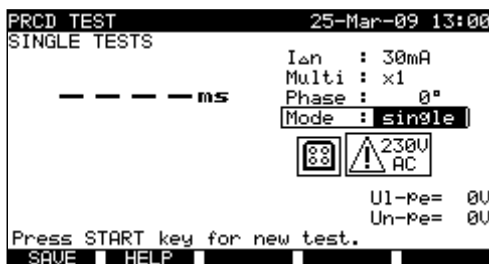

PRCD single test menu

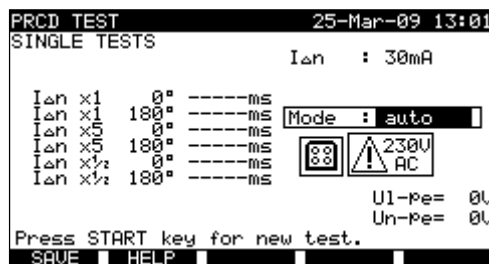

PRCD autotest menu

### 6.2.10.1 PRCD single test

#### Trip-out time measurement procedure

- Select the PRCD test function.
- Select Single test mode.
- Set test parameters.
- Connect tested PRCD/ device to an external voltage socket (see figure above). Depending on the type of PRCD, it may be necessary to manually switch the PRCD on.
- Connect test lead to TP1 test socket of the instrument and the PRCD's output.
- Press the START key to perform measurement.
- If both current polarities are selected:
  - Reactivate tested PRCD
  - Press the START key to perform measurement with opposite current polarity.

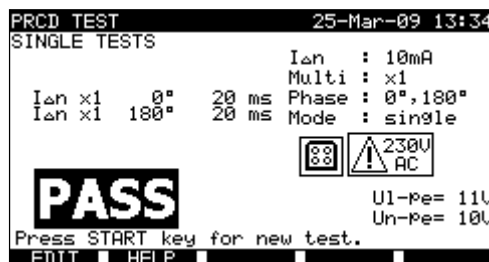
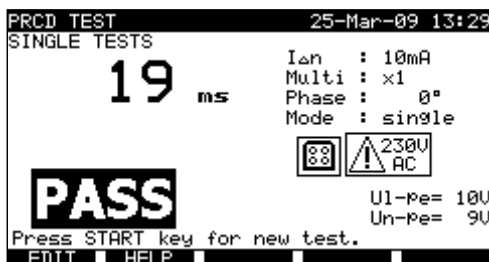

Examples of PRCD test result

Displayed results:

Main result ..... last measured results

Sub-results ..... all results are displayed as sub-results

UI-pe ..... voltage  $U_{L-PE}$

### 6.2.10.2 Automatic PRCD test

PRCD autotest function is intended to perform a complete PRCD analysis. (trip-out times at different residual currents and current phases) .

#### PRCD autotest procedure

PRCD Autotest steps	Notes
<input type="checkbox"/> Select the PRCD test function. <input type="checkbox"/> Set Auto test mode. <input type="checkbox"/> Select test parameters. <input type="checkbox"/> Connect tested PRCD device to an external voltage socket (see figure above). Depending on the type of PRCD, it may be necessary to manually switch the PRCD on. <input type="checkbox"/> Connect test lead to TP1 test socket of the instrument and the PRCD's output. <input type="checkbox"/> Press the START key.	Start of test
<input type="checkbox"/> Test with $I_{\Delta N}$ , $0^\circ$ (step 1).	PRCD should trip-out
<input type="checkbox"/> Re-activate PRCD. <input type="checkbox"/> Test with $I_{\Delta N}$ , $180^\circ$ (step 2).	PRCD should trip-out
<input type="checkbox"/> Re-activate PRCD. <input type="checkbox"/> Test with $5 \times I_{\Delta N}$ , $0^\circ$ (step 3).	PRCD should trip-out
<input type="checkbox"/> Re-activate PRCD. <input type="checkbox"/> Test with $5 \times I_{\Delta N}$ , $180^\circ$ (step 4).	PRCD should trip-out
<input type="checkbox"/> Re-activate PRCD. <input type="checkbox"/> Test with $\frac{1}{2} \times I_{\Delta N}$ , $0^\circ$ (step 5).	PRCD should not trip-out
<input type="checkbox"/> Test with $\frac{1}{2} \times I_{\Delta N}$ , $180^\circ$ (step 6).	PRCD should not trip-out End of test.

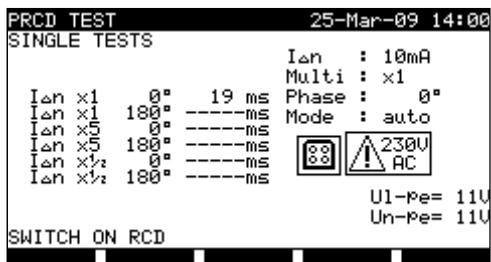

Step 1

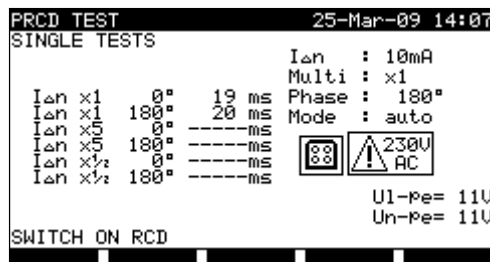

Step 2

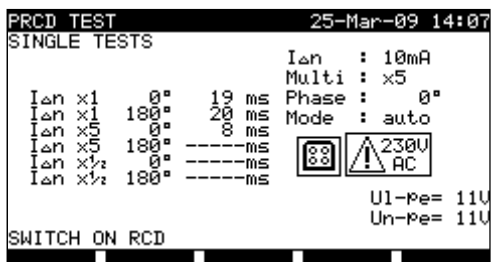

Step 3

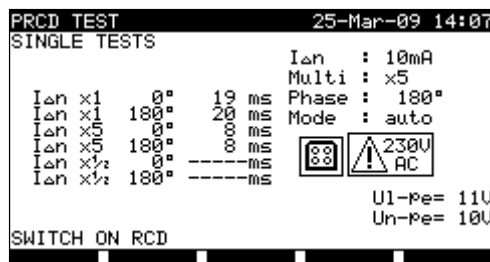

Step 4

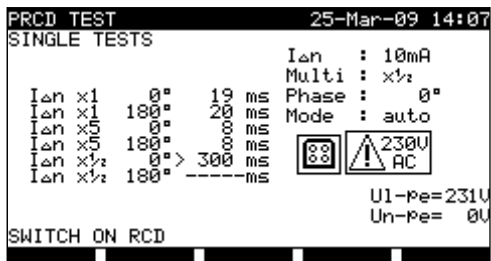

Step 5 and

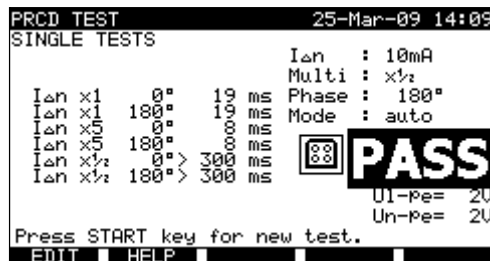

Step 6

Individual steps in PRCD autotest

The test passes if the PRCD:

- Does not trip out at  $\frac{1}{2} \times I_{\Delta N}$  tests,
- Trips inside predefined time limits at  $I_{\Delta N}$ , and  $5 \times I_{\Delta N}$  tests.

Displayed results:

Main result ..... last measured results

Sub-results ..... all results are displayed as sub-results

U1-pe ..... voltage UL-PE

Notes:

- Consider any displayed warning before starting measurement!
- For DUTs with integrated RCD the housing must be opened to access the RCD's L output terminal (this should only be performed by a competent engineer).
- Mains voltage is applied to the PRCD under test. Do not touch the equipment under test or the test leads during the test!
- HW 4.x or higher :  
When PRCD test is enabled in autotest sequence then mains supply voltage is applied on test socket during earth bond test (if selected in autotest sequence).

### 6.2.11 Power / Functional test

The DUT's power consumption is measured in this test. The apparent power is an useful indication of proper operation of the DUT.

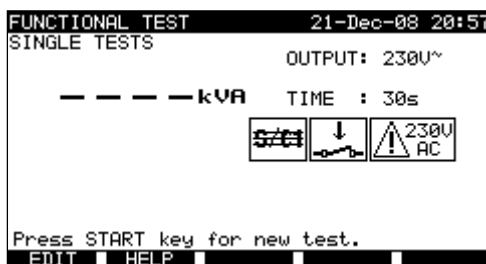

Power/functional test menu

#### Test parameters for the Power / Functional test

OUTPUT	System voltage [230 V]
TIME	Measuring time [5 s, 10 s, 30 s, 60 s, 120 s, none]

#### Circuit for the functional test

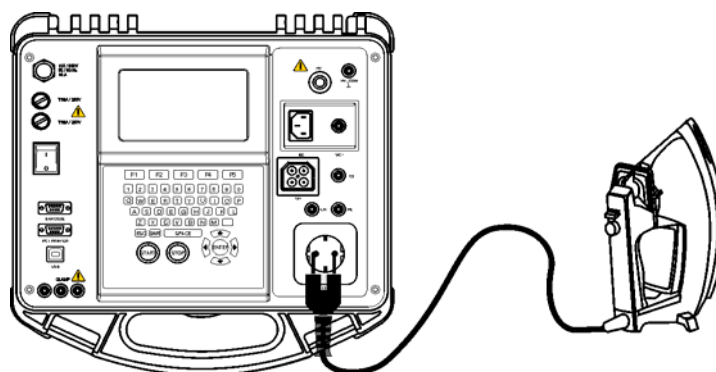

Functional test

#### Functional test procedure

- Select the **Functional test** function.
- Set measuring **time**.
- Connect** tested DUT to the instrument (see figure above).
- Press the **START** key for measurement.



Example of apparent power measurement result

Displayed results:

Main result ..... apparent power

**Notes:**

- During the test, a mains voltage is connected to the DUT. If DUT contains moving parts, make sure that it is safely mounted or protected to prevent possible danger to the operator or damage to the DUT or surrounding environment!
- Consider any displayed warning before starting measurement!

### 6.3 Measurements – Single tests for welding machines

**Note:**

- For testing welding machines the 3-phase operation mode must be enabled and the MultiservicerXA must be connected to a METREL 3-phase adapter (A1422).

#### 6.3.1 Continuity of the protective circuit

This test ensures that the connections between the protective conductor terminal in the mains plug of the DUT and earthed accessible conductive parts of the DUT (metal housing) are satisfactory and of sufficiently low resistance.

The instrument measures:

- the resistance between mains test socket’s PE terminal/ PE terminal (only if test current of 200 mA is set) and S/C1 terminal.
- the resistance between mains test socket’s PE terminal on 3-phase adapter and S/C1 terminal on MultiservicerXA.



Continuity menu

#### Test parameters for continuity measurement

OUTPUT	Test current [200 mA, 10 A]
LIMIT	Maximum resistance [0.10 Ω ÷ 0.90 Ω, 1.00 Ω]
TIME	Measuring time [5 s, 10 s, 30 s, 60 s, 120 s, 180 s]

#### Test circuit and measurement procedure for continuity measurement

For more information refer to chapter **Measurements according to IEC/ EN 60974-4**, paragraph **Continuity of the protective circuit** in 3-phase adapter user manual.

**Result screens:**

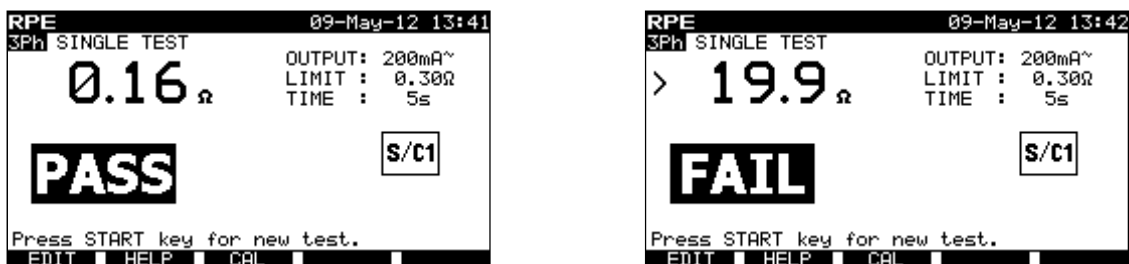

*Examples of continuity measurement results*

Displayed results:

Main result ..... resistance

**Note:**

- Consider displayed warnings before starting measurement!
- For compensation of test leads Description in chapter 6.2.1.1 *Compensation of test leads resistance* can be used as reference.

**6.3.2 Insulation resistance (supply circuit to protective circuit)**

The insulation resistance test checks the resistance between the primary supply circuit and the protective circuit (protective earth) of the welding machine.

The instrument measures the insulation resistance between:

- mains test socket's live terminals and mains test socket's PE terminal on 3-phase adapter (A1422).

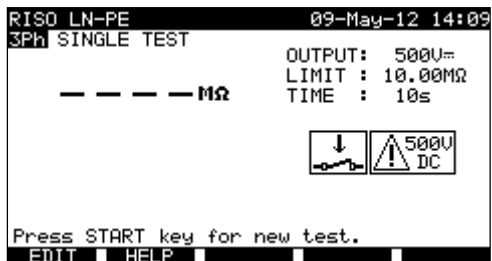

*Insulation LN-PE menu*

**Test parameters for insulation resistance LN-PE measurement**

OUTPUT	<b>Test voltage</b> [500 V]
LIMIT	<b>Minimum resistance</b> [2.50 MΩ, 5.00 MΩ, 10.00 MΩ, none]
TIME	<b>Measuring time</b> [5 s, 10 s, 30 s, 60 s, 120 s, none]

**Test circuit and measurement procedure for insulation resistance LN-PE measurement**

For more information refer to chapter **Measurements according to IEC/ EN 60974-4**, paragraph **Insulation resistance (supply circuit to protective circuit)** in 3-phase adapter user manual.

**Result screens:**

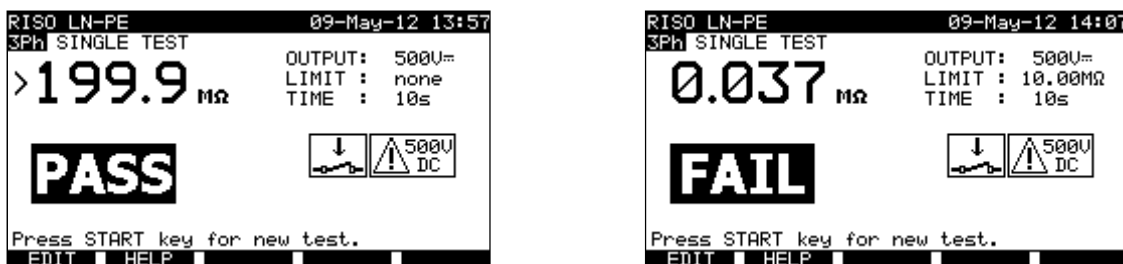

*Examples of Insulation LN-PE measurement results*

Displayed results:

Main result ..... Insulation resistance LN-PE

**Note:**

- Consider displayed warnings before starting measurement!

**6.3.3 Insulation resistance (welding circuit to protective circuit)**

The insulation resistance test checks the resistance between the welding circuit (outputs) and the protective circuit (protective earth) of the welding machine.

The instrument measures the insulation resistance between:

- mains test socket's PE terminal and W1/ W2\_TOUCH terminals on 3-phase adapter (A1422).

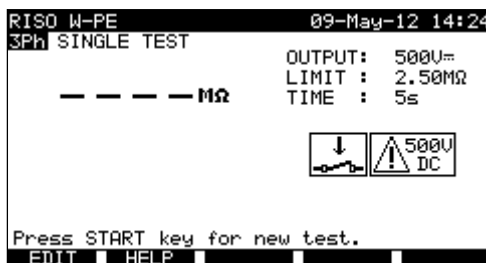

*Insulation W-PE menu*

**Test parameters for insulation resistance W-PE measurement**

OUTPUT	<b>Test voltage</b> [500 V]
LIMIT	<b>Minimum resistance</b> [2.50 MΩ, 5.00 MΩ, 10.00 MΩ, none]
TIME	<b>Measuring time</b> [5 s, 10 s, 30 s, 60 s, 120 s, none]

**Test circuit and measurement procedure for insulation resistance W-PE measurement**

For more information refer to chapter **Measurements according to IEC/ EN 60974-4**, paragraph **Insulation resistance (welding circuit to protective circuit)** in 3-phase adapter user manual.

**Result screens:**

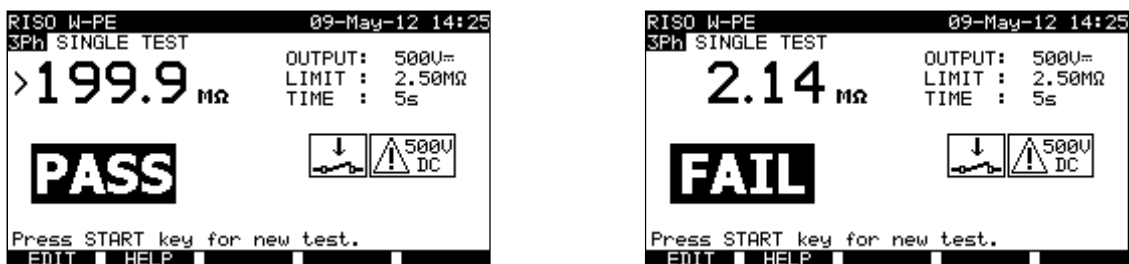

*Examples of Insulation W-PE measurement results*

Displayed results:

Main result ..... Insulation resistance W-PE

**Note:**

- Consider displayed warnings before starting measurement!

**6.3.4 Insulation resistance (supply circuit to welding circuit)**

The insulation resistance test checks the resistance between primary supply circuit and the welding circuit (outputs) of the welding machine.

The instrument measures the insulation resistance between:

- mains test socket's live terminals and W1/ W2\_TOUCH terminals on 3-phase adapter (A1422).

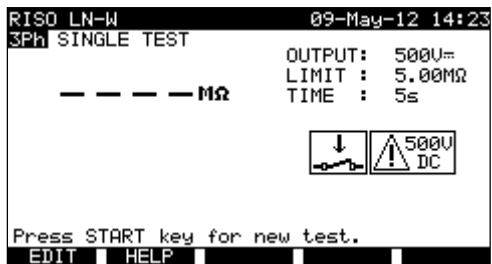

*Insulation LN-W menu*

**Test parameters for insulation resistance LN-W measurement**

OUTPUT	<b>Test voltage</b> [500 V]
LIMIT	<b>Minimum resistance</b> [5.00 MΩ, 10.0 MΩ, none]
TIME	<b>Measuring time</b> [5 s, 10 s, 30 s, 60 s, 120 s, none]

**Test circuit and measurement procedure for insulation resistance LN-W measurement**

For more information refer to chapter **Measurements according to IEC/ EN 60974-4**, paragraph **Insulation resistance (supply circuit to welding circuit)** in 3-phase adapter user manual.



**Result screens:**

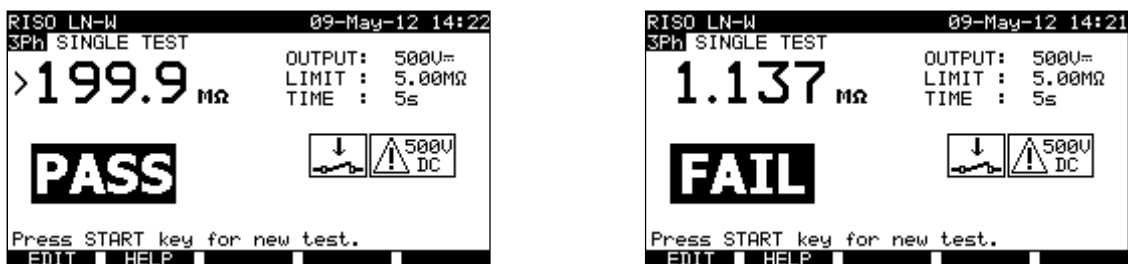

*Examples of Insulation LN-W measurement results*

Displayed results:

Main result ..... Insulation resistance LN-W

**Note:**

- Consider displayed warnings before starting measurement!

**6.3.5 Insulation resistance (supply circuit of class II equipment to accessible surfaces)**

The insulation resistance test checks the resistance between primary supply circuit and the isolated accessible conductive parts of the welding machine.

The instrument measures the insulation resistance between:

- mains test socket's live terminals on 3-phase instrument and the S/C1 terminal on MultiservicerXA.

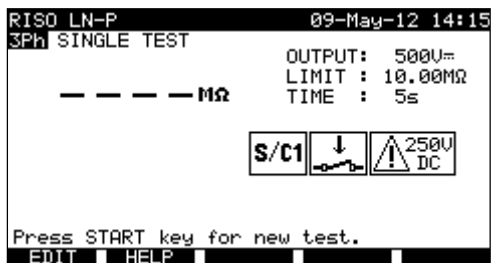

*Insulation LN-P menu*

**Test parameters for insulation resistance LN-P measurement**

OUTPUT	Test voltage [500 V]
LIMIT	Minimum resistance [5.00 MΩ, 10.0 MΩ, none]
TIME	Measuring time [5 s, 10 s, 30 s, 60 s, 120 s, none]

**Test circuit and measurement procedure for insulation resistance LN-P measurement**

For more information refer to chapter **Measurements according to IEC/ EN 60974-4**, paragraph **Insulation resistance (supply circuit of class II to accessible surfaces)** in 3-phase adapter user manual.

**Result screens:**

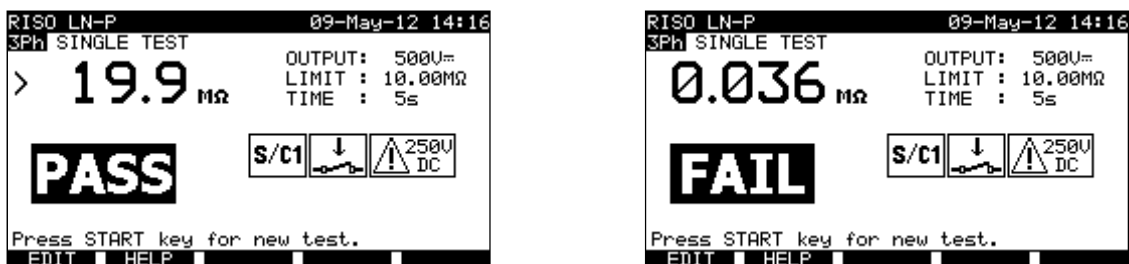

*Examples of Insulation LN-P measurement results*

Displayed results:

Main result ..... Insulation resistance LN-P

**Note:**

- Consider displayed warnings before starting measurement!

**6.3.6 Welding circuit leakage current**

The purpose of this test is to determine the sum of all leakage currents flowing from the welding outputs W1 or W2 to earth.

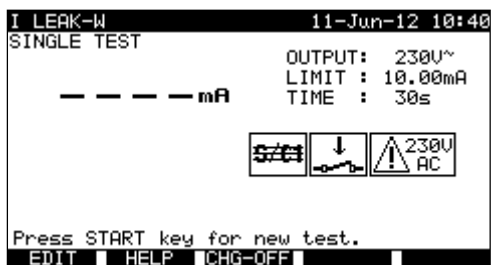

*Welding circuit leakage current menu*

**Test parameters for welding circuit current measurement**

LIMIT	<b>Maximum current</b> [3.50 mA, 5.00 mA, 10.00 mA, none]
TIME	<b>Measuring time</b> [5 s, 10 s, 30 s, 60 s, 120 s, none]

**Key (F3)**

CHG-OFF	Change between L-N on a single phase test socket of 3-phase adapter is disabled.
CHG-ON	Change between L-N on a single phase test socket of 3-phase adapter is enabled.

**Test circuit and measurement procedure for welding circuit leakage current measurement**

For more information refer to chapter **Measurements according to IEC/ EN 60974-4**, paragraph **Welding circuit leakage current** in 3-phase adapter user manual.

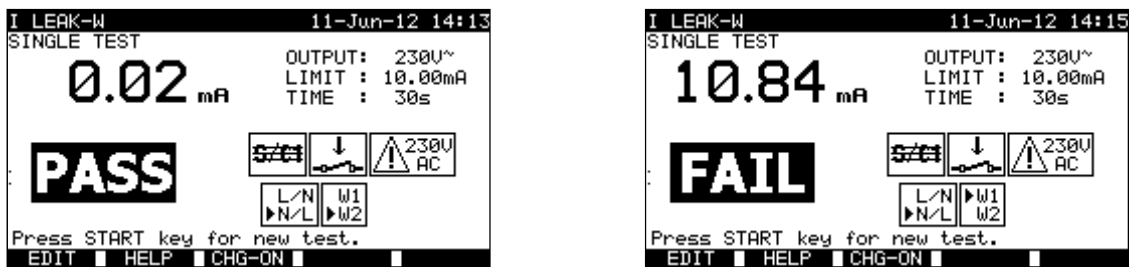

Examples of welding circuit leakage current measurement results

Displayed results:

Main result ..... welding circuit leakage current

**Notes:**

- During the test, a mains voltage is connected to the welding machine. Consider safety precautions.
- Consider any displayed warning before starting measurement!

**6.3.7 Primary leakage current**

The purpose of this test is to determine the sum of all leakage currents flowing from the primary circuit to earth. Because the differential measuring method for determining leakage current is used the full and true DUT leakage current is always measured, even when parallel current paths to ground exist in the DUT.

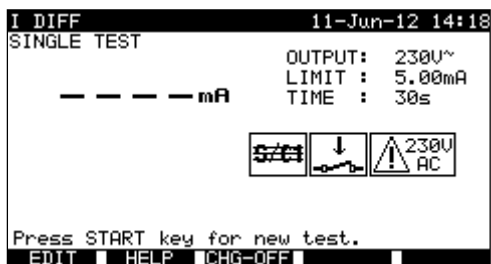

Primary leakage current menu

**Test parameters for primary leakage current measurement**

LIMIT	<b>Maximum current</b> [3.50 mA, 5.00 mA, 10.00 mA, none]
TIME	<b>Measuring time</b> [5 s, 10 s, 30 s, 60 s, 120 s, none]

**Key (F3)**

CHG-OFF	Change between L-N on a single phase test socket of 3-phase adapter is disabled.
CHG-ON	Change between L-N on a single phase test socket of 3-phase adapter is enabled.

**Test circuit and measurement procedure for primary leakage current measurement**

For more information refer to chapter **Measurements according to IEC/ EN 60974-4**, paragraph **Primary leakage current** in 3-phase adapter user manual.

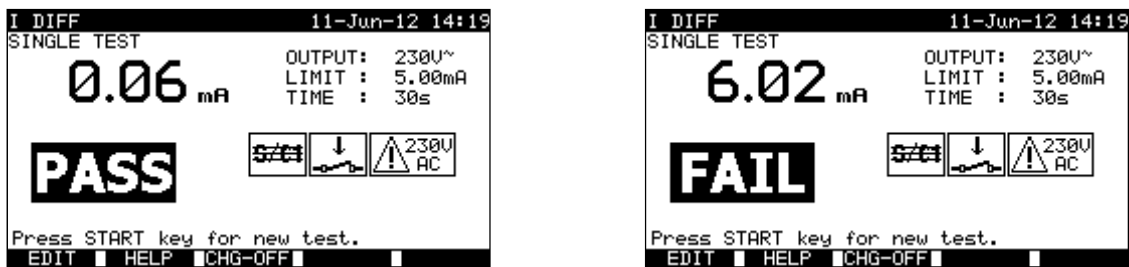

Examples of primary leakage current measurement results

Displayed results:

Main result ..... primary leakage current

**Notes:**

- During the test, a mains voltage is connected to the welding machine. Consider safety precautions.
- Consider any displayed warning before starting measurement!

**6.3.8 Touch leakage current**

Description in chapter 6.2.7 *Touch Leakage* can be used as reference.

**6.3.9 No load voltage**

The purpose of this test is to check that the voltage on the welding outputs doesn't exceed the safety limits.

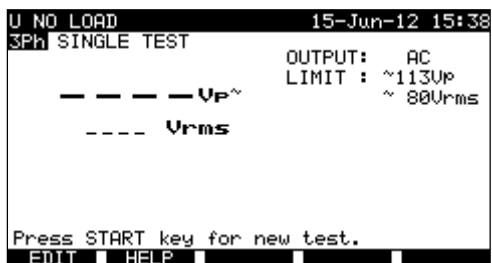

No load voltage menu

**Test parameters for No load voltage measurement**

VOLTAGE	[AC, DC]
LIMIT AC	<p><b>Maximum voltage:</b></p> <ul style="list-style-type: none"> <li>› 68 V peak and 48 V r.m.s.</li> <li>› 113 V peak and 80 V r.m.s.,</li> <li>› 141 V peak and 100 V r.m.s.,</li> <li>› none.</li> </ul>
LIMIT DC	<p><b>Maximum voltage:</b></p> <ul style="list-style-type: none"> <li>› 113 Vpeak,</li> <li>› 141 Vpeak,</li> <li>› None.</li> </ul>

### Test circuit and measurement procedure for No load voltage measurement

- For more information refer to chapter **Measurements according to IEC/ EN 60974-4**, paragraph **No load voltage** in 3-phase adapter user manual.

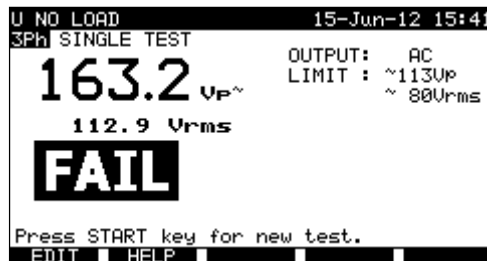
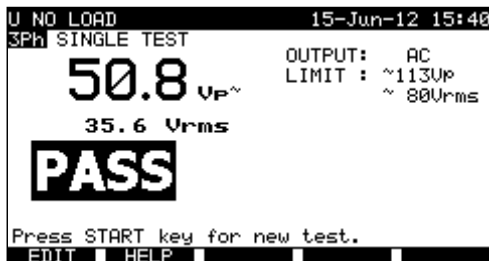

Examples of No load voltage measurement results

Displayed results:

Main result ..... no load a.c. or d.c. peak voltage

Sub-result..... no load r.m.s. voltage

#### Notes:

- During the test, a mains voltage is connected to the welding machine. Consider safety precautions.
- Consider any displayed warning before starting measurement!

### 6.3.10 Clamp current test

Description in chapter 6.2.9 *Clamp current test* can be used as reference.

### 6.3.11 Functional test

Descriptions in chapter 6.2.11 *Power/ Functional tests* can be used as reference.

## 7 Autotest sequences

Autotest is the fastest and easiest way to test DUTs. During the autotest preprogrammed measurements runs automatically in a sequential way. The complete autotest results can be stored together with their associated DUT name and all related information.

### 7.1 VDE organizer – general menu

VDE organizer is a configuration tool for performing VDE 0701-0702 compatible device test sequences.

The instrument selects the appropriate test sequence and parameters on base of entered DUT data (class, accessible conductive parts, nominal power etc).

The test sequence is built up according to the flowchart below.

In addition tests for RCDs can be added to the sequence.

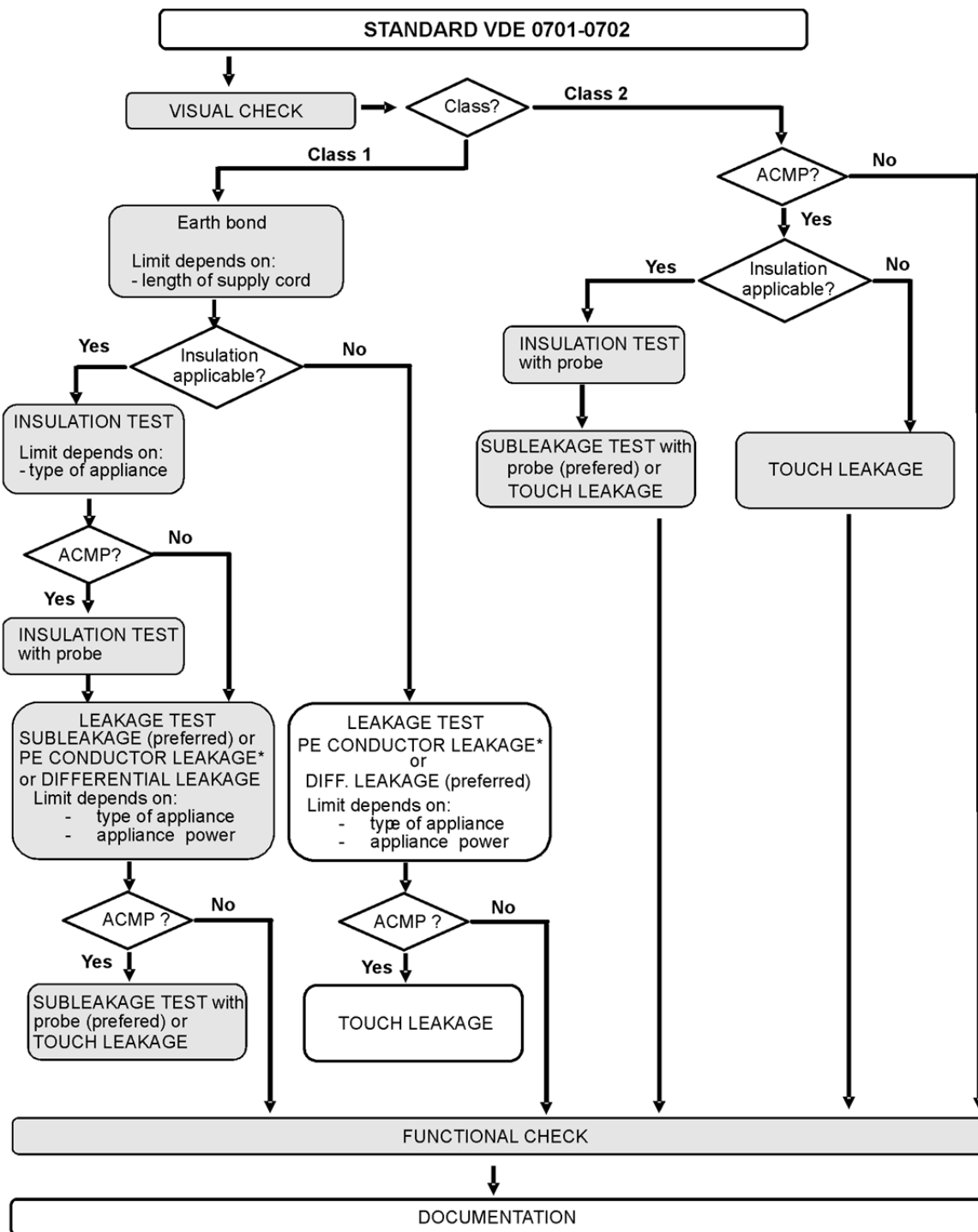

ACMP = accessible conductive part separated from earth

With the VDE organizer any VDE 0701-0702 compatible test sequence can be created. The sequences cover virtually any maintenance or periodic test, regardless of DUT type, safety class, supply cord length, fuse type, etc. All limits and tests comply with the currently valid VDE standards and regulations. In case of any changes, a firmware upgrade will be available.

### 7.1.1 VDE organizer operation

Select VDE Organizer in PAT testing main menu.

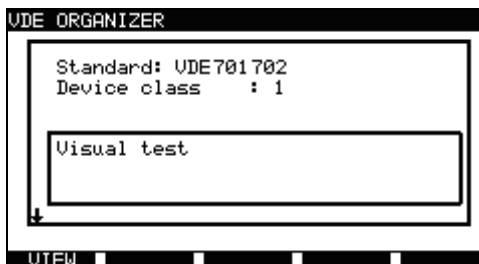

Example of VDE organizer screen

Keys:

- ▲ / ▼ Select organizer item.
- ◀ / ▶ Set parameter in selected (highlighted) item.
- ESC Returns to previous menu.
- VIEW (F1) Enters View (test sequence) menu.
- START Starts automatic sequence as currently set in VDE organizer.  
Refer to chapter 7.5 Performing autotest sequences for more information.

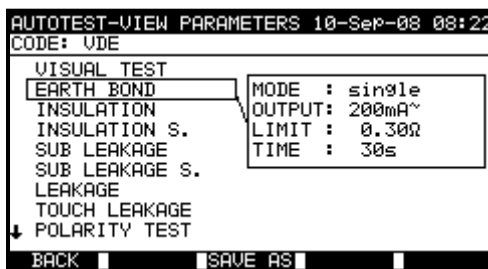

VDE organizer view menu

In the View menu the parameters of the selected measurement can be viewed.

Keys in View menu:

▲ / ▼	Select test to be viewed.
START	Starts automatic sequence as currently set in VDE organizer. Refer to chapter 7.5 Performing autotest sequences for more information.
SAVE AS (F3)	Opens dialog for saving currently set sequence as a custom autotest.
BACK (F1)	Returns to mains VDE organizer menu.
ESC	Returns to previous menu.

**Note:**

- HW 4.x or higher :  
When PRCD test is enabled in autotest sequence then mains supply voltage is applied on test socket during earth bond test (if selected in autotest sequence).



## 7.1.2 Example of creating a test sequence with VDE organizer

A periodic test of an iron will be performed.

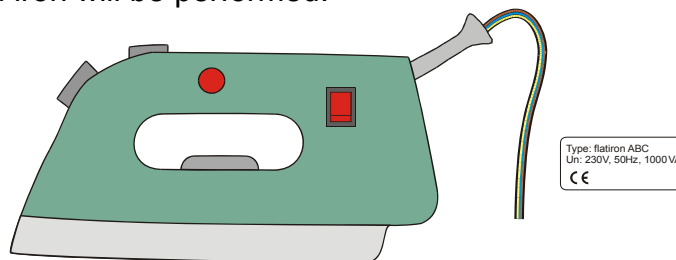

The iron can be classified as followed:

- For a periodic testing a VDE 0701-0702 test is relevant.
- The iron can be classified as a Class I DUT with isolated metal part and short supply cord.

Example of test sequence configuration:

	Displayed item	Activity
1	Standard: VDE	Information that a test acc. to VDE 0701-0702 will be set.
2	DUT class: <b>1</b>	Selection of DUT safety class: - Select Class 1.
3	Visual test	Information that visual test will be included in the VDE / Class1 procedure.
4	Accessible conductive parts? <b>YES</b>	Question if there is an isolated conductive part on the DUT: - Confirm with yes.
5	Cord length (Earth bond) L: <b>&lt; 0.3 Ω / &lt;= 5 m</b>	Selection of Earth bond limit value on base of known supply cable length: - Select appropriate length.
6	Insulation test applicable? <b>YES</b>	Question if insulation test is applicable: - Confirm with yes.  Insulation and substitute leakage measurements will be included in the test sequence with this confirmation.
7	Insulation test <b>Heating elements L: &gt;0.3 MΩ</b>	Classification of DUT: - Classify the iron as a standard DUT.
8	Insulation test Accessible cond. Parts L: >2.0 MΩ	Information that insulation resistance measurement of Class 2 parts will be included in the (VDE / Class1 / with isolated conductive parts) test procedure.
9	Leakage test method: <b>Leakage</b>	Selection of leakage current test method: - Select substitute leakage measurement.
10	Limit / Device type <b>General device L &lt; 3.5 mA</b>	Classify the iron as an standard DUT with power <3.5 kW.
11	Touch leakage method: Substitute leakage Limit < 0.5 mA	Information that substitute leakage current measurement class 2 parts will be included in the (VDE / Class1 / with isolated conductive parts) test procedure.

## 7.2 Custom autotests

In autotest custom menu setting and editing user-defined autotest procedures is allowed. Two sets (one for portable appliances and one for welding machines) of up to 50 custom autotest sequences can be pre-programmed in this autotest mode.

The most often used autotest sequences are added to the list by default.

The sequences can be also uploaded from the PC software PATLink PRO. Refer to chapter 8.5 *Data upload / download* for more information.

The pre-programmed sequences can be restored to default settings by selecting *Original settings* in *General settings menu*.

Select Custom Autotest in PAT testing main menu.



Custom autotest menu  
– appliances



Custom autotest menu  
– welding machines

Keys:

▼ / ▲	Selects the custom autotest.
<b>VIEW</b> (F1)	Opens View menu for viewing details of selected test sequence
<b>DELETE</b> (F3)	Removes selected test, see chapter 7.2.1 <i>Deleting an existing custom test sequence</i> .
<b>APPL. / WELDING</b> (F4)	Switches between the two sets of custom autotests (if applicable).
<b>START</b>	Starts the selected autotest. See chapter 7.5 <i>Performing autotest sequences</i> .
<b>ESC</b>	Returns to Main menu.

**Notes:**

- For testing welding machines the 3 phase operation mode must be enabled and the MultiservicerXA must be connected to a METREL 3-phase adapter (A1422). See 3-phase adapter (A1322 / A1422) user manual for more information.
- If more than 50 autotests are saved, »*Out of memory*« message is displayed.
- HW 4.x or higher :  
When PRCD test is enabled in autotest sequence then mains supply voltage is applied on test socket during earth bond test (if selected in autotest sequence).

### 7.2.1 Deleting an existing custom test sequence



Delete selected custom autotest sequence

Keys:

<b>Y/ N</b>	Confirms or rejects deleting of selected custom autotest sequence.
Any other key	Return back to custom autotest menu without changes.

**Note:**

- First custom autotest from the list cannot be deleted!

### 7.2.2 Viewing, modifying and saving an custom autotest

An existing custom autotest sequence can be viewed, modified and stored. These functionalities are available in the *Custom autotest view menu*.

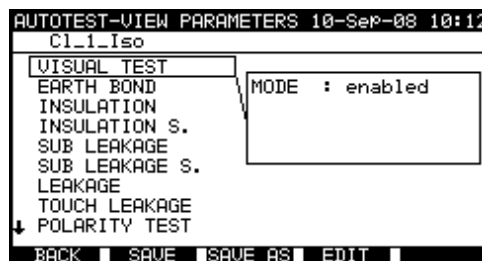

View setup of selected custom autotest

Keys in custom autotest sequence view mode:

<b>BACK (F1)</b>	Returns back to custom autotest main menu.
<b>SAVE (F2)</b>	Stores test sequence under the same name.
<b>SAVE AS (F3)</b>	Stores test sequence under a new name.
<b>EDIT (F4)</b>	Opens menu for modifying parameters of selected test function.
<b>▲ / ▼</b>	Select test function in the sequence.
<b>START</b>	Starts running the selected autotest. See chapters 7.5 <i>Performing autotest sequences – appliances</i> or 6.6 <i>Performing autotest sequences – welding machines</i> .
<b>ESC</b>	Returns back to custom autotest menu.



Save option



Save as option

Autotest custom Save menus

Keys:

< / >	Select character in line.
Alphanumeric	Enters character.
SHIFT+ Alphanumeric	Enters small letter or special character.
←	Deletes character left to cursor.
SAVE (F1)	Confirms saving custom autotest sequence under entered name.
UNDO (F2)	Cancels saving.
ESC	Returns back to custom autotest menu.

Modification of an autotest sequence

Press EDIT (F4) key in the View menu to modify selected function.

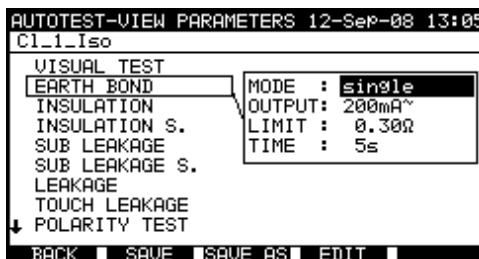

Modification parameters of selected test function

Keys:

▼ / ▲	Select the parameter.
< / >	Change the value of selected parameter (highlighted).
CONFIRM (F1)	Accepts modified function and returns to the view of selected test sequence.
ESC	Returns to the view of selected test sequence.

Following modes can be set:

disabled	Test is not selected in this custom autotest.
single	Selected test is performed once inside the custom autotest.
continuous	Selected test is performed more than once inside the custom autotest.

## 7.3 Project autotests

The **Project autotests** is a unique tool that dramatically simplifies and speeds up repeated (periodic) testing of DUTs.

The main idea is to re-use known stored data (either in instrument or on a PC) of the tested DUT. The following data can be recalled from the instrument's memory and re-used:

### Test sequence

If the sequence has not changed (this is usually the situation) the user does not need to care about setting the right test sequence and parameters.

### DUT data

ID number, names, descriptions, addresses, comments are not needed to be re-entered again. Old data are offered by default.

### Old test results

New Project Autotest test results can be compared with previous results. The instrument automatically calculates the trends for each measurement.

### Note:

- If the test results are close to the limit they should be compared with old test results. If the trends are deteriorating, the safety of the DUT and the time between tests should be reassessed. If the results stay stable the DUT can generally be treated as safe.

Old test results can be uploaded from a PC back to the instrument. This brings further advantages:

- Old test results are not occupying the instrument's memory and can be temporarily uploaded only for the purpose of re-testing,
- Test results and DUT data can be moved / shared among different test instruments,
- DUT data can be pre-entered on the computer and then sent to the instrument.

### 7.3.1 Selecting a project autotest

The first step when performing project autotests is to recall the appropriate stored DUT data from the instrument's memory. The procedure is similar as if test results are to be recalled from the instrument's memory.

In the **PAT testing main menu** select **Project autotests** by using  $\wedge$  and  $\vee$  keys and press ENTER key to confirm. **Search project autotest menu** will be displayed.



*Project autotests main menu*

When searching for stored autotest results the following filters can be used to narrow the hits:

- Device number,
- User,
- Test site,
- Location,
- Date from and date to.

Keys:

▼ / ▲	Select filter line.
◀ / ▶, Alphanumeric	Edits selected filter.
<b>FIND</b> (F1)	Starts search after filters are set correctly.
<b>UNDO</b> (F2)	Undo latest change.
<b>TYPE</b> (F3)	Selects parameter line type.
<b>ESC</b>	Returns to Main menu.

**Notes:**

- To change the selected parameter line type, press the TYPE (F3) key and the »parameter type« will become highlighted (e.g. DUT). The keys ◀ and ▶ can then be used to change the parameter type and by pressing ENTER key the choice can be confirmed. Once the parameter types have been set up, the data required to filter the files can be inserted. Filter information can be inserted via the alphanumeric keypad or, in some filter fields such as user, can also be selected from a predefined list by pressing the LIST (F4) key. The DUT number field can also be read using a barcode reader.
- By placing a »\*« (shift + "2") in a particular field, tells the instrument not to search the associated filter field. When searching, the instrument will therefore ignore data in this parameter and go on to find all the DUTs that conform to data placed in the other filter fields.
- To find all stored results, enter »\*« in the all fields (excluding DATE where the correct from and to dates must be entered).

If the search filters are set up correctly and the DUTs exist in the units memory, the **Project autotests result menu** will be displayed.

While recalling stored results, the instrument shows a bar graph and a ratio of files found compared to files stored in memory (e.g. 7/11 implies 7 results have been found to meet the filter criteria out of a potential 11 results stored in the flash memory).



*Project autotest result menu*

Keys:

▼ / ▲	
PgUp (F1)	Select the DUT that should be retested.
PgDown (F2)	
ENTER	Recalls autotest project results for selected DUT.
START	Starts running new autotest for selected DUT, see 7.3.2 <i>Starting a project autotest</i>
ESC	Returns to Main menu.

**Note:**

- Barcode reader can also be applied for selecting the DUT, see chapter 6.4 *Working with barcode / RFID tag.*

**DUT tickers**

Each DUT is marked with a ticker. The ticker appears at the right of the DUT number and helps to speed up finding DUTs to be retested. The meaning of the tickers is as follows:

- PC The stored DUT data was uploaded from PC
- PC✓ The stored DUT data was uploaded from PC and has been retested
- I The stored DUT data was performed with the instrument and stored.
- I✓ The stored DUT data was performed with the instrument and stored and has been retested.

**Recalling autotest project results for selected DUT**

By pressing ENTER key on an DUT, more information regarding the DUT results and data can be viewed.

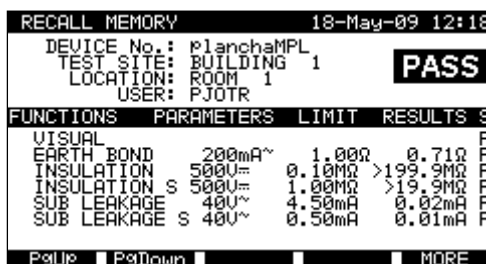

*View results menu examples*

Keys:

▼ / ▲	Scrolls over stored results of particular functions for selected custom autotest sequence.
PgUp (F1)	
PgDown (F2)	
MORE (F5)	Switches between multiple DUT data views.
ESC	Returns to previous menu.

### 7.3.2 Starting a project autotest

Select Project Autotest in PAT testing main menu.

Using the filters, search for the DUTs to be retested. After the DUT is found and selected (in Project autotest result menu) begin retesting the DUT by pressing the START key.

The autotest sequence will be the same as it was for the selected Project autotest.

Exactly the same DUT data (except time and user) will be offered to store in the selected Project autotest.

When a new autotest is saved, it will get an »I« ticker. The original autotest will get a »I✓« or »PC✓« ticker when the DUT is retested through the project autotest.

### 7.3.3 Comparison of results (evaluation of result trends)

If an autotest sequence was performed from the Project autotests menu, an additional option TREND is offered in the **View result** menu after the autotest is finished.

VIEW RESULTS		18-May-09 12:27	
DEVICE No.: PlanchaMPL			
TEST SITE: BUILDING 1			
LOCATION: ROOM 1			
USER: PJOTR			
<b>PASS</b>			
FUNCTIONS	PARAMETERS	LIMIT	RESULTS
VISUAL			P
EARTH BOND	200mA~	1.00Ω	0.10Ω P
INSULATION	500U=	0.10MΩ	>199.9MΩ P
INSULATION S	500U=	1.00MΩ	>19.9MΩ P
SUB LEAKAGE	40U~	4.50mA	0.04mA P
SUB LEAKAGE S	40U~	0.50mA	0.01mA P
PgUp PgDown TREND MORE			

*View Project autotest results menu*

In the Save results window, press the VIEW (F4) key the results to enter the view results window. By pressing TREND (F4) key again a comparison between the old and new test data will be performed. This is a very useful feature to evaluate result trends in cases where results are relatively close to the limit.

#### Evaluation of test results

COMPARE RESULTS		18-May-09 12:28	
DEVICE : PlanchaMPL			
OLD: 24/04/2009 - PASS			
NEW: 18/05/2009 - PASS			
<b>PASS</b>			
FUNCTIONS	OLD	NEW	TREND
EARTH BOND	0.71Ω	0.10Ω	↑
INSULATION	>200MΩ	>200MΩ	○
INSULATION S	20.0MΩ	20.0MΩ	○
SUB LEAKAGE	0.02mA	0.04mA	↓
SUB LEAKAGE S	0.01mA	0.01mA	↓
RESULT			

*Compare results menu example*

Meaning of trend symbols:

↑ New result of particular test is better than last result.



Examples: New insulation resistance result is higher than old result.  
 New earth bond result is lower than old one.

- Difference between old and new result of particular test is so small that can be treated as the same.  
 Example: New insulation resistance result stays at the same level as old result.
- ↓ New result of particular test is worse than last result.  
 Examples: New insulation resistance result is lower than old result.  
 New earth bond result is higher than old one.

Keys:

▼ / ▲	Scroll over comparison results of particular functions.
<b>PgUp</b> (F1)	
<b>PgDown</b> (F2)	
<b>RESULT</b> (F5)	Returns to View results menu.
<b>ESC</b>	Returns to Project autotest menu.

### 7.4 Barcode / TAG autotests

Barcode/ TAG menu supports operation with barcodes and RFID tags. From this menu the following actions can be performed:  
 Device test sequences can be read from barcode labels.  
 Test sequences and stored measurement results for tested DUT can be downloaded (uploaded) from (to) the RFID tags.

Select Barcode/ TAG in PAT testing main menu.

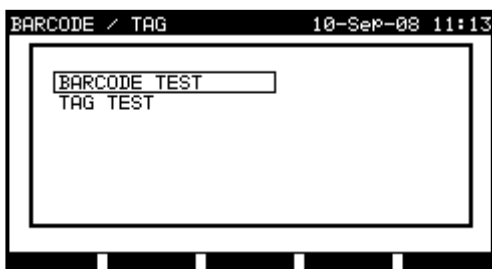

Barcode / TAG menu - appliances



Barcode menu – welding machines

Keys:

▼ / ▲	Select the device.
<b>ENTER</b>	Opens menu for selected device.
<b>APPL.(F4)</b> / <b>WELDING (F4)</b>	Switches between operating mode for appliances and welding machines
<b>ESC</b>	Returns to Main menu.

### 7.4.1 Working with RFID tags

To use RFID system, connect RFID reader/writer to DB-9 female BARCODE connector first. See *RFID reader/writer user manual* for more information.

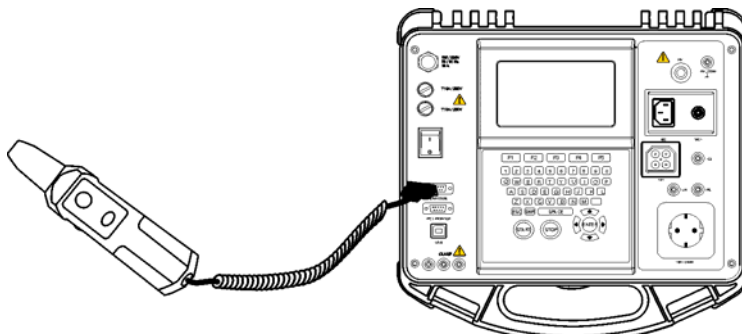

Connecting RFID tag reader/writer to the instrument MultiservicerXA

**Note:**

- Because of limited memory space of RFID tags, the following data are not stored in RFID tags:
  - DUT name,
  - Repairing code,
  - Comments.

#### Loading data from RFID tags to the instrument

Select **Tag test** from **Barcode / tag** menu and press the ENTER key to confirm. The MultiservicerXA instrument is now ready to accept RFID tag data.

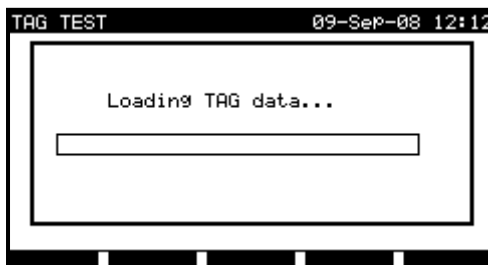

RFID tag menu

Once the data from RFID tag have been successfully received, the following menu is displayed:



RFID tag menu

Keys:

▼ / ▲	Select the option.
<b>ENTER</b>	Opens menu for selected option.
<b>ESC</b>	Returns to Barcode/tag menu.

If no test results were stored in RFID tag, the **View results** option won't be displayed.

The following actions can be performed now:

- New reading from RFID tag,
- View autotest sequence,
- View autotest results,
- Start autotest sequence.

### Viewing autotest sequence from RFID tag

Select **View autotest** in **TAG menu** and press **ENTER** key to confirm. Refer to chapter 7.2.2 *Viewing/modifying and saving of existing custom autotest*.

### Starting autotest sequence from RFID tag

Select **Start new autotest** in **TAG menu** and press **ENTER** key. Refer to chapter 7.5 *Performing autotest sequences - appliances*.

### Viewing autotest results from RFID tag

Select **View results** in **TAG menu** and press **ENTER** key to confirm. Refer to chapter 8.2 *Recalling results*.

### Sending an autotest sequence to RFID tag

From the **Autotest custom menu** press the **SEND (F5)** key. Selected autotest sequence is loaded to the RFID tag using RFID reader/writer. See RFID reader/writer user manual for more information.

### Sending an autotest sequence/results to RFID tag

Autotest sequence/results can be sent to RFID TAG from the **Save results** or **Recall memory** menu. Press the **SEND (F3)** key. When sending data from **Recall results** menu select **TAG reader/writer** option first and press **ENTER** key to confirm. Selected data from the instrument are loaded to the RFID tag using RFID reader/writer. See RFID reader/writer user manual for more information.

### 7.4.2 Working with barcode reader

The instrument supports the following functions:

- Reading 24 pre-defined autotest shortcut codes from barcode labels,
- Reading DUT numbers from barcode labels.

Two Barcode systems are supported. Refer to Appendix B for detailed information. Connect barcode reader to the DB-9 female BARCODE connector first.

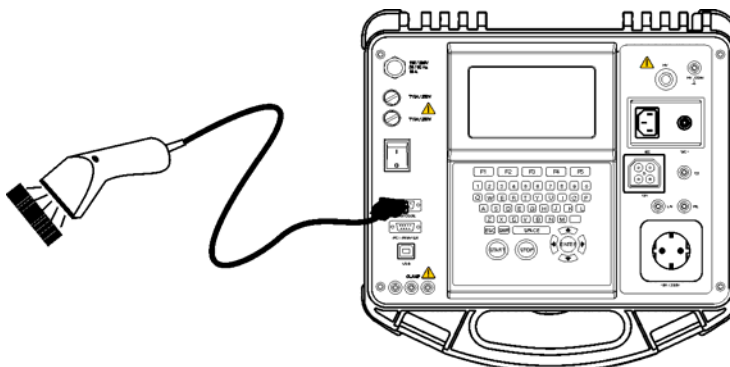

Connecting barcode reader to the MultiservicerXA instrument

#### Reading autotest sequence using barcode

Select **Barcode test** in **Barcode/tag menu** and press ENTER key. The latest received or set autotest sequence name and its code is displayed. A new autotest sequence received from the barcode reader will be accepted by the instrument (refer to Appendix A for available autotest sequences and its codes). A successful receive of the barcode is confirmed by two short confirmation beeps.

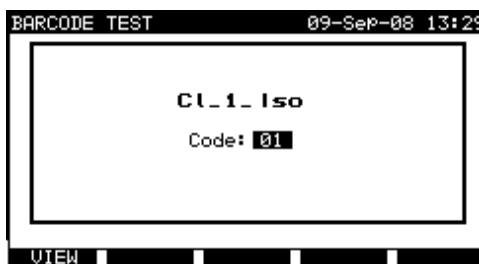

Barcode test menu

Keys:

<b>VIEW</b> (F1)	Views selected autotest sequence. Refer to chapter 7.2.2 <i>Viewing/modifying of existing custom autotest</i> .
<b>START</b>	Starts selected autotest sequence. Refer to chapter 7.5 <i>Performing autotest sequence</i> .
<b>&lt; / &gt;</b>	Manually selects a new autotest sequence by setting its code.
<b>ESC</b>	Returns to Barcode/tag menu.

## Reading DUT number using barcode

With the barcode reader also DUT number can be read from barcode label in different menus. A successful receive of the barcode is confirmed by two short confirmation beeps.

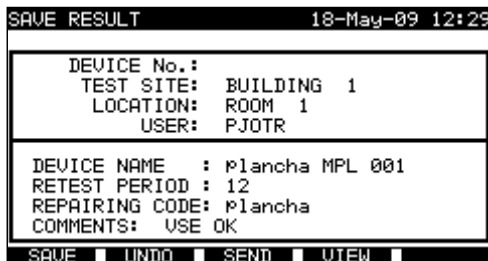

*Adding DUT number in save results / search results menu*

## 7.5 Performing autotest sequences – for appliances

### 7.5.1 Visual inspection

A thorough visual check must be carried out before each electrical safety test.

Following items should be checked:

- Inspection of DUT for sign of damage.
- Inspection of flexible supply cable for damage.
- Any signs of pollution, moisture, dirt that can jeopardize safety. Especially openings, air filters, protection covers and barriers must be checked!
- Are there signs of corrosion?
- Are there signs of overheating?
- Inscriptions and marking related to safety must be clearly readable.
- Installation of the DUT must be performed according to the user manuals.
- During visual inspection the measuring points for the electrical testing have to be determined too.

If the visual test passes, the instrument automatically proceeds with the next test in the sequence.

If the visual test fails the user must evaluate if it is safe to proceed with the measurements.

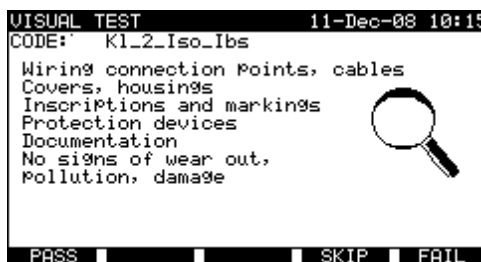

*Visual test menu*

## Keys

<b>PASS</b> (F1)	Confirms that the visual inspection passed.
<b>SKIP</b> (F4)	Skips visual test.
<b>FAIL</b> (F5)	Ends the autotest sequence.

### 7.5.2 Earth bond resistance measurement

Measurement is described in chapter 6.2.1 *Earth bond resistance*.

If the earth bond test fails or was skipped other tests (except Polarity) will not be carried out because of safety.

## Keys

<b>START</b>	Starts the earth bond resistance measurement. Proceeds with the next earth bond resistance measurement (in continuous mode). Proceeds to the next autotest sequence measurement (in single measurement mode only).
<b>HELP</b> (F2)	Displays the earth bond test help screens.
<b>REPEAT</b> (F3)	Repeats the earth bond resistance measurement.
<b>ENTER</b>	Proceeds to the next autotest sequence measurement (in continuous measurement mode only).
<b>SKIP</b> (F4)	Skips earth bond resistance measurement.
<b>END</b> (F5)	Ends the autotest sequence.

**Notes:**

- Compensation of test leads resistance should be performed before doing autotests.
- For compensation of test leads description in chapter 6.2.1.1 *Compensation of test leads resistance* can be used as reference.
- When polarity test is enabled in autotest sequence then earth bond resistance is performed between IEC test connector (PE terminal) and test socket (PE terminal). If polarity test is disabled in autotest sequence, earth bond test is performed between EB/S test probe and test socket (PE terminal).
- HW 4.x or higher :  
When PRCD test is enabled in autotest sequence then mains supply voltage is applied on test socket during earth bond test (if selected in autotest sequence).

### 7.5.3 Insulation resistance measurement

Measurement is described in chapter 6.2.2 *Insulation resistance*.

If the insulation test fails or was skipped other tests (except Polarity) will not be carried out because of safety.

## Keys

<b>START</b>	Starts the insulation resistance measurement. Proceeds with the next insulation resistance measurement (in continuous mode). Proceeds to the next autotest sequence measurement (in single measurement mode only).
<b>HELP</b> (F2)	Displays the insulation test help screens.

<b>REPEAT</b> (F3)	Repeats the earth bond resistance measurement.
<b>ENTER</b>	Proceeds to the next autotest sequence measurement (in continuous measurement mode only).
<b>SKIP</b> (F4)	Skips insulation resistance measurement.
<b>END</b> (F5)	Ends the autotest sequence.

#### 7.5.4 Insulation resistance S measurement

Measurement is described in chapter 6.2.3 *Insulation resistance S*.

If this insulation test fails or was skipped other tests (except Polarity) will not be carried out because of safety.

Keys

<b>START</b>	Starts the Insulation resistance S measurement.
	Proceeds with the next insulation resistance S measurement (in continuous mode).
	Proceeds to the next autotest sequence measurement (in single measurement mode only).
<b>HELP</b> (F2)	Displays the insulation resistance S measurement help screens.
<b>REPEAT</b> (F3)	Repeats the insulation resistance S measurement.
<b>ENTER</b>	Proceeds to the next autotest sequence measurement (in continuous measurement mode only).
<b>SKIP</b> (F4)	Skips insulation resistance S measurement.
<b>END</b> (F5)	Ends the autotest sequence.

#### 7.5.5 Substitute leakage current measurement

Measurement is described in chapter 6.2.4 *Substitute leakage current*.

If the substitute leakage test fails or was skipped other tests (except Polarity) will not be carried out because of safety.

Keys

<b>START</b>	Starts the substitute leakage current measurement.
	Proceeds with the next substitute leakage current measurement (in continuous measurement mode only).
	Proceeds to the next autotest sequence measurement (in single measurement mode only).
<b>HELP</b> (F2)	Displays substitute leakage test help screens.
<b>REPEAT</b> (F3)	Repeats the substitute leakage current measurement.
<b>ENTER</b>	Proceeds to the next autotest sequence measurement (in continuous measurement mode only).
<b>SKIP</b> (F4)	Skips substitute leakage current measurement.
<b>END</b> (F5)	Ends the autotest sequence.

#### 7.5.6 Substitute leakage S measurement

Measurement is described in chapter 6.2.5 *Substitute leakage S*.

If the substitute leakage S test fails or was skipped other tests (except Polarity) will not be carried out because of safety.

Keys

<b>START</b>	Starts the Substitute leakage S current measurement. Proceeds with the next substitute leakage S current measurement (in continuous measurement mode only). Proceed to the next autotest sequence measurement (in single measurement mode only).
<b>HELP (F2)</b>	Displays substitute leakage S test help screens.
<b>REPEAT (F3)</b>	Repeats the substitute leakage S current measurement.
<b>ENTER</b>	Proceeds to the next autotest sequence measurement (in continuous measurement mode only).
<b>SKIP (F4)</b>	Skips substitute leakage S current measurement.
<b>END (F5)</b>	Ends the autotest sequence.

### 7.5.7 Differential leakage current

Measurement is described in chapter 6.2.6 *Differential leakage current*.

If the differential leakage test fails or was skipped other tests will not be carried out because of safety.

Keys

<b>START</b>	Starts the leakage current measurement. Proceeds with the next leakage current measurement (in continuous measurement mode only). Proceed to the next autotest sequence measurement (in single measurement mode only).
<b>HELP (F2)</b>	Displays leakage test help screens.
<b>REPEAT (F3)</b>	Repeats the leakage current measurement.
<b>ENTER</b>	Proceeds to the next autotest sequence measurement (in continuous measurement mode only).
<b>SKIP (F4)</b>	Skips leakage current measurement.
<b>END (F5)</b>	Ends the autotest sequence.

### 7.5.8 Touch leakage current measurement

Measurement is described in chapter 6.2.7 *Touch leakage current*.

If the touch leakage test fails or was skipped other tests will not be carried out because of safety.

Keys

<b>START</b>	Starts the touch leakage current measurement. Proceeds with the next touch leakage current measurement (in continuous measurement mode only). Proceed to the next autotest sequence measurement (in single measurement mode only).
<b>HELP (F2)</b>	Displays touch leakage test help screens.
<b>REPEAT (F3)</b>	Repeats the touch leakage current measurement.
<b>ENTER</b>	Proceeds to the next autotest sequence measurement (in continuous measurement mode only).



measurement mode only).  
**SKIP (F4)** Skips touch leakage current measurement.  
**END (F5)** Ends the autotest sequence.

### 7.5.9 Polarity test

Measurement is described in chapter 6.2.8 *Polarity test*.

If the polarity test fails or was skipped other tests will not be carried out because of safety.

Keys

<b>START</b>	Starts the polarity test. Proceed to the next autotest sequence measurement.
<b>HELP (F2)</b>	Displays polarity test help screens.
<b>REPEAT (F3)</b>	Repeats the polarity test.
<b>SKIP (F4)</b>	Skips polarity test.
<b>END (F5)</b>	Ends the autotest sequence.

### 7.5.10 TRMS current measurement using clamp current adapter

Measurement is described in chapter 6.2.9 *Clamp current measurement*.

If the current clamp test fails or was skipped other tests will not be carried out because of safety.

Keys

**START** Starts the TRMS leakage current measurement.  
 Proceeds with the next TRMS leakage current measurement (in continuous measurement mode only).  
 Proceeds to the next autotest sequence measurement (in single measurement mode only).  
**HELP (F2)** Displays TRMS leakage current help screens.  
**REPEAT (F3)** Repeats the TRMS leakage current measurement.  
**ENTER** Proceeds to the next autotest sequence measurement (in continuous measurement mode only).  
**SKIP (F4)** Skips TRMS leakage current measurement.  
**END (F5)** Ends the autotest sequence.

### 7.5.11 PRCD test

Measurement is described in chapter 6.2.10 *PRCD test*.

If the PRCD test fails or was skipped other tests will not be carried out because of safety.

Keys:

**START** Starts the PRCD test.  
 Proceeds to the next autotest sequence measurement.

<b>HELP</b> (F2)	Displays PRCD test help screens.
<b>REPEAT</b> (F3)	Repeats the PRCD test.
<b>SKIP</b> (F4)	Skips the PRCD test.
<b>END</b> (F5)	Ends the autotest sequence.

□ HW 4.x or higher :

When PRCD test is enabled in autotest sequence then mains supply voltage is applied on test socket during earth bond test (if selected in autotest sequence).

## 7.5.12 Functional test

The main objective of this test is to verify correct operation of the DUT.

Especially items relevant for safety should be checked:

- All main operating modes. Testing power during this check is useful.
- Mechanical operation (motors, rotating parts)
- Safety relevant functions (alarms, switches etc)

A PASS/ FAIL ticker can be committed manually.

The power measurement can be carried out optionally and is stored too. The Power measurement is described in chapter 6.2.11 *Power / Functional test*.

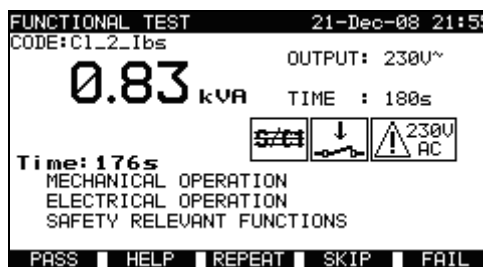

*Functional test menu*

Keys:

<b>START</b>	Starts the POWER test (optional). Proceeds to the next autotest sequence measurement.
<b>PASS</b> (F1)	Commits a manual ticker and ends autotest.
<b>HELP</b> (F2)	Displays Functional test help screens.
<b>SKIP</b> (F4)	Skips the Functional test.
<b>FAIL</b> (F5)	Commits a manual ticker and ends the autotest sequence.

## 7.6 Performing autotest sequences – for welding machines

### 7.6.1 Visual inspection

A thorough visual check must be carried out before each electrical safety test.

Following items should be checked:

- Inspection of DUT for sign of damage.
- Inspection of flexible supply cable for damage.
- Any signs of pollution, moisture, dirt that can jeopardize safety. Especially openings, air filters, protection covers and barriers must be checked!
- Are there signs of corrosion?

- Are there signs of overheating?
- Inscriptions and marking related to safety must be clearly readable.
- Installation of the DUT must be performed according to the user manuals.
- During visual inspection the measuring points for the electrical testing have to be determined too.

If the visual test passes, the instrument automatically proceeds with the next test in the sequence.

If the visual test fails the user must evaluate if it is safe to proceed with the measurements.

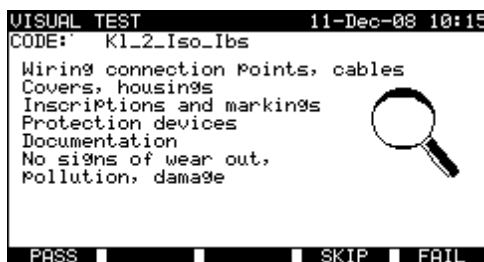

*Visual test menu*

Keys:

- PASS** (F1) Confirms that the visual inspection passed.
- SKIP** (F4) Skips visual test.
- FAIL** (F5) Ends the autotest sequence.

### 7.6.2 Continuity of the protective circuit

Measurement is described in chapter 6.3.1 *Continuity of the protective circuit*.

If the Continuity test fails or was skipped other tests will not be carried out because of safety.

Keys:

- START** Starts the Continuity measurement.  
Proceeds with the next continuity measurement (in continuous mode).  
Proceeds to the next autotest sequence measurement (in single measurement mode only).
- ENTER** Proceeds to the next autotest sequence measurement (in continuous measurement mode only).
- HELP** (F2) Displays the Continuity test help screens.
- REPEAT** (F3) Repeats the Continuity measurement.
- SKIP** (F4) Skips Continuity resistance measurement.
- END** (F5) Ends the autotest sequence.

**Note:**

- Compensation of test leads resistance should be performed before doing autotests.
- For compensation of test leads Description in chapter 6.2.1.1 *Compensation of test leads resistance* can be used as reference.

### 7.6.3 Insulation resistance (supply circuit to protective circuit)

Measurement is described in chapter 6.3.2 *Insulation resistance (supply circuit to protective circuit)*. If this insulation test fails or was skipped other tests will not be carried out because of safety.

Keys:

<b>START</b>	Starts the insulation resistance measurement. Proceeds with the next insulation resistance measurement (in continuous mode). Proceeds to the next autotest sequence measurement (in single measurement mode only).
<b>ENTER</b>	Proceeds to the next autotest sequence measurement (in continuous measurement mode only).
<b>HELP (F2)</b>	Displays the insulation resistance test help screens.
<b>REPEAT (F3)</b>	Repeats the insulation resistance measurement.
<b>SKIP (F4)</b>	Skips insulation resistance measurement.
<b>END (F5)</b>	Ends the autotest sequence.

### 7.6.4 Insulation resistance (welding circuit to protective circuit)

Measurement is described in chapter 6.3.3 *Insulation resistance (welding circuit to protective circuit)*. If this insulation test fails or was skipped other tests will not be carried out because of safety.

Keys:

<b>START</b>	Starts the insulation resistance measurement. Proceeds with the next insulation resistance measurement (in continuous mode). Proceeds to the next autotest sequence measurement (in single measurement mode only).
<b>ENTER</b>	Proceeds to the next autotest sequence measurement (in continuous measurement mode only).
<b>HELP (F2)</b>	Displays the insulation resistance test help screens.
<b>REPEAT (F3)</b>	Repeats the insulation resistance measurement.
<b>SKIP (F4)</b>	Skips insulation resistance measurement.
<b>END (F5)</b>	Ends the autotest sequence.

### 7.6.3 Insulation resistance (supply circuit to welding circuit)

Measurement is described in chapter 6.3.4 *Insulation resistance (supply circuit to welding circuit)*. If the insulation test fails or was skipped other tests will not be carried out because of safety.

Keys:

<b>START</b>	Starts the insulation resistance measurement. Proceeds with the next insulation resistance measurement (in continuous mode). Proceeds to the next autotest sequence measurement (in single measurement mode only).
<b>ENTER</b>	Proceeds to the next autotest sequence measurement (in continuous measurement mode only).
<b>HELP (F2)</b>	Displays the insulation resistance test help screens.

<b>REPEAT</b> (F3)	Repeats the insulation resistance measurement.
<b>SKIP</b> (F4)	Skips insulation resistance measurement.
<b>END</b> (F5)	Ends the autotest sequence.

### 7.6.6 Insulation resistance (supply circuit of class II equipment to accessible surfaces)

Measurement is described in chapter 6.3.5 *Insulation resistance (supply circuit of class II equipment to accessible surfaces)*. If this insulation test fails or was skipped other tests will not be carried out because of safety.

Keys:

<b>START</b>	Starts the insulation resistance measurement. Proceeds with the next insulation resistance measurement (in continuous mode). Proceeds to the next autotest sequence measurement (in single measurement mode only).
<b>ENTER</b>	Proceeds to the next autotest sequence measurement (in continuous measurement mode only).
<b>HELP</b> (F2)	Displays the insulation resistance test help screens.
<b>REPEAT</b> (F3)	Repeats the insulation resistance measurement.
<b>SKIP</b> (F4)	Skips insulation resistance measurement.
<b>END</b> (F5)	Ends the autotest sequence.

### 7.6.7 Welding circuit leakage current

Measurement is described in chapter 6.3.6 *Welding circuit leakage current*. If this leakage test fails or was skipped other tests will not be carried out because of safety.

Keys:

<b>START</b>	Starts the leakage current measurement. Proceeds with the next leakage current measurement (in continuous mode). Proceeds to the next autotest sequence measurement (in single measurement mode only).
<b>ENTER</b>	Proceeds to the next autotest sequence measurement (in continuous measurement mode only).
<b>CHG ON</b> (F1)	The instrument automatically changes L and N polarity of connected welding equipment during the test (suitable for 1-phase equipment with schuko plug). Higher measured current will be considered.
<b>CHG OFF</b> (F1)	Disables the automatic change of polarity function.
<b>HELP</b> (F2)	Displays the leakage current test help screens.
<b>REPEAT</b> (F3)	Repeats the leakage current measurement.
<b>SKIP</b> (F4)	Skips the leakage current measurement.
<b>END</b> (F5)	Ends the autotest sequence.

### 7.6.8 Primary leakage current

Measurement is described in chapter 6.3.7 *Primary leakage current*. If this leakage test fails or was skipped other tests will not be carried out because of safety.

Keys:

<b>START</b>	Starts the leakage current measurement. Proceeds with the next leakage current measurement (in continuous mode). Proceeds to the next autotest sequence measurement (in single measurement mode only).
<b>ENTER</b>	Proceeds to the next autotest sequence measurement (in continuous measurement mode only).
<b>CHG ON (F1)</b>	The instrument automatically changes L and N polarity of connected welding equipment during the test (suitable for 1-phase equipment with schuko plug). Higher measured current will be considered.
<b>CHG OFF (F1)</b>	Disables the automatic change of polarity function.
<b>HELP (F2)</b>	Displays the leakage current test help screens.
<b>REPEAT (F3)</b>	Repeats the leakage current measurement.
<b>SKIP (F4)</b>	Skips the leakage current measurement.
<b>END (F5)</b>	Ends the autotest sequence.

### 7.6.9 Touch leakage current

Measurement is described in chapter 6.3.8 *Touch leakage current*. If this leakage test fails or was skipped other tests will not be carried out because of safety.

Keys

<b>START</b>	Starts the touch leakage current measurement. Proceeds with the next touch leakage current measurement (in continuous mode). Proceeds to the next autotest sequence measurement (in single measurement mode only).
<b>CHG ON (F1)</b>	The instrument automatically changes L and N polarity of connected welding equipment during the test (suitable for 1-phase equipment with schuko plug). Higher measured current will be considered.
<b>CHG OFF (F1)</b>	Disables the automatic change of polarity function.
<b>HELP (F2)</b>	Displays the touch leakage current test help screens.
<b>REPEAT (F3)</b>	Repeats the touch leakage current measurement.
<b>ENTER</b>	Proceeds to the next autotest sequence measurement (in continuous measurement mode only).
<b>SKIP (F4)</b>	Skips touch leakage current measurement.
<b>END (F5)</b>	Ends the autotest sequence.

### 7.6.10 No load voltage

Measurement is described in chapter 6.3.9 *No load voltage*. If this voltage test fails or was skipped other tests will not be carried out because of safety.

Keys

<b>AC/ DC (F1)</b>	The instrument sets appropriate limit values – depends on the welding machine's operating mode.
<b>START</b>	Starts the No load voltage measurement.
<b>ENTER</b>	Proceeds to the next autotest sequence measurement.
<b>HELP (F2)</b>	Displays the no voltage test help screens.
<b>REPEAT (F3)</b>	Repeats the no voltage measurement.

**SKIP** (F4)        Skips leakage current measurement.  
**END** (F5)        Ends the autotest sequence.

### **7.6.11 TRMS current measurement using clamp current adapter**

Refer to chapter 6.2.9 *TRMS current measurement using clamp current adapter* for reference.

### **7.6.12 Functional test**

Refer to chapter 6.2.11 *Power / Functional test* for reference.

## 8 Working with autotest results

After the autotest sequence is completed, measurement results can be:

- Saved to the flash memory of the instrument. Before that they can be viewed and edited. Refer to chapter 8.1 *Saving autotest results* for more information.
- Send to PC or a test report can be printed out to serial printer. Refer to chapter 8.4 *Downloading and printing results* for more information.
- DUT label can be printed out. Refer to chapter 8.4 *Downloading and printing results* for more information.

### 8.1 Saving autotest results

After the autotest sequence is completed, **Save results** menu is displayed.

Following data can be added to the test results for saving:

- Device number and its name
- Test site and location,
- Retest period,
- Repairing code,
- Comments.

```

SAVE RESULT                               18-May-09 12:53
-----
DEVICE No.: █
TEST SITE: BUILDING 1
LOCATION: ROOM 1
USER: USER 1
-----
DEVICE NAME : DLM562
RETEST PERIOD : 12
REPAIRING CODE: 67
COMMENTS: /
-----
SAVE  UNDO  SEND  VIEW

```

Save results menu

Keys:

▼ / ▲	Selects the item.
◀ / ▶, alphanumeric	Edits data
<b>SAVE</b> (F1)	Saves test results and returns to last autotest menu.
<b>UNDO</b> (F2)	Undo changes.
<b>SEND</b> (F3)	Sends results to printer, RFID reader/writer.
<b>VIEW</b> (F4)	Views test results.
<b>LIST</b> (F5)	Enters list of pre-defined names.
<b>ESC</b>	Returns to Main menu.

In the **DEVICE No.** field up to 10 numeric characters can be entered. The **device number** can also be scanned with a barcode reader.

In the **Test site**, **Location** and **DEVICE NAME** fields, up to 15 alpha-numeric or special characters can be entered. Names can also be selected from the list of 100 predefined names for each parameter.

In **Retest period** field, the number of retest period in months can be entered.

In **Repairing code** field, up to 20 alpha-numeric or special characters can be entered.



In the **Comments** field, up to 25 alpha-numeric or special characters can be entered. All parameters added to the autotest results have, in general, a possibility to be replicated or default set to blank when saving new autotest results. Device number can also be automatically incremented when new autotest sequence is finished. For detailed description refer to chapter 5.9.1 *Instrument settings*.

All test results can be viewed before saving by pressing **VIEW** (F4) key. *View results menu* will be displayed. To return to previous menu **ESC** key should be pressed.

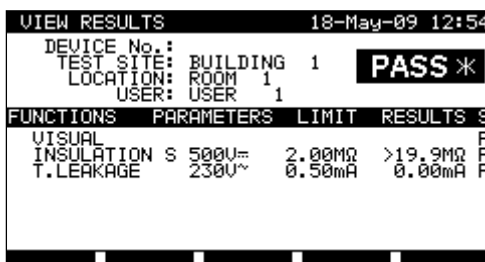

FUNCTIONS	PARAMETERS	LIMIT	RESULTS	S
INSULATION	500U=	2.00MΩ	>19.9MΩ	P
T.LEAKAGE	230U~	0.50mA	0.00mA	P

*View Project autotest results menu*

#### Notes:

- The date and time are automatically attached to the saved results.
- The autotest results cannot be stored if the Device no. field is empty.
- User** field cannot be edited (this must be selected from the *User/ Device data menu* of the instrument).

## 8.2 Recalling results

Select **Recall/delete/send memory** in *Main menu* by using  $\wedge$  and  $\vee$  keys and press ENTER key to confirm. **Search results** menu is displayed.

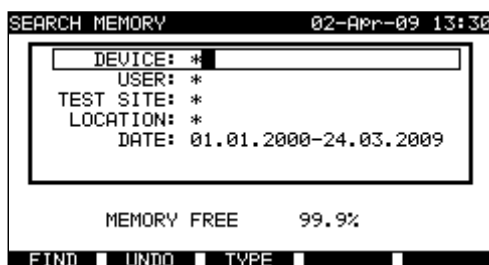

DEVICE: *
USER: *
TEST SITE: *
LOCATION: *
DATE: 01.01.2000-24.03.2009
MEMORY FREE 99.9%
FIND UNDO TYPE

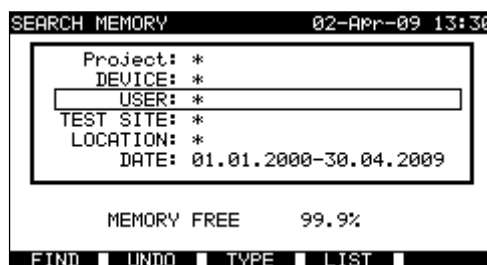

Project: *
DEVICE: *
USER: *
TEST SITE: *
LOCATION: *
DATE: 01.01.2000-30.04.2009
MEMORY FREE 99.9%
FIND UNDO TYPE LIST

*Search results menus*

When searching for stored results the following filters can be used to narrow the hits:

- DUT number or project No. (for machine and switchgear testing)
- Test site,
- Location,
- Date from and date to,
- User.

By using  $\wedge$  and  $\vee$  cursor keys select the filter you want to edit.

## Keys:

▼ / ▲	Selects parameter line.
◀ / ▶, Alphanumeric	Edits parameter line.
<b>FIND</b> (F1)	Starts search after filters are set correctly.
<b>UNDO</b> (F2)	Undo latest change.
<b>TYPE</b> (F3)	Selects parameter line type.
<b>ESC</b>	Returns to Main menu.

## Notes:

- To change the selected parameter line type, press the F3 function key and the »parameter type« will become highlighted (e.g. DEVICE). The cursor keys ◀ and ▶ can then be used to change the parameter type and by pressing **ENTER** key the choice can be confirmed. Once the parameter types have been set up, the data required to filter the results can be inserted. Filter information can be inserted via the alphanumeric keypad or, in some filter fields such as user, can also be selected from a predefined list by pressing the F4 function key. The device number field can also be read using a barcode reader.
- By placing a »\*« (shift + "2") in a particular field, tells the instrument not to search the associated filter field. When searching, the instrument will therefore ignore data in this parameter and go on to find all the DUTs that conform to data placed in the other filter fields.
- To find all stored results, enter »\*« in the all fields (excluding DATE where the correct from and to dates must be entered).

When the search filters have been correctly set up, a search can be performed by pressing the F1 function key. If the search filters are set up correctly and the DUTs exist in the units memory, the **Recall memory menu** will be displayed.

While recalling stored results, the instrument shows a bargraph and a ratio of files found compared to files stored in memory (e.g. 7/11 implies 7 results have been found to meet the filter criteria out of a potential 11 results stored in the flash memory).

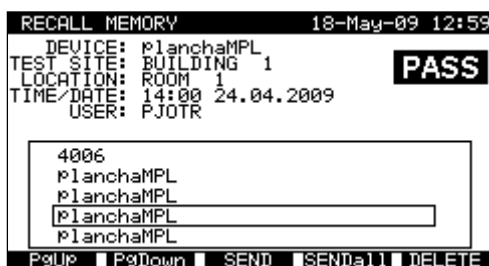

*Recall memory menu*

Once the DUTs have been found, the ▲ and ▼ cursor keys and F1 and F2 function keys can be used to scroll through the list of DUTs.

More information relating to a DUT can be viewed by pressing the **ENTER** key on the appropriate DUT. The information can be scrolled using the F1 and F2 function keys and the F5 function key can be used to switch between different DUT data views.

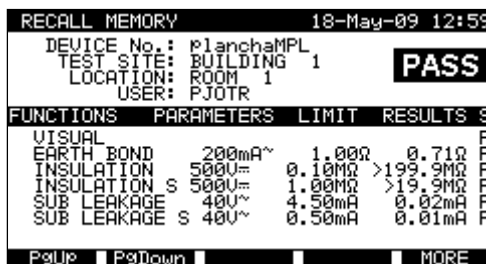

View results menu

Use the **ESC** key to return to **Recall memory** or **Search results menus**. From the **Recall memory menu** stored data can be downloaded to a PC, printed out to a serial printer or deleted from the memory. Refer to chapters 8.4 *Downloading and printing results* and 8.3 *Deleting results*, respectively.

### 8.3 Deleting results

Stored autotest results can also be deleted from the memory.

Enter **Recall/delete/send memory menu** from **[PAT, Machine, Switchgear, All tests] testing menu**. Recall the result(s) you want to delete (Refer to chapter 8.2 *Recalling results* for detailed information on recalling results).

In the **Recall memory** menu, press the F5 function key. **Delete** menu will be displayed. In this menu the following functions can be performed.

- DELETE: Deletes the single file last highlighted when the F5 function key was pressed,
- DELETE SELECTED: Deletes all the files found from searching the memory of the instrument,
- DELETE ALL: Clears all stored test data from the instrument.

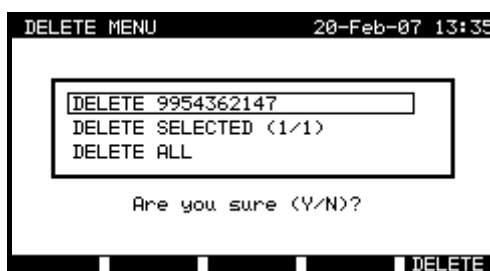

Delete results menu

Keys:

▼ / ▲	Select deleting option.
<b>DELETE (F5)</b>	Enters the confirmation menu for deleting selected results.
<b>ESC</b>	Returns to Recall memory menu.

Confirm the delete activity by using Y key. After performing the selected option, instrument returns to **Recall memory** menu accepting the new memory state. If you don't want to delete the results, press the N key in **Delete** menu. Instrument returns to **Recall memory** menu without any changes.

### 8.4 Downloading and printing results

The instrument offers the following possibilities to send selected result or selection to:

- PC (to store and later operations on stored results),
- Serial printer for fast report printing,
- Label printer, and
- RFID tag (only one result).

It is possible to send data to selected output after:

- Autotest sequence is completed, or
- Recalling stored results from the instrument memory.

By pressing the **SEND** (F3) key or **SENDall** (F4) in the *Recall memory* or *Save results menus*, *Send results* menu is available.

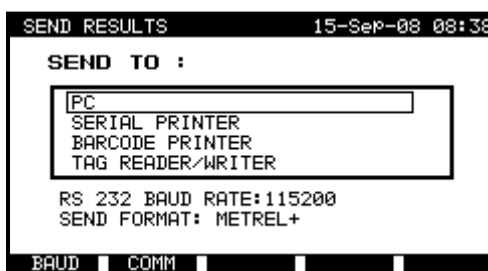

Send results menu

Keys:

▼ / ▲	Selects activity.
<b>ENTER</b>	Starts sending to selected output.
<b>ESC</b>	Returns to <i>Recall memory</i> or <i>Save results</i> menu.

#### Send to PC

Keys:

<b>BAUD</b> (F1)	Opens menu for selection of Baud Rate.
<b>COMM</b> (F2)	Opens menu for interface selection (RS232 or USB)

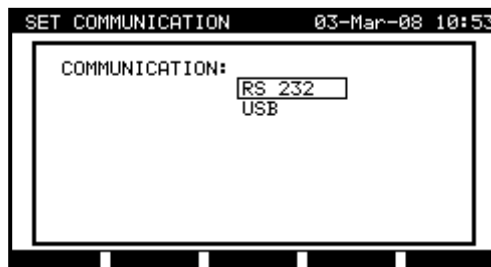
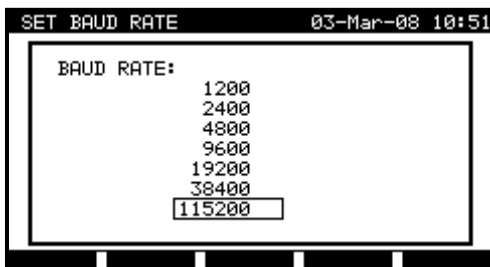

Communication ports settings

Keys:

▼ / ▲	Selects the option.
<b>SAVE</b> (F1)	Saves selected option.
<b>ESC</b>	Returns to <i>Send results</i> menu.

## Send to serial printer

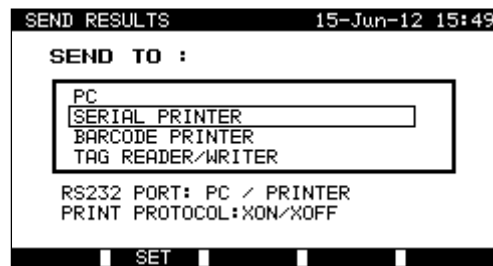

*Send to serial printer menu*

Keys:

<b>SET (F2)</b>	Opens menu for selection of data transfer control option.
-----------------	---

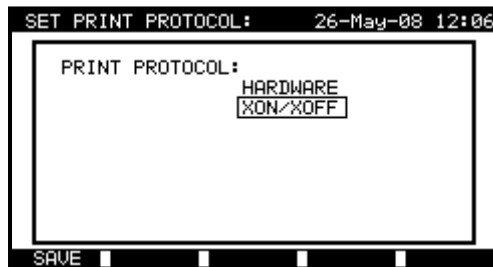

*Serial printer settings*

Keys:

<b>▼ / ▲</b>	Selects the option.
<b>SAVE (F1)</b>	Accepts selected option.
<b>ESC</b>	Returns to <i>Send results</i> menu.

```

.....
METREL
Testing laboratory
Horjul, Slovenia
.....

DEVICE 11072010
TEST SITE METREL
LOCATION OFFICE 1
TIME/DATE 09:31 11-JUL-2008
USER TOMAZ
RESULT: PASS

-----
VISUAL PASS
EARTH BOND It: 10A~ Rlim: 0.10 Ohm
1. R = 0.03 Ohm PASS
INSULATION Ut: 500V Rlim: 1.00 MOhm
1. R = 178.9 MOhm PASS
LEAKAGE Ut: 230V~ Ilim: 0.75 mA
1. I = 0.23 mA PASS
POWER
1. P = 2.01KVA PASS
DEVICE NAME: APP 1
RETEST PERIOD : 11/07/2009
REPAIRING CODE: 021268505
COMMENTS: -
=====
==

```

END OF DATA

```

PRINT HEDER FOR MPL TESTING
2ND LINE
LAST HEADER LINE

      DEVICE                planchaMPL
TEST SITE                BUILDING 1
LOCATION                  ROOM 1
TIME/DATE                14:00 24-APR-2009
USER                    PJOTR
RESULT:                  PASS

-----
VISUAL                  PASS
EARTH BOND      It:200mA~ Rlim: 1.00 Ohm
1. R =                0.71 Ohm PASS
INSULATION      Ut: 500V Rlim: 0.30 MOhm
1. R =                >199.9 MOhm PASS
INSULATION S    Ut: 500V Rlim: 1.00 MOh
1. R =                >19.9 MOhm PASS
SUB LEAKAGE     Ut: 40V~ Ilim: 4.50 mA
1. I =                0.02 mA PASS
SUB LEAKAGE     Ut: 40V~ Ilim: 0.50 mA
1. I =                0.01 mA PASS
DEVICE NAME     : plancha MPL 001
RETEST PERIOD  : 24/04/2010
REPAIRING CODE: plancha
COMMENTS:VSE OK

=====
END OF DATA

```

An example of data sent to serial printer

**Notes:**

- When working with serial printers, the baud rate is set by default to 9600 bps.
- Software transfer control uses XON (CTRL-Q) and XOFF (CTRL-S) characters.
- Hardware transfer control uses DTR line.
- Back side port supports only (XOn/XOff) software transfer control.

**Send to barcode printer**

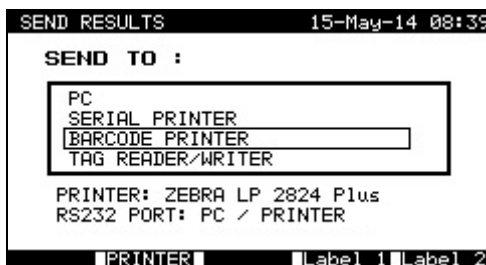

Send to barcode printer menu

Keys:

<b>PRINTER</b>	Selects label printer.
<b>Label 1 (F4)</b> <b>ENTER</b>	Prints one label (for the DUT)
<b>Label 2 (F5)</b>	Prints two labels.



Select label printer menu

Keys:

<b>▼ / ▲</b>	Selects the printer.
<b>SAVE (F1)</b> <b>ENTER</b>	Accepts selected printer.
<b>ESC</b>	Returns to <i>Send results</i> menu.

Refer to chapter 8.6.1 *Instrument settings* and **Appendix B** for detailed information about barcode systems used when printing barcode labels.

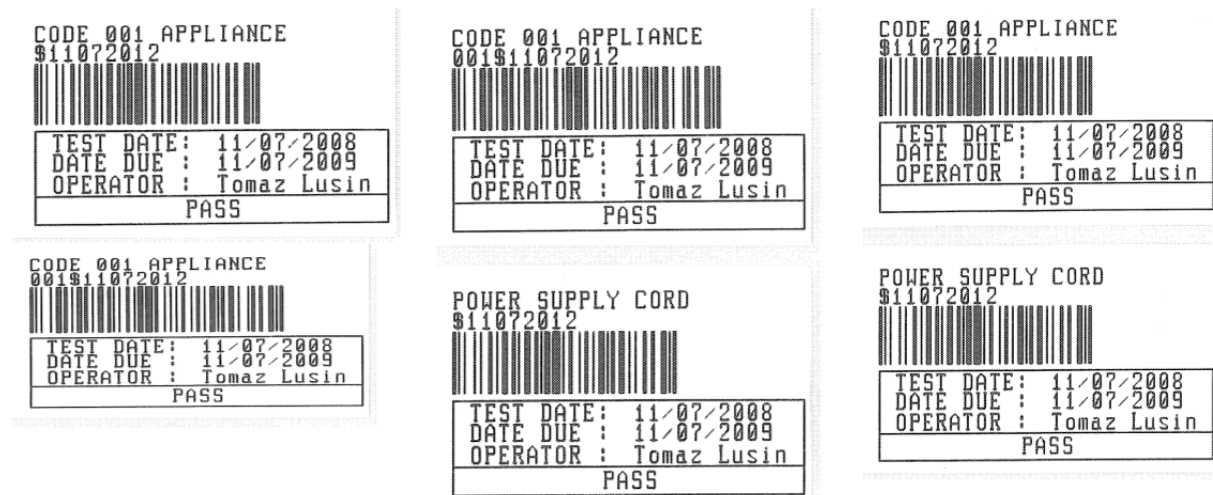

1 tag, barcode system: single (top label)  
 1 tag, barcode system: double (bottom label)  
 2 tags, barcode system: double  
 2 tags, barcode system: single

Examples of DUT labels

## Send to RFID tag

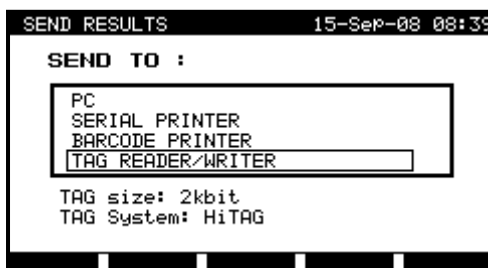

*Send to tag menu*

Keys:

<b>ENTER</b>	Sends data to the RFID tag.
<b>ESC</b>	Returns to <i>Send results</i> menu.

## 8.5 Data upload / download

Autotests and results from PC software can be uploaded to the instrument from the **Data upload / download menu**. Also the following items can be downloaded and edited or created with PC software and then uploaded onto the instrument:

- Users,
- DUTs,
- Test sites / buildings,
- Locations / rooms.



*Downloading / uploading test data menu*

During the data transfer from the PC to the instrument, the transfer status will be displayed.

Pressing ESC key instrument returns to **Main menu**.

For detailed information on data uploading / downloading refer to help menus of PC software PATLink PRO.



## 8.6 Setup menu

### 8.6.1 Instrument settings

When an autotest is completed, different data about DUT and other associated data can be added to the autotest results before saving them. In the **Instrument settings** sub-menu (**Setup** in the **PAT TESTING** menu), the settings about data changes between tests can be controlled.

The following data can be controlled between tests:

- DUT number,
- test site,
- location,
- user,
- DUT name,
- retest period
- repairing code,
- comments,
- barcode system,
- save and print.

From the **Main menu**, select **Setup** and then select **Instrument settings** by using  $\uparrow$  and  $\downarrow$  cursor keys and press ENTER key to confirm. The **Instrument settings submenu** will be displayed.

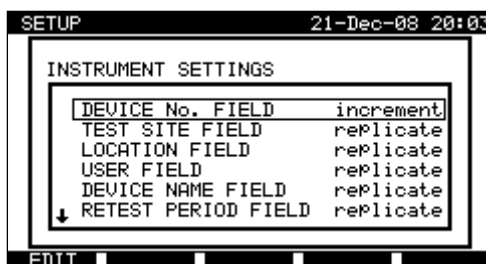

*Instrument settings menu*

Keys:

$\downarrow$ / $\uparrow$	Select the item whose parameter will be changed.
<b>EDIT (F1)</b>	Highlight the parameter that can be changed.
<b>ENTER</b>	
<b>ESC</b>	Returns to main settings menu.

### Changing the instrument parameter

The selected parameter is highlighted.

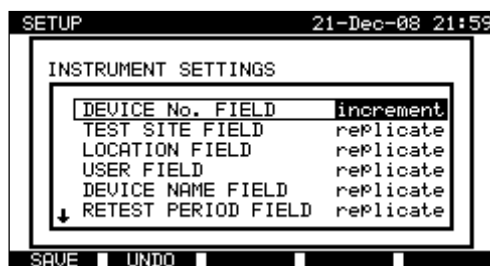

*Modification of selected setting*

**Keys:**

▼ / ▲	Modify highlighted parameter.
<b>SAVE</b> (F1)	Saves setting of selected item,
<b>UNDO</b> (F2)	Recovers currently modified setting.
<b>ESC</b>	Returns to main settings menu.

**Notes:**

- If blank is selected for a particular item, then the appropriate field will initially appear blank in the Save results menu.
- If replicate option is selected for a particular item, the last entered data will initially appear in an appropriate field when new autotest sequence is finished.
- The increment option can also be set in the device number field. In this case, the DUT number will be automatically incremented when new autotest sequence is finished.
- Special character »\$« between autotest shortcut code and DUT name (ID number) is used to distinguish shortcut code from DUT name.
- Only DUT ID is printed out on the 2<sup>nd</sup> DUT label (power supply cord label).
- Refer to Appendix B for more information about barcode systems.

## 9 Machine testing operating mode

The Machine testing operating mode is primarily intended for testing of electrical safety of machines according to the standard IEC/ EN 60204.

After entering the **Machine testing menu** following options are displayed:

Single test menu (see 9.1),  
Memory operations (see 9.2),

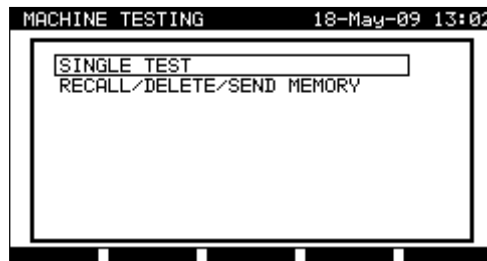

Main menu

Keys:

▼ / ▲	Selects the operating mode.
ENTER	Enters selected mode.

Note:

- Press ESC key one or more times to return to Machine testing main menu from any submenu

### 9.1 Single tests (machine testing) menu

The measurements and their parameters in this menu are suited for verification of machines.

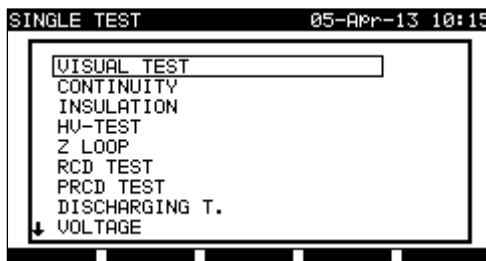

Single test menu

Keys:

▼ / ▲	Select the test / measuring function: <Visual test> Visual inspections, <Continuity test> Continuity of protective conductors tests, <Insulation> Insulation resistance, <HV- test> High Voltage tests, <Z Loop> Loop impedance tests, <RCD test> Tests of residual current devices, <PRCD test> Tests of portable residual current devices, <Discharging time> Discharging time tests, <Voltage> Voltage, frequency and rotary field tests, <Functional test> Functional inspection.
-------	---

<b>ENTER</b>	Enters selected test.
<b>ESC</b>	Returns to Main menu.

**Note:**

- Unlike in PAT testing mode all single test results and parameters can be stored for documentation purposes (view *chapter 12.1* for more information).

## 9.2 Measurements and inspections

### 9.2.1 Visual test

Visual check is the most important and effective part of a machine test.

Electrical testing often does not disclose failures that become apparent on visual inspection. A visual check must be carried out before each electrical safety test. Following items should be checked:

- Wiring connection points. Especially PE connections are important!
- Protection covers, housings.
- Inscriptions and markings related to safety must be clearly readable.
- Cable layout, radiuses, isolation.
- Switches, regulators, lamps, keys.
- Parts subjected to wear out.
- Electrical and mechanical protection devices (barriers, switches, fuses, alarms).
- Openings, filters.
- Technical documentation, availability of instructions for use.
- Installation of the DUT must be performed according to the user manuals.

During visual inspection the measuring points for the electrical testing have to be determined too.

Check that there are no signs of:

- Damage,
- Pollution, moisture, dirt that can influence the safety,
- Corrosion,
- Overheating.

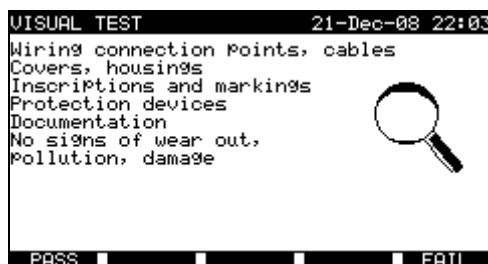

*Visual test menu*

### Visual test procedure

- Select the **VISUAL TEST** function.
- Perform visual **inspection** of the machine.
- Commit **PASS** or **FAIL** ticker manually (with **PASS** (F1), **FAIL** (F5) keys).
- Save result (optionally) with **SAVE** (F4) key.



Examples of visual test measurement results

### 9.2.2 Continuity

This test determines that the PE and equipotential connections inside the machine have proper resistance that corresponds to their length and cross-section.

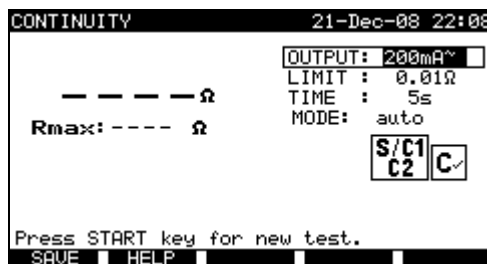
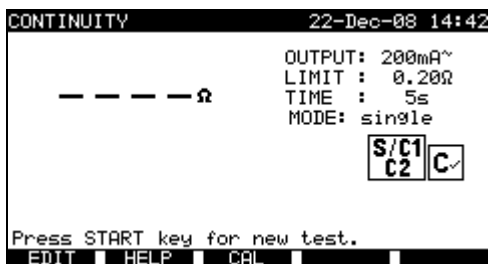

Continuity menus

#### Test parameters for Continuity measurement

OUTPUT	Test current [200 mA, 10 A]
LIMIT	Maximum resistance [0.01 Ω ÷ 0.09 Ω, 0.10 Ω ÷ 0.90 Ω, 1.00Ω ÷ 9.00 Ω]
TIME	Measuring time [5 s, 10 s, 30 s, 60 s, 120 s, 180 s]
MODE	Operation mode [single, auto]

**Test circuit for Continuity measurement**

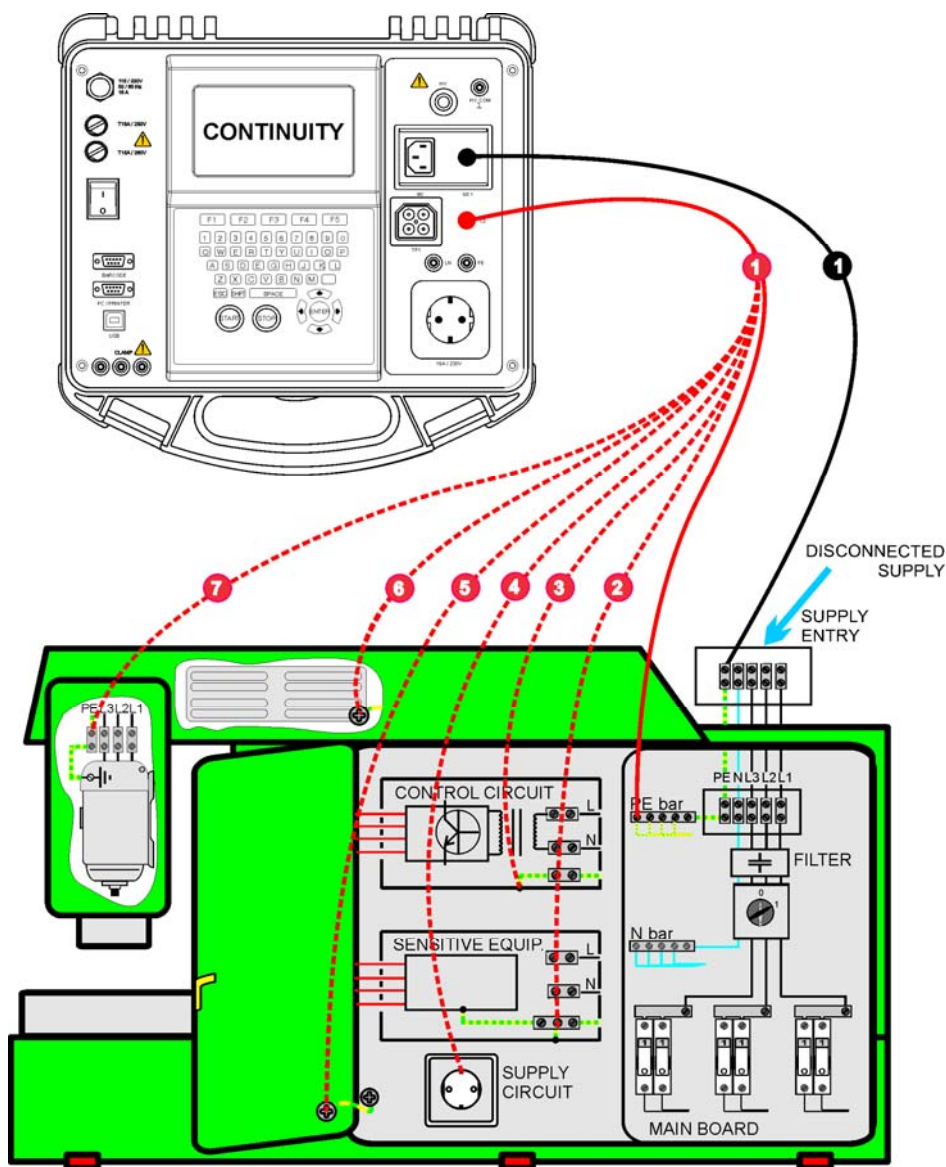

*Measurement of continuity of protective conductors of machines*

**9.2.2.1 Single continuity test**

In the single continuity test the continuity of individual connections can be determined.

**Continuity measurement procedure**

- Select the **CONTINUITY** function.
- Set test **parameters**
- Make sure that the test leads are calibrated. **Compensate** them if necessary (See chapter 9.2.2.3 *Compensation of test leads resistance* for more information).
- Connect** test leads to S/C1 and C2 terminals on the instrument.
- Connect** test leads to both ends of protective conductor under test.
- Press the **START** key for measurement.
- Press **SAVE** (F4) key for storing the result (optional).

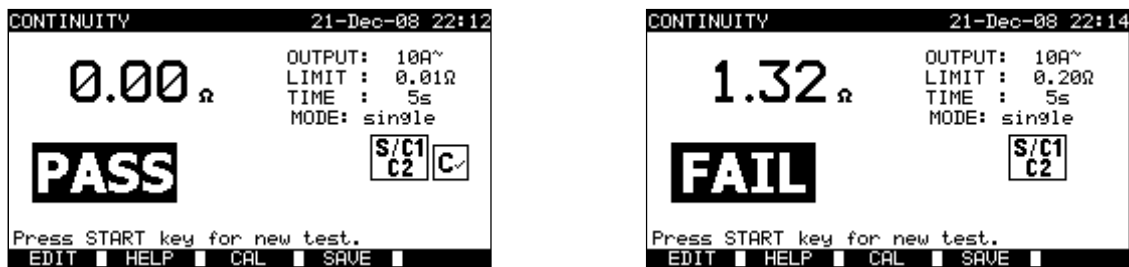

Examples of continuity measurement results

Displayed results:

Main result ..... Continuity

#### Notes:

- Consider displayed warnings before starting measurement!
- For more information how to calibrate the test leads see *chapter 9.2.2.3*.

#### 9.2.2.2 Auto-continuity test

In the auto continuity test mode up to 30 continuity tests can be performed and stored in one step. Additional features are:

- Connection of test leads to a low resistance connections is detected and the measurements starts/ stops automatically,
- Sound warnings are indicating the actual phase of the measurement.
- The autotest is useful if testing large machines with a lot of PE connection points.
- The user does not need to return to the instrument and pressing START/STOP/SAVE keys for each individual measurement. The test can easily be carried out by one person even if testing with long test leads on large machines.

#### Continuity measurement procedure

- Select the **CONTINUITY** function.
- Set test **parameters**.
- Make sure that the test leads are calibrated. Calibrate them if necessary (See chapter 9.2.2.3 Compensation of test leads resistance for more information).
- Connect** test leads to S/C1 and C2 terminals on the instrument.
- Press the **START** key for measurement. The instrument is monitoring for a low resistance between the test leads is detected.
- Connect** test leads to both ends of the first PE connection under test. The instrument detects (double beep) the low resistance and starts first measurement.
- After the timer elapse the instruments temporarily stores the first result. A sound signal (short beeps) indicates that the first measurement is concluded and temporarily stored. The results displayed in this phase will not be stored.
- Disconnect** test leads and proceed to the next measuring point (no beep).
- Connect** test leads to both ends of the second PE connection under test. The instrument detects (double beep) the low resistance and starts second measurement.
- After the timer elapse the instruments temporarily stores the second result. A sound signal (continuous short beeps) indicates that the second measurement is concluded and temporarily stored. The results displayed in this phase will not be stored.

- ❑ **Disconnect** test leads and proceed to the next measuring point. (no beep)  
.....  
.....
- ❑ **Connect** test leads to both ends of the last PE connection under test. The instrument detects (double beep) the low resistance and starts last measurement.
- ❑ After the timer elapse the instruments temporarily stores the last result. A sound signal (short beeps) indicates that the last measurement is concluded and temporarily stored. The results displayed in this phase will not be stored.
- ❑ **Disconnect** test leads (no beep).
- ❑ Press **STOP** key to stop the measurement.
- ❑ Press **SAVE** (F4) key for storing the results (optional). All temporarily stored results are saved into the instruments memory.

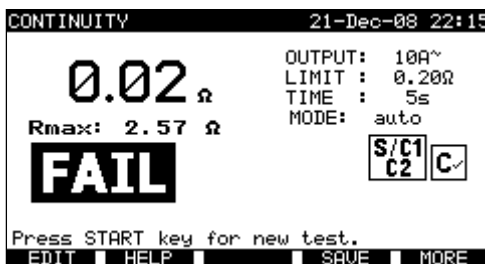

Example of continuity measurement results – normal view

Displayed results:

Main result ..... actual measured resistance / last measurement result

Rmax ..... highest measured resistance

By pressing the MORE (F5) key all measured results can be seen.

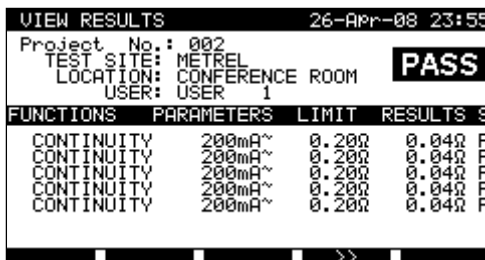

Examples of continuity resistance measurement results – all results view

Displayed results:

Main result ..... actual measured resistance

Rmax ..... highest measured resistance

Sub-results (1., 2., ...n) ..... temporarily stored individual results

By pressing the BACK (F5) key the instrument returns to normal view.

**Notes:**

- ❑ Consider displayed warnings before starting measurement!
- ❑ STOP key can be pressed anytime during the measurement. All concluded measurements are internally stored and can be saved to the instrument’s memory.
- ❑ Optional external buzzer A1421 can be used in the Auto-continuity test.



### 9.2.2.3 Compensation of test leads resistance

Test leads compensation is required to eliminate the influence of test leads resistance and instrument's internal resistance. If a compensation value is stored this is indicated in the message .

#### Circuit for compensating the resistance of test leads

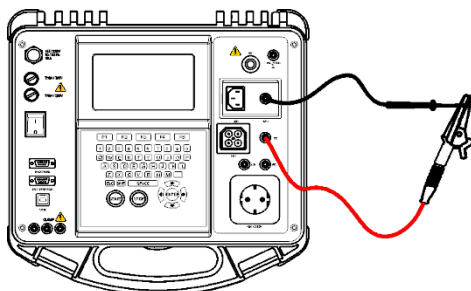

*Shorted test leads*

#### Compensation of test leads resistance procedure

- Select the **CONTINUITY** function
- Select the **Single mode** test
- Connect** test cable to the instrument and short test leads (see figure above).
- Press the **CAL** (F3) key for measurement.
- If the calibration was performed successfully, 0.00  $\Omega$  is displayed.

#### Notes:

- 5  $\Omega$  is the limit value for resistance compensation. If the resistance is higher then the calibration value is reset to the default value and the message disappears.
- Both 10 A and 200 mA continuity functions are compensated at the same time.
- The lead compensation is very important to obtain correct result especially if long test leads are used.

### 9.2.3 Insulation resistance

Insulation resistance between live conductors and accessible (earthed or isolated) metal parts is checked. This test discloses faults caused by pollution, moisture, deterioration of insulation metal etc.

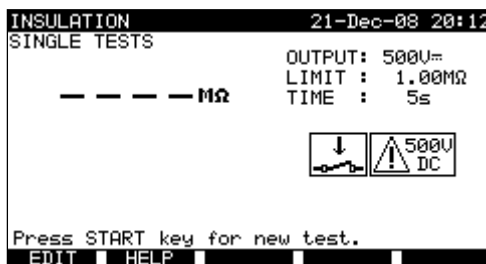

*Insulation resistance menu*

**Test parameters for insulation resistance measurement**

OUTPUT	<b>Test voltage</b> [250 V, 500 V]
LIMIT (Insulation)	<b>Minimum resistance</b> [0.10 MΩ, 0.30 MΩ, 0.50 MΩ, 1.00 MΩ, 2.00 MΩ, 4.00MΩ, 7.00 MΩ, 10.00 MΩ, none]
TIME	<b>Measuring time</b> [5 s, 10 s, 30 s, 60 s, 120 s, none]

**Test circuits for insulation resistance measurement**

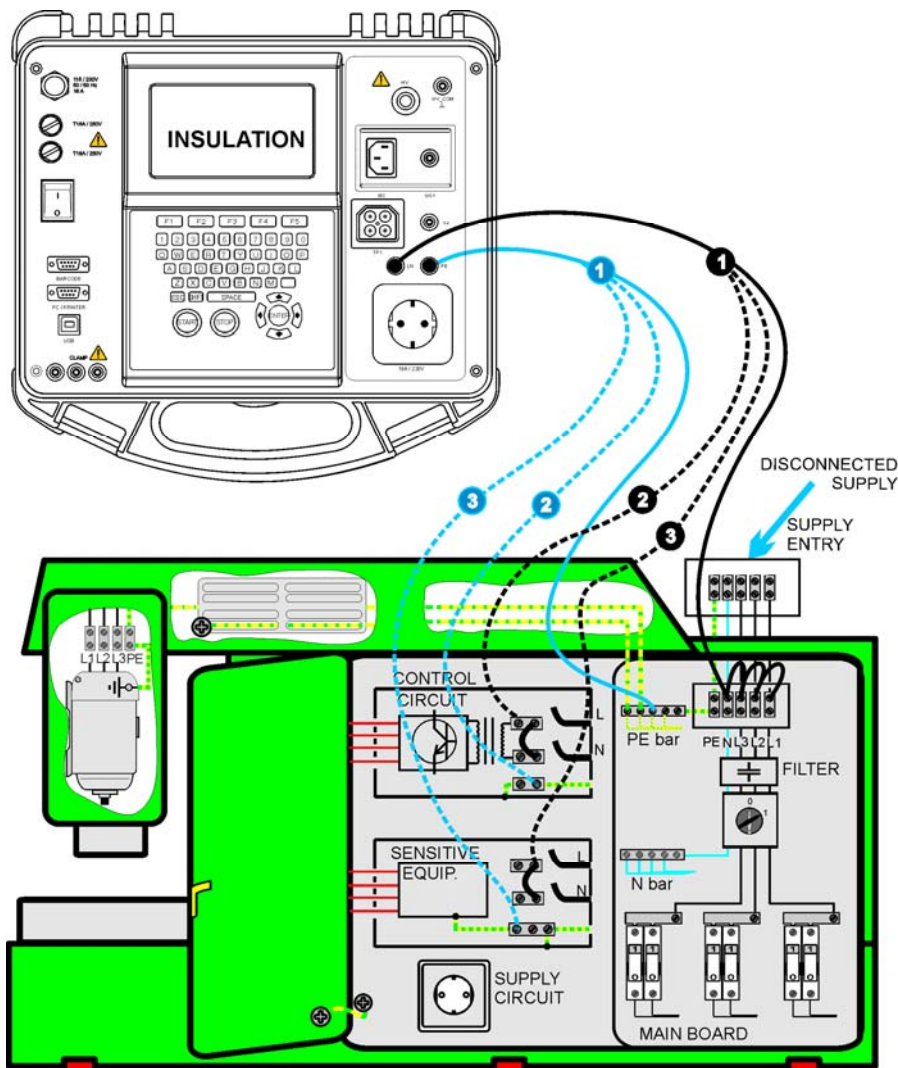

*Measurement of insulation resistance*

**Insulation resistance measurement**

- Select the **Insulation** single test.
- Set test **parameters**
- Connect** test leads to LN and PE terminals on the instrument.
- Connect** the LN test lead to the (temporarily connected) L and N terminals of the machine.
- Connect** the PE test lead to a PE terminal of the machine.
- Press the **START** key for the measurement.
- Press **SAVE** (F4) key for storing the result (optional).



Examples of insulation resistance measurement results

Displayed results:

Main result ..... insulation resistance

#### Notes:

- The machine under test should be de-energized before the measurement!
- Consider any warning on the display before starting the measurement!
- Care must be taken if machine includes sensitive electrical equipment that could be damaged if to high test voltage would be applied to them.
- In this case the sensitive part should be disconnected from the tested circuitry. Depending on the product standard, they should be tested with an appropriately lower test voltage.
- If surge protection devices are installed the test can be carried out only in a limited manner.
- Do not disconnect the machine under test from the instrument during the measurement or before it is automatically discharged! The message »Discharging...« is displayed while the voltage on DUT is higher than 20 V!
- Do not forget to remove the L-N link after the tests.

### 9.2.4 High Voltage withstanding test

The High Voltage withstanding test is used to confirm integrity of the insulation materials. During the test the insulation materials in the machine are stressed with a higher voltage than during normal operation. A powerful AC high voltage source is applied between the live/ neutral input terminals and the metal housing of the machine. The instrument trips out if the leakage current exceeds the predefined limit.

#### **⚠ IMPORTANT SAFETY NOTES**

- As a dangerous voltage of over 1000 V AC is applied at the HV instrument outputs special safety consideration must be taken when performing this test!**
- Disconnect all unused test leads before starting this measurement; otherwise the instrument can be damaged!**
- Only a skilled person familiar with hazardous voltages can perform this measurement!**
- Do not perform this test if any damage or abnormality (test leads, instrument) is noted!**
- Never touch exposed probe tip, connections equipment under test or any other energized part during the measurements. Make sure that NOBODY can contact them either!**
- Connect test probes only for the High Voltage test and disconnect them immediately after the test!**

- ❑ Do not touch any part of test probe in front of the barrier (keep your fingers behind the finger guards on the probe) – possible danger of electric shock!
- ❑ Always use lowest possible trip-out current.

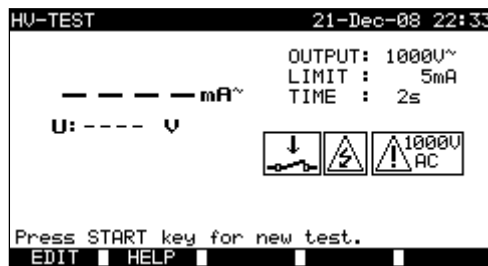

High Voltage withstanding menu

**Test parameters for high voltage withstanding test**

OUTPUT	Test voltage [1000 V]
LIMIT	Trip out current [5 mA, 10 mA, 20 mA, 50 mA, 100 mA, 200 mA]
TIME	Measuring time [2 s, 3 s, 5 s, 10 s, 30 s]

**Test circuit for high voltage withstanding test**

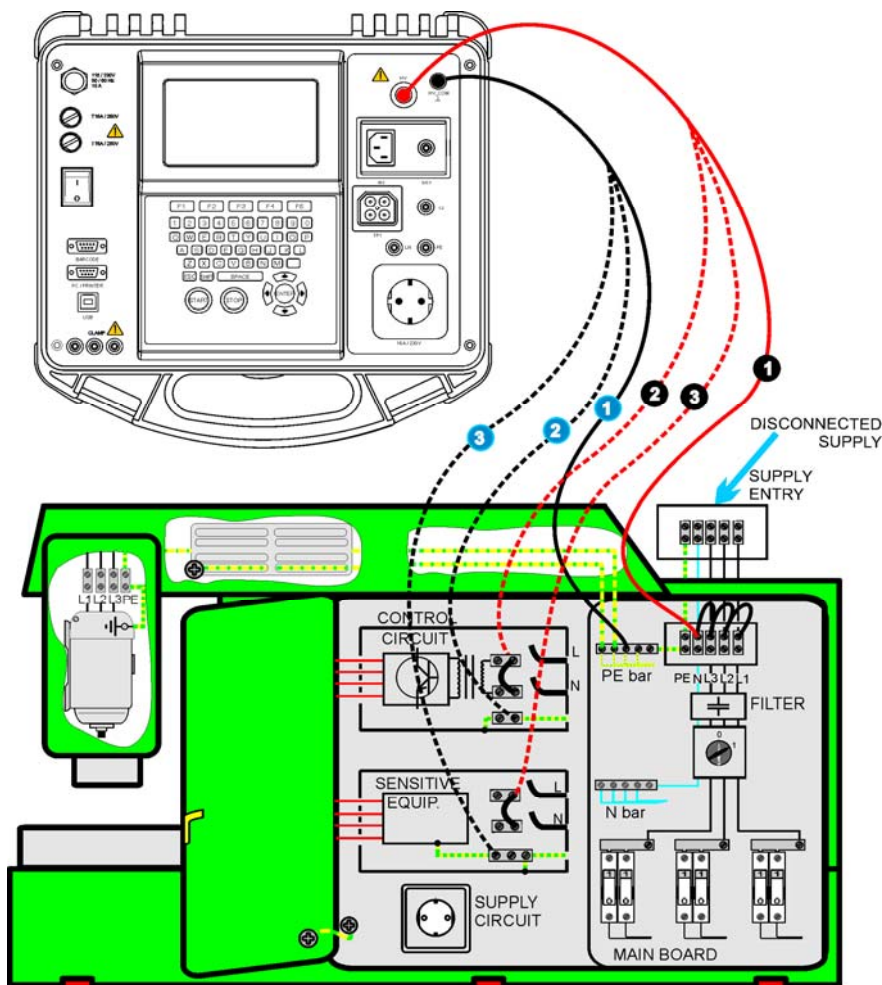

High voltage withstanding test

### High voltage withstanding test procedure

- Select the **HV-test** single test.
- Set test **parameters**
- Connect** test leads to HV and HV\_PE terminals on the instrument.
- Connect** the HV test lead to the to L and N terminals of the machine (L and N terminals should be temporarily connected).
- Connect** the PE test lead to a PE terminal of the machine.
- Press and hold the START key for the measurement.
- If the test current exceeds the set trip out current the measurement is stopped immediately.
- The measurement is stopped immediately after the START key is released.
- Press SAVE (F4) key for storing the result (optional).

### Instructions for using the test probe

- Push the button on the probe to unlock the sleeve and touch tested object with test tip (keep the button pushed while the sleeve is not retracted upon few millimeters at least, than release it and retrieve the thumb behind the barrier).
- After the measurement retract the test tip from tested object and sleeve comes automatically over the tip.
- The sleeve locks itself automatically when it fully recovers the tip.



Examples of high voltage withstanding test results

Displayed results:

Main result ..... leakage current

Sub-result: ..... applied voltage

### Notes:

- The machine should be de-energized before the measurement!
- Components and devices that are not rated to withstand the test voltage shall be disconnected during the testing.
- Components and devices that have been voltage tested in accordance with their product standards may be disconnected during testing.
- Consider any warning on the display before starting the measurement!
- If HV\_PE test probe is not connected, the test will not be started or will be interrupted. "Test lead disconnected" warning will be displayed.
- Do not forget to remove the L-N links after the tests.

### 9.2.5 Loop impedance and prospective fault current

The instrument measures the impedance of the fault loop and calculates the prospective fault current. The results can be compared to limit values set on base of selected protective circuit breakers or RCDs. The measurement complies with requirements of the standard EN 61557-3.

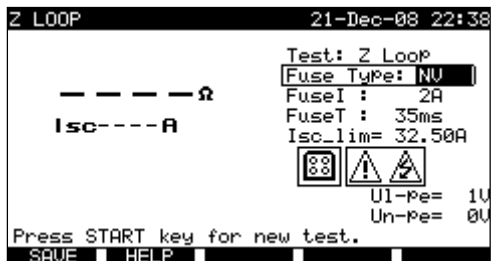

Loop impedance menu

#### Test parameters for fault loop impedance measurement

TEST	Type of test based on installed protective device: [Zloop, Zs(rcd)*, Rs(rcd)*, Z mΩL-Pe*** ]
Fuse type	Selection of <b>Fuse type</b> [*F, NV, gG, B, C, K, D] **

For Z LOOP, Zs(rcd), Z mΩL-Pe

Fuse I	<b>Rated current</b> of selected fuse
Fuse T.	Maximum <b>breaking time</b> of selected fuse
Isc_lim	Minimum short circuit <b>current</b> for selected fuse combination.

For Rs(rcd)

RCD/Fi	Selection of <b>RCD nominal current size</b> [10 mA, 30 mA, 100 mA, 300 mA, 500 mA, 1000 mA]
R Lim	<b>Limit</b> resistance value for selected RCD nominal current.

See Appendix C for reference fuse data.

\* Zs(rcd) and Rs(rcd) tests will NOT trip-out the RCD in RCD protected machine/ installation.

\*\* »\*F« means no fuse selected.

\*\*\* See *chapter 9.2.5.1* for Z mΩL-Pe, high precision loop impedance measurement.

**Test circuit for fault loop impedance measurement**

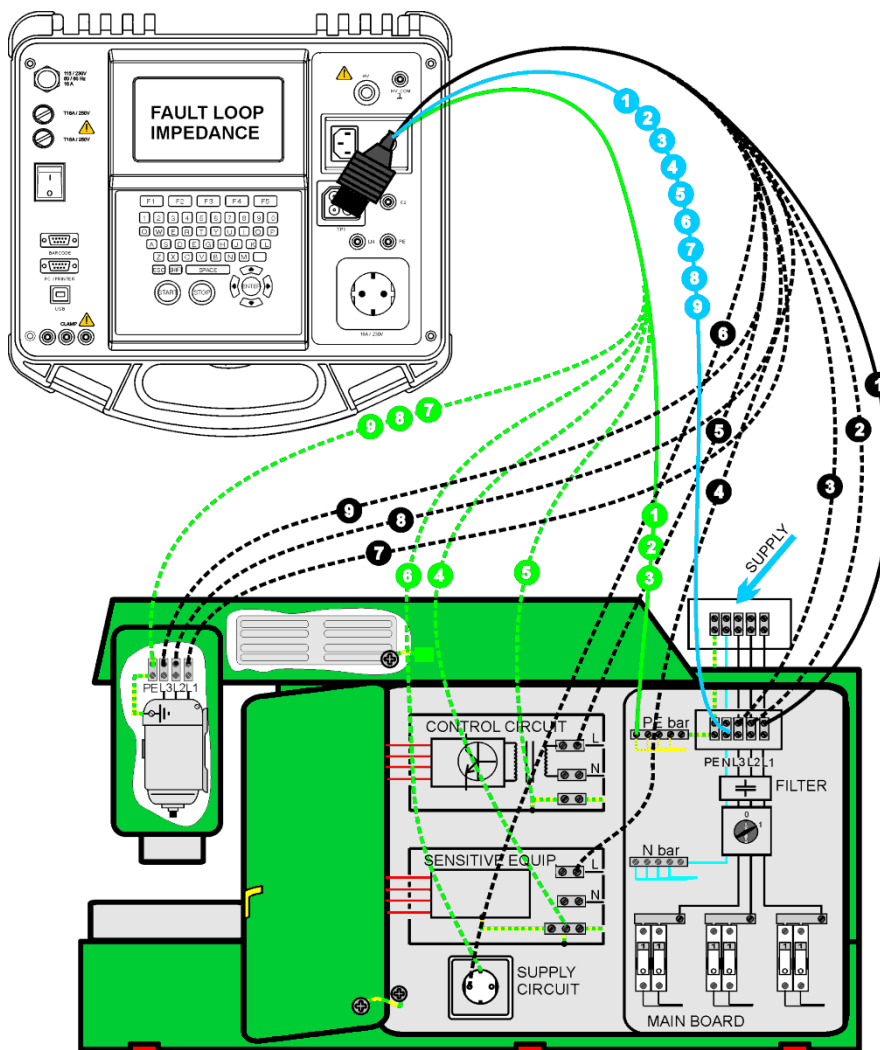

*Measurement of fault loop impedance*

**Fault loop impedance measurement procedure**

- Select the **Z LOOP** single test.
- Set test **parameters**.
- Connect** the three wire test lead to the TP1 port on the instrument.
- Connect** the three wire test lead to L, N and PE terminals of the machine.
- Press the **START** key for the measurement.
- Press **SAVE** (F4) for storing the result (optional).



Examples of fault loop impedance measurement results

Displayed results:

- Main result ..... Fault loop impedance,
- Isc ..... Prospective fault current,
- UI-pe ..... Voltage UL-PE
- Un-pe ..... Voltage UN-PE

$U_n$	Input voltage (L-PE)
110 V	$(93 V \leq U_{L-PE} < 134 V)$
230 V	$(185 V \leq U_{L-PE} \leq 266 V)$

**Notes:**

- The Z LOOP test may trip out the RCD in RCD-protected electrical installation.
- The fault loop impedance is measured between L and PE connection points of machine’s loads. Result is compared with *Ia* of belonging disconnection devices (fuses, breakers).



### 9.2.5.1 Z mΩL-Pe, High precision loop impedance measurement

The measurement is performed with Impedance adapter A1143. It is recognized in Z-LOOP function. With this adapter, low impedances from several mΩ up to 19.99 Ω can be measured. The measurement is covered by requirements of the EN 61557-3 standard.

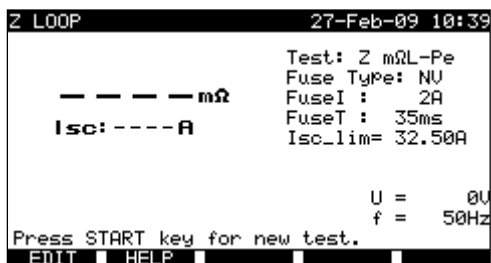

Impedance adapter connected

#### Test parameters for Z mΩL-Pe loop impedance measurement

Function Z mΩL-Pe (Z-LOOP)	
FUSE type	Selection of <b>fuse type</b> [*F, NV, gG, B, C, K, D] *
FUSE I	<b>Rated current</b> of selected fuse
FUSE T	Maximum <b>breaking time</b> of selected fuse
Isc_lim	Minimum short circuit <b>current</b> for selected fuse combination.

See *Appendix C* for reference fuse data.

\*F Means no fuse selected.

Additional key:

<b>F2</b>	Toggles between result screens.
-----------	---------------------------------

Test setup for Z mΩ-Pe fault loop impedance measurement

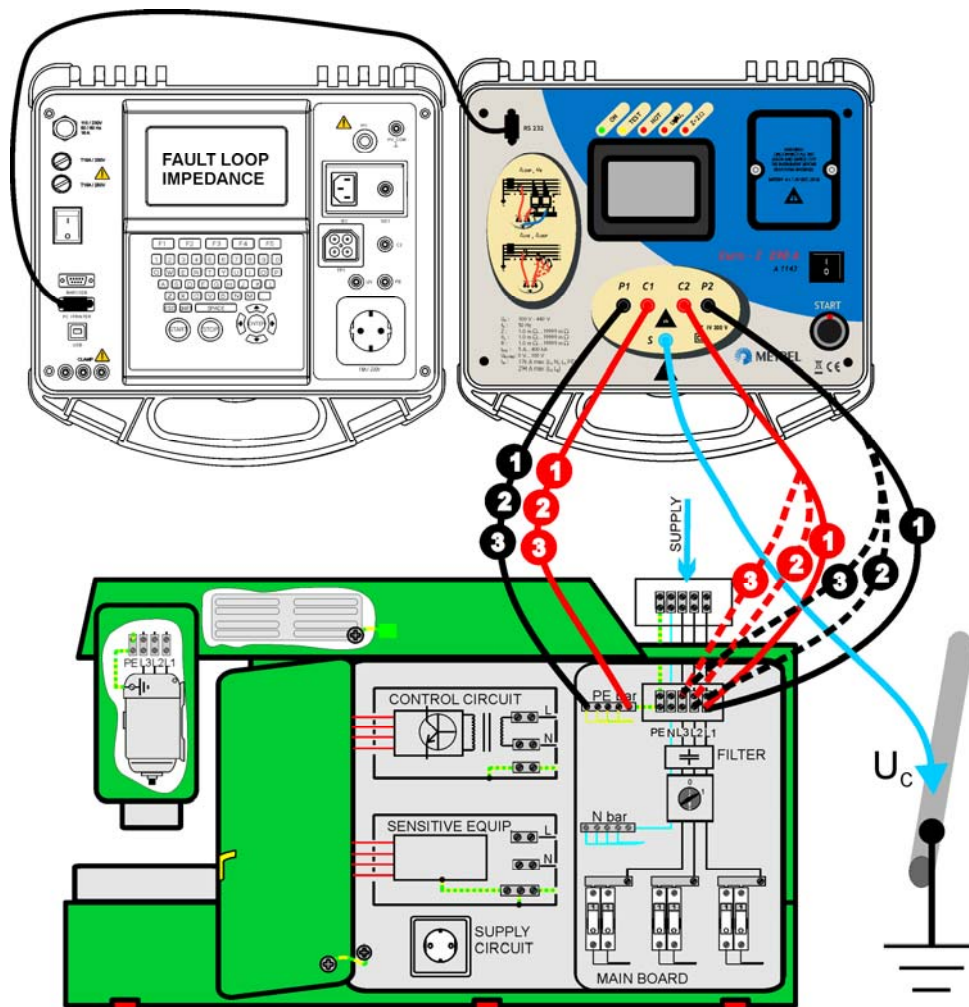

Connection of impedance adapter to the instrument

Z mΩ-Pe fault loop impedance measuring procedure

- ❑ **Connect** Impedance adapter to the instrument (see figure above).
- ❑ Select **Z-LOOP** function.
- ❑ Select **Z mΩ-Pe** test.
- ❑ Enable and set **limit** value.
- ❑ Power **ON** the Impedance adapter (ON/OFF key, green LED is lit).
- ❑ **Connect** Impedance adapter to tested machine installation.
- ❑ Press the **START** key for measurement.
- ❑ **Store** the result (optional).

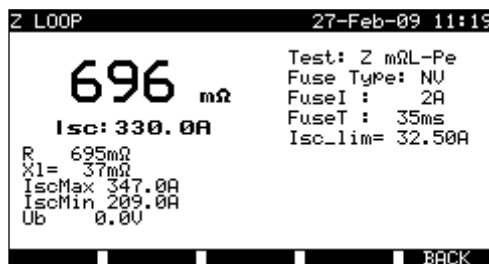

Example of Z mΩ-Pe loop measurement results

Displayed results:

- Z..... Loop impedance,
- Isc..... Prospective fault current,
- R..... Resistive part of line impedance,
- Xl..... Reactive part of line impedance.

The following parameters are displayed in sub-screen for loop impedance measurement:

- IscMaxL-Pe ..... Maximum prospective fault current.
- IscMinL-Pe ..... Minimum prospective fault current.
- IscStd ..... Standard prospective fault current.
- Ub..... Contact voltage at maximum prospective fault current (Contact voltage is measured against probe S terminal).

**Notes:**

- For application and technical data of the Impedance adapter A1143 see its user manual 20750859.
- High fluctuations of mains voltage can influence the measurement results.
- Check adapter indications in case the abort  symbol appears after the start of measurement.
- Pay attention on serial port settings.
- 

**9.2.6 RCD tests**

Various test and measurements are required for verification of RCD(s) in RCD protected machines. Measurements are complies to the EN 61557-6 standard.

The following measurements and tests (sub-functions) can be performed:

- Contact voltage,
- Trip-out time,
- Trip-out current,
- RCD autotest.

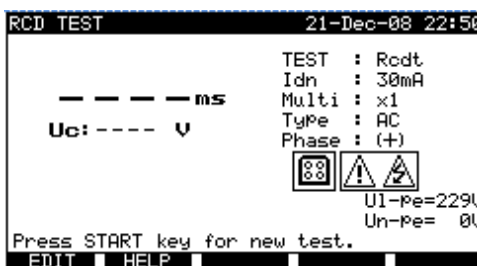

RCD test menu

**Test parameters for RCD test and measurement**

TEST	RCD <b>sub-function</b> test [Tripout time - RCDt, Uc, AUTO, Tripout current].
Idn	<b>Rated</b> RCD residual current sensitivity $I_{\Delta N}$ [10 mA, 30 mA, 100 mA, 300 mA, 500 mA, 1000 mA].
Multi	<b>Multiplier</b> of Idn [ $\frac{1}{2}$ , 1, 2, 5].
Type	RCD <b>type</b> [AC, A, B*, AC_S, A_S, B_S*]
Phase	Starting <b>phase</b> [(+), (-)].

The instrument is intended for testing of general (non-delayed) and **S**elective (time-delayed) RCDs, which are suited for:

- Alternating residual current (AC type),
- Pulsating residual current (A type).
- DC residual current (B type)\*

\* Instrument HW version 3.0 or higher

Time delayed RCDs have delayed response characteristics. The contact voltage pre-test can influence the trip out time of time delayed RCDs therefore a delay of 30 s is inserted before performing the trip-out test.

**Test circuit for RCD tests**

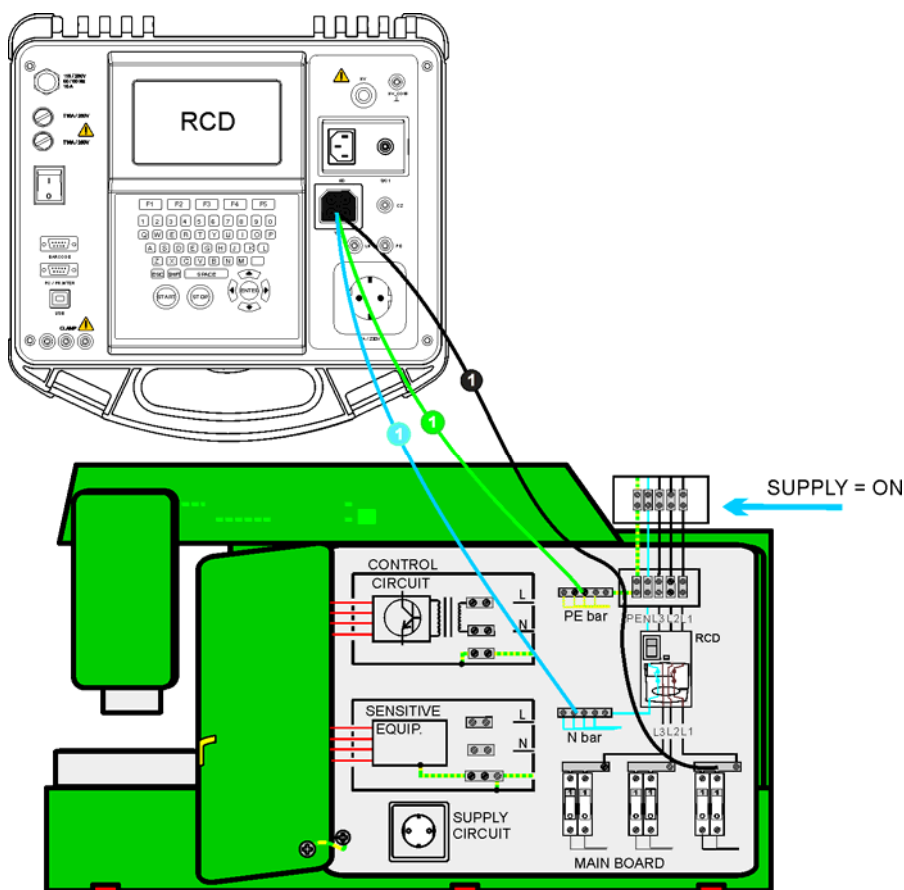

RCD tests (machine testing)

**9.2.6.1 Contact voltage (RCD Uc)**

The contact voltage test verifies that RCDs and earthing arrangement are effective. The contact voltage is measured with a test current lower than  $\frac{1}{2} I_{\Delta N}$  to avoid trip-out of the RCD and then normalized to the rated  $I_{\Delta N}$ .

**Contact voltage measurement procedure**

- Select the **RCD Uc** test.
- Set test **parameters**.
- Connect** three wire test lead to the TP1 test port on the instrument.
- Connect** the three wire test lead to L,N (downstream of the RCD) and PE terminals of the machine.
- Press the **START** key for the measurement.
- Press **SAVE** (F4) key for storing the result (optional).

The displayed contact voltage is proportional to the rated nominal residual current of the RCD and multiplied by appropriate factor. The 1.05 factor is applied to avoid negative tolerance of result. An additional factor depends on RCD type and type of test current. See table below for detailed contact voltage calculation.

RCD type		Contact voltage Uc proportional to	Rated I <sub>ΔN</sub>	
AC	G	1.05×I <sub>ΔN</sub>	any	all instrument versions
AC	S	2×1.05×I <sub>ΔN</sub>		
A	G	1.4×1.05×I <sub>ΔN</sub>	≥ 30 mA	
A	S	2×1.4×1.05×I <sub>ΔN</sub>	< 30 mA	
A	G	2×1.05×I <sub>ΔN</sub>		
A	S	2×2×1.05×I <sub>ΔN</sub>		
B	G	2×1.05×I <sub>ΔN</sub>	any	instrument HW version 3.0 and higher
B	S	2×2×1.05×I <sub>ΔN</sub>		

*Relationship between Uc and I<sub>ΔN</sub>*

Loop resistance result is indicative and calculated from Uc result (without additional proportional factors) according to following equation:

$$R_L = \frac{U_c}{I_{\Delta N}}$$



*Example of contact voltage measurement results*

Displayed results:

- Main result ..... Contact voltage.
- RI ..... Fault loop resistance.
- UI-pe ..... Voltage UL-PE
- Un-pe ..... Voltage UN-PE

### 9.2.6.2 Trip out time (RCD t)

Trip-out time measurement verifies the sensitivity of an RCD, at different test currents.

#### Trip out time measurement procedure

- Select the **RCD t** single test.
- Set test **parameters**.
- Connect** three wire test lead to the TP1 test port on the instrument.
- Connect** the three wire test lead to L,N (downstream of the RCD) and PE terminals of the machine.
- Press the **START** key for the measurement.
- Press **SAVE** (F4) key for storing the result (optional).



Example of RCD trip out time measurement results

Displayed results:

Main result ..... Trip-out time,  
 Uc ..... Contact voltage for rated  $I_{\Delta N}$ .

**Notes:**

- The RCD t test will trip the RCD. Assure that the instrument is not powered from a socket protected by the tested RCD.

### 9.2.6.3 Trip out current (RCD I)

A continuously rising residual current is intended for testing the threshold sensitivity for RCD trip-out. The instrument increases the test current in small steps through appropriate range as follows:

RCD type	Slope range		Waveform	Note
	Start value	End value		
AC	$0.2 \times I_{\Delta N}$	$1.1 \times I_{\Delta N}$	Sine	all instrument versions
A ( $I_{\Delta N} \geq 30 \text{ mA}$ )	$0.2 \times I_{\Delta N}$	$1.5 \times I_{\Delta N}$	Pulsed	
A ( $I_{\Delta N} = 10 \text{ mA}$ )	$0.2 \times I_{\Delta N}$	$2.2 \times I_{\Delta N}$		
B	$0.2 \times I_{\Delta N}$	$2.2 \times I_{\Delta N}$	DC	instrument HW version 3.0 and higher

Maximum test current is  $I_{\Delta}$  (trip-out current) or end value in case the RCD didn't trip-out.

**Trip out current measurement procedure**

- Select the **RCD I** single test.
- Set test **parameters**.
- Connect** three wire test lead to the TP1 test port on the instrument.
- Connect** the three wire test lead to L,N (downstream of the RCD) and PE terminals of the machine.
- Press the **START** key for the measurement.
- Press **SAVE** (F4) key for storing the result (optional).



*Examples of RCD trip out current measurement results*

Displayed results:

- Main result ..... Trip-out current,
- t..... Trip out time at  $I\Delta$
- Uci ..... Contact voltage at trip-out current  $I\Delta$ , or end value in case the RCD didn't trip.
- Ul-pe ..... Voltage UL-PE
- Un-pe..... Voltage UN-PE

**Note:**

- The RCD I test will trip the RCD. Assure that the instrument is not powered from a socket protected by the tested RCD.

**9.2.6.4 RCD Autotest**

RCD autotest function is intended to perform a complete RCD test and measurement of all safety parameters (contact voltage, fault loop resistance and trip-out time at different residual currents) in one set of automatic tests, guided by the instrument.

**RCD autotest procedure**

RCD Autotest steps	Notes
<ul style="list-style-type: none"> <li><input type="checkbox"/> Select the RCD single test.</li> <li><input type="checkbox"/> Set <b>RCD AUTO</b> test.</li> <li><input type="checkbox"/> Set test <b>parameters</b>.</li> <li><input type="checkbox"/> <b>Connect</b> three wire test lead to the TP1 test port on the instrument.</li> <li><input type="checkbox"/> <b>Connect</b> the three wire test lead to L, N (downstream of the RCD) and PE terminals of the machine.</li> <li><input type="checkbox"/> Press the START key.</li> </ul>	Start of test
<ul style="list-style-type: none"> <li><input type="checkbox"/> Test with <math>I\Delta N</math>, (+) (step 1).</li> </ul>	RCD should trip-out
<ul style="list-style-type: none"> <li><input type="checkbox"/> <b>Re-activate</b> RCD.</li> </ul>	

<input type="checkbox"/> Test with $I\Delta N$ , (-) (step 2).	RCD should trip-out
<input type="checkbox"/> <b>Re-activate</b> RCD.	
<input type="checkbox"/> Test with $5\times I\Delta N$ , (+) (step 3).	RCD should trip-out
<input type="checkbox"/> <b>Re-activate</b> RCD.	
<input type="checkbox"/> Test with $5\times I\Delta N$ , (-) (step 4).	RCD should trip-out
<input type="checkbox"/> Test with $\frac{1}{2}\times I\Delta N$ , (+) (step 5).	RCD should not trip-out
<input type="checkbox"/> Test with $\frac{1}{2}\times I\Delta N$ , (-) (step 6).	RCD should not trip-out End of test
<input type="checkbox"/> Press <b>SAVE</b> (F4) key for storing the result (optional).	

Result examples:

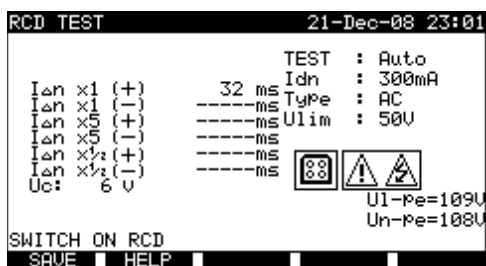

Step 1

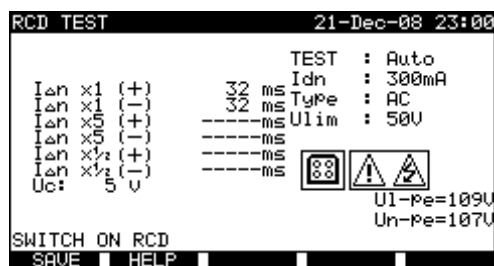

Step 2

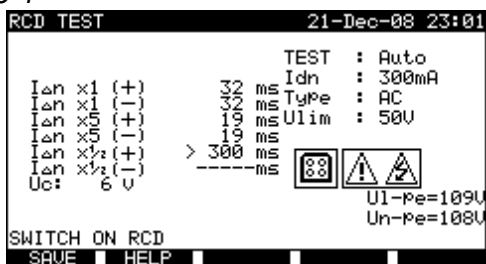

Step 3

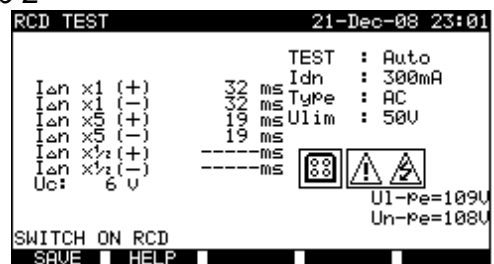

Step 4

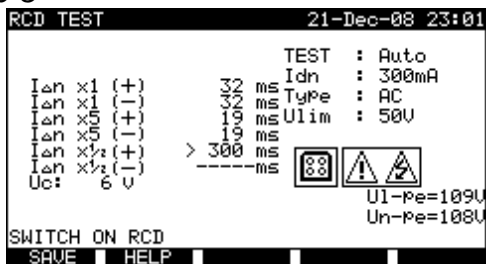

Step 5

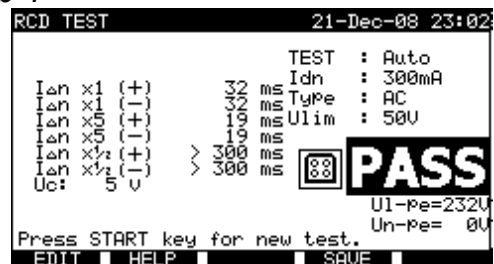

Step 6

Individual steps in RCD autotest

Displayed results:

- $I\Delta N$  x1 (+)..... Step 1 trip-out time ( $I\Delta N$ , (+)),
- $I\Delta N$  x1 (-) ..... Step 2 trip-out time ( $I\Delta N$ , (-)),
- $I\Delta N$  x5 (+)..... Step 3 trip-out time ( $5\times I\Delta N$ , (+)),
- $I\Delta N$  x5 (-) ..... Step 4 trip-out time ( $5\times I\Delta N$ , (-)),
- $I\Delta N$  x $\frac{1}{2}$  (+)..... Step 5 trip-out time ( $\frac{1}{2}\times I\Delta N$ , (+)),
- $I\Delta N$  x $\frac{1}{2}$  (-) ..... Step 6 trip-out time ( $\frac{1}{2}\times I\Delta N$ , (-)),
- Uc ..... Contact voltage for rated  $I\Delta N$ .
- U1-pe ..... Voltage UL-PE
- Un-pe ..... Voltage UN-PE



**Notes:**

- The autotest sequence is immediately stopped if any incorrect condition is detected, e.g. excessive  $U_c$  or trip-out time out of limits.
- The RCD t test will trip the RCD. Assure that the instrument is not powered from a socket protected by the tested RCD.

**9.2.7 PRCD test**

Description in chapter 6.2.10 *PRCD test* can be used as reference.

**9.2.8 Discharging Time**

If large capacitors in machines are disconnected from supply there is often a remaining (residual) charge on internal machine components. Live parts having a residual voltage greater than 60 V shall be discharged to 60 V or less within a time period of 5 s after disconnection of the supply.

For plugs or similar devices with exposed conductors (for example pins) if plugged out the discharge time shall be discharged to 60 V or less within a time period of 1 s after disconnection of the supply.

**Measuring principle**

The test leads are connected to terminals where residual voltage is to be measured. The machine is switched ON, the voltage on terminals can be of a.c. or d.c. type.

**Phase 1:** The instrument monitors the voltage and internally stores the peak voltage value.

**Phase 2:** The machine is disconnected from the power supply and the voltage at the test terminals starts to fall. Once the voltage falls for 10V the instrument starts the timer.

**Phase 3:** After the voltage drops below an internally calculated voltage value the timer is stopped. The instrument recalculates the measured time to a value as it would be if the disconnection occurred at the maximum voltage value.

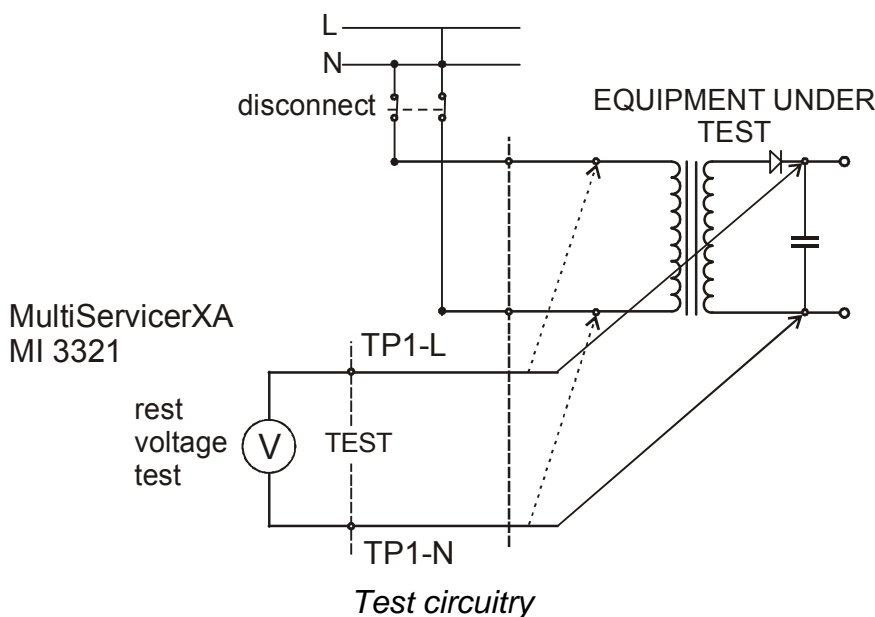

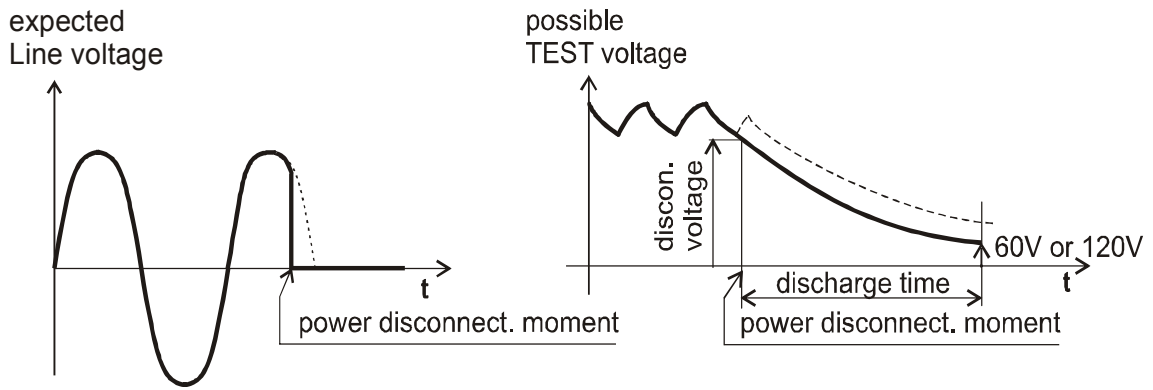

Measured voltage

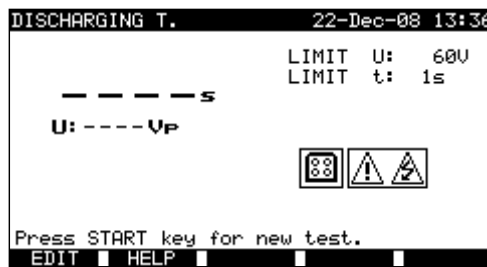

Discharging time menu

**Test parameters for Discharging Time**

Limit U	<b>Rated</b> maximal residual voltage. [60 V].
Limit t	<b>Rated</b> maximal discharging time [1 s, 5 s].

## Test circuit for Discharging Time test

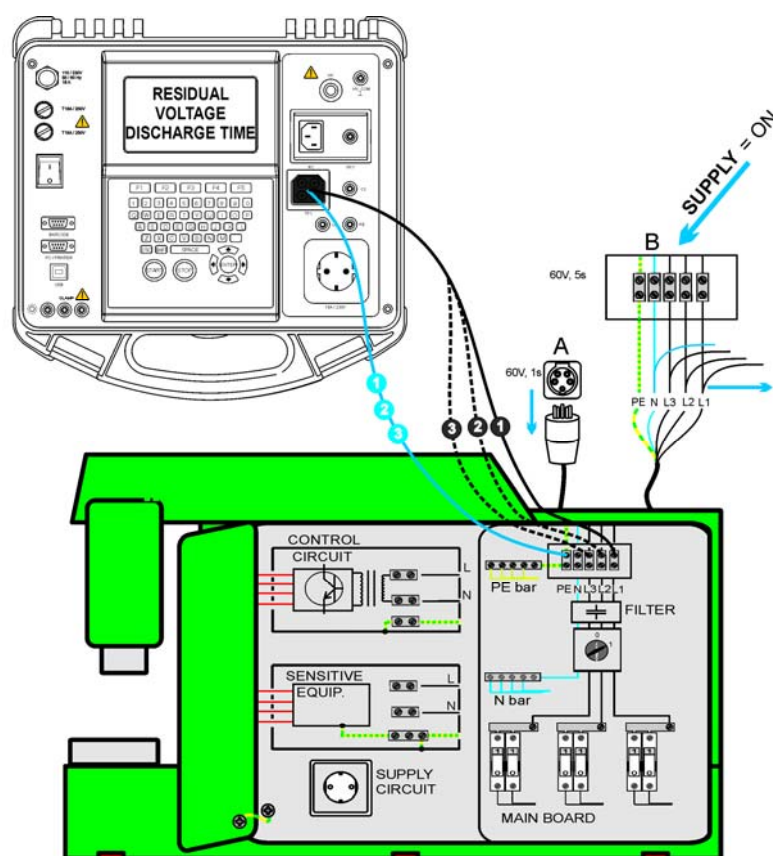

Discharging time test

## Trip out current measurement procedure

- Select the **Discharging Time** single test.
- Set test **parameters**.
- Connect** three wire test cable to the TP1 test port on the instrument.
- Connect** L and N wires of the three wire test cable to terminals to be tested.
- Press the **START** key to start the measurement.
- Wait** until "Ready" is displayed
- Disconnect** the machine. "Wait" is displayed until the residual voltage drops below 60V. If the voltage at disconnection moment is too low to get an accurate result "Repeat" is displayed. The measurement must be repeated
- Press **SAVE** (F4) key for storing the result (optional).

## Interpretation of the "Repeat" message

It is not possible to differentiate between a disconnection moment at very low voltage and a machine with a very low discharging time. In both cases the reading will be 0.0 s together with the "Repeat" warning. If after few repetitions the result is always 0.0 s with the "Repeat" message it can be considered as a valid 0.0 s result..  
A 0.0 s reading without the "Repeat" message is a valid result.



The 0.0 s and Repeat message



Examples of discharging time measurement results

Displayed results:

Main result ..... Discharging time,  
U ..... Peak voltage value

**Note:**

- Consider any displayed warning before starting the test!

**9.2.9 Voltage**

Voltages and their frequency are measured in this menu. If a three-phase rotary field is detected its direction is displayed. The phase sequence measurement conforms to the EN 61557-7 standard.

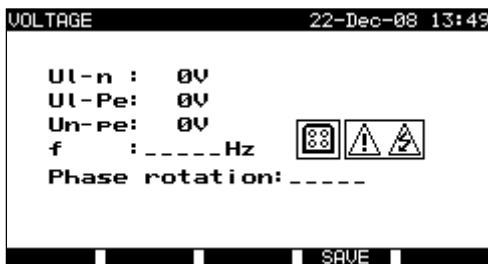

Voltage menu

**Test parameters for Voltage single test**

There are no parameters to be set in this function.

## Test circuit for Voltage test

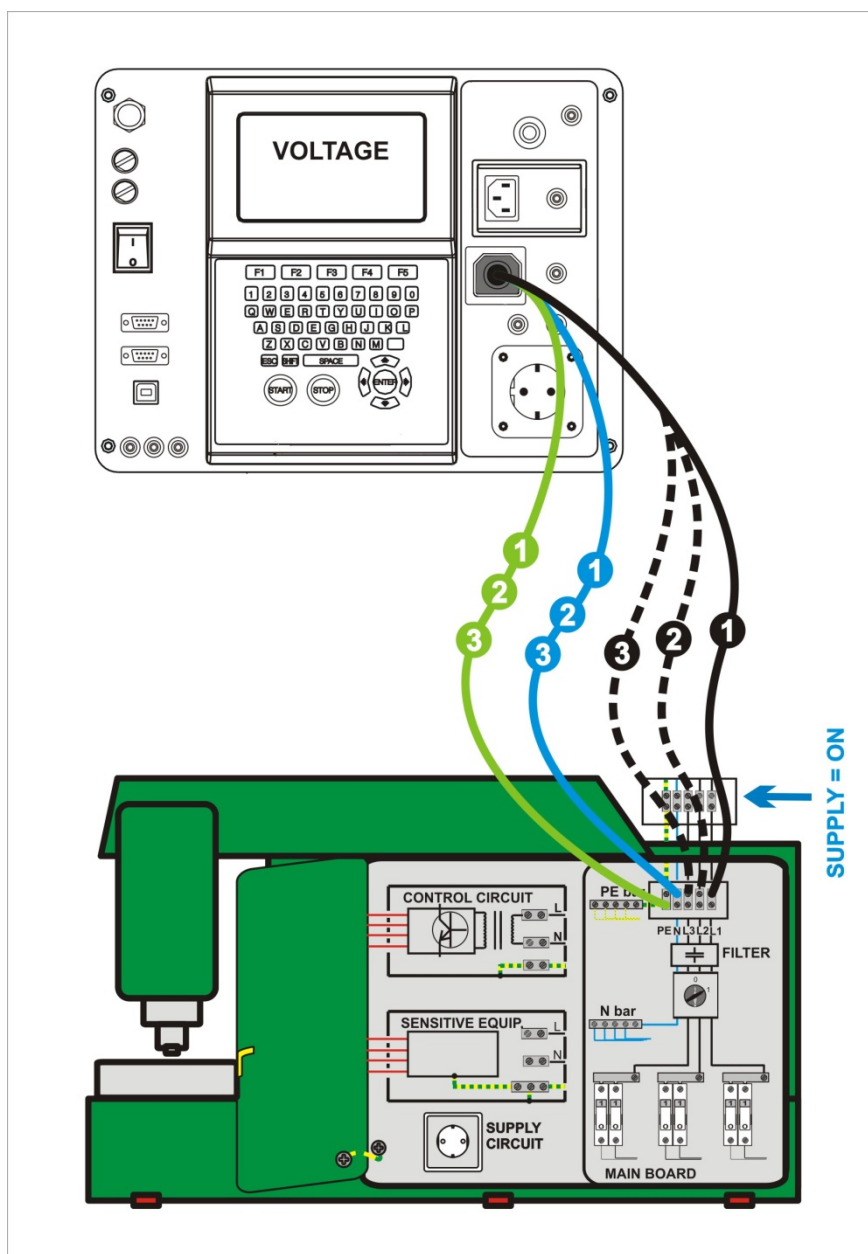

Voltage test

### Voltage and rotary filed measurement procedure

- Select the **Voltage** single test.
- The measurement starts immediately after entering in the Voltage menu.
- Connect** three wire test cable to the TP1 test port on the instrument.
- Connect** L and N and PE wires of the three wire test cable to terminals to be tested (L, N, PE for single phase and L1, L2, L3 for three phase systems)
- Press **SAVE** (F4) key for storing the result (optional).

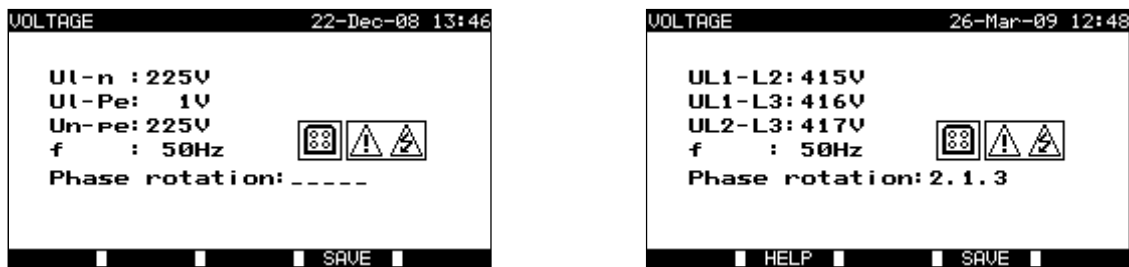

Examples of voltage measurement results

Displayed results for single phase system:

UI-n ..... Voltage between phase and neutral conductors,  
 UI-pe ..... Voltage between phase and protective conductors,  
 Un-pe ..... Voltage between neutral and protective conductors,  
 f ..... frequency.

Displayed results for three-phase system:

UL1-L2 ..... Voltage between phases L1 and L2,  
 UL1-L3 ..... Voltage between phases L1 and L3,  
 UL2-L3 ..... Voltage between phases L2 and L3,  
 1.2.3 ..... Correct connection – CW rotation sequence,  
 2.1.3 ..... Invalid connection – CCW rotation sequence,  
 f ..... frequency.

**Note:**

- Consider any displayed warning before starting test!

### 9.2.10 Functional test

In its simplest form a functional check is simply a check to ensure that the machine is working properly.

#### Scope of test

Check following items while the machine is operating:

- Temperature regulators, monitors,
- RCDs and other disconnection devices,
- Operation of functional disconnecting devices,
- Operation of switches, lamps, keys,
- Rotating parts, motors, pumps,
- Power consumption,
- Etc.

Especially safety relevant functions should be checked..

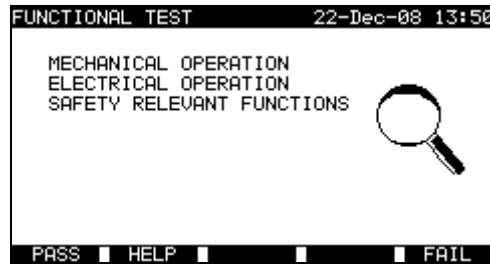

*Functional test menu*

### Functional test procedure

- Select the **Functional test** function.
- Perform **visual inspection** of the machine functionality.
- Commit **PASS** (F1) or **FAIL** (F5) ticker manually.
- Save result with **SAVE** (F4) key (optional).

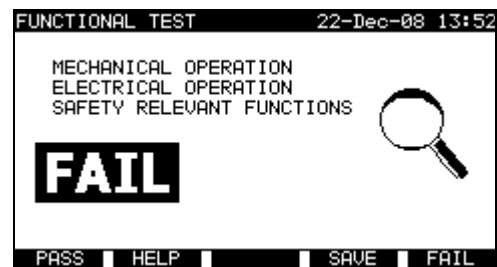
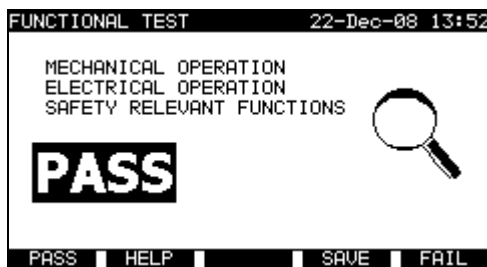

*Examples of functional test results*

## 10 Switchgear testing operating mode

The Switchgear testing operating mode is primarily intended for testing of electrical safety of switchgear according to the standard IEC/ EN 60439.

After entering the **Switchgear testing menu** following options are displayed:

Single test menu (see 10.1),  
Memory operations (see 12.1)



Main menu

Keys:

▼ / ▲	Select the operating mode.
<b>ENTER</b>	Enters selected mode.

**Note:**

- Press ESC key one or more times to return to Switchgear testing main menu testing from any submenu

### 10.1 Single tests (switchgear testing) menu

The measurements and their parameters in this menu are suited for verification of switchgears.

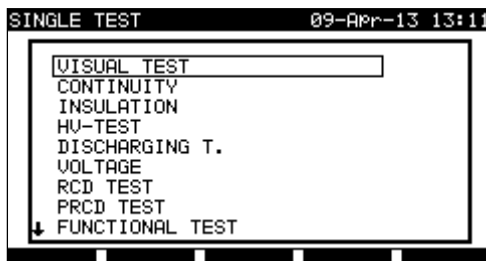

Single test menu

Keys:

▼ / ▲	Select the test / measuring function: <Visual test>, Visual inspections. <Continuity>, Continuity of protective conductors tests. <Insulation>, Insulation resistance. <HV-test>, High Voltage tests. <Discharging time>, Discharging time tests. <Voltage>, Voltage, frequency and rotary field tests. <RCD test>, Tests of residual current devices.
-------	---



	< <b>PRCD test</b> > Tests of portable residual current devices, < <b>Functional test</b> >, Functional inspection. < <b>Power</b> >, Power consumption test.
<b>ENTER</b>	Enters selected test.
<b>ESC</b>	Returns to Main menu.

**Note:**

- Unlike in PAT testing mode all single test results and parameters can be stored for documentation purposes (see chapter 12.1 for more information).

**10.2 Measurements and inspections****10.2.1 Visual test**

Visual check is the most important and effective part of a switchgear test.

Electrical testing often does not disclose failures that become apparent on visual inspection. A visual check must be carried out before each electrical safety test.

Following items should be checked:

- Wiring connection points,
- Protection covers, housings,
- Inscriptions and markings especially that related to safety,
- Cables (layout, radiuses, isolation),
- Switches, regulators, lamps, keys,
- Electrical and mechanical protection devices (barriers, switches, fuses, alarms),
- Technical documentation.

During visual inspection the measuring points for the electrical testing have to be determined too.

Check that there are no signs of:

- Damage,
- Pollution, moisture, dirt that can jeopardize safety,
- Corrosion,
- Overheating.

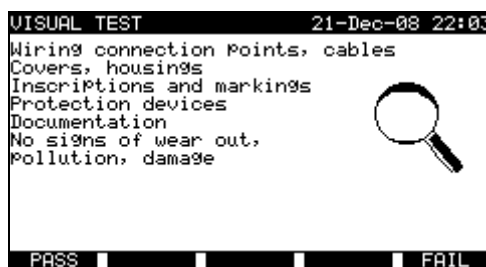

*Visual test menu*

**Visual test procedure**

- Select the **VISUAL TEST** function.
- Perform **visual inspection** of the machine.
- Commit **PASS** or **FAIL** ticker manually (with PASS(F1), FAIL(F5) keys).
- Save result (optionally) with **SAVE** key



Examples of visual test measurement results

### 10.2.2 Continuity

This test determines that the PE and equipotential connections inside the switchboard have a proper resistance that corresponds to their length and cross-section.

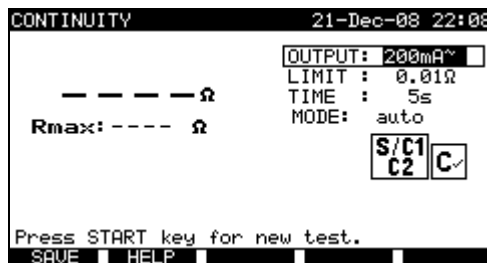
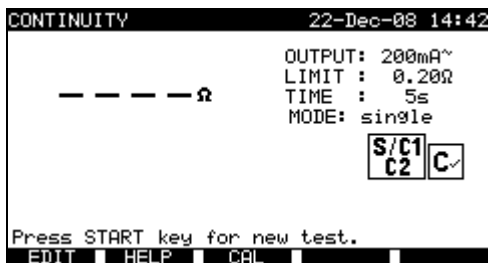

Continuity menus

#### Test parameters for Continuity measurement

OUTPUT	Test current [200 mA, 10 A]
LIMIT	Maximum resistance [0.01 Ω ÷ 0.09 Ω, 0.10 Ω ÷ 0.90 Ω, 1.00 Ω ÷ 9.00 Ω]
TIME	Measuring time [5 s, 10 s, 30 s, 60 s, 120 s, 180 s]
MODE	Operation mode [single, auto]

## Test circuit for Continuity measurement

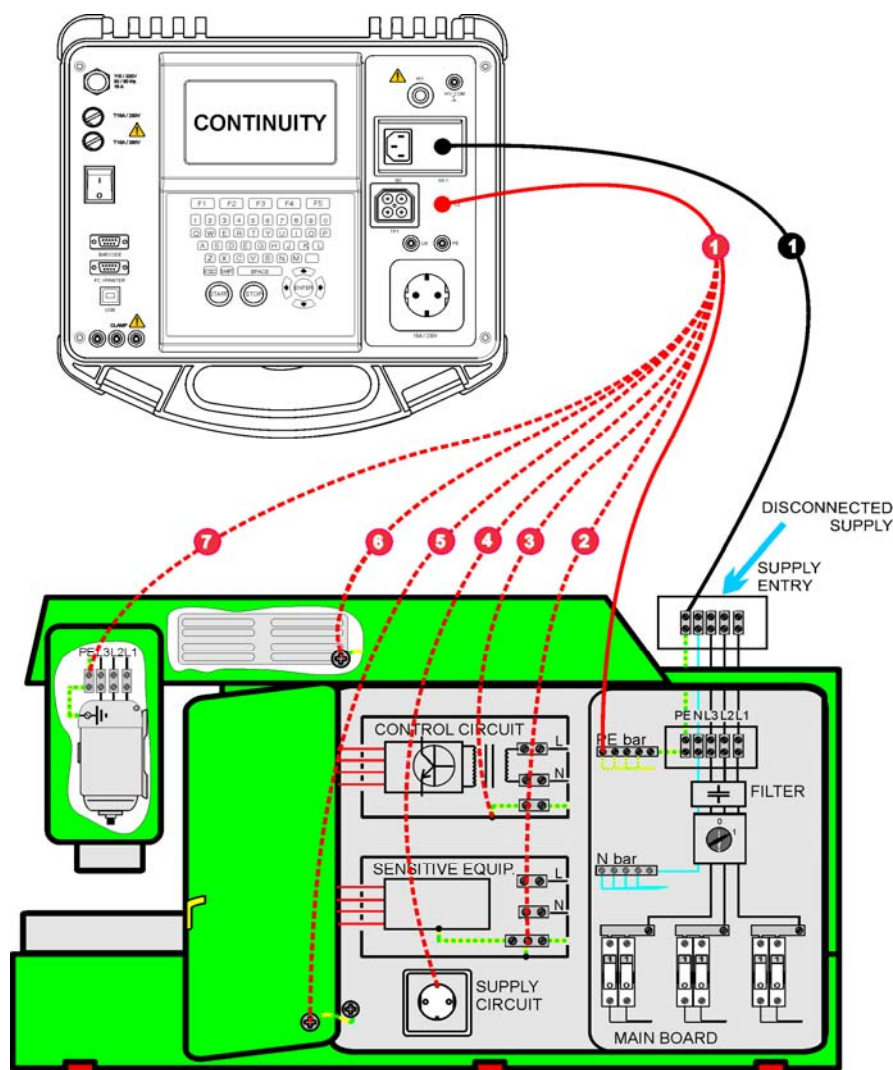

*Measurement of continuity of protective conductors of switchboards*

### 10.2.2.1 Single continuity test

In the single continuity test the continuity of individual connections can be determined.

#### Continuity measurement procedure

- Select the **CONTINUITY** function.
- Set test **parameters**
- Make sure that the test leads are calibrated. Calibrate them if necessary (See chapter 10.2.2.3 Compensation of test leads resistance for more information).
- Connect** test leads to S/C1 and C2 terminals on the instrument.
- Connect** test leads to both ends of protective conductor under test.
- Press the **START** key for measurement.
- Press **SAVE** (F4) key for storing the result (optional).

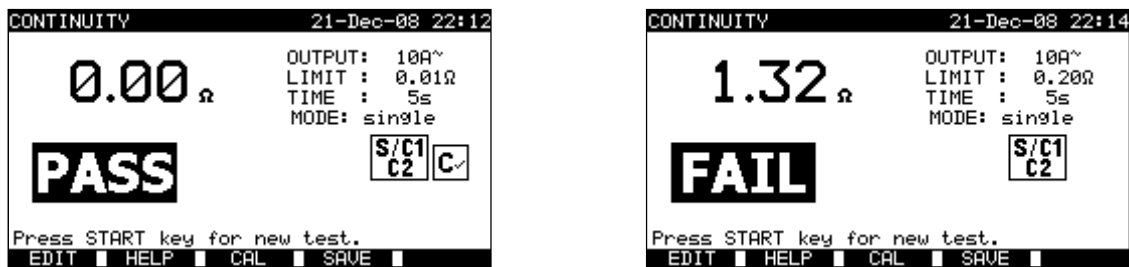

Examples of continuity measurement results

Displayed results:

Main result ..... Continuity

#### Notes:

- Consider displayed warnings before starting measurement!
- For more information how to calibrate the test leads see chapter xy.

#### 10.2.2.2 Auto-continuity test

In the auto continuity test mode up to 30 continuity tests can be performed and stored in one step. Additional features are:

- Connection of test leads to a low resistance connections is detected and the measurements starts/ stops automatically,
- Sound warnings are indicating the actual phase of the measurement.
- The autotest is useful if testing large switchboards with a lot of PE connection points.
- The user does not need to return to the instrument and pressing START/STOP/SAVE keys for each individual measurement. The test can easily be carried out by one person even if testing with long test leads on large switchboards.

#### Continuity measurement procedure

- Select the **CONTINUITY** function.
- Set test **parameters**.
- Make sure that the test leads are calibrated. Calibrate them if necessary (See chapter 10.2.2.3 Compensation of test leads resistance for more information).
- Connect** test leads to S/C1 and C2 terminals on the instrument.
- Press the **START** key for measurement. The instrument is monitoring for a low resistance between the test leads is detected.
- Connect** test leads to both ends of the first PE connection under test. The instrument detects (double beep) the low resistance and starts first measurement.
- After the timer elapse the instruments temporarily stores the first result. A sound signal (short beeps) indicates that the first measurement is concluded and temporarily stored. The results displayed in this phase will not be stored.
- Disconnect** test leads and proceed to the next measuring point (no beep).
- Connect** test leads to both ends of the second PE connection under test. The instrument detects (double beep) the low resistance and starts second measurement.
- After the timer elapse the instruments temporarily stores the second result. A sound signal (continuous short beeps) indicates that the second measurement is concluded

- and temporarily stored. The results displayed in this phase will not be stored.
- Disconnect** test leads and proceed to the next measuring point. **(no beep)**
- Connect** test leads to both ends of tested PE. The instrument detects (double beep) the low resistance and starts last measurement.
- After the timer elapse the instruments temporarily stores the last result. A sound signal (short beeps) indicates that the last measurement is concluded and temporarily stored. The results displayed in this phase will not be stored.
- Disconnect** test leads (no beep).
- Press **STOP** key to stop the measurement.
- Press **SAVE** (F4) key for storing the result (optional). All temporarily stored results are saved into the instruments memory.

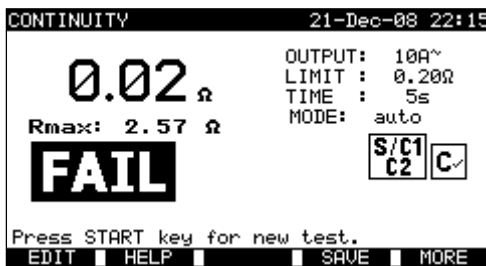

Example of continuity measurement results – normal view

Displayed results:

Main result ..... actual measured resistance / last measurement result  
 Rmax ..... highest measured resistance

By pressing the MORE (F5) key all measured results can be seen.

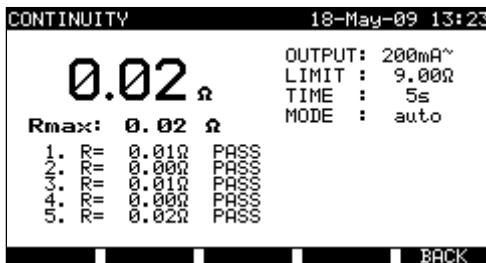

Examples of continuity resistance measurement results – all results view

Displayed results:

Main result .....actual measured resistance  
 Rmax .....highest measured resistance  
 Sub-results (1., 2., ...n) .....temporarily stored individual results

By pressing the BACK (F5) the instrument returns to normal view.

**Notes:**

- Consider displayed warnings before starting measurement!
- STOP key can be pressed anytime during the measurement. All concluded measurements are internally stored and can be saved to the instrument’s memory.

### 10.2.2.3 Compensation of test leads resistance

Test leads compensation is required to eliminate the influence of test leads resistance and instrument's internal resistance. If a compensation value is stored this is indicated in the message. Refer to chapter 9.2.2.3 *Compensation of test resistance* for more information.

### 10.2.3 Insulation resistance

Insulation resistance between live conductors and accessible (earthed or isolated) metal parts is checked. This test discloses faults caused by pollution, moisture, deterioration of insulation metal etc.

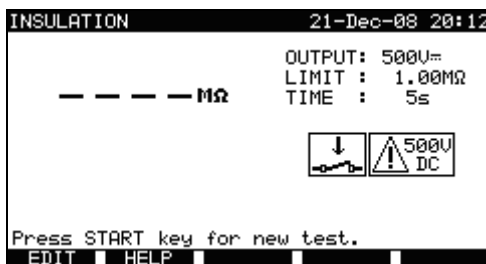

*Insulation resistance menu*

Test parameters for insulation resistance measurement

OUTPUT	<b>Test voltage</b> [250 V, 500 V]
LIMIT (Insulation)	<b>Minimum resistance</b> [0.10 MΩ, 0.30 MΩ, 0.50 MΩ, 1.00 MΩ, 2.00 MΩ, 4.00MΩ, 7.00 MΩ, 10.00 MΩ, none]
TIME	<b>Measuring time</b> [5 s, 10 s, 30 s, 60 s, 120 s, none]

## Test circuits for insulation resistance measurement

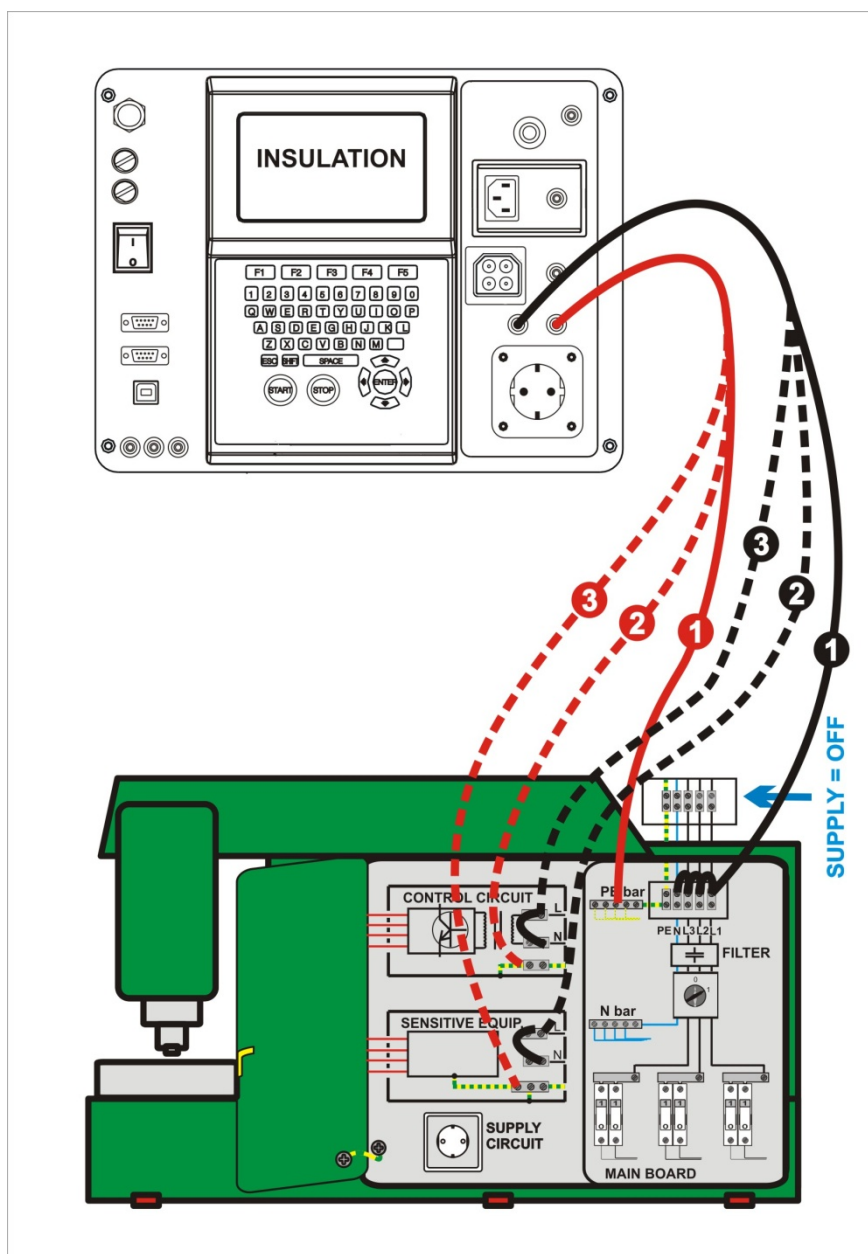

*Measurement of insulation resistance*

### Insulation resistance measurement

- Select the **Insulation** single test.
- Set test **parameters**.
- Connect** test leads to LN and PE terminals on the instrument.
- Connect** the LN test lead to the (temporarily connected) L and N terminals of the switchboard.
- Connect** the PE test lead to a PE terminal of the switchboard.
- Press the **START** key for the measurement.
- Press **SAVE** (F4) key for storing the result (optional).

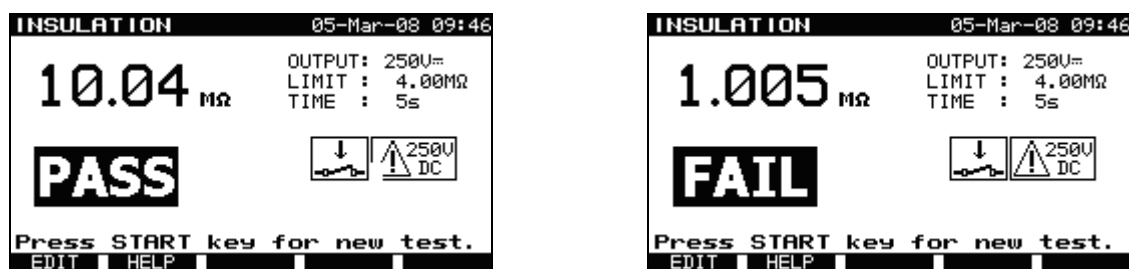

*Examples of insulation resistance measurement results*

#### Notes:

- The switchboard under test should be de-energized before the measurement!
- Consider any warning on the display before starting the measurement!
- Care must be taken if switchboard includes sensitive electrical equipment that could be damaged if too high test voltage would be applied to them.
- In this case the sensitive part should be disconnected from the tested circuitry. Depending on the product standard, they should be tested with an appropriately lower test voltage.
- If surge protection devices are installed the test can be carried out only in a limited manner.
- Do not disconnect the switchboard under test from the instrument during the measurement or before it is automatically discharged! The message »Discharging...« is displayed while the voltage on DUT is higher than 20 V!
- Do not forget to remove the L-N link(s) after the tests!**

### 10.2.4 High Voltage withstanding test

The High Voltage withstanding test is used to confirm integrity of the insulation materials. During the test the insulation materials in the switchboard are stressed with a higher voltage than during normal operation. A powerful AC high voltage source is applied between the live/ neutral input terminals and the metal housing of the switchboard; the instrument trips out if the leakage current exceeds the predefined limit.

#### **⚠ IMPORTANT SAFETY NOTES**

- As dangerous voltage of over 2500 V AC is applied at the HV instrument outputs special safety consideration must be taken when performing this test!**
- Disconnect all unused test leads before starting this measurement; otherwise the instrument can be damaged!**
- Only a skilled person familiar with hazardous voltages can perform this measurement!**
- DO NOT perform this test if any damage or abnormality (test leads, instrument) is noted!**
- Never touch exposed probe tip, connections equipment under test or any other energized part during the measurements. Make sure that NOBODY can contact them either!**
- Connect test probes only for the High Voltage test and disconnect them immediately after the test!**
- DO NOT touch any part of test probe in front of the barrier (keep your fingers behind the finger guards on the probe) – possible danger of electric shock!**



- Always use lowest possible trip-out current.

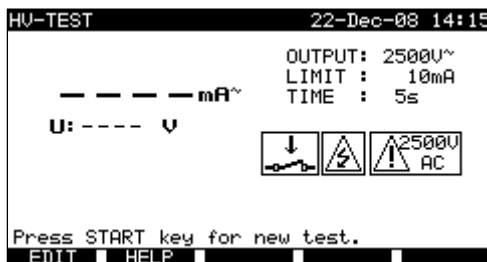

High Voltage menu (switchboard testing)

Test parameters for high voltage withstanding test

OUTPUT	Test voltage [1000 V, 1890 V, 2500 V]
LIMIT	Trip out current [2 mA, 5 mA, 10 mA, 20 mA, 50 mA, 100 mA]
TIME	Measuring time [2 s, 3 s, 5 s, 10 s, 30 s]

Test circuit for high voltage withstanding test

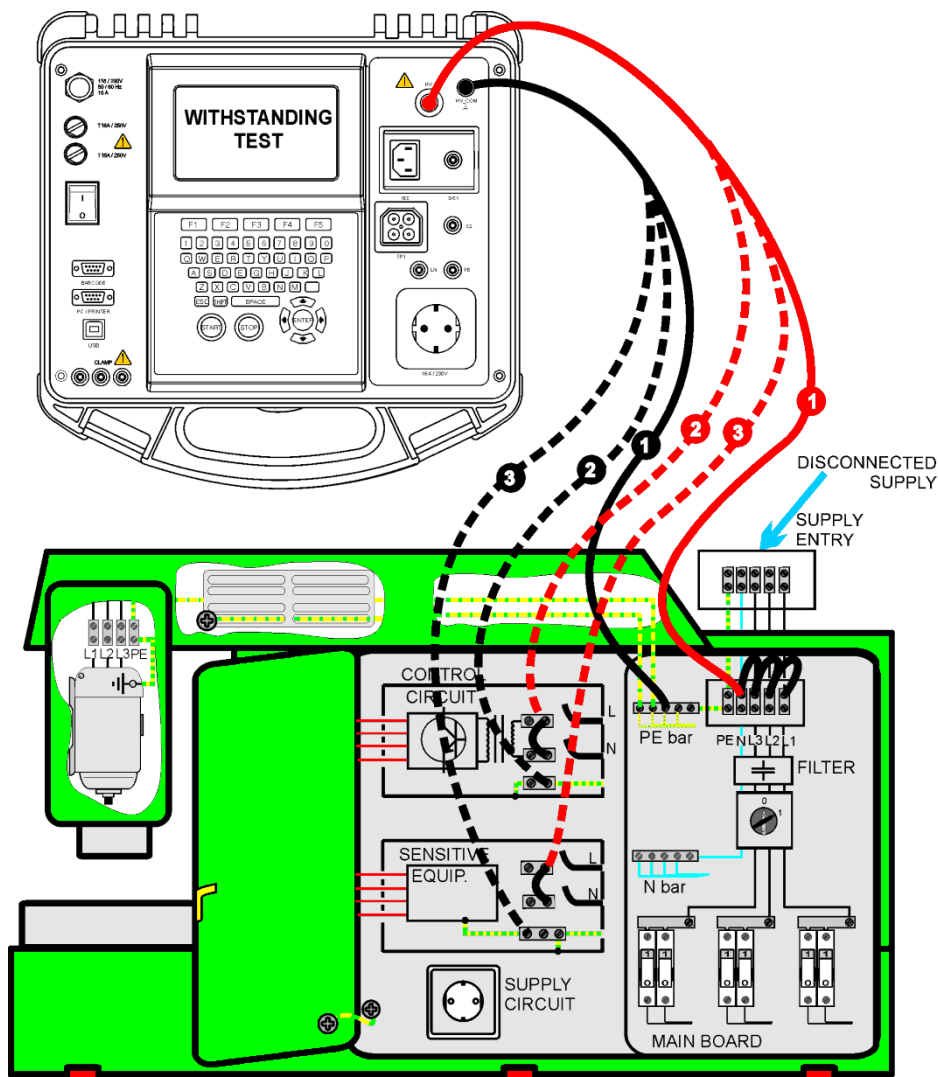

High voltage withstanding test

## High voltage withstanding test

- Select the **HV-TEST** single test.
- Set test **parameters**.
- Connect** test leads to HV and HV\_PE terminals on the instrument.
- Connect** the HV test lead to the L and N terminals of the switchboard (L and N terminals should be temporarily connected).
- Connect** the PE test lead to a PE terminal of the switchboard.
- Press and **hold** the **START** key for the measurement.
- If the test current exceeds the set trip out current the measurement is stopped immediately.
- The measurement is stopped immediately after the **START** key is **released**.
- Press **SAVE** (F4) key for storing the result (optional)

## Instructions for using the test probe

- Push the button on the probe to unlock the sleeve and touch tested object with test tip (keep the button pushed while the sleeve is not retracted upon few mm at least, than release it and retrieve the thumb behind the barrier).
- After the measurement retract the test tip from tested object and sleeve comes automatically over the tip.
- The sleeve locks itself automatically when it fully recovers the tip.



*Examples of high voltage withstanding test results*

### Notes:

- The switchboard should be de-energized before the measurement!
- Components and devices that are not rated to withstand the test voltage shall be disconnected during the testing.
- Components and devices that have been voltage tested in accordance with their product standards may be disconnected during testing.
- Consider any warning on the display before starting the measurement!
- If HV\_PE test probe is not connected, the test will not be started or will be interrupted. A "Test lead disconnected" warning is displayed.
- Do not forget to remove the L-N link after the tests.

### 10.2.5 Discharging Time

If large capacitors in switchboards are disconnected from supply there is often a remaining (residual) charge on internal switchboard components. Live parts having a residual voltage greater than 120 V shall be discharged to 120 V or less within a time period of 5 s after disconnection of the supply.

#### Measuring principle

The test leads are connected to terminals where residual voltage is to be measured. The switchboard is switched ON, the voltage on terminals can be of a.c. or d.c. type.

**Phase 1:** The instrument monitors the voltage and internally stores the peak voltage value.

**Phase 2:** The switchboard is disconnected from the power supply and the voltage at the test terminals starts to fall. Once the voltage falls for 10V the instrument starts the timer.

**Phase 3:** After the voltage drops below an internally calculated voltage value the timer is stopped. The instrument recalculates the measured time to a value as it would be if the disconnection occurred at the maximum voltage value.

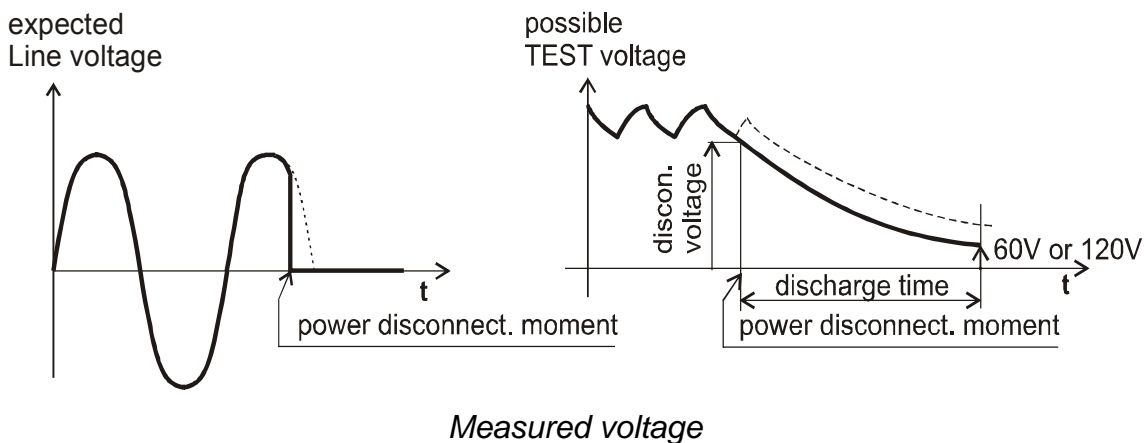
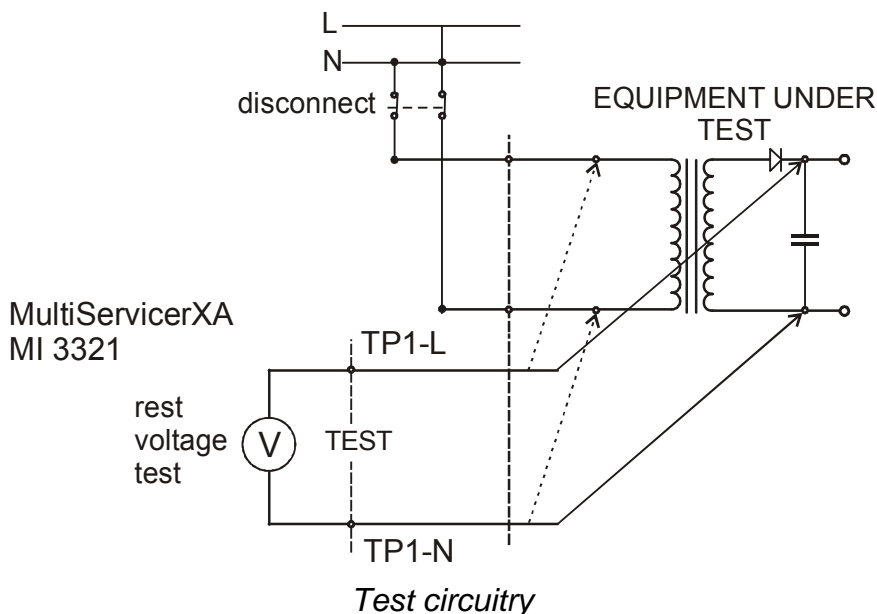

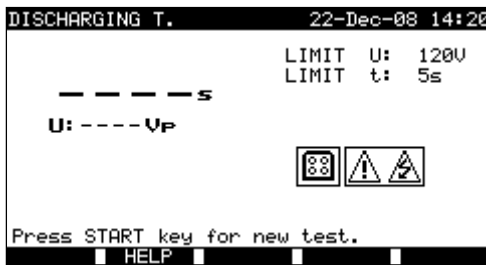

Discharging time menu

Test parameters for Discharging Time

Limit U	<b>Rated</b> maximal residual voltage [120 V].
Limit t	<b>Rated</b> maximal discharging time [5 s].

Test circuit for Discharging Time test

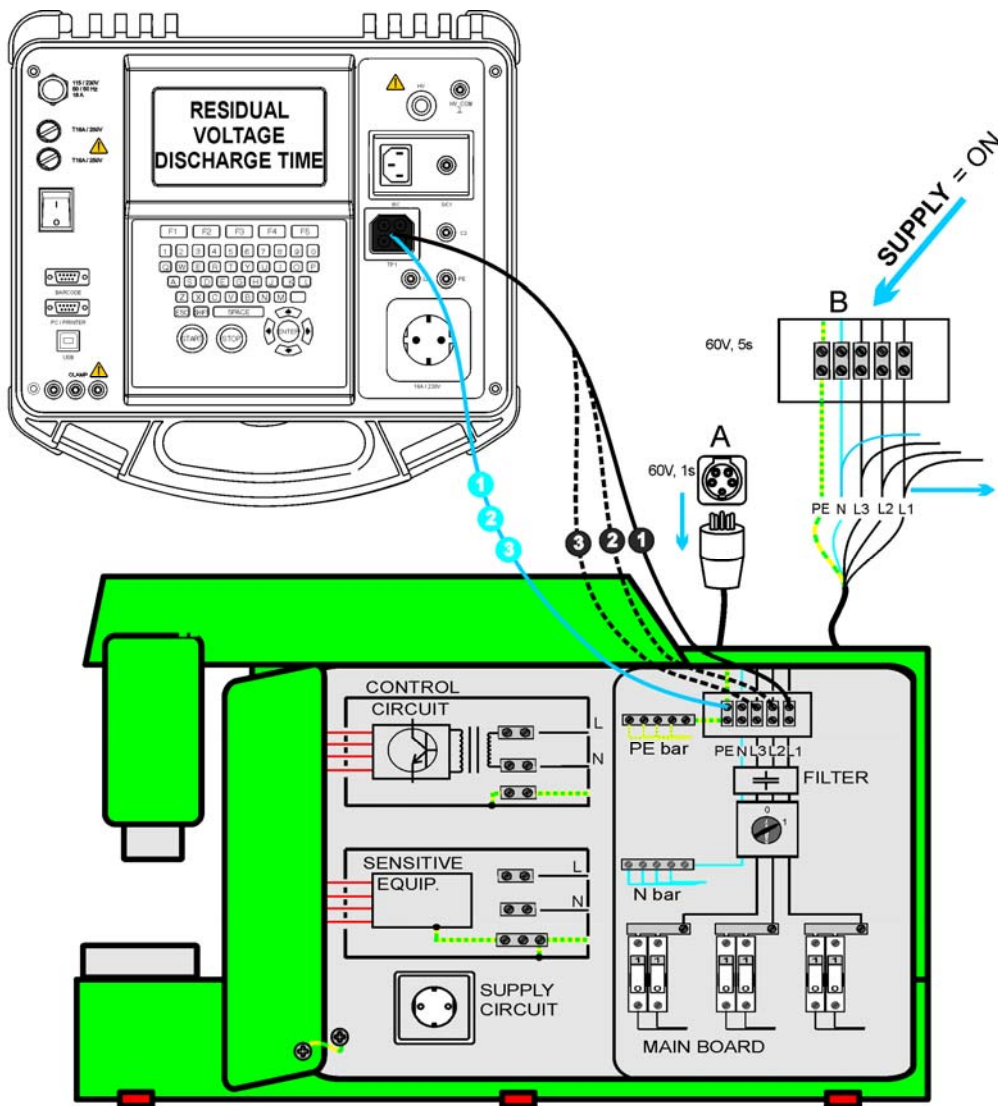

Discharging time test

**Trip out current measurement procedure**

- Select the **Discharging Time** single test.
- Set test **parameters**.
- Connect** three wire test cable to the TP1 test port on the instrument.
- Connect** L and N wires of the three wire test cable to terminals to be tested.
- Press the **START** key to start the measurement.
- Wait** until **“Ready”** is displayed
- Disconnect** the switchboard. **“Wait”** is displayed until the residual voltage drops below 120V. If the voltage at disconnection moment is too low to get an accurate result **“Repeat”** is displayed. The measurement must be repeated.
- Press **SAVE** (F4) key for storing the result (optional).

**Interpretation of the “Repeat” message**

It is not possible to differentiate between a disconnection moment at very low voltage and a switchboard with a very low discharging time. In both cases the reading will be 0.0 s together with the “Repeat” warning. If after few repetitions the result is always 0.0 s with the “Repeat” message it can be considered as a valid 0.0 s result. A 0.0 s reading without the “Repeat” message is a valid result.

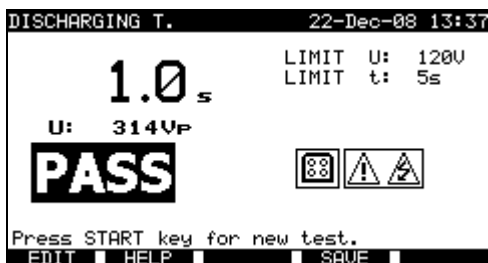

*Examples of discharging time measurement results*

Displayed results:

Main result ..... Discharging time,  
 U ..... Peak voltage value

**Notes:**

- Consider any displayed warning before starting the test!

**10.2.6 Voltage**

Voltages and their frequency are measured in this menu. If a three-phase rotary field is detected its direction is displayed. The phase sequence measurement conforms to the EN 61557-7 standard.

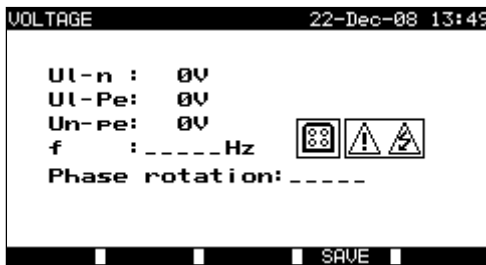

Voltage menu

**Test parameters for Voltage single test**

There are no parameters to be set in this function.

**Test circuit for Voltage test**

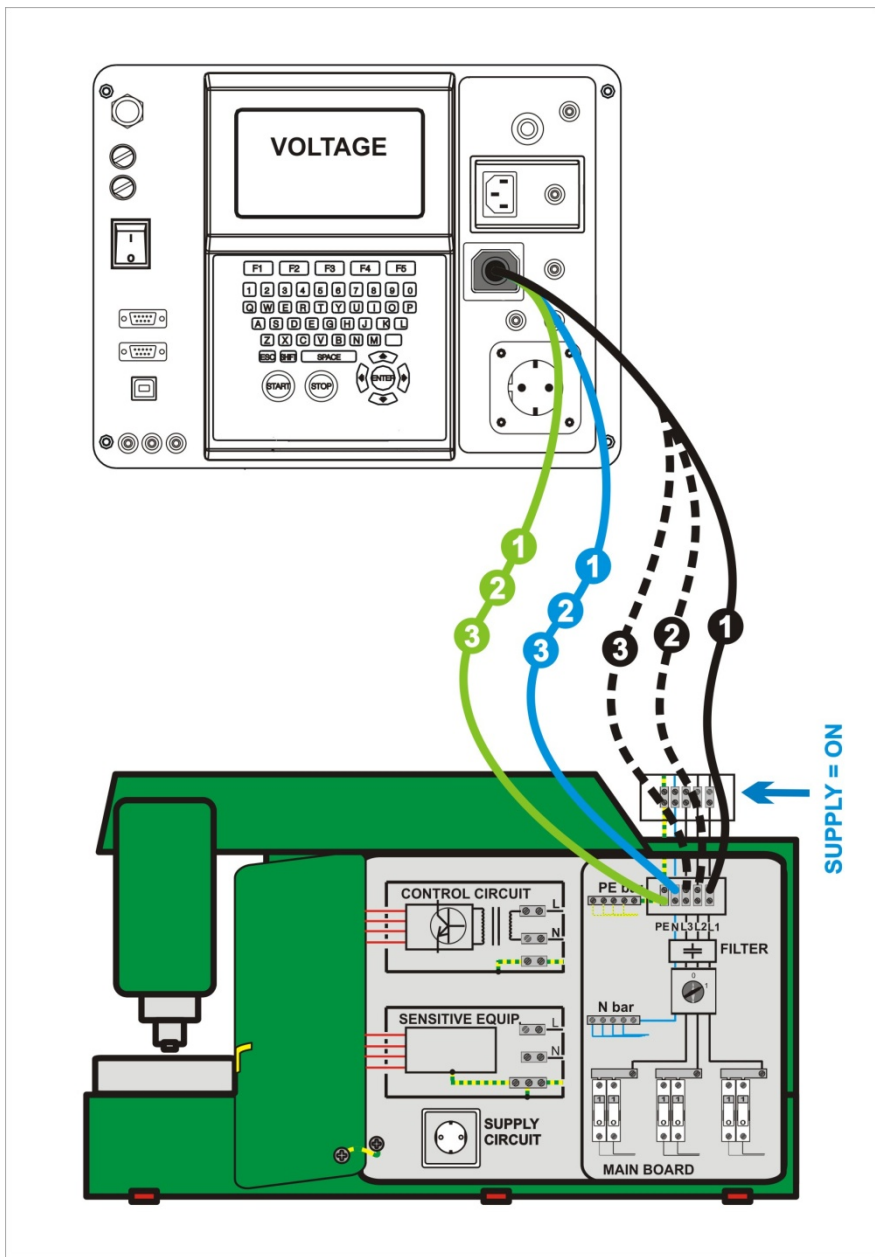

Voltage test

**Voltage/ rotary filed measurement procedure**

- Select the **Voltage** single test.
- The measurement starts immediately after entering in the Voltage menu.
- Connect** three wire test cable to the TP1 test port on the instrument.
- Connect** L and N and PE wires of the three wire test cable to terminals to be tested (L, N, PE for single phase and L1, L2, L3 for three phase systems)
- Press **SAVE** (F4) key for storing the result (optional).

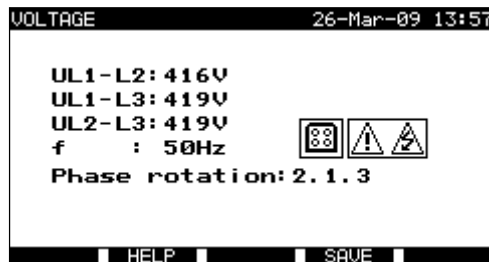
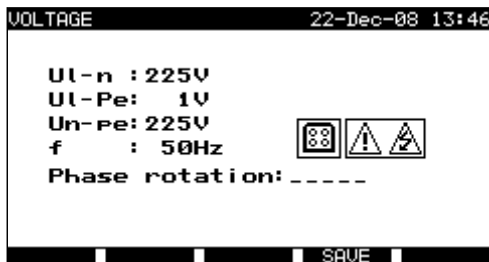

*Examples of voltage measurement results*

Displayed results for single phase system:

- UL-n ..... Voltage between phase and neutral conductors,
- UL-pe ..... Voltage between phase and protective conductors,
- Un-pe ..... Voltage between neutral and protective conductors,
- f ..... frequency.

Displayed results for three-phase system:

- UL1-L2 ..... Voltage between phases L1 and L2,
- UL1-L3 ..... Voltage between phases L1 and L3,
- UL2-L3 ..... Voltage between phases L2 and L3,
- Phase rotation: 1.2.3.... Correct connection – CW rotation sequence,
- Phase rotation: 2.1.3.... Invalid connection – CCW rotation sequence,
- f ..... frequency.

**Notes:**

- Consider any displayed warning before starting test!

**10.2.7 RCD test**

Description in chapter 9.2.6 RCD tests can be used as reference.

**10.2.8 PRCD test**

Description in chapter 6.2.10 PRCD test can be used as reference.

**10.2.9 Functional test**

In its simplest form a functional check is simply a check to ensure that the switchboard is working properly.

**Scope of test**

Check following items while the switchboard is operating:

- Temperature regulators, monitors,
- RCDs and other disconnection devices
- Operation of functional disconnection devices,
- Operation of switches, lamps, keys
- Rotating parts, motors, pumps
- Power consumption
- Etc.

Especially safety relevant functions should be checked.

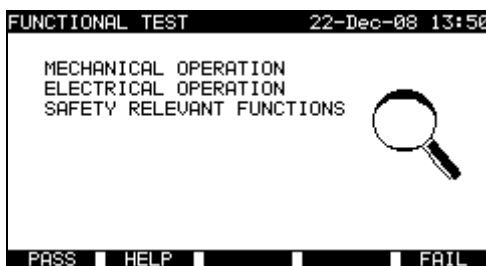

*Functional test menu*

### Functional test procedure

- Select the **Functional test** function.
- Perform **visual inspection** of the switchboard functionality.
- Commit **PASS** (F1) or **FAIL** (F5) ticker manually.
- Save result with **SAVE** (F4) key (optional).

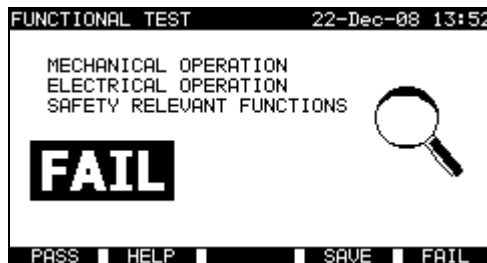
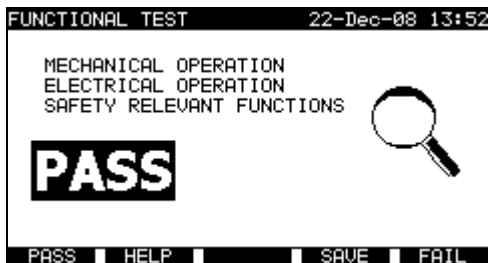

*Examples of functional test results*

### 10.2.10 Power

Descriptions in chapter 6.2.11 *Power/ Functional tests* can be used as reference.



## 11 All tests operating mode

The **All tests operating mode** is primarily intended for testing of electrical safety of all kinds of electrical equipment.

All measurements available in the instrument can be started from this operating mode. For each single test all available parameters can be set.

After entering the **All testing menu** the following options are displayed:

Single test menu (see 11.1),  
Memory operations (see 12.),

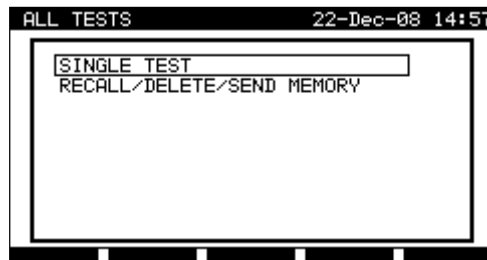

Main menu

Keys:

▼ / ▲	Select the operating mode.
ENTER	Enters selected mode.

**Note:**

- Press ESC key one or more times to return to All testing main menu from any submenu

### 11.1 Single tests (All tests) menu

All single tests available in the instrument can be started form the Single tests menu.

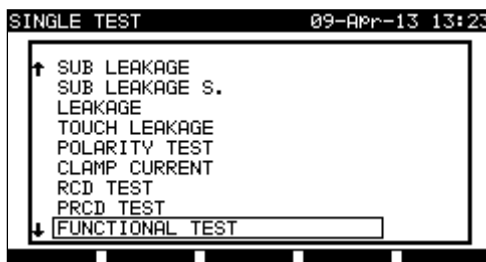

Single test menu

Keys:

▼ / ▲	Select the test / measuring function: <Visual test>, Visual inspections. <Continuity>, Continuity of protective conductors tests. <Insulation>, Insulation resistance. <Insulation-S.>, Insulation resistance, Class II parts. <Sub Leakage>, Substitute leakage current. <Sub Leakage-S>, Substitute leakage current, Class II parts.
-------	--

	<p>&lt;<b>Leakage</b>&gt;, Differential leakage current.          &lt;<b>Touch Leakage</b>&gt;, Touch leakage current.          &lt;<b>Polarity test</b>&gt;, Polarity of IEC cords.          &lt;<b>Clamp current</b>&gt;, Load and leakage currents with current clamp.          &lt;<b>RCD test</b>&gt;, Tests of portable and standard residual current devices.          &lt;<b>PRCD test</b>&gt; Tests of portable residual current devices,          &lt;<b>Functional test</b>&gt;, Functional inspection.          &lt;<b>HV-test</b>&gt;, High Voltage tests.          &lt;<b>ZI (L-N)</b>&gt;, Line impedance tests.          &lt;<b>Zs (L-Pe)</b>&gt;, Loop impedance tests.          &lt;<b>Voltage</b>&gt;, Voltage, frequency and rotary field tests.          &lt;<b>Discharging time</b>&gt;, Discharging time tests.          &lt;<b>Power</b>&gt;, Measurement of device power consumption.</p>
<b>ENTER</b>	Enters selected test.
<b>ESC</b>	Returns to Main menu.

**Note:**

- Unlike in PAT testing mode all single test results and parameters can be stored for documentation purposes (view *chapter 12.1* for more information).

**11.1.1 Visual test**

Descriptions in chapters *9.2.1 Visual test* and *10.2.1 Visual test* can be used as reference.

**11.1.2 Continuity of protective conductors**

Descriptions in chapters *9.2.2 Continuity* and *10.2.2. Continuity* can be used as reference.

**11.1.3 Insulation resistance**

Descriptions in chapters *6.2.2 Insulation resistance*, *9.2.3 Insulation resistance* and *10.2.3. Insulation resistance* can be used as reference.

**11.1.4 Insulation resistance –S**

Description in chapter *6.2.3 Insulation resistance-S* can be used as reference.

**11.1.5 Substitute leakage current**

Description in chapter *6.2.4 Substitute leakage currents* can be used as reference.

**11.1.6 Substitute leakage current - S**

Description in chapter *6.2.5 Substitute leakage-S* can be used as reference.

**11.1.7 Leakage current**

Description in chapter *6.2.6 Differential leakage current* can be used as reference.

### 11.1.8 Touch leakage current

Description in chapter 6.2.7 *Touch Leakage* can be used as reference.

### 11.1.9 Polarity test

Description in chapter 6.2.8 *Polarity test* can be used as reference.

### 11.1.10 Clamp current test

Description in chapter 6.2.9 *Clamp current test* can be used as reference.

### 11.1.11 RCD test

Description in chapter 9.2.6 *RCD tests* can be used as reference.

### 10.2.12 PRCD test

Description in chapter 6.2.10 *PRCD test* can be used as reference.

### 11.1.13 Functional test

Descriptions in chapters 6.2.11 *Power/ Functional tests*, 9.2.9 *Functional test* and 10.2.8 *Functional test* can be used as reference.

### 11.1.14 HV test

Descriptions in chapter 9.2.4 *High Voltage withstanding test* and 10.2.4 *High Voltage withstanding test* can be used as reference.

### 11.1.15 Line impedance and prospective short circuit current test

The instrument measures internal impedance of the line – neutral or line – line loop and calculates the prospective short circuit current. The results can be compared to limit values set on base of selected protective circuit breakers. The measurement complies with requirements of the standard EN 61557-3.

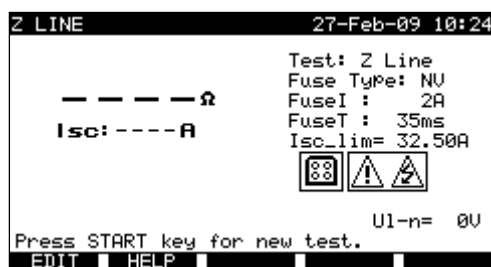

Line impedance menu

#### Test parameters for line impedance measurement

Test	Type of test [Z LINE, Z mΩL-N**, Z mΩL-L**]
Fuse type	Selection of <b>fuse type</b> [*F, NV, Gg, B, C, K, D]
Fuse I	<b>Rated current</b> of selected fuse
Fuse T.	Maximum <b>breaking time</b> of selected fuse
Isc_lim	Minimum short circuit <b>current</b> for selected fuse combination.

»\*F« means no fuse selected.

\*\* See chapter 11.1.14.1 for low line impedance measurement procedure.

### Test circuit for line impedance measurement

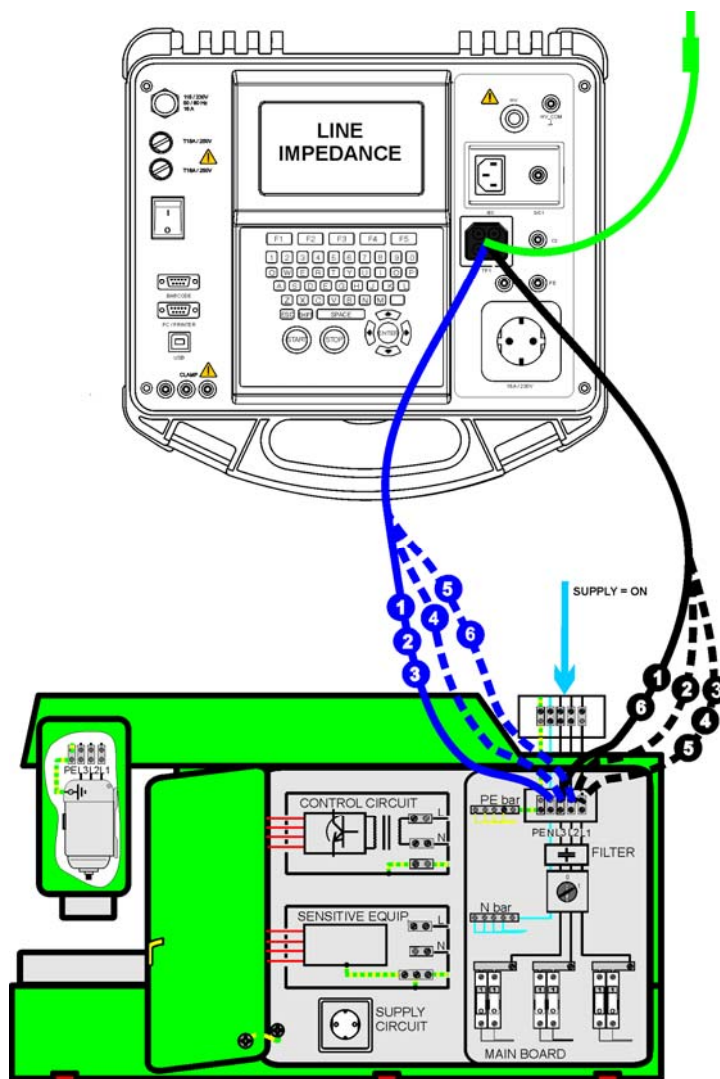

*Measurement of line impedance*

### Line impedance measurement procedure

- Select the **Z LINE** single test.
- Select **type** of test.
- Set test **parameters**.
- Connect** the three wire test lead to the TP1 port on the instrument.
- Connect** the three-wire test lead to L, N and PE terminals of the machine.
- Press the **START** key for the measurement.
- Press **SAVE** (F4) for storing the result (optional).

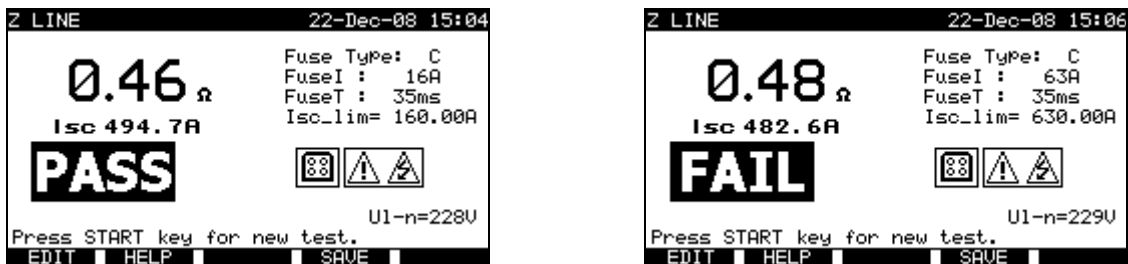

Examples of line impedance measurement results

Displayed results:

- Main result ..... Line impedance,
- Isc ..... Prospective fault current,
- U1-n ..... Voltage UL-N

Prospective short circuit current  $I_{SC}$  is calculated from measured impedance as follows:

$$I_{SC} = \frac{Un \times k_{SC}}{Z}$$

where:

Un Nominal  $U_{L-PE}$  voltage (see table below),

$U_n$	Input voltage range (L-N or L1-L2)
110 V	$(93 V \leq U_{L-N} < 134 V)$
230 V	$(185 V \leq U_{L-N} \leq 266 V)$
400 V	$(321 V < U_{L-N} \leq 485 V)$

**Note:**

- High fluctuations of mains voltage can influence the measurement results field. In this case it is recommended to repeat few measurements to check if the readings are stable.

**11.1.15.1 Low line impedance**

The measurement is performed with Impedance adapter A1143. It is recognized in Z-LINE and Z-LOOP functions. With this adapter, low impedances from few mΩ and up to 19.99 Ω can be measured. The measurement is covered by requirements of the EN 61557-3 standard.

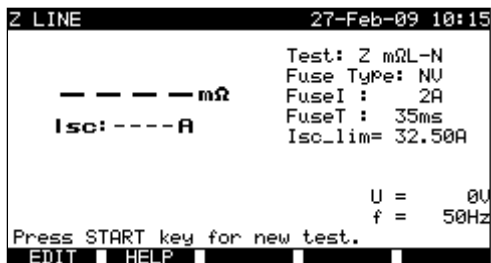

Impedance adapter connected

**Test parameters for low line impedance measurement**

Function Z-LINE	
Test	<b>Impedance function</b> [Z mΩ L-N, Z mΩ L-L]
FUSE type	Selection of <b>fuse type</b> [*F, NV, gG, B, C, K, D]
FUSE I	<b>Rated current</b> of selected fuse.
FUSE T	Maximum <b>breaking time</b> of selected fuse.
Isc_lim	Minimum short circuit <b>current</b> for selected fuse combination.

See Appendix A for reference fuse data.

\*F Means no fuse selected.

Additional key:

<b>F2</b>	Toggles between result screens.
-----------	---------------------------------

**Test setup for low line impedance measurement**

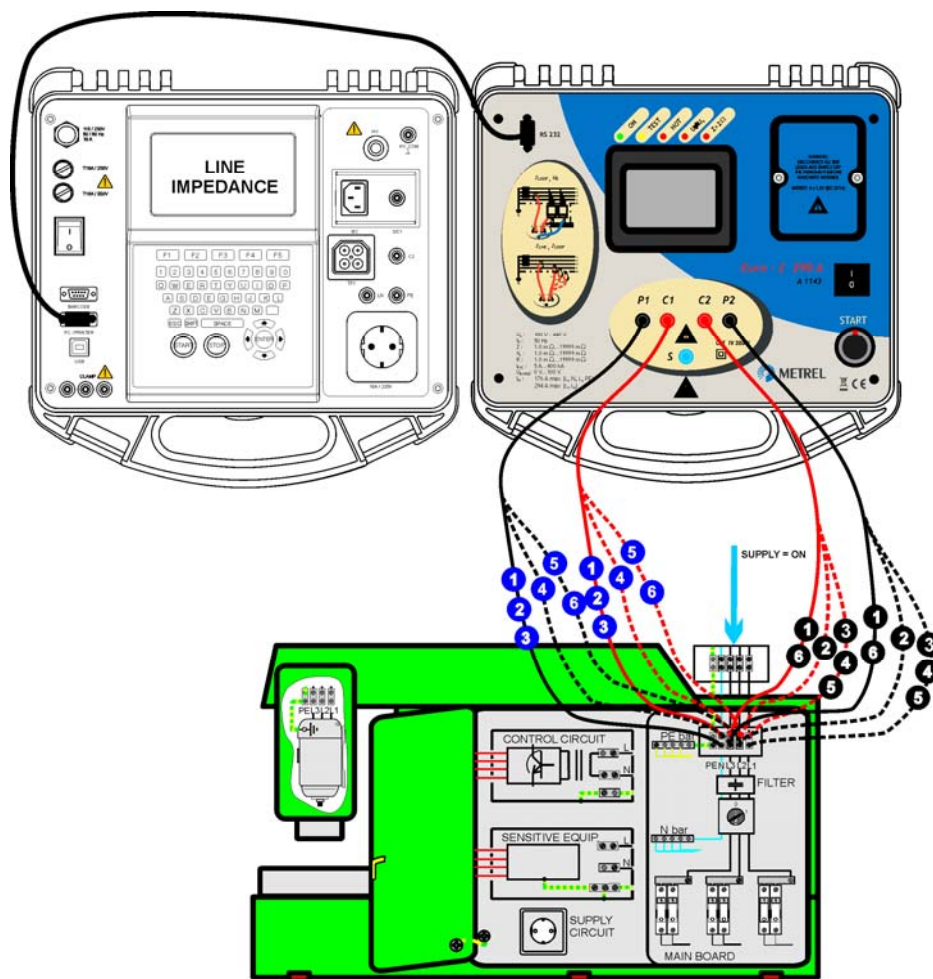

*Connection of impedance adapter to the instrument*

**Low line impedance measuring procedure**

- ❑ **Connect** Impedance adapter to the instrument (see *figure above*).
- ❑ Select the **Z-LINE** function.
- ❑ Enable and set **fuse** type (optional).
- ❑ Power **ON** the Impedance adapter (ON/OFF key, green LED lits).
- ❑ **Connect** Impedance adapter to tested installation.
- ❑ Press the **TEST** key for measurement.
- ❑ **Store** the result (optional).

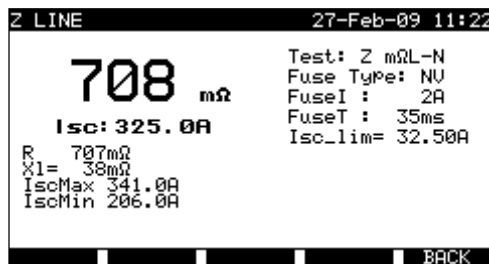

*Impedance L - N*

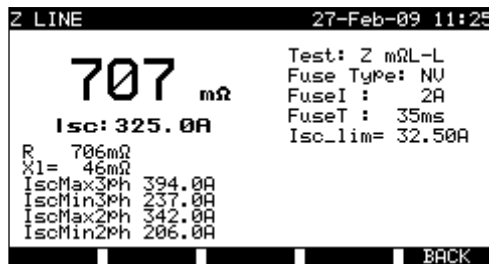

*Impedance L - L*

*Examples of low line measurement results*

Displayed results:

- Z ..... Line / loop impedance,
- Isc ..... Prospective short-circuit current,
- R ..... Resistive part of line impedance,
- Xl ..... Reactive part of line impedance.

The following parameters are displayed in sub-screen for single-phase line impedance measurement:

- IscMaxL-N ..... Maximum prospective short-circuit current.
- IscMinL-N ..... Minimum prospective short-circuit current.
- IscStd..... Standard prospective short-circuit current.

When testing phase-to-phase line impedance the following parameters are displayed in sub-screen:

- IscMax3Ph ..... Maximum three-phase prospective short-circuit current.
- IscMin3Ph ..... Minimum three-phase prospective short-circuit current.
- IscMax2Ph ..... Maximum two-phase prospective short-circuit current.
- IscMin2Ph ..... Minimum two-phase prospective short-circuit current.

IscStd..... Standard prospective short-circuit current.

**Notes:**

- ❑ For application and technical data of the Impedance adapter A1143 see its user manual 20750859.
- ❑ High fluctuations of mains voltage can influence the measurement results.
- ❑ Check adapter indications in case the abort  symbol appears after the start of measurement.

### **11.1.16 Loop impedance test and prospective fault current**

Descriptions in chapter 9.2.5 *Loop impedance and prospective fault current* can be used as reference.

### **11.1.17 Voltage**

Descriptions in chapters 9.2.8 *Voltage* and 10.2.6 *Voltage* can be used as reference.

### **11.1.18 Discharging time**

Descriptions in chapter 9.2.7 *Discharging Time* and 10.2.5 *Discharging Time* can be used as reference.

### **11.1.19 Power**

Descriptions in chapter 6.2.11 *Power/ Functional tests* can be used as reference.



## 12 Working with results in Machine testing, Switchgear testing and All tests operating mode

### 12.1 Memory organization

The Machine, Switchgear and All tests operating mode are sharing the same memory structure. Because of differences in the testing procedures and number of test points in machines and switchgears this memory structure differs and is separated from that for the PAT testing operating mode.

The memory structure is divided into **Memory locations – Projects**. There is no limit for storing single tests into each Project.

Each Memory location - Project includes a header where general data can be stored:

- Device number and its name,
- Test site and location,
- Retest period,
- Repairing code,
- Comments.

Two lines of text (level 1 and level 2) can be added to each measurement. The texts are usually used to describe the location of measurement.

Stored data and measurements can be:

- Recalled and viewed,
- Sent to PC,
- Test report can be printed out to serial printer.

### 12.2 Saving single test results

A single test can be saved by pressing **SAVE** (F4) key after a single test was carried out. The **Project Save results** menu displays the memory location - Project number where the last single test was saved will be offered.

The memory location – Project number header is displayed first. Before storing the single test into instruments memory it is possible to edit the Project header.

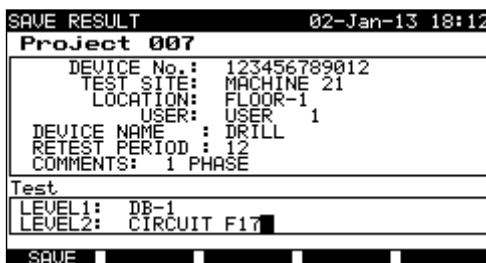

*Project Save results menu*

Keys:

▼ / ▲	Selects the item.
-------	-------------------

< / >, alphanumeric	Edits data.
<b>SAVE</b> (F1)	Saves test results and returns to last single test menu.
<b>UNDO</b> (F2)	Undoes changes.
<b>LIST</b> (F5)	Enters list of pre-defined names.
<b>ESC</b>	Returns to Main menu.

In the **Device no.** field up to 10 numeric characters can be entered. The **Device number** can also be scanned with a barcode reader.

In the **Test site, Location** and **Device name** fields, up to 15 alpha-numeric or special characters can be entered. Names can also be selected from the list of 100 predefined names for each parameter.

In **Retest period** field, at the most 2 numeric characters can be entered to represent the number of months between retest.

In the **Comments** field, up to 20 alpha-numeric or special characters can be entered.

**Notes:**

- **User** field cannot be edited (this must be selected from the *Users/ Device data* menu of the instrument).

### 12.3 Recalling projects

Select Recall/delete/send memory in Machine testing (Switchgear testing, All tests) menu by using **▲** and **▼** keys and press ENTER key to confirm. Search projects menu is displayed.

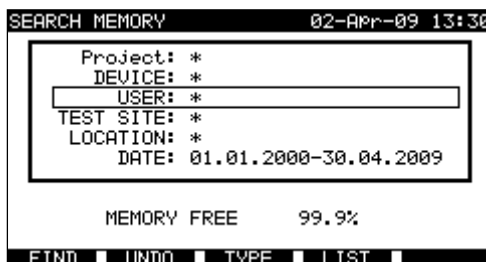

*Search projects menu*

When searching for stored results the following filters can be used to narrow the hits:

- project
- DUT number,
- test site,
- location,
- date from and date to,
- user.

By using **▲** and **▼** keys select the filter you want to edit.

Keys:

<b>▼ / ▲</b>	Selects parameter line.
< / >, Alphanumeric	Edits parameter line.
<b>FIND</b> (F1)	Starts search after filters are setup correctly.
<b>UNDO</b> (F2)	Undoes latest change.

<b>TYPE (F3)</b>	Selects type of parameter line.
<b>ESC</b>	Returns to Main menu.

**Notes:**

- Project parameter line:  
If a project number is selected all other set filters will be ignored. If »\*« is set in the Project filter other set filters will be active.
- All parameter lines except Project:  
To change the selected filter line type, press the F3 function key and the »filter type« will become highlighted (e.g. DEVICE). The ◀ and ▶ cursor keys can then be used to change the filter type and by pressing ENTER key the choice can be confirmed. Once the filter types have been set up, the data required to filter the files can be inserted. Filter information can be inserted via the alphanumeric keypad or, in some filter fields such as user, can also be selected from a predefined list by pressing the F4 function key. The device number field can also be read using a barcode reader.
- By placing a »\*« (shift + “2”) in a particular field, tells the instrument not to search the associated filter field. When searching, the instrument will therefore ignore data in this parameter and go on to find all the devices that conform to data placed in the other filter fields.
- To find all stored results, enter »\*« in the all fields (excluding DATE where the correct from and to dates must be entered).

When the search filters have been correctly set up, a search can be performed by pressing the F1 function key. If the search filters are set up correctly and the devices exist in the units memory, the **Recall results menu** will be displayed.

While recalling stored results, the instrument shows a bar graph and a ratio of files found compared to files stored in memory (e.g. 7/11 implies 7 results have been found to meet the filter criteria out of a potential 11 results stored in the flash memory).

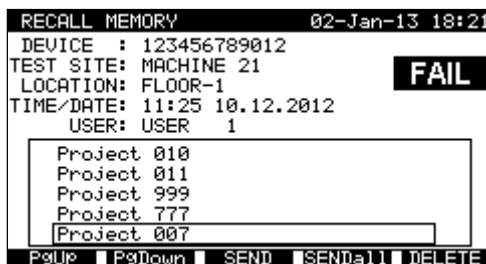

*Recall project menu*

Once the Projects have been found, the ▲ and ▼ keys and PgUp (F1) and PgDown (F2) keys can be used to scroll through the filtered list of Projects.

More information relating to the selected Project can be viewed by pressing the ENTER key on the appropriate Project. It can be scrolled through test results by using the PgUp (F1) and PgDown (F2) keys. The MORE (F5) key can be used to view additional Project data.

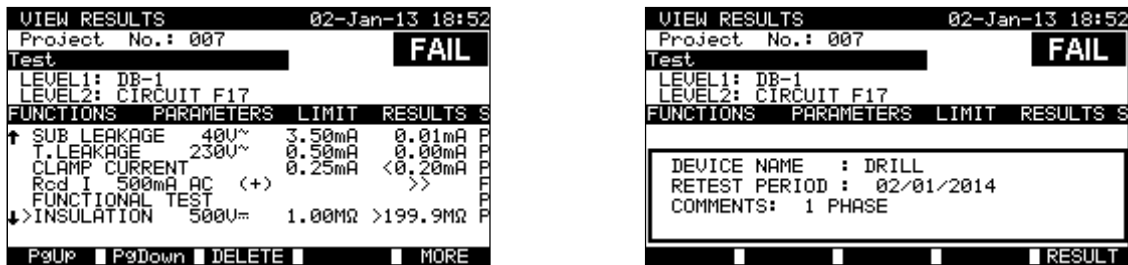

View Project results menus

Some single tests contain more parameters and results that can not be seen in one display line. In this case »>>« is in the result column. For view the results select the single test with ▲ and ▼ keys and press >> (F4) key. By pressing and >> (F4) key again the instrument returns to the previous menu.



View single test with more results

Use the ESC key to return to Recall projects or Search projects menus. From the **Recall projects menu** stored data can be downloaded to a PC, printed out to a serial printer or deleted from the memory.

### 12.4 Deleting single test results

In View Project results menu select single test by using the PgUp (F1), PgDown (F2) keys, ▲ and ▼ cursor keys. The selected single test is marked with the »>>« symbol.

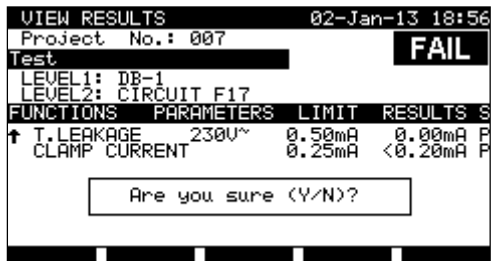

Deleting single test results – confirmation screen

Press DELETE (F3) key to enter confirmation screen for deleting the selected single test. Press Y to delete.

### 12.5 Deleting project(s)

All data in a stored project can also be deleted from the memory.

Recall the result(s) you want to delete (Refer to chapter 12.2 *Recalling projects* for detailed information on recalling results).

In the **Recall project** menu, press DELETE (F5) key. **Delete results** menu will be displayed.

In this menu the following functions can be performed.

- DELETE: deletes the selected project in *Recall projects* menu,
- DELETE SELECTED: deletes all projects found from searching the memory of the instrument,
- DELETE ALL: clears all stored projects.

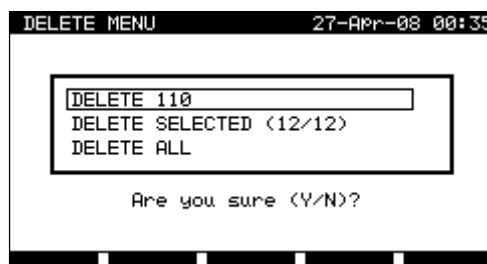
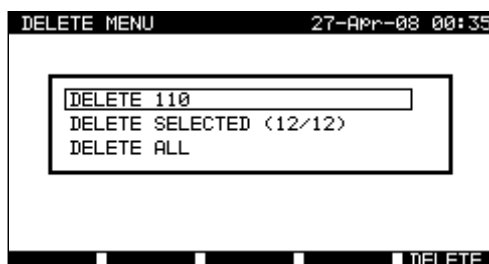

*Delete results menu*

Keys:

▼ / ▲	Selects deleting option.
<b>DELETE (F5)</b>	Deletes selected projects.
<b>ESC</b>	Returns to memory Recall projects menu.

Confirm the selected option by using Y key. After performing the selected option, instrument returns to **Recall results** menu accepting the new memory state. If you don't want delete the results, press the N key in **Delete results** menu. Instrument returns to **Recall results** menu without any changes.

## 12.6 Downloading and printing results

The instrument offers the following possibilities to send data in selected (one or more) projects to:

- PC ,
- serial printer for fast report printing,
- It is possible to send data of selected to selected output after recalling stored projects from the instrument memory.

To send data of selected project press SEND (F3) in the **Recall projects menu**

To send data of all projects found from searching the memory of the instrument press SEND ALL (F4) in the **Recall projects menu**

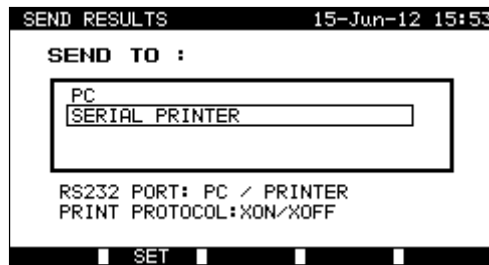
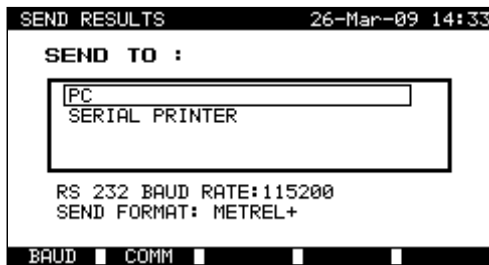

Send results menu

Keys:

▼ / ▲	Selects activity.
<b>ENTER</b>	Starts sending to selected output.
<b>(F1), (F2)</b>	Modification of communication parameters.
<b>ESC</b>	Returns to memory recall menu.

**Parameters for SEND TO: PC**

Keys:

<b>BAUD (F1)</b>	Opens menu for selection of Baud Rate.
<b>COMM (F2)</b>	Opens menu for interface selection (RS232 or USB).

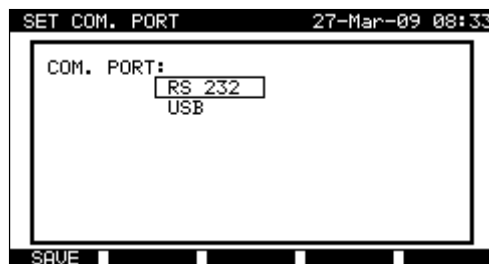
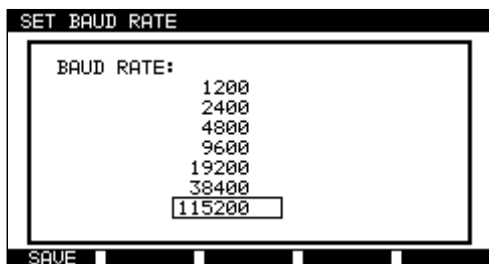

Communication ports settings

Keys

▼ / ▲	Selects the option.
<b>SAVE (F1)</b>	Saves selected option.
<b>ESC</b>	Returns to <i>Send results</i> menu.

**Parameters for SEND TO: serial printer**

Keys:

<b>SET (F2)</b>	Opens menu for selection of data transfer control option.
-----------------	---

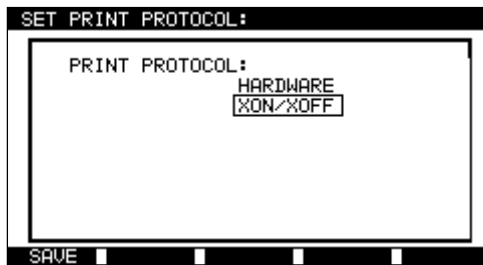

Serial printer settings

Keys

▼ / ▲	Selects the option.
<b>SAVE</b> (F1)	Accepts selected option.
<b>ESC</b>	Returns to <i>Send results</i> menu.

```

.....
METREL
Testing laboratory
Horjul, Slovenia
.....

DEVICE 11072010
TEST SITE METREL
LOCATION OFFICE 1
TIME/DATE 09:31 11-JUL-2008
USER TOMAZ
RESULT: PASS
-----
VISUAL PASS
EARTH BOND It: 10A~ Rlim: 0.10 Ohm
1. R = 0.03 Ohm PASS
INSULATION Ut: 500V Rlim: 1.00 MOhm
1. R = 178.9 MOhm PASS
LEAKAGE Ut: 230V~ Ilim: 0.75 mA
1. I = 0.23 mA PASS
POWER
1. P = 2.01KVA PASS
DEVICE NAME: APP 1
RETEST PERIOD : 11/07/2009
REPAIRING CODE: 021268505
COMMENTS: -
=====
=

END OF DATA
    
```

```

PRINT HEDER FOR MPL TESTING
2ND LINE
LAST HEADER LINE

Project No.:          003
DEVICE No.:          33333
TEST SITE
LOCATION
TIME/DATE          11:23 09-APR-2009
USER              USER 1
-----
DISCHARGING T.
1. Time            0.2s PASS
2. Up              316Vp
Z Loop Fuse: *F
1. Z =             3.85 Ohm
2. Isc =           63.3A
Z Loop Fuse: NV    16A 35ms
1. Z =             3.76 Ohm FAIL
2. Isc =           64.8A FAIL
RCD/FI Auto      10mA AC
1. Idn x1 0       >300ms FAIL
2. Uc =           0.1V
VOLTAGE
1. U1-n :          233V
2. U1-Pe:          233V
3. Un-pe:          1V
DEVICE NAME :
RETEST PERIOD :
COMMENTS:
=====
END OF DATA
    
```

An example of data sent to serial printer

Notes:

- ❑ When working with serial printers, the baud rate is set by default to 9600 bps.
- ❑ Software transfer control uses XON (CTRL-Q) and XOFF (CTRL-S) characters.
- ❑ Hardware transfer control uses DTR line.
- ❑ Back side port supports only (XOn/XOff) software transfer control.

## 13 Maintenance

### 13.1 Periodic calibration

It is essential that all measuring instruments are regularly calibrated in order for the technical specification listed in this manual to be guaranteed. We recommend an annual calibration. The calibration should be done by an authorized technical person only.

### 13.2 Fuses

There are two fuses available from front panel:

F1 = F2 = T 16 A / 250 V (32 × 6,3 mm): intended for instrument protection.

If the instrument does not respond after connection to mains supply, disconnect the mains supply and accessories and then check these fuses. For position of fuses refer to chapter 2.1 *Front panel*.

#### Warning!

- Switch off the instrument and disconnect all test accessories and mains cord before replacing the fuses or opening the instrument.**
- Replace blown fuse with the same type.**

### 13.3 Service

For repairs under or out of warranty time please contact your distributor for further information.

Unauthorized person is not allowed to open the MultiservicerXA instrument. There are no user replaceable parts inside the instrument.

### 13.4 Cleaning

Use a soft, slightly moistened cloth with soap water or alcohol to clean the surface of MultiservicerXA instrument. Leave the instrument to dry totally before using it.

#### Notes:

- Do not use liquids based on petrol or hydrocarbons!
- Do not spill cleaning liquid over the instrument!



## 14 Instrument set and accessories

### Standard set of the instrument

- › Instrument MI 3321 Multiservicer XA
- › Bag for accessories
- › HV test probe
- › Plug test cable 1.5 m
- › Three wire test cable 3 m
- › Test lead (1.5 m, green)
- › Test lead (1.5 m, black)
- › Test lead (1.5 m red)
- › Test lead (4 m red)
- › Test tip (blue)
- › Test tip (green)
- › Test tip (black)
- › 3 Alligator clips (black)
- › PC software PATLink PRO with RS232 and USB cables
- › User manual
- › Production verification data

### Optional accessories

See the attached sheet for a list of optional accessories that are available on request from your distributor.

## A Appendix A – Preprogrammed autotests

### Pre-programmed autotest sequences

No.	Name	Description
1	<b>CI_1_Iso</b>	Testing according to VDE 0701-0702. Class 1 device. Insulation resistance and substitute leakage current measurements are selected.
2	<b>CI1_Iso_BLT</b>	Testing according to VDE 0701-0702. Class 1 device with isolated accessible conductive parts. Insulation resistance and substitute leakage current measurements are selected.
3	<b>CI_1_Ia</b>	Testing according to VDE 0701-0702. Class 1 device. Differential leakage current measurement is selected.
4	<b>CI_1_Ia_BLT</b>	Testing according to VDE 0701-0702. Class 1 device with isolated accessible conductive parts. Differential leakage current and touch leakage current measurements are selected.
5	<b>CI_2_Iso</b>	Testing according to VDE 0701-0702. Class 2 device with isolated accessible conductive parts. Insulation resistance and substitute leakage current measurements are selected.
6	<b>CI_2_Ibs</b>	Testing according to VDE 0701-0702. Class 2 device. Touch leakage current measurement is selected.
7	<b>CI_1_Isola</b>	Testing according to VDE 0701-0702. Class 1 device. Insulation resistance and differential leakage current measurements are selected.
8	<b>CI1_IsolaBLT</b>	Testing according to VDE 0701-0702. Class 1 device with isolated accessible conductive parts. Insulation resistance, differential leakage current and touch leakage current measurements are selected.
9	<b>CI_2_Isolbs</b>	Testing according to VDE 0701-0702. Class 2 device with isolated accessible conductive parts. Insulation resistance and touch leakage current measurements are selected.
10	<b>CI_2</b>	Testing according to VDE 0701-0702. Class 2 device without any isolated accessible conductive parts.
11	<b>CI_3_Iso</b>	Testing according to VDE 0701-0702. Class 3 device with isolated accessible conductive parts.
12	<b>CI_3</b>	Testing according to VDE 0701-0702. Class 3 device without any isolated accessible conductive parts.

## Pre-programmed autotest sequences table

Autotest shortcut code		01	02	03	04
		CI_1_Iso	CI1_Iso_BLT	CI_1_la	CI_1_la_BLT
<b>Visual test</b>		<input checked="" type="checkbox"/>	<input checked="" type="checkbox"/>	<input checked="" type="checkbox"/>	<input checked="" type="checkbox"/>
<b>Earth bond</b>	Output	200 mA	200 mA	200 mA	200 mA
	Limit	0.30 $\Omega$	0.30 $\Omega$	0.30 $\Omega$	0.30 $\Omega$
	Time	5 s	5 s	5 s	5 s
<b>Insulation</b>	Output	500 V	500 V	<input checked="" type="checkbox"/>	<input checked="" type="checkbox"/>
	Limit	1.00 M $\Omega$	1.00 M $\Omega$	<input checked="" type="checkbox"/>	<input checked="" type="checkbox"/>
	Time	5 s	5 s	<input checked="" type="checkbox"/>	<input checked="" type="checkbox"/>
<b>Insulation (probe)</b>	Output	<input checked="" type="checkbox"/>	500 V	<input checked="" type="checkbox"/>	<input checked="" type="checkbox"/>
	Limit	<input checked="" type="checkbox"/>	2.00 M $\Omega$	<input checked="" type="checkbox"/>	<input checked="" type="checkbox"/>
	Time	<input checked="" type="checkbox"/>	5 s	<input checked="" type="checkbox"/>	<input checked="" type="checkbox"/>
<b>Sub leakage</b>	Output	40 V	40 V	<input checked="" type="checkbox"/>	<input checked="" type="checkbox"/>
	Limit	3.50 mA	3.50 mA	<input checked="" type="checkbox"/>	<input checked="" type="checkbox"/>
	Time	5 s	5 s	<input checked="" type="checkbox"/>	<input checked="" type="checkbox"/>
<b>Sub leakage (probe)</b>	Output	<input checked="" type="checkbox"/>	40 V	<input checked="" type="checkbox"/>	<input checked="" type="checkbox"/>
	Limit	<input checked="" type="checkbox"/>	0.50 mA	<input checked="" type="checkbox"/>	<input checked="" type="checkbox"/>
	Time	<input checked="" type="checkbox"/>	5 s	<input checked="" type="checkbox"/>	<input checked="" type="checkbox"/>
<b>Differential leakage</b>	Output	<input checked="" type="checkbox"/>	<input checked="" type="checkbox"/>	230 V	230 V
	Limit	<input checked="" type="checkbox"/>	<input checked="" type="checkbox"/>	3.50 mA	3.50 mA
	Time	<input checked="" type="checkbox"/>	<input checked="" type="checkbox"/>	180 s	180 s
<b>Touch leakage</b>	Output	<input checked="" type="checkbox"/>	<input checked="" type="checkbox"/>	<input checked="" type="checkbox"/>	230 V
	Limit	<input checked="" type="checkbox"/>	<input checked="" type="checkbox"/>	<input checked="" type="checkbox"/>	0.50 mA
	Time	<input checked="" type="checkbox"/>	<input checked="" type="checkbox"/>	<input checked="" type="checkbox"/>	180 s
<b>Power</b>	Output	230 V	230 V	230 V	230 V
	Limit	<input checked="" type="checkbox"/>	<input checked="" type="checkbox"/>	<input checked="" type="checkbox"/>	<input checked="" type="checkbox"/>
	Time	180 s	180 s	180 s	180 s
<b>TRMS clamp current</b>	Output	<input checked="" type="checkbox"/>	<input checked="" type="checkbox"/>	<input checked="" type="checkbox"/>	<input checked="" type="checkbox"/>
	Limit	<input checked="" type="checkbox"/>	<input checked="" type="checkbox"/>	<input checked="" type="checkbox"/>	<input checked="" type="checkbox"/>
	Time	<input checked="" type="checkbox"/>	<input checked="" type="checkbox"/>	<input checked="" type="checkbox"/>	<input checked="" type="checkbox"/>
<b>Polarity test</b>		<input checked="" type="checkbox"/>	<input checked="" type="checkbox"/>	<input checked="" type="checkbox"/>	<input checked="" type="checkbox"/>



## Pre-programmed autotest sequences table (cont'd)

Autotest shortcut code		05	06	07	08
		CI_2_Iso	CI_2_lbs	CI_1_Isola	CI1_IsolaBLT
<b>Visual test</b>		<input checked="" type="checkbox"/>	<input checked="" type="checkbox"/>	<input checked="" type="checkbox"/>	<input checked="" type="checkbox"/>
<b>Earth bond</b>	Output	<input checked="" type="checkbox"/>	<input checked="" type="checkbox"/>	200 mA	200 mA
	Limit	<input checked="" type="checkbox"/>	<input checked="" type="checkbox"/>	0.30 $\Omega$	0.30 $\Omega$
	Time	<input checked="" type="checkbox"/>	<input checked="" type="checkbox"/>	5 s	5 s
<b>Insulation</b>	Output	<input checked="" type="checkbox"/>	<input checked="" type="checkbox"/>	500 V	500 V
	Limit	<input checked="" type="checkbox"/>	<input checked="" type="checkbox"/>	1.00 M $\Omega$	1.00 M $\Omega$
	Time	<input checked="" type="checkbox"/>	<input checked="" type="checkbox"/>	5 s	5 s
<b>Insulation (probe)</b>	Output	500 V	<input checked="" type="checkbox"/>	<input checked="" type="checkbox"/>	500 V
	Limit	2.00 M $\Omega$	<input checked="" type="checkbox"/>	<input checked="" type="checkbox"/>	2.00 M $\Omega$
	Time	5 s	<input checked="" type="checkbox"/>	<input checked="" type="checkbox"/>	5 s
<b>Sub leakage</b>	Output	<input checked="" type="checkbox"/>	<input checked="" type="checkbox"/>	<input checked="" type="checkbox"/>	<input checked="" type="checkbox"/>
	Limit	<input checked="" type="checkbox"/>	<input checked="" type="checkbox"/>	<input checked="" type="checkbox"/>	<input checked="" type="checkbox"/>
	Time	<input checked="" type="checkbox"/>	<input checked="" type="checkbox"/>	<input checked="" type="checkbox"/>	<input checked="" type="checkbox"/>
<b>Sub leakage (probe)</b>	Output	40 V	<input checked="" type="checkbox"/>	<input checked="" type="checkbox"/>	<input checked="" type="checkbox"/>
	Limit	0.50 mA	<input checked="" type="checkbox"/>	<input checked="" type="checkbox"/>	<input checked="" type="checkbox"/>
	Time	5 s	<input checked="" type="checkbox"/>	<input checked="" type="checkbox"/>	<input checked="" type="checkbox"/>
<b>Differential leakage</b>	Output	<input checked="" type="checkbox"/>	<input checked="" type="checkbox"/>	230 V	230 V
	Limit	<input checked="" type="checkbox"/>	<input checked="" type="checkbox"/>	3.50 mA	3.50 mA
	Time	<input checked="" type="checkbox"/>	<input checked="" type="checkbox"/>	180 s	180 s
<b>Touch leakage</b>	Output	<input checked="" type="checkbox"/>	230 V	<input checked="" type="checkbox"/>	230 V
	Limit	<input checked="" type="checkbox"/>	0.50 mA	<input checked="" type="checkbox"/>	0.50 mA
	Time	<input checked="" type="checkbox"/>	180 s	<input checked="" type="checkbox"/>	180 s
<b>Power</b>	Output	230 V	230 V	230 V	230 V
	Limit	<input checked="" type="checkbox"/>	<input checked="" type="checkbox"/>	<input checked="" type="checkbox"/>	<input checked="" type="checkbox"/>
	Time	180 s	180 s	180 s	180 s
<b>TRMS clamp current</b>	Output	<input checked="" type="checkbox"/>	<input checked="" type="checkbox"/>	<input checked="" type="checkbox"/>	<input checked="" type="checkbox"/>
	Limit	<input checked="" type="checkbox"/>	<input checked="" type="checkbox"/>	<input checked="" type="checkbox"/>	<input checked="" type="checkbox"/>
	Time	<input checked="" type="checkbox"/>	<input checked="" type="checkbox"/>	<input checked="" type="checkbox"/>	<input checked="" type="checkbox"/>
<b>Polarity test</b>		<input checked="" type="checkbox"/>	<input checked="" type="checkbox"/>	<input checked="" type="checkbox"/>	<input checked="" type="checkbox"/>

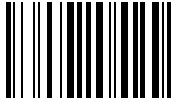

## Pre-programmed autotest sequences table (cont'd)

Autotest shortcut code		09	10	11	12
		CI_2_Isolbs	CI_2	CI_3_Iso	CI_3
<b>Visual test</b>		<input checked="" type="checkbox"/>	<input checked="" type="checkbox"/>	<input checked="" type="checkbox"/>	<input checked="" type="checkbox"/>
<b>Earth bond</b>	Output	<input checked="" type="checkbox"/>	<input checked="" type="checkbox"/>	<input checked="" type="checkbox"/>	<input checked="" type="checkbox"/>
	Limit	<input checked="" type="checkbox"/>	<input checked="" type="checkbox"/>	<input checked="" type="checkbox"/>	<input checked="" type="checkbox"/>
	Time	<input checked="" type="checkbox"/>	<input checked="" type="checkbox"/>	<input checked="" type="checkbox"/>	<input checked="" type="checkbox"/>
<b>Insulation</b>	Output	<input checked="" type="checkbox"/>	<input checked="" type="checkbox"/>	<input checked="" type="checkbox"/>	<input checked="" type="checkbox"/>
	Limit	<input checked="" type="checkbox"/>	<input checked="" type="checkbox"/>	<input checked="" type="checkbox"/>	<input checked="" type="checkbox"/>
	Time	<input checked="" type="checkbox"/>	<input checked="" type="checkbox"/>	<input checked="" type="checkbox"/>	<input checked="" type="checkbox"/>
<b>Insulation (probe)</b>	Output	500 V	<input checked="" type="checkbox"/>	500 V	<input checked="" type="checkbox"/>
	Limit	2.00 M $\Omega$	<input checked="" type="checkbox"/>	0.250 M $\Omega$	<input checked="" type="checkbox"/>
	Time	5 s	<input checked="" type="checkbox"/>	5 s	<input checked="" type="checkbox"/>
<b>Sub leakage</b>	Output	<input checked="" type="checkbox"/>	<input checked="" type="checkbox"/>	<input checked="" type="checkbox"/>	<input checked="" type="checkbox"/>
	Limit	<input checked="" type="checkbox"/>	<input checked="" type="checkbox"/>	<input checked="" type="checkbox"/>	<input checked="" type="checkbox"/>
	Time	<input checked="" type="checkbox"/>	<input checked="" type="checkbox"/>	<input checked="" type="checkbox"/>	<input checked="" type="checkbox"/>
<b>Sub leakage (probe)</b>	Output	<input checked="" type="checkbox"/>	<input checked="" type="checkbox"/>	<input checked="" type="checkbox"/>	<input checked="" type="checkbox"/>
	Limit	<input checked="" type="checkbox"/>	<input checked="" type="checkbox"/>	<input checked="" type="checkbox"/>	<input checked="" type="checkbox"/>
	Time	<input checked="" type="checkbox"/>	<input checked="" type="checkbox"/>	<input checked="" type="checkbox"/>	<input checked="" type="checkbox"/>
<b>Differential leakage</b>	Output	<input checked="" type="checkbox"/>	<input checked="" type="checkbox"/>	<input checked="" type="checkbox"/>	<input checked="" type="checkbox"/>
	Limit	<input checked="" type="checkbox"/>	<input checked="" type="checkbox"/>	<input checked="" type="checkbox"/>	<input checked="" type="checkbox"/>
	Time	<input checked="" type="checkbox"/>	<input checked="" type="checkbox"/>	<input checked="" type="checkbox"/>	<input checked="" type="checkbox"/>
<b>Touch leakage</b>	Output	230 V	<input checked="" type="checkbox"/>	<input checked="" type="checkbox"/>	<input checked="" type="checkbox"/>
	Limit	0.50 mA	<input checked="" type="checkbox"/>	<input checked="" type="checkbox"/>	<input checked="" type="checkbox"/>
	Time	180 s	<input checked="" type="checkbox"/>	<input checked="" type="checkbox"/>	<input checked="" type="checkbox"/>
<b>Power</b>	Output	230 V	230 V	---	---
	Limit	<input checked="" type="checkbox"/>	<input checked="" type="checkbox"/>	<input checked="" type="checkbox"/>	<input checked="" type="checkbox"/>
	Time	180 s	180 s	180 s	180 s
<b>TRMS clamp current</b>	Output	<input checked="" type="checkbox"/>	<input checked="" type="checkbox"/>	<input checked="" type="checkbox"/>	<input checked="" type="checkbox"/>
	Limit	<input checked="" type="checkbox"/>	<input checked="" type="checkbox"/>	<input checked="" type="checkbox"/>	<input checked="" type="checkbox"/>
	Time	<input checked="" type="checkbox"/>	<input checked="" type="checkbox"/>	<input checked="" type="checkbox"/>	<input checked="" type="checkbox"/>
<b>Polarity test</b>		<input checked="" type="checkbox"/>	<input checked="" type="checkbox"/>	<input checked="" type="checkbox"/>	<input checked="" type="checkbox"/>

## METREL GmbH VDE tester test type card

Code	Autotest sequence name and descriptions		Limits	Barcode
01	<b>KI_1_Iso</b>	Testing according to VDE. Class 1 device. Insulation resistance and substitute leakage current measurements are applicable.	Earth bond: 0.30 $\Omega$ Insulation: 1.00 M $\Omega$ Sub leakage: 3.50mA	 A01
02	<b>KI1_Iso_BLT</b>	Testing according to VDE. Class 1 device with isolated accessible conductive parts. Insulation resistance and substitute leakage current measurements are applicable.	Earth bond: 0.30 $\Omega$ Insulation: 1.00 M $\Omega$ Insulation - S: 2.00 M $\Omega$ Sub leakage: 3.50 mA Sub leakage - S: 0.50 mA	 A02
03	<b>KI_1_Ia</b>	Testing according to VDE. Class 1 device. Leakage current measurement is applicable.	Earth bond: 0.30 $\Omega$ Leakage: 3.50 mA	 A03
04	<b>KI_1_Ia_BLT</b>	Testing according to VDE. Class 1 device with isolated accessible conductive parts. Leakage current and touch current measurements are applicable.	Earth bond: 0.30 $\Omega$ Leakage: 3.50 mA Touch leakage: 0.50 mA	 A04
05	<b>KI_2_Iso</b>	Testing according to VDE. Class 2 device with isolated accessible conductive parts. Insulation resistance and substitute leakage current measurements are applicable.	Insulation - S: 2.00 M $\Omega$ Sub leakage - S: 0.50 mA	 A05
06	<b>KI_2_Ibs</b>	Testing according to VDE. Class 2 device. Touch current measurement is applicable.	Touch leakage: 0.50 mA	 A06
07	<b>KI_1_Isola</b>	Testing according to VDE. <i>Class 1 device.</i> Insulation resistance and leakage current measurements are applicable.	Earth bond: 0.30 $\Omega$ Insulation: 1.00 M $\Omega$ Leakage: 3.50 mA	 A07
08	<b>KI1_IsolaBLT</b>	Testing according to VDE. Class 1 device with isolated accessible conductive parts. Insulation resistance, leakage current and touch current measurements are applicable.	Earth bond: 0.30 $\Omega$ Insulation: 1.00 M $\Omega$ Insulation - S: 2.00 M $\Omega$ Leakage: 3.50 mA Touch leakage: 0.50 mA	 A08
09	<b>KI_2_Isolbs</b>	Testing according to VDE. Class 2 device with isolated accessible conductive parts. Insulation resistance and touch current measurements are applicable.	Insulation - S: 2.00 M $\Omega$ Touch leakage: 0.50 mA	 A09

**METREL GmbH VDE tester test type card (cont'd)**

10	<b>KI_2</b>	Testing according to VDE. Class 2 device without any isolated accessible conductive parts.		 A1 0
11	<b>KI_3_Iso</b>	Testing according to VDE. Class 3 device with isolated accessible conductive parts.	Insulation - S: 0.25 MΩ	 A1 1
12	<b>KI_3</b>	Testing according to VDE. Class 3 device without any isolated accessible conductive parts.		 A1 2

Pre-programmed autotest sequences table – welding machines









Autotest shortcut code - Welding machines		50	51	52	53	54
		KI1 Iso RisUmg	KI1 Iso NorUmg	KI1 Iso Schutz	KI1 ≤32A Risiko	KI1 ≤32A Normal
<b>Visual test</b>		<input checked="" type="checkbox"/>	<input checked="" type="checkbox"/>	<input checked="" type="checkbox"/>	<input checked="" type="checkbox"/>	<input checked="" type="checkbox"/>
<b>Rpe</b>	Output	200 mA	200 mA	200 mA	200 mA	200 mA
	Limit	0.30 Ω	0.30 Ω	0.30 Ω	0.30 Ω	0.30 Ω
	Time	5 s	5 s	5 s	5 s	5 s
<b>Insulation LN - PE</b>	Output	500 V	500 V	500 V	<input checked="" type="checkbox"/>	<input checked="" type="checkbox"/>
	Limit	2.50 MΩ	2.50 MΩ	2.50 MΩ	<input checked="" type="checkbox"/>	<input checked="" type="checkbox"/>
	Time	5 s	5 s	5 s	<input checked="" type="checkbox"/>	<input checked="" type="checkbox"/>
<b>Insulation W - PE</b>	Output	500 V	500 V	500 V	<input checked="" type="checkbox"/>	<input checked="" type="checkbox"/>
	Limit	2.50 MΩ	2.50 MΩ	2.50 MΩ	<input checked="" type="checkbox"/>	<input checked="" type="checkbox"/>
	Time	5 s	5 s	5 s	<input checked="" type="checkbox"/>	<input checked="" type="checkbox"/>
<b>Insulation LN - W</b>	Output	500 V	500 V	500 V	<input checked="" type="checkbox"/>	<input checked="" type="checkbox"/>
	Limit	5.00 MΩ	5.00 MΩ	5.00 MΩ	<input checked="" type="checkbox"/>	<input checked="" type="checkbox"/>
	Time	5 s	5 s	5 s	<input checked="" type="checkbox"/>	<input checked="" type="checkbox"/>
<b>Insulation LN - probe</b>	Output	<input checked="" type="checkbox"/>	<input checked="" type="checkbox"/>	<input checked="" type="checkbox"/>	<input checked="" type="checkbox"/>	<input checked="" type="checkbox"/>
	Limit	<input checked="" type="checkbox"/>	<input checked="" type="checkbox"/>	<input checked="" type="checkbox"/>	<input checked="" type="checkbox"/>	<input checked="" type="checkbox"/>
	Time	<input checked="" type="checkbox"/>	<input checked="" type="checkbox"/>	<input checked="" type="checkbox"/>	<input checked="" type="checkbox"/>	<input checked="" type="checkbox"/>
<b>Welding leakage</b>	Output	<input checked="" type="checkbox"/>	<input checked="" type="checkbox"/>	<input checked="" type="checkbox"/>	230 V	230 V
	Limit	<input checked="" type="checkbox"/>	<input checked="" type="checkbox"/>	<input checked="" type="checkbox"/>	10.00 mA	10.00 mA
	Time	<input checked="" type="checkbox"/>	<input checked="" type="checkbox"/>	<input checked="" type="checkbox"/>	5 s	5 s
<b>Differential leakage</b>	Output	<input checked="" type="checkbox"/>	<input checked="" type="checkbox"/>	<input checked="" type="checkbox"/>	230 V	230 V
	Limit	<input checked="" type="checkbox"/>	<input checked="" type="checkbox"/>	<input checked="" type="checkbox"/>	5.00 mA	5.00 mA
	Time	<input checked="" type="checkbox"/>	<input checked="" type="checkbox"/>	<input checked="" type="checkbox"/>	5 s	5 s
<b>Touch leakage</b>	Output	<input checked="" type="checkbox"/>	<input checked="" type="checkbox"/>	<input checked="" type="checkbox"/>	<input checked="" type="checkbox"/>	<input checked="" type="checkbox"/>
	Limit	<input checked="" type="checkbox"/>	<input checked="" type="checkbox"/>	<input checked="" type="checkbox"/>	<input checked="" type="checkbox"/>	<input checked="" type="checkbox"/>
	Time	<input checked="" type="checkbox"/>	<input checked="" type="checkbox"/>	<input checked="" type="checkbox"/>	<input checked="" type="checkbox"/>	<input checked="" type="checkbox"/>
<b>No load voltage</b>	Limit d.c.	113 Vpeak	113 Vpeak	141 Vpeak	113 Vpeak	113 Vpeak
	Limit a.c.	68 Vpeak 48 Vrms	113 Vpeak 80 Vrms	141 Vpeak 100 Vrms	68 Vpeak 48 Vrms	113 Vpeak 80 Vrms
<b>TRMS clamp current</b>	Output	<input checked="" type="checkbox"/>	<input checked="" type="checkbox"/>	<input checked="" type="checkbox"/>	<input checked="" type="checkbox"/>	<input checked="" type="checkbox"/>
	Limit	<input checked="" type="checkbox"/>	<input checked="" type="checkbox"/>	<input checked="" type="checkbox"/>	<input checked="" type="checkbox"/>	<input checked="" type="checkbox"/>
	Time	<input checked="" type="checkbox"/>	<input checked="" type="checkbox"/>	<input checked="" type="checkbox"/>	<input checked="" type="checkbox"/>	<input checked="" type="checkbox"/>
<b>Functional test</b>		<input checked="" type="checkbox"/>	<input checked="" type="checkbox"/>	<input checked="" type="checkbox"/>	<input checked="" type="checkbox"/>	<input checked="" type="checkbox"/>



## Pre-programmed autotest sequences table – welding machines (cont'd)

Autotest shortcut code Welding machines		55	56	57	58
		KI1_≤32A_Schutz	KI1_>32A_Risiko	KI1_>32A_Normal	KI1_>32A_Schutz
<b>Visual test</b>		<input checked="" type="checkbox"/>	<input checked="" type="checkbox"/>	<input checked="" type="checkbox"/>	<input checked="" type="checkbox"/>
<b>Rpe</b>	Output	200 mA	200 mA	200 mA	200 mA
	Limit	0.30 Ω	0.30 Ω	0.30 Ω	0.30 Ω
	Time	5 s	5 s	5 s	5 s
<b>Insulation LN - PE</b>	Output	<input checked="" type="checkbox"/>	<input checked="" type="checkbox"/>	<input checked="" type="checkbox"/>	<input checked="" type="checkbox"/>
	Limit	<input checked="" type="checkbox"/>	<input checked="" type="checkbox"/>	<input checked="" type="checkbox"/>	<input checked="" type="checkbox"/>
	Time	<input checked="" type="checkbox"/>	<input checked="" type="checkbox"/>	<input checked="" type="checkbox"/>	<input checked="" type="checkbox"/>
<b>Insulation W - PE</b>	Output	<input checked="" type="checkbox"/>	<input checked="" type="checkbox"/>	<input checked="" type="checkbox"/>	<input checked="" type="checkbox"/>
	Limit	<input checked="" type="checkbox"/>	<input checked="" type="checkbox"/>	<input checked="" type="checkbox"/>	<input checked="" type="checkbox"/>
	Time	<input checked="" type="checkbox"/>	<input checked="" type="checkbox"/>	<input checked="" type="checkbox"/>	<input checked="" type="checkbox"/>
<b>Insulation LN - W</b>	Output	<input checked="" type="checkbox"/>	<input checked="" type="checkbox"/>	<input checked="" type="checkbox"/>	<input checked="" type="checkbox"/>
	Limit	<input checked="" type="checkbox"/>	<input checked="" type="checkbox"/>	<input checked="" type="checkbox"/>	<input checked="" type="checkbox"/>
	Time	<input checked="" type="checkbox"/>	<input checked="" type="checkbox"/>	<input checked="" type="checkbox"/>	<input checked="" type="checkbox"/>
<b>Insulation LN - probe</b>	Output	<input checked="" type="checkbox"/>	<input checked="" type="checkbox"/>	<input checked="" type="checkbox"/>	<input checked="" type="checkbox"/>
	Limit	<input checked="" type="checkbox"/>	<input checked="" type="checkbox"/>	<input checked="" type="checkbox"/>	<input checked="" type="checkbox"/>
	Time	<input checked="" type="checkbox"/>	<input checked="" type="checkbox"/>	<input checked="" type="checkbox"/>	<input checked="" type="checkbox"/>
<b>Welding leakage</b>	Output	230 V	230 V	230 V	230 V
	Limit	10.00 mA	10.00 mA	10.00 mA	10.00 mA
	Time	5 s	5 s	5 s	5 s
<b>Differential leakage</b>	Output	230 V	230 V	230 V	230 V
	Limit	5.00 mA	10.00 mA	10.00 mA	10.00 mA
	Time	<input checked="" type="checkbox"/>	<input checked="" type="checkbox"/>	<input checked="" type="checkbox"/>	<input checked="" type="checkbox"/>
<b>Touch leakage</b>	Output	<input checked="" type="checkbox"/>	<input checked="" type="checkbox"/>	<input checked="" type="checkbox"/>	<input checked="" type="checkbox"/>
	Limit	<input checked="" type="checkbox"/>	<input checked="" type="checkbox"/>	<input checked="" type="checkbox"/>	<input checked="" type="checkbox"/>
	Time	<input checked="" type="checkbox"/>	<input checked="" type="checkbox"/>	<input checked="" type="checkbox"/>	<input checked="" type="checkbox"/>
<b>No load voltage</b>	Limit d.c.	141 Vpeak	113 Vpeak	113 Vpeak	141 Vpeak
	Limit a.c.	141 Vpeak 100 Vrms	68 Vpeak 48 Vrms	113 Vpeak 80 Vrms	141 Vpeak 100 Vrms
<b>TRMS clamp current</b>	Output	<input checked="" type="checkbox"/>	<input checked="" type="checkbox"/>	<input checked="" type="checkbox"/>	<input checked="" type="checkbox"/>
	Limit	<input checked="" type="checkbox"/>	<input checked="" type="checkbox"/>	<input checked="" type="checkbox"/>	<input checked="" type="checkbox"/>
	Time	<input checked="" type="checkbox"/>	<input checked="" type="checkbox"/>	<input checked="" type="checkbox"/>	<input checked="" type="checkbox"/>
<b>Functional test</b>		<input checked="" type="checkbox"/>	<input checked="" type="checkbox"/>	<input checked="" type="checkbox"/>	<input checked="" type="checkbox"/>

## Welding machines – Test type card

Code	Autotest sequence name and descriptions		Limits	Barcode
50	<b>KI1_Iso_RisUmg</b>	Class 1 device. Insulation resistance test is applicable. Environment with increased risk of electric shock.	Rpe: 0.30 $\Omega$ Ins LN-PE: 2.5 M $\Omega$ Ins W-PE: 2.5 M $\Omega$ Ins LN-W: 5.0 M $\Omega$ U <sub>0</sub> : d.c. 113 V <sub>p</sub> / a.c. 68 V <sub>p</sub> and 48 V <sub>rms</sub>	 A50
51	<b>KI1_Iso_NorUmg</b>	Class 1 device. Insulation resistance test is applicable. Environment without increased risk of electric shock.	Rpe: 0.30 $\Omega$ Ins LN-PE: 2.5 M $\Omega$ Ins W-PE: 2.5 M $\Omega$ Ins LN-W: 5.0 M $\Omega$ U <sub>0</sub> : d.c. 113 V <sub>p</sub> / a.c. 113 V <sub>p</sub> and 80 V <sub>rms</sub>	 A51
52	<b>KI1_Iso_Schutz</b>	Class 1 device. Insulation resistance test is applicable. Mechanically held torches with increased protection for the operator.	Rpe: 0.30 $\Omega$ Ins LN-PE: 2.5 M $\Omega$ Ins W-PE: 2.5 M $\Omega$ Ins LN-W: 5.0 M $\Omega$ U <sub>0</sub> : d.c. 141 V <sub>p</sub> / a.c. 141V <sub>p</sub> and 100 V <sub>rms</sub>	 A52
53	<b>KI1_≤32A_Risiko</b>	Class 1 device. Primary and welding circuit leakage current tests are applicable. Plug connected equipment rated ≤ 32 A. Environment with increased risk of electric shock.	Rpe: 0.30 $\Omega$ I leak-W: 10 mA I diff: 5 mA U <sub>0</sub> : d.c. 113 V <sub>p</sub> / a.c. 68 V <sub>p</sub> and 48 V <sub>rms</sub>	 A53
54	<b>KI1_≤32A_Normal</b>	Class 1 device. Primary and welding circuit leakage current tests are applicable. Plug connected equipment rated ≤32 A. Environment without increased risk of electric shock.	Rpe: 0.30 $\Omega$ I leak-W: 10 mA I diff: 5 mA U <sub>0</sub> : d.c. 113 V <sub>p</sub> / a.c. 113 V <sub>p</sub> and 80 V <sub>rms</sub>	 A54
55	<b>KI1_≤32A_Schutz</b>	Class 1 device. Primary and welding circuit leakage current tests are applicable. Plug connected equipment rated ≤ 32 A. Mechanically held torches with increased protection for the operator.	Rpe: 0.30 $\Omega$ I leak-W: 10 mA I diff: 5 mA U <sub>0</sub> : d.c. 141 V <sub>p</sub> / a.c. 141 V <sub>p</sub> and 100 V <sub>rms</sub>	 A55
56	<b>KI1_&gt;32A_Risiko</b>	Class 1 device. Primary and welding circuit leakage current tests are applicable. Plug connected equipment rated > 32 A or fixed installed equipment. Environment with increased risk of electric shock.	Rpe: 0.30 $\Omega$ I leak-W: 10 mA I diff: 10 mA U <sub>0</sub> : d.c. 113 V <sub>p</sub> / a.c. 68 V <sub>p</sub> and 48 V <sub>rms</sub>	 A56
57	<b>KI1_&gt;32A_Normal</b>	Class 1 device. Primary and welding circuit leakage current tests are applicable. Plug connected equipment rated > 32 A or fixed installed equipment. Environment without increased risk of electric shock.	Rpe: 0.30 $\Omega$ I leak-W: 10 mA I diff: 10 mA U <sub>0</sub> : d.c. 113 V <sub>p</sub> / a.c. 113 V <sub>p</sub> and 80 V <sub>rms</sub>	 A57
58	<b>KI1_&gt;32A_Schutz</b>	Class 1 device. Primary and welding circuit leakage current tests are applicable. Plug connected equipment rated > 32 A or fixed installed equipment. Mechanically held torches with increased protection for the operator.	Rpe: 0.30 $\Omega$ I leak-W: 10 mA I diff: 10 mA U <sub>0</sub> : d.c. 141 V <sub>p</sub> / a.c. 141V <sub>p</sub> and 100 V <sub>rms</sub>	 A58

## B Appendix B – Autotest shortcut codes

The instrument MultiservicerXA supports two barcode formats when printing device labels.

### Autotest shortcut code and DUT number

Autotest shortcut codes are represented as a two digit code. These autotest codes can also be represented by the barcode.

Using the barcode reader, the instruments can accept autotest shortcut code from barcode label.



01

Autotest shortcut code

Also DUT number can be read from barcode label.

### Single / double barcode system

If single barcode system is selected in the instrument, only DUT name is printed out as a barcode on device barcode label.

When double barcode system is selected in the instrument, both autotest shortcut code and DUT name are printed out as a barcode on DUT barcode label.

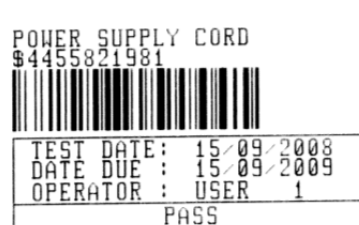
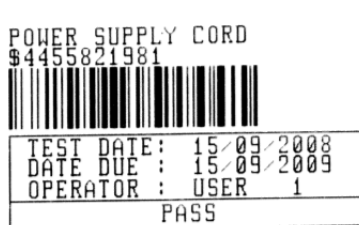
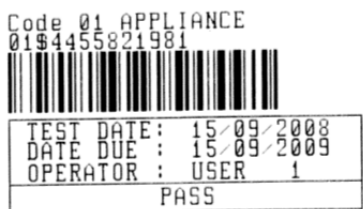
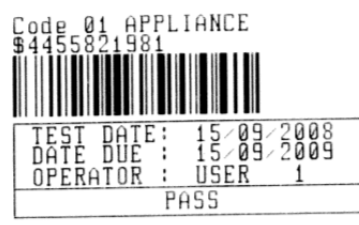
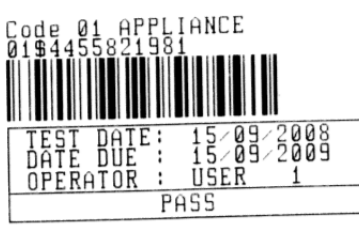
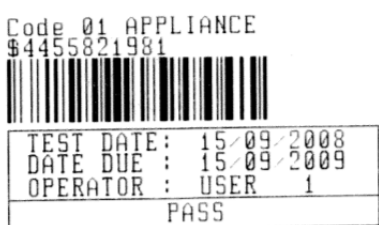

1 tag, barcode system:  
single (top label)  
1 tag, barcode system:  
double (bottom label)

2 tags, barcode system:  
double

2 tags, barcode system:  
single

Examples of DUT labels

01	Autotest shortcut code
\$	Separator
4455821981	DUT number

Refer to chapter 5.9.1 *Instrument settings* for barcode system selection.

**Notes:**

- Special character »\$« between autotest shortcut code and DUT name (ID number) is used to distinguish shortcut code from DUT name.
- Only DUT ID is printed out on the 2<sup>nd</sup> DUT label (power supply cord label).

## C Appendix C - Fuse table / I<sub>PSC</sub>

### Fuse type NV

Rated current (A)	Disconnection time [s]				
	35m	0.1	0.2	0.4	5
	Min. prospective short-circuit current (A)				
2	32.5	22.3	18.7	15.9	9.1
4	65.6	46.4	38.8	31.9	18.7
6	102.8	70	56.5	46.4	26.7
10	165.8	115.3	96.5	80.7	46.4
16	206.9	150.8	126.1	107.4	66.3
20	276.8	204.2	170.8	145.5	86.7
25	361.3	257.5	215.4	180.2	109.3
35	618.1	453.2	374	308.7	169.5
50	919.2	640	545	464.2	266.9
63	1217.2	821.7	663.3	545	319.1
80	1567.2	1133.1	964.9	836.5	447.9
100	2075.3	1429	1195.4	1018	585.4
125	2826.3	2006	1708.3	1454.8	765.1
160	3538.2	2485.1	2042.1	1678.1	947.9
200	4555.5	3488.5	2970.8	2529.9	1354.5
250	6032.4	4399.6	3615.3	2918.2	1590.6
315	7766.8	6066.6	4985.1	4096.4	2272.9
400	10577.7	7929.1	6632.9	5450.5	2766.1
500	13619	10933.5	8825.4	7515.7	3952.7
630	19619.3	14037.4	11534.9	9310.9	4985.1
710	19712.3	17766.9	14341.3	11996.9	6423.2
800	25260.3	20059.8	16192.1	13545.1	7252.1
1000	34402.1	23555.5	19356.3	16192.1	9146.2
1250	45555.1	36152.6	29182.1	24411.6	13070.1

### Fuse type gG

Rated current (A)	Disconnection time [s]				
	35m	0.1	0.2	0.4	5
	Min. prospective short-circuit current (A)				
2	32.5	22.3	18.7	15.9	9.1
4	65.6	46.4	38.8	31.9	18.7
6	102.8	70	56.5	46.4	26.7
10	165.8	115.3	96.5	80.7	46.4
13	193.1	144.8	117.9	100	56.2
16	206.9	150.8	126.1	107.4	66.3
20	276.8	204.2	170.8	145.5	86.7
25	361.3	257.5	215.4	180.2	109.3
32	539.1	361.5	307.9	271.7	159.1
35	618.1	453.2	374	308.7	169.5
40	694.2	464.2	381.4	319.1	190.1
50	919.2	640	545	464.2	266.9
63	1217.2	821.7	663.3	545	319.1
80	1567.2	1133.1	964.9	836.5	447.9
100	2075.3	1429	1195.4	1018	585.4

**Fuse type B**

Rated current (A)	Disconnection time [s]				
	35m	0.1	0.2	0.4	5
	<b>Min. prospective short-circuit current (A)</b>				
6	30	30	30	30	30
10	50	50	50	50	50
13	65	65	65	65	65
16	80	80	80	80	80
20	100	100	100	100	100
25	125	125	125	125	125
32	160	160	160	160	160
40	200	200	200	200	200
50	250	250	250	250	250
63	315	315	315	315	315

**Fuse type C**

Rated current (A)	Disconnection time [s]				
	35m	0.1	0.2	0.4	5
	<b>Min. prospective short-circuit current (A)</b>				
0.5	5	5	5	5	2.7
1	10	10	10	10	5.4
1.6	16	16	16	16	8.6
2	20	20	20	20	10.8
4	40	40	40	40	21.6
6	60	60	60	60	32.4
10	100	100	100	100	54
13	130	130	130	130	70.2
16	160	160	160	160	86.4
20	200	200	200	200	108
25	250	250	250	250	135
32	320	320	320	320	172.8
40	400	400	400	400	216
50	500	500	500	500	270
63	630	630	630	630	340.2

**Fuse type K**

Rated current (A)	Disconnection time [s]				
	35m	0.1	0.2	0.4	
	<b>Min. prospective short-circuit current (A)</b>				
0.5	7.5	7.5	7.5	7.5	
1	15	15	15	15	
1.6	24	24	24	24	
2	30	30	30	30	
4	60	60	60	60	
6	90	90	90	90	
10	150	150	150	150	
13	195	195	195	195	
16	240	240	240	240	
20	300	300	300	300	
25	375	375	375	375	
32	480	480	480	480	

**Fuse type D**

Rated current (A)	Disconnection time [s]				
	35m	0.1	0.2	0.4	5
	<b>Min. prospective short-circuit current (A)</b>				
0.5	10	10	10	10	2.7
1	20	20	20	20	5.4
1.6	32	32	32	32	8.6
2	40	40	40	40	10.8
4	80	80	80	80	21.6
6	120	120	120	120	32.4
10	200	200	200	200	54
13	260	260	260	260	70.2
16	320	320	320	320	86.4
20	400	400	400	400	108
25	500	500	500	500	135
32	640	640	640	640	172.8