



EurotestPV
MI 3108
Instruction manual
Version 1.4, Code no. 20 751 987

Distributor:

Manufacturer:

METREL d.d.
Ljubljanska cesta 77
1354 Horjul
Slovenia
web site: <http://www.metrel.si>
e-mail: metrel@metrel.si



Mark on your equipment certifies that this equipment meets the requirements of the EU (European Union) concerning safety and electromagnetic compatibility regulations

© 2013 METREL

The trade names Metrel, Smartec, Eurotest, Autosequence are trademarks registered or pending in Europe and other countries.

No part of this publication may be reproduced or utilized in any form or by any means without permission in writing from METREL.

Table of contents

1	Preface	6
2	Safety and operational considerations.....	7
2.1	Warnings and notes	7
2.2	Battery and charging	11
2.3	Standards applied	13
3	Instrument description.....	15
3.1	Front panel	15
3.2	Connector panel	16
3.3	Back side.....	17
3.4	Carrying the instrument.....	18
3.4.1	<i>Secure attachment of the strap</i>	19
3.5	Instrument set and accessories.....	20
3.5.1	<i>Standard set MI 3108</i>	20
3.5.2	<i>Optional accessories</i>	20
4	Instrument operation.....	21
4.1	Display and sound.....	21
4.1.1	<i>Terminal voltage monitor</i>	21
4.1.2	<i>Battery indication</i>	21
4.1.3	<i>Messages</i>	21
4.1.4	<i>Results</i>	22
4.1.5	<i>Sound warnings</i>	22
4.1.6	<i>Help screens</i>	22
4.1.7	<i>Backlight and contrast adjustments</i>	23
4.2	Function selection	23
4.3	Instruments main menu.....	25
4.4	Settings	25
4.4.1	<i>Memory</i>	26
4.4.2	<i>Language</i>	26
4.4.3	<i>Date and time</i>	26
4.4.4	<i>RCD standard</i>	27
4.4.5	<i>Isc factor</i>	28
4.4.6	<i>Commander support</i>	28
4.4.7	<i>Communication</i>	29
4.4.8	<i>Initial settings</i>	32
4.4.9	<i>Clamp Settings</i>	34
4.4.10	<i>Synchronization (A 1378 - PV Remote unit)</i>	35
4.4.11	<i>Solar settings</i>	36
5	Measurements – a.c. LV installations	39
5.1	Voltage, frequency and phase sequence	39
5.2	Insulation resistance.....	41
5.3	Resistance of earth connection and equipotential bonding	43
5.3.1	<i>R LOWΩ, 200 mA resistance measurement</i>	43
5.3.2	<i>Continuous resistance measurement with low current</i>	44
5.3.3	<i>Compensation of test leads resistance</i>	45
5.4	Testing RCDs.....	47
5.4.1	<i>Contact voltage (RCD Uc)</i>	48

5.4.2	Trip-out time (RCDt).....	49
5.4.3	Trip-out current (RCD I)	49
5.4.4	RCD Autotest	51
5.5	Fault loop impedance and prospective fault current	54
5.6	Line impedance and prospective short-circuit current / Voltage drop	56
5.6.1	Line impedance and prospective short circuit current.....	57
5.6.2	Voltage drop.....	58
5.7	Earth resistance	60
5.8	PE test terminal	62
6	Solar measurements - PV systems	64
6.1	Insulation resistance on PV systems	64
6.2	PV inverter test.....	66
6.3	PV panel test.....	70
6.4	Measuring of environmental parameters	72
6.4.1	Operation with A1378 PV Remote Unit	74
6.5	Uoc / Isc test.....	74
6.6	I / V curve measurement	76
7	Measurements - Power & Energy	78
7.1	Power	78
7.2	Harmonics	79
7.3	Scope	80
7.4	Current	81
7.5	Energy	82
8	Data handling.....	84
8.1	Memory organization	84
8.2	Data structure.....	84
8.3	Storing test results.....	86
8.4	Recalling test results	87
8.5	Clearing stored data	88
8.5.1	Clearing complete memory content	88
8.5.2	Clearing measurement(s) in selected location.....	88
8.5.3	Clearing individual measurements.....	89
8.5.4	Renaming installation structure elements (upload from PC).....	90
8.5.5	Renaming installation structure elements with serial barcode reader or RFID reader	90
8.6	Communication	91
8.6.1	USB and RS232 communication.....	91
8.6.2	Bluetooth communication.....	92
9	Upgrading the instrument.....	94
10	Maintenance	95
10.1	Fuse replacement.....	95
10.2	Cleaning	95
10.3	Periodic calibration	95
10.4	Service	95
11	Technical specifications.....	96
11.1	Insulation resistance, Insulation resistance of PV systems	96

11.2	Continuity	97
11.2.1	Resistance $R_{LOW\Omega}$	97
11.2.2	Resistance CONTINUITY	97
11.3	RCD testing	97
11.3.1	General data	97
11.3.2	Contact voltage RCD- U_c	98
11.3.3	Trip-out time	98
11.3.4	Trip-out current	98
11.4	Fault loop impedance and prospective fault current	99
11.4.1	No disconnecting device or FUSE selected	99
11.4.2	RCD selected	99
11.5	Line impedance and prospective short-circuit current / Voltage drop	100
11.6	Resistance to earth	101
11.7	Voltage, frequency, and phase rotation	101
11.7.1	Phase rotation	101
11.7.2	Voltage	101
11.7.3	Frequency	101
11.7.4	Online terminal voltage monitor	102
11.8	TRMS Clamp current	102
11.9	Power tests	103
11.10	PV tests	104
11.10.1	Accuracy of STC data	104
11.10.2	Panel, Inverter	104
11.10.3	I-V curve	105
11.10.4	U_{oc} - I_{sc}	105
11.10.5	Environmental parameters	106
11.10.6	Insulation Resistance of PV systems	106
11.11	General data	106
Appendix A – Fuse table		108
A.1	Fuse table – IPSC	108
A.2	Fuse table – Impedances at 230 V a.c. (AS/NZS 3017)	111
Appendix B – Accessories for specific measurements		112
Appendix C – Country notes		114
C.1	List of country modifications	114
C.2	Modification issues	114
C.2.1	AT modification - G type RCD	114
C.2.2	AUS / NZ modification – Fuse types according to AS/NZS 3017	115
Appendix D – Commanders (A 1314, A 1401)		118
D.1	 Warnings related to safety	118
D.2	Battery	118
D.3	Description of commanders	118
D.4	Operation of commanders	119
Appendix E – PV measurements - calculated values		121

1 Preface

Congratulations on your purchase of the Eurotest instrument and its accessories from METREL. The instrument was designed on a basis of rich experience, acquired through many years of dealing with electric installation test equipment.

The Eurotest instrument is a professional, multifunctional, hand-held test instrument intended to perform all the measurements on a.c. electrical LV installations and d.c. photovoltaic systems.

The following measurements and tests can be performed on a.c. electrical LV installations:

- Voltage and frequency,
- Continuity tests,
- Insulation resistance tests,
- RCD testing,
- Fault loop / RCD trip-lock impedance measurements,
- Line impedance / Voltage drop,
- Phase sequence,
- Earthing resistance tests,
- Current measurements,
- Power, harmonics and energy measurements.

Measurements and tests on PV systems:

- Voltages, currents and power in PV systems (Inverter and PV panels),
- Calculation of efficiencies and STC values in PV systems,
- Uoc / Isc measurements,
- Environmental parameters (Temperature and Irradiance),
- I-V curve test,
- Insulation resistance on PV systems.

The graphic display with backlight offers easy reading of results, indications, measurement parameters and messages. Two LED Pass/Fail indicators are placed at the sides of the LCD.

The operation of the instrument is designed to be as simple and clear as possible and no special training (except for the reading this instruction manual) is required in order to begin using the instrument.

In order for operator to be familiar enough with performing measurements in general and their typical applications it is advisable to read Metrel handbook *Guide for testing and verification of low voltage installations*.

The instrument is equipped with the entire necessary accessory for comfortable testing.

2 Safety and operational considerations

2.1 Warnings and notes

In order to maintain the highest level of operator safety while carrying out various tests and measurements, Metrel recommends keeping your Eurotest instruments in good condition and undamaged. When using the instrument, consider the following general warnings:



General warnings related to safety:

- ❑ The  symbol on the instrument means »Read the Instruction manual with special care for safe operation«. The symbol requires an action!
- ❑ If the test equipment is used in a manner not specified in this user manual, the protection provided by the equipment could be impaired!
- ❑ Read this user manual carefully, otherwise the use of the instrument may be dangerous for the operator, the instrument or for the equipment under test!
- ❑ Do not use the instrument or any of the accessories if any damage is noticed!
- ❑ Consider all generally known precautions in order to avoid risk of electric shock while dealing with hazardous voltages!
- ❑ If the 315 mA fuse blows follow the instructions in this manual in order to replace it! Use only fuses that are specified!
- ❑ Do not disassemble or repair the high breaking current fuse block! In case it fails the entire block must be replaced with a new original one!
- ❑ Do not use the instrument in AC supply systems with voltages higher than 550 Va.c.
- ❑ Service, repairs or adjustment of instruments and accessories is only allowed to be carried out by a competent authorized personnel!
- ❑ Use only standard or optional test accessories supplied by your distributor!
- ❑ Consider that protection category of some accessories is lower than of the instrument. Test tips and Tip commander have removable caps. If they are removed the protection falls to CAT II. Check markings on accessories!
(cap off, 18 mm tip)...CAT II up to 1000 V
(cap on, 4 mm tip)... CAT II 1000 V / CAT III 600 V / CAT IV 300 V
- ❑ The instrument comes supplied with rechargeable Ni-MH battery cells. The cells should only be replaced with the same type as defined on the battery compartment label or as described in this manual. Do not use standard alkaline battery cells while the power supply adapter is connected, otherwise they may explode!

- ❑ Hazardous voltages exist inside the instrument. Disconnect all test leads, remove the power supply cable and switch off the instrument before removing battery compartment cover.
- ❑ Do not connect any voltage source on C1 and P/C2 inputs. They are intended only for connection of current clamps and sensors. Maximal input voltage is 3 V!
- ❑ All normal safety precautions must be taken in order to avoid risk of electric shock while working on electrical installations!
- ❑ If the instrument is not in SOLAR operating mode the instrument displays a warning if an external DC voltage of higher than 50 V is applied to the instrument. Measurements are blocked. 



Warnings related to safety of measurement functions:

All PV functions

- ❑ Use only dedicated accessories for testing on PV electrical installations. Accessories for PV installations have yellow marked connectors.

Appropriate warnings are displayed. 

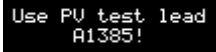
 Use PV test lead A1385!

PV Safety probe A1384 has inbuilt protective circuit that safely disconnects the instrument from the PV installation in case of a failure in the instrument.

PV test lead A1385 has integrated fuses that safely disconnects instrument from the PV installation in case of a failure in the instrument.

- ❑ Do not use the instrument in PV systems with voltages higher than 1000 V d.c. and/ or currents higher than 15 A d.c. ! Otherwise the instrument can be damaged.
- ❑ PV sources can produce very high voltages and currents. Only skilled and trained personnel should perform measurements on photovoltaic systems.
- ❑ Local regulations should be considered.
- ❑ Safety precautions for working on the roof should be considered.
- ❑ In case of a fault in the measuring system (wires, devices, connections, measuring instrument, accessories), presence of flammable gases, very high moisture or heavy dust an electrical arc can occur that will not extinguish by itself. Arcs can lead to fire and can cause heavy damage. Users must be skilled to disconnect the PV system safely in this case.

Insulation resistance, Insulation resistance of PV systems

- ❑ Insulation resistance measurement should only be performed on de-energized objects!
- ❑ Do not touch the test object during the measurement or before it is fully discharged! Risk of electric shock!
- ❑ When an insulation resistance measurement has been performed on a capacitive object, automatic discharge may not be done immediately! The warning message  and the actual voltage are displayed during discharge until voltage drops below 10 V.

Continuity functions

- Continuity measurements should only be performed on de-energized objects!
- Parallel loops may influence on test results.



Testing PE terminal

- If phase voltage is detected on the tested PE terminal, stop all measurements immediately and ensure the cause of the fault is eliminated before proceeding with any activity!

Notes related to measurement functions:**General**

- The  indicator means that the selected measurement cannot be performed because of irregular conditions on input terminals.
- Insulation resistance, continuity functions and earth resistance measurements can only be performed on de-energized objects.
- PASS / FAIL indication is enabled when limit is set. Apply appropriate limit value for evaluation of measurement results.
- In the case that only two of the three wires are connected to the electrical installation under test, only voltage indication between these two wires is valid.

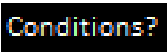
Insulation resistance, Insulation resistance of PV systems

- **Insulation resistance:**
If a voltage of higher than 30 V (AC or DC) is detected between test terminals, the insulation resistance measurement will not be performed.
- **Insulation resistance of PV systems:**
Different pre-tests are carried out. If conditions are proper and safe the measurement will be continued.
Otherwise  or  or  message is displayed.
- The instrument automatically discharge tested object after finished measurement.
- A double click of TEST key starts a continuous measurement.

Continuity functions

- If a voltage of higher than 10 V (AC or DC) is detected between test terminals, the continuity resistance test will not be performed.
- Compensate test lead resistance before performing a continuity measurement, where necessary.

RCD functions

- Parameters set in one function are also kept for other RCD functions!
- The measurement of contact voltage does not normally trip an RCD. However, the trip limit of the RCD may be exceeded as a result of leakage current flowing to the PE protective conductor or a capacitive connection between L and PE conductors.

- ❑ The RCD trip-lock sub-function (function selector switch in LOOP position) takes longer to complete but offers much better accuracy of fault loop resistance (in comparison to the R_L sub-result in Contact voltage function).
- ❑ RCD trip-out time and RCD trip-out current measurements will only be performed if the contact voltage in the pre-test at nominal differential current is lower than the set contact voltage limit!
- ❑ The autotest sequence (RCD AUTO function) stops when trip-out time is out of allowable time period.

Z-LOOP

- ❑ The low limit prospective short-circuit current value depends on fuse type, fuse current rating, fuse trip-out time and impedance scaling factor.
- ❑ The specified accuracy of tested parameters is valid only if the mains voltage is stable during the measurement.
- ❑ Fault loop impedance measurements will trip an RCD.
- ❑ The measurement of fault loop impedance using trip-lock function does not normally trip an RCD. However, the trip limit may be exceeded if a leakage current flows to the PE protective conductor or if there is a capacitive connection between L and PE conductors.

Z-LINE / Voltage drop

- ❑ In case of measurement of $Z_{\text{Line-Line}}$ with the instrument test leads PE and N connected together the instrument will display a warning of dangerous PE voltage. The measurement will be performed anyway.
- ❑ Specified accuracy of tested parameters is valid only if mains voltage is stable during the measurement.
- ❑ L and N test terminals are reversed automatically according to detected terminal voltage (except in UK version).

Power / Harmonics / Energy / Current

- ❑ Before starting any Power measurement the current clamp settings in Settings menu should be checked. Select appropriate current clamp model and measuring range that are best fitted to the expected current values.
- ❑ Consider polarity of current clamp (arrow on test clamp should be oriented toward connected load), otherwise result will be negative!

PV measurements

- ❑ A 1384 PV Safety Probe **must be used** for PANEL, UOC/ISC, I/V, INVERTER (AC, DC) and ISO PV measurements.
- ❑ A 1385 PV test lead **must be used** for INVERTER AC/DC measurements.
- ❑ Before starting a PV measurement the settings of PV module type and PV test parameters should be checked.
- ❑ Environmental parameters (I_{rr} , T) can be measured or entered manually.
- ❑ Environmental conditions (irradiance, temperature) must be stable during the measurements.
- ❑ For calculation of STC results measured U_{oc} / I_{sc} values, irradiance, temperature (ambient or cell), and PV module parameters must be known. Refer to Appendix E for more information.
- ❑ Always perform zeroing of DC current clamps before test.

2.2 Battery and charging

The instrument uses six AA size alkaline or rechargeable Ni-MH battery cells. Nominal operating time is declared for cells with nominal capacity of 2100 mAh. Battery condition is always displayed in the lower right display part. In case the battery is too weak the instrument indicates this as shown in figure 2.1. This indication appears for a few seconds and then the instrument turns itself off.

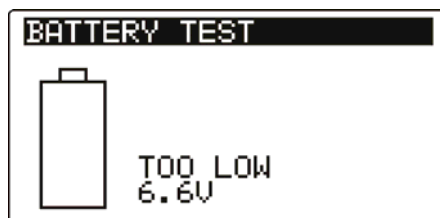

Figure 2.1: Discharged battery indication

The battery is charged whenever the power supply adapter is connected to the instrument. The power supply socket polarity is shown in figure 2.2. Internal circuit controls charging and assures maximum battery lifetime.



Figure 2.2: Power supply socket polarity

Symbols:

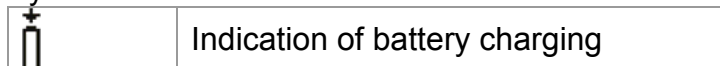

Figure 2.3: Charging indication



Warnings related to safety:

- ❑ When connected to an installation, the instruments battery compartment can contain hazardous voltage inside! When replacing battery cells or before opening the battery/fuse compartment cover, disconnect any measuring accessory connected to the instrument and turn off the instrument,
- ❑ Ensure that the battery cells are inserted correctly otherwise the instrument will not operate and the batteries could be discharged.
- ❑ Do not recharge alkaline battery cells!
- ❑ Use only power supply adapter delivered from the manufacturer or distributor of the test equipment!

Notes:

- ❑ The charger in the instrument is a pack cell charger. This means that the battery cells are connected in series during the charging. The battery cells have to be equivalent (same charge condition, same type and age).

- ❑ If the instrument is not to be used for a long period of time, remove all batteries from the battery compartment.
- ❑ Alkaline or rechargeable Ni-MH batteries (size AA) can be used. Metrel recommends only using rechargeable batteries with a capacity of 2100mAh or above.
- ❑ Unpredictable chemical processes can occur during the charging of battery cells that have been left unused for a longer period (more than 6 months). In this case Metrel recommends to repeat the charge / discharge cycle at least 2-4 times.
- ❑ If no improvement is achieved after several charge / discharge cycles, then each battery cell should be checked (by comparing battery voltages, testing them in a cell charger, etc). It is very likely that only some of the battery cells are deteriorated. One different battery cell can cause an improper behavior of the entire battery pack!
- ❑ The effects described above should not be confused with the normal decrease of battery capacity over time. Battery also loses some capacity when it is repeatedly charged / discharged. This information is provided in the technical specification from battery manufacturer.

2.3 Standards applied

The Eurotest instruments are manufactured and tested in accordance with the following regulations:

Electromagnetic compatibility (EMC)

EN 61326	Electrical equipment for measurement, control and laboratory use – EMC requirements Class B (Hand-held equipment used in controlled EM environments)
----------	---

Safety (LVD)

EN 61010-1	Safety requirements for electrical equipment for measurement, control and laboratory use – Part 1: General requirements
EN 61010-2-030	Safety requirements for electrical equipment for measurement, control and laboratory use – Part 2-030: Particular requirements for testing and measuring circuits
EN 61010-031	Safety requirements for electrical equipment for measurement, control and laboratory use – Part 031: Safety requirements for hand-held probe assemblies for electrical measurement and test
EN 61010-2-032	Safety requirements for electrical equipment for measurement, control, and laboratory use - Part 2-032: Particular requirements for hand-held and hand-manipulated current sensors for electrical test and measurement

Functionality

EN 61557	Electrical safety in low voltage distribution systems up to 1000 V _{AC} and 1500 V _{AC} – Equipment for testing, measuring or monitoring of protective measures Part 1 General requirements Part 2 Insulation resistance Part 3 Loop resistance Part 4 Resistance of earth connection and equipotential bonding Part 5 Resistance to earth Part 6 Residual current devices (RCDs) in TT and TN systems Part 7. Phase sequence Part 10 Combined measuring equipment Part 12 Performance measuring and monitoring devices (PMD)
----------	--

Reference standards for electrical installations and components

EN 61008	Residual current operated circuit-breakers without integral overcurrent protection for household and similar uses
EN 61009	Residual current operated circuit-breakers with integral overcurrent protection for household and similar uses
IEC 60364-4-41	Electrical installations of buildings Part 4-41 Protection for safety – protection against electric shock
BS 7671	IEE Wiring Regulations (17 th edition)
AS/NZS 3017	Electrical installations – Verification guidelines

Reference standard for photovoltaic systems

EN 62446	Grid connected photovoltaic systems – Minimum requirements for system documentation, commissioning tests and inspection
----------	---

Note about EN and IEC standards:

- Text of this manual contains references to European standards. All standards of EN 6XXXX (e.g. EN 61010) series are equivalent to IEC standards with the same number (e.g. IEC 61010) and differ only in amended parts required by European harmonization procedure.

3 Instrument description

3.1 Front panel

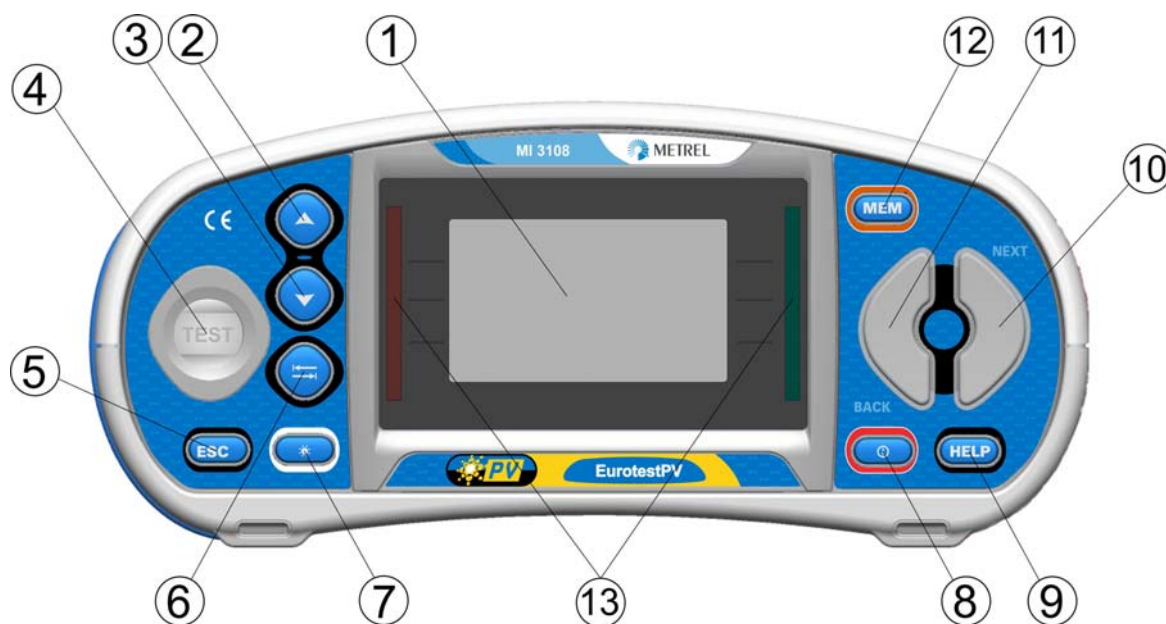

Figure 3.1: Front panel

Legend:

1	LCD	128 x 64 dots matrix display with backlight.
2	UP	Modifies selected parameter.
3	DOWN	
4	TEST	TEST Starts measurements. Acts also as the PE touching electrode.
5	ESC	Goes one level back.
6	TAB	Selects the parameters in selected function.
7	Backlight, Contrast	Changes backlight level and contrast.
8	ON / OFF	Switches the instrument power on or off. <i>The instrument automatically turns off 15 minutes after the last key was pressed</i>
9	HELP / CAL	Accesses help menus. Calibrates test leads in Continuity functions. Starts Z_{REF} measurement in Voltage drop sub-function.
10	Function selector - RIGHT	Selects test function.
11	Function selector - LEFT	
12	MEM	Stores / recalls memory of instrument. Stores clamp and solar settings.
13	Green LEDs Red LEDs	Indicates PASS / FAIL of result.

3.2 Connector panel

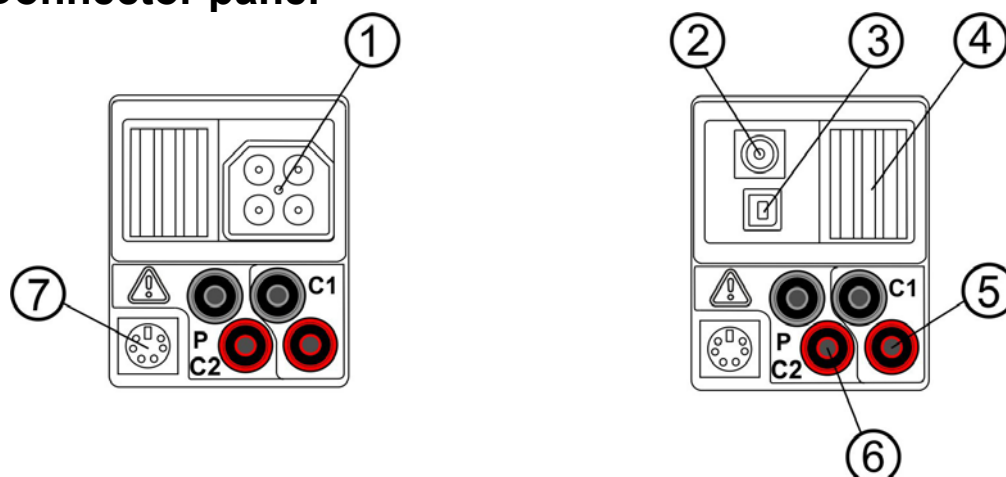

Figure 3.2: Connector panel (picture of MI 3108)

Legend:

1	Test connector	Measuring inputs / outputs
2	Charger socket	
3	USB connector	Communication with PC USB (1.1) port.
4	Protection cover	
5	C1	Current clamp measuring input #1
6	P/C2	Current clamp measuring input #2 Measuring input for external probes
7	PS/2 connector	Communication with PC serial port Connection to optional measuring adapters Connection to barcode / RFID reader Connection to Bluetooth dongle

Warnings!

- ❑ **Maximum allowed voltage between any test terminal and ground is 600 V a.c., 1000 V d.c.!**
- ❑ **Maximum allowed voltage between test terminals on test connector is 600 V a.c., 1000 V d.c.!**
- ❑ **Maximum allowed voltage between test terminals P/C2, C1 is 3 V!**
- ❑ **Maximum short-term voltage of external power supply adapter is 14 V!**

3.3 Back side

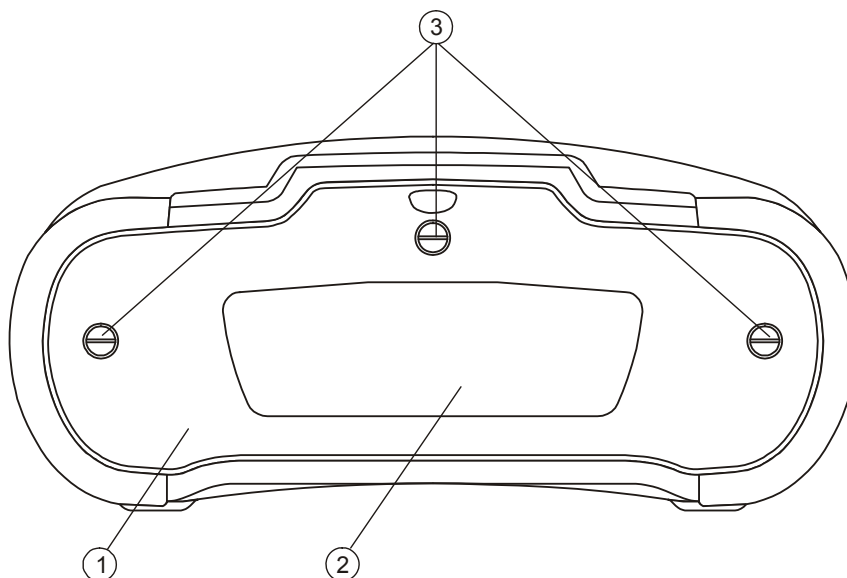

Figure 3.3: Back panel

Legend:

- | | |
|---|--|
| 1 | Battery / fuse compartment cover |
| 2 | Back panel information label |
| 3 | Fixing screws for battery / fuse compartment cover |

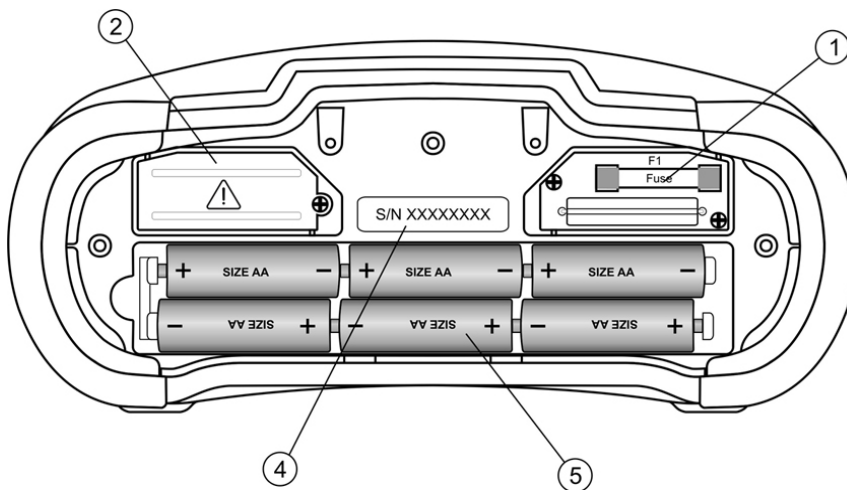

Figure 3.4: Battery and fuse compartment

Legend:

- | | | |
|---|----------------------------------|---|
| 1 | Fuse F1 | FF 315 mA / 1000 V d.c.
(Breaking capacity: 50 kA) |
| 2 | High breaking current fuse block | |
| 3 | Serial number label | |
| 4 | Battery cells | Size AA, alkaline / rechargeable NiMH |
| 5 | Battery holder | Can be removed from the instrument |

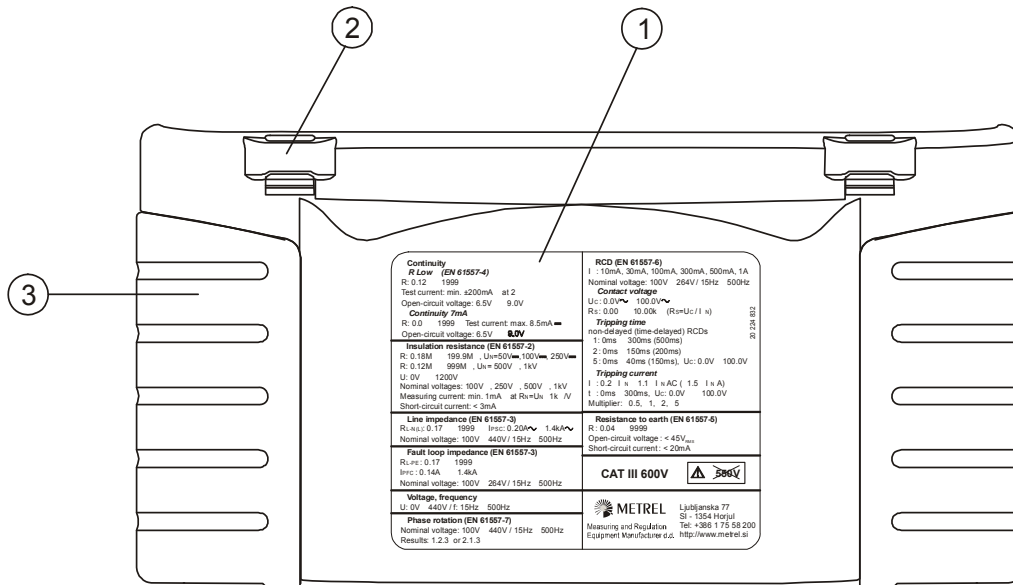

Figure 3.5: Bottom

Legend:

- 1 Bottom information label
- 2 Neck belt openings
- 3 Handling side covers

3.4 Carrying the instrument

With the neck-carrying belt supplied in standard set, various possibilities of carrying the instrument are available. Operator can choose appropriate one on basis of his operation, see the following examples:





The instrument can be used even when placed in soft carrying bag – test cable connected to the instrument through the front aperture.

3.4.1 Secure attachment of the strap

You can choose between two methods:

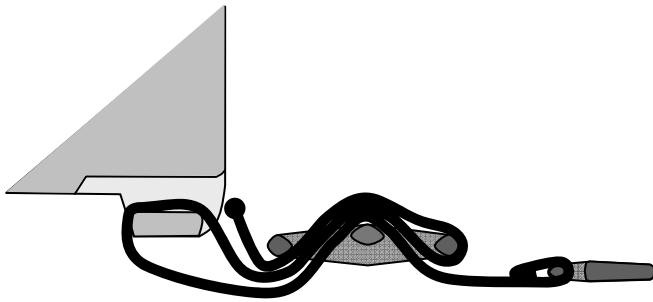

Figure 3.6: First method

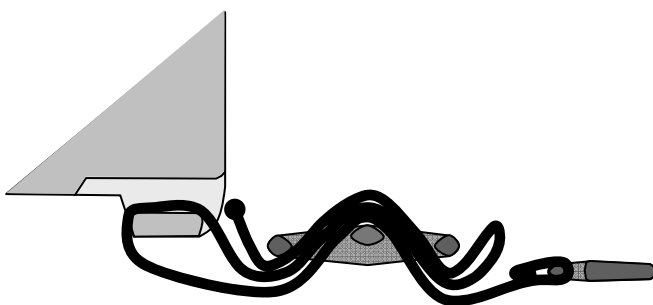

Figure 3.7: Alternative method

Please perform a periodical check of the attachment.

3.5 Instrument set and accessories

3.5.1 Standard set MI 3108

- ❑ Instrument
- ❑ Soft carrying bag, 2 pcs
- ❑ PV Safety Probe
- ❑ Pyranometer
- ❑ PV Temperature probe
- ❑ AC/ DC current clamp
- ❑ Schuko-plug test cable
- ❑ Test lead, 3 x 1.5 m
- ❑ Test probe, 4 pcs
- ❑ Crocodile clip, 4 pcs
- ❑ Set of carrying straps
- ❑ PV MC 4 adapter male
- ❑ PV MC 4 adapter female
- ❑ PV MC 3 adapter male
- ❑ PV MC 3 adapter female
- ❑ RS232-PS/2 cable
- ❑ USB cable
- ❑ Set of NiMH battery cells
- ❑ Power supply adapter
- ❑ CD with instruction manual, and “Guide for testing and verification of low voltage installations” handbook.
- ❑ Short instruction manual
- ❑ Calibration Certificate

3.5.2 Optional accessories

See the attached sheet for a list of optional accessories that are available on request from your distributor.

4 Instrument operation

4.1 Display and sound

4.1.1 Terminal voltage monitor

The terminal voltage monitor displays on-line the voltages on the test terminals and information about active test terminals in the a.c. installation measuring mode.

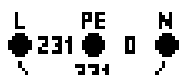

Online voltages are displayed together with test terminal indication. All three test terminals are used for selected measurement.

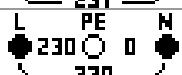

Online voltages are displayed together with test terminal indication. L and N test terminals are used for selected measurement.



L and PE are active test terminals; N terminal should also be connected for correct input voltage condition.

4.1.2 Battery indication

The battery indication indicates the charge condition of battery and connection of external charger.



Battery capacity indication.



Low battery.

Battery is too weak to guarantee correct result. Replace or recharge the battery cells.



Charging in progress (if power supply adapter is connected).

4.1.3 Messages

In the message field warnings and messages are displayed.



Measurement is running, consider displayed warnings.



Conditions on the input terminals allow starting the measurement; consider other displayed warnings and messages.



Conditions on the input terminals do not allow starting the measurement, consider displayed warnings and messages.



RCD tripped-out during the measurement (in RCD functions).













Instrument is overheated. The measurement is prohibited until the temperature decreases under the allowed limit.





Result(s) can be stored.



High electrical noise was detected during measurement. Results may be impaired.

	L and N are changed.
	Warning! High voltage is applied to the test terminals.
	Warning! Dangerous voltage on the PE terminal! Stop the activity immediately and eliminate the fault / connection problem before proceeding with any activity!
	Test leads resistance in Continuity measurement is not compensated.
	Test leads resistance in Continuity measurement is compensated.
	High resistance to earth of test probes. Results may be impaired.
	Too small current for declared accuracy. Results may be impaired. Check in Current Clamp Settings if sensitivity of current clamp can be increased.
	Measured signal is out of range (clipped). Results are impaired.
	Fuse F1 is broken.
	External DC voltage is detected. Measurements in this operating mode are blocked.

4.1.4 Results

	Measurement result is inside pre-set limits (PASS).
	Measurement result is out of pre-set limits (FAIL).
	Measurement is aborted. Consider displayed warnings and messages.

4.1.5 Sound warnings

Continuous sound **Warning!** Dangerous voltage on the PE terminal is detected.

4.1.6 Help screens

HELP	Opens help screen.
-------------	--------------------

Help menus are available in all functions. The Help menu contains schematic diagrams for illustrating how to properly connect the instrument to electric installation or PV system. After selecting the measurement you want to perform, press the HELP key in order to view the associated Help menu.

Keys in help menu:

UP / DOWN	Selects next / previous help screen.
ESC / HELP / Function selector	Exits help menu.

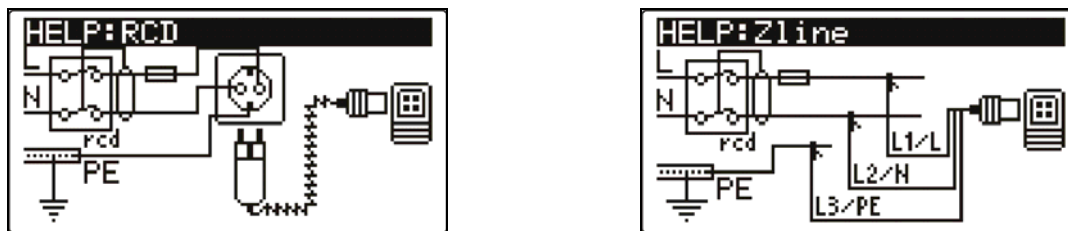

Figure 4.1: Examples of help screens

4.1.7 Backlight and contrast adjustments

With the **BACKLIGHT** key backlight and contrast can be adjusted.

Click	Toggles backlight intensity level.
Keep pressed for 1 s	Locks high intensity backlight level until power is turned off or the key is pressed again.
Keep pressed for 2 s	Bargraph for LCD contrast adjustment is displayed.

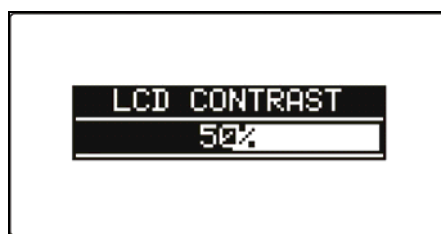

Figure 4.2: Contrast adjustment menu

Keys for contrast adjustment:

DOWN	Reduces contrast.
UP	Increases contrast.
TEST	Accepts new contrast.
ESC	Exits without changes.

4.2 Function selection

For selecting test / measurement function within each test mode the **FUNCTION SELECTOR** keys shall be used.

Keys:

Function selector	Selects test / measurement function.
UP/DOWN	Selects sub-function in selected measurement function. Selects screen to be viewed (if results are split into more screens).
TAB	Selects the test parameter to be set or modified.
TEST	Runs selected test / measurement function.
MEM	Stores measured results / recalls stored results.
ESC	Exits back to main menu.

Keys in **test parameter** field:

UP/DOWN	Changes the selected parameter.
TAB	Selects the next measuring parameter.
Function selector	Toggles between the main functions.
MEM	Stores measured results / recalls stored results

General rule regarding enabling **parameters** for evaluation of measurement / test result:

Parameter	OFF	No limit values, indication: <u> </u> .
	ON	Value(s) – results will be marked as PASS or FAIL in accordance with selected limit.

See *Chapter 5* for more information about the operation of the instrument test functions.

4.3 Instruments main menu

In instrument's main menu the test mode can be selected. Different instrument options can be set in the **SETTINGS** menu.

- ❑ <**INSTALLATION**> a.c. LV installation testing
- ❑ <**POWER**> Power & Energy testing
- ❑ <**SOLAR**> PV systems testing
- ❑ <**SETTINGS**> Instrument settings

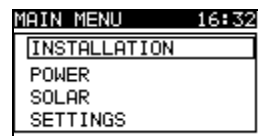

Figure 4.3: Main menu

Keys:

UP / DOWN	Selects appropriate option.
TEST	Enters selected option.

4.4 Settings

Different instrument options can be set in the **SETTINGS** menu.

Options are:

- ❑ Recalling and clearing stored results
- ❑ Selection of language
- ❑ Setting the date and time
- ❑ Selection of reference standard for RCD tests
- ❑ Entering Isc factor
- ❑ Commander support
- ❑ Setting the instrument to initial values
- ❑ Settings for Bluetooth communication
- ❑ Settings for current clamps
- ❑ Menu for synchronization with PV Remote unit
- ❑ Settings for PV measurements

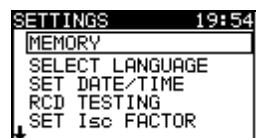

Figure 4.4: Options in Settings menu

Keys:

UP / DOWN	Selects appropriate option.
TEST	Enters selected option.
ESC / Function selector	Exits back to main menu.

4.4.1 Memory

In this menu the stored data can be recalled or deleted. See chapter 8 *Data handling* for more information.

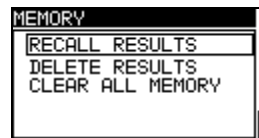

Figure 4.5: Memory options

Keys:

UP / DOWN	Selects option.
TEST	Enters selected option.
ESC	Exits back to Settings menu.
Function selector	Exits back to main menu without changes.

4.4.2 Language

In this menu the language can be set.



Figure 4.6: Language selection

Keys:

UP / DOWN	Selects language.
TEST	Confirms selected language and exits to settings menu.
ESC	Exits back to Settings menu.
Function selector	Exits back to main menu without changes.

4.4.3 Date and time

In this menu date and time can be set.



Figure 4.7: Setting date and time

Keys:

TAB	Selects the field to be changed.
UP / DOWN	Modifies selected field.
TEST	Confirms new date / time and exits.
ESC	Exits back to Settings menu.
Function selector	Exits back to main menu without changes.

Warning:

- If the batteries are removed for more than 1 minute the set date and time will be lost.

4.4.4 RCD standard

In this menu the used standard for RCD tests can be set.

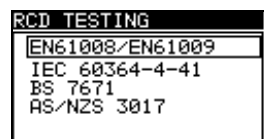

Figure 4.8: Selection of RCD test standard

Keys:

UP / DOWN	Selects standard.
TEST	Confirms selected standard.
ESC	Exits back to Settings menu.
Function selector	Exits back to main menu without changes.

Maximum RCD disconnection times differ in various standards. The trip-out times defined in individual standards are listed below.

Trip-out times according to EN 61008 / EN 61009:

	$\frac{1}{2} \times I_{\Delta N}^{*)}$	$I_{\Delta N}$	$2 \times I_{\Delta N}$	$5 \times I_{\Delta N}$
General RCDs (non-delayed)	$t_{\Delta} > 300$ ms	$t_{\Delta} < 300$ ms	$t_{\Delta} < 150$ ms	$t_{\Delta} < 40$ ms
Selective RCDs (time-delayed)	$t_{\Delta} > 500$ ms	130 ms $< t_{\Delta} < 500$ ms	60 ms $< t_{\Delta} < 200$ ms	50 ms $< t_{\Delta} < 150$ ms

Trip-out times according to IEC 60364-4-41:

	$\frac{1}{2} \times I_{\Delta N}^{*)}$	$I_{\Delta N}$	$2 \times I_{\Delta N}$	$5 \times I_{\Delta N}$
General RCDs (non-delayed)	$t_{\Delta} > 999$ ms	$t_{\Delta} < 999$ ms	$t_{\Delta} < 150$ ms	$t_{\Delta} < 40$ ms
Selective RCDs (time-delayed)	$t_{\Delta} > 999$ ms	130 ms $< t_{\Delta} < 999$ ms	60 ms $< t_{\Delta} < 200$ ms	50 ms $< t_{\Delta} < 150$ ms

Trip-out times according to BS 7671:

	$\frac{1}{2} \times I_{\Delta N}^{*)}$	$I_{\Delta N}$	$2 \times I_{\Delta N}$	$5 \times I_{\Delta N}$
General RCDs (non-delayed)	$t_{\Delta} > 1999$ ms	$t_{\Delta} < 300$ ms	$t_{\Delta} < 150$ ms	$t_{\Delta} < 40$ ms
Selective RCDs (time-delayed)	$t_{\Delta} > 1999$ ms	130 ms $< t_{\Delta} < 500$ ms	60 ms $< t_{\Delta} < 200$ ms	50 ms $< t_{\Delta} < 150$ ms

Trip-out times according to AS/NZS 3017^{**) :}

RCD type	$I_{\Delta N}$ [mA]	$\frac{1}{2} \times I_{\Delta N}^{*)}$ t_{Δ}	$I_{\Delta N}$ t_{Δ}	$2 \times I_{\Delta N}$ t_{Δ}	$5 \times I_{\Delta N}$ t_{Δ}	Note
I	≤ 10	> 999 ms	40 ms	40 ms	40 ms	Maximum break time
II	$> 10 \leq 30$		300 ms	150 ms	40 ms	
III	> 30		300 ms	150 ms	40 ms	
IV	> 30	> 999 ms	500 ms	200 ms	150 ms	Minimum non-actuating time
			130 ms	60 ms	50 ms	

^{*)} Minimum test period for current of $\frac{1}{2} \times I_{\Delta N}$, RCD shall not trip-out.

^{**)} Test current and measurement accuracy correspond to AS/NZS 3017 requirements.

Maximum test times related to selected test current for general (non-delayed) RCD

Standard	$\frac{1}{2} \times I_{\Delta N}$	$I_{\Delta N}$	$2 \times I_{\Delta N}$	$5 \times I_{\Delta N}$
EN 61008 / EN 61009	300 ms	300 ms	150 ms	40 ms
IEC 60364-4-41	1000 ms	1000 ms	150 ms	40 ms
BS 7671	2000 ms	300 ms	150 ms	40 ms
AS/NZS 3017 (I, II, III)	1000 ms	1000 ms	150 ms	40 ms

Maximum test times related to selected test current for selective (time-delayed) RCD

Standard	$\frac{1}{2} \times I_{\Delta N}$	$I_{\Delta N}$	$2 \times I_{\Delta N}$	$5 \times I_{\Delta N}$
EN 61008 / EN 61009	500 ms	500 ms	200 ms	150 ms
IEC 60364-4-41	1000 ms	1000 ms	200 ms	150 ms
BS 7671	2000 ms	500 ms	200 ms	150 ms
AS/NZS 3017 (IV)	1000 ms	1000 ms	200 ms	150 ms

4.4.5 I_{sc} factor

In this menu the I_{sc} factor for calculation of short circuit current in Z-LINE and Z-LOOP measurements can be set.

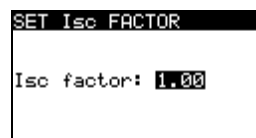

Figure 4.9: Selection of I_{sc} factor

Keys:

UP / DOWN	Sets I _{sc} value.
TEST	Confirms I _{sc} value.
ESC	Exits back to Settings menu.
Function selectors	Exits back to main menu without changes.

Short circuit current I_{sc} in the supply system is important for selection or verification of protective circuit breakers (fuses, over-current breaking devices, RCDs). The default value of I_{sc} factor (k_{sc}) is 1.00. The value should be set according to local regulative.

Range for adjustment of the I_{sc} factor is 0.20 ÷ 3.00.

4.4.6 Commander support

The support for remote commanders can be enabled or disabled in this menu.

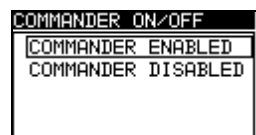

Figure 4.10: Selection of commander support

Keys:

UP / DOWN	Selects commander option.
TEST	Confirms selected option.
ESC	Exits back to Settings menu.
Function selector	Exits back to main menu without changes.

Note:

- Commander disabled option is intended to disable the commander’s remote keys. In the case of high EM interfering noise the operation of the commander can be irregular.

4.4.7 Communication

In this menu the instrument’s serial communication port can be configured and Bluetooth dongles A 1436 can be initialized.

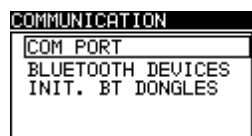

Figure 4.11: Communication menu

Options:

COM PORT	Enters menu for setting serial communication.
BLUETOOTH DEVICES	Enters menu for viewing and selecting Bluetooth devices.
INIT. BT DONGLES	Enters menu for initialization of Bluetooth dongle(s).

Keys:

UP / DOWN	Selects option.
TEST	Confirms selected option.
ESC	Exits back to Settings menu.
Function selector	Exits back to main menu without changes.

4.4.7.1 Selecting serial communication

In the COM PORT menu the serial communication can be set (wired, Bluetooth or wireless).

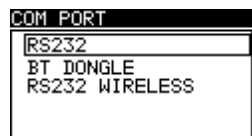

Figure 4.122: Menu for serial communication

Options:

COM PORT	RS232	Communication with external devices via RS232 cable.
	BT DONGLE	Communication with mobile devices, Metrel Powermeters, PCs or other external devices via Bluetooth.

	RS232 WIRELESS	Wireless communication with external devices (A 1378 PV remote unit).
--	----------------	---

Keys:

UP / DOWN	Selects option.
TEST	Confirms selected option.
ESC	Exits back to Settings menu.
Function selector	Exits back to main menu without changes.

4.4.7.2 Searching for the Metrel Powermeter with Bluetooth connection and pairing with EurotestPV instrument

In the BLUETOOTH DEVICES menu a Metrel Powermeter with Bluetooth connection can be found, selected and paired with the instrument. The Metrel Powermeter must have connected a properly initialized Bluetooth dongle A 1436. See chapter *Initialization of the Bluetooth dongle(s)* for more details.

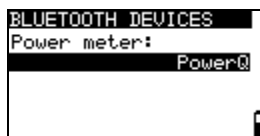

Figure 4.133: Bluetooth devices menu

To select a new Powermeter with Bluetooth connection press TEST in BLUETOOTH DEVICES menu. A list of found Bluetooth devices will be displayed. Select the appropriate device using the arrow keys. Confirmation with TEST key will pair those two instruments.

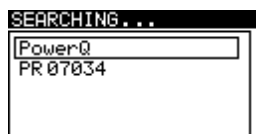

Figure 4.144: Searching and selection of Metrel Powermeter Bluetooth connection

Keys:

UP / DOWN	Selects appropriate Bluetooth device.
TEST	Confirms selected device.
ESC	Exits back to Bluetooth devices menu.
Function selector	Exits back to main menu without changes.

Note:

- This operation must be performed when using Bluetooth communication with the Powermeter for the first time or if its settings were changed.

4.4.7.3 Initialization of the Bluetooth dongle(s)

The Bluetooth dongle(s) A 1436 should be initialized when they are used for the first time. During initialization the instrument sets the dongle parameters and name in order to communicate properly.

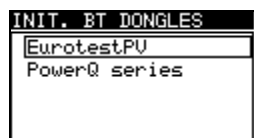

Figure 4.155: Menu for initialization of Bluetooth dongle(s)

INIT. BT DONGLES	EurotestPV	<i>Initializes Bluetooth dongle for EurotestPV instrument.</i>
	PowerQ series	<i>Initializes Bluetooth dongle for Metrel Powermeter.</i>

Keys:

UP / DOWN	Selects option.
TEST	Starts initialization of Bluetooth dongle.
ESC	Exits back to Communication menu.
Function selector	Exits back to main menu without changes.

Initialization procedure (Bluetooth dongle for the EurotestPV instrument):

- | |
|---|
| <ol style="list-style-type: none"> 1. Connect Bluetooth dongle A 1436 to the instrument's PS/2 port. 2. Switch on the instrument. 3. Press a RESET key on the Bluetooth dongle A 1436 for at least 10 seconds. 4. EurotestPV should be selected in INIT. BT DONGLES menu. Press the TEST key. 5. Wait for confirmation message and beep. Following message is displayed if dongle was initialized properly:
EXTERNAL BT DONGLE SEARCHING OK! |
|---|

Initialization procedure (Bluetooth dongle for the Metrel Powermeter):

- | |
|--|
| <ol style="list-style-type: none"> 1. Connect Bluetooth dongle A 1436 (intended to be used with the Metrel Powermeter) to the EurotestPV instrument's PS/2 port. 2. Switch on the EurotestPV instrument. 3. Press a RESET key on the Bluetooth dongle A 1436 for at least 10 seconds. 4. PowerQ series should be selected in INIT. BT DONGLES menu. Press the TEST key. |
|--|

5. Wait for confirmation message and beep. Following message is displayed if dongle was initialized properly:

EXTERNAL BT DONGLE SEARCHING OK!

6. The successfully initialized Bluetooth dongle A 1436 is now ready to be connected to a Metrel Powermeter.

Notes:

- The Bluetooth dongle A 1436 should always be initialized before first use with the EurotestPV instrument or Metrel Powermeter.
- If the dongle was initialized by another Metrel instrument it will probably not work properly when working with the previous instrument again. Bluetooth dongle initialization should be repeated in that case.
- For more information about communication via Bluetooth refer to chapter 8.6 Communication and A 1436 manual.

4.4.8 Initial settings

In this menu the instrument settings, measurement parameters and limits can be set to initial (factory) values.



Figure 4.167: Initial settings dialogue

Keys:

UP / DOWN	Selects option [YES, NO].
TEST	Restores default settings (if YES is selected).
ESC	Exits back to Settings menu.
Function selector	Exits back to main menu without changes.

Warning:

- ❑ Customized settings will be lost when this option is used!
- ❑ If the batteries are removed for more than 1 minute the custom made settings will be lost.

The default setup is listed below:

Instrument setting	Default value
Language	English
Contrast	As defined and stored by adjustment procedure
Isc factor	1.00
RCD standards	EN 61008 / EN 61009
Commander	Enabled
Communication	RS232
Clamp settings	
CLAMP 1	A1391, 40A
CLAMP 2	A1391, 40A
Solar settings	See chapter 4.4.10 Solar Settings

Test mode: Function Sub-function	Parameters / limit value
INSTALLATION:	
EARTH RE	No limit
R ISO	No limit U _{test} = 500 V
Low Ohm Resistance R LOWΩ CONTINUITY*	No limit No limit
Z - LINE VOLTAGE DROP	Fuse type: none selected ΔU: 4.0 % Z _{REF} : 0.00 Ω
Z - LOOP	Fuse type: none selected
Z _{S rcd}	Fuse type: none selected
RCD	RCD t Nominal differential current: I _{ΔN} =30 mA RCD type: AC <input type="checkbox"/> non-delayed Test current starting polarity:  (0°) Limit contact voltage: 50 V Current multiplier: ×1
POWER:	
CURRENT	C1
HARMONICS U I	U h:1
ENERGY	I: 40A, U: 260A
SOLAR:	

ISO PV	No limit U _{test} = 500 V
ENV.	Measured
I/V	Measured
INVERTER	AC/ DC

Note:

- Initial settings (reset of the instrument) can be recalled also if the TAB key is pressed while the instrument is switched on.

4.4.9 Clamp Settings

In Clamp settings menu the C1 and C2/P measuring inputs can be configured.

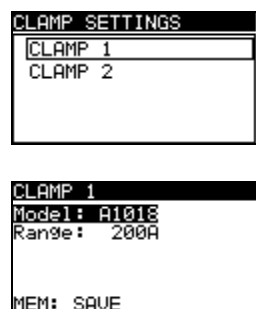

Figure 4.178: Configuration of current clamp measuring inputs

Parameters to be set:

Model	Model of current clamp [A1018, A1019, A1391].
Range	Measuring range of current clamp [20 A, 200 A], [40 A, 300 A].

Selection of measuring parameters

Keys

UP / DOWN	Selects appropriate option.
TEST	Enables changing data of selected parameter.
MEM	Saves settings.
ESC	Exits back to clamp settings menu.
Function selector	Exits back to main menu without changes.

Changing data of selected parameter

Keys

UP / DOWN	Sets parameter.
TEST	Confirms set data.
ESC	Disable changing data of selected parameter.
Function selector	Exits back to main menu without changes.

Note:

- Measuring range of the instrument must be considered. Measurement range of current clamp can be higher than of the instrument.

4.4.10 Synchronization (A 1378 - PV Remote unit)

The main purpose of the synchronization is to get correct values of temperature and irradiance for calculation of STC measurement results. During the PV tests the displayed STC results are calculated on base of set or measured environmental data in the instrument's **Environmental menu**. These values are not necessarily measured at the same time as other measurements.

Synchronization (of time stamps) enables to later update the PV measured results with environmental data that were measured simultaneously with the A 1378 PV Remote unit. Stored STC values are then corrected accordingly.

Selecting this option will allow synchronization of data between the instrument and PV Remote unit.

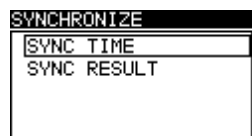

Figure 4.189: Synchronize menu

Data to be synchronized:

TIME	Instrument's time and date will be uploaded to the PV Remote unit.
RESULT	Values of measured environmental parameters will be downloaded to the instrument. Saved STC results will be corrected accordingly.

Keys:

UP / DOWN	Selects data to be synchronized.
TEST	Synchronizes data. Follow the information on the LCD. If the synchronization succeeded a confirmation beep will follow after short connecting... and synchronizing... messages.
ESC	Exits back to settings menu.
Function selector	Exits back to main menu.

Connection for synchronization

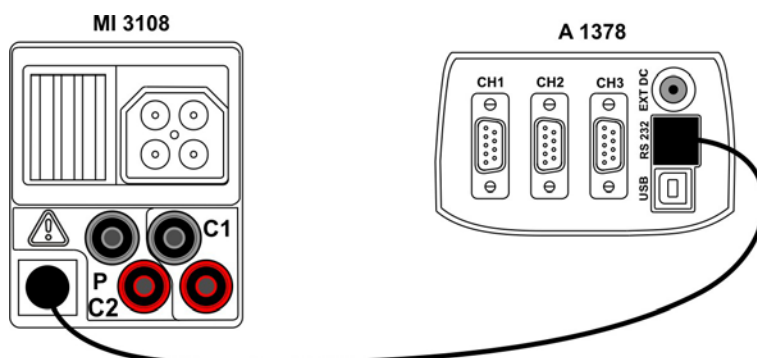

Figure 4.20: Connection of the instruments during synchronization

Note:

- Refer to A 1378 PV Remote unit user manual for more information.

4.4.11 Solar settings

In Solar settings parameters of PV modules and settings for PV measurements can be set.

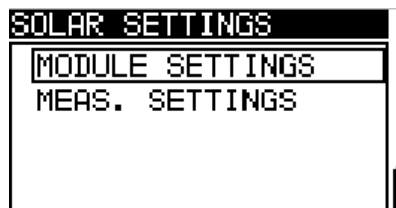

Figure 4.21: Solar settings

Keys:

UP / DOWN	Selects option.
TEST	Enters menu for changing parameters.
ESC	Exits back to settings menu.
Function selector	Exits back to main menu without changes.

PV module settings

Parameters of PV modules can be set in this menu. A database for up to 20 PV modules can be created / edited. Parameters are used for calculation of STC values.

Note:

- The database can be also created on the PC or mobile device and then sent to the instrument. PCSW EuroLinkPRO and some Android applications support this feature.

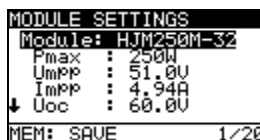

Figure 4.22: PV module settings menu

Parameters of PV module:

Module		PV module name
Pmax	1 W ..2000 W	Nominal power of PV module
Ump	1.0 V .. 999 V	Voltage on maximum power point
Imp	0.01 A .. 15.0 A	Current on maximum power point
Uoc	1.0 V .. 999 V	Open circuit voltage of module
Isc	0.01 A .. 15.0 A	Short circuit current of module
NOCT	1.0 °C .. 99.0 °C	Nominal working temperature of PV cell
alfa	-5.00 mA/°C .. 300 mA/°C	Temperature coefficient of Isc
beta	-5.00 V/°C .. -0.001 V/°C	Temperature coefficient of Uoc
gamma	-5.00 %/°C .. 0.999 %/°C	Temperature coefficient of Pmax
Rs	0.01 Ω .. 9.99 Ω	Serial resistance of PV module

Selection of PV module type and parameters

Keys:

UP / DOWN	Selects appropriate option.
TEST	Enters menu for changing type or parameters.

ESC, Function selector	Exits back.
MEM	Enters PV module type memory menu.

Changing a PV module type / parameter

Keys:

UP / DOWN	Sets value / data of parameter / PV module type.
TEST	Confirms set value / data.
ESC, Function selector	Exits back.

PV module type memory menu

ADD	Enters menu for adding a new PV module type.
OVERWRITE	Enters menu for storing changed data of selected PV module type.
DELETE	Deletes selected PV module type.
DELETE ALL	Deletes all PV module types.

Keys:

UP / DOWN	Selects option.
TEST	Enters selected menu.
Function selectors	Exits back to main function menu.

If **Add** or **Overwrite** is selected the menu for setting the PV module type name is displayed.



Figure 4.23: Setting name of PV module type

Keys:

▲ / ▼	Selects a character.
TEST	Selects the next character.
MEM	Confirms new name and stores it in the memory. Then returns to Module settings menu .
ESC	Deletes last letter. Returns to previous menu without changes.

If **Delete** or **Delete all** is selected a warning will be displayed.

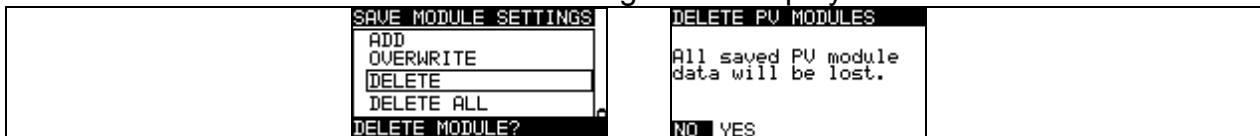

Figure 4.194: Delete options

Keys:

TEST	Confirms clearing. In Delete all option YES must be selected.
ESC / Function selector	Exits back to main function menu without changes.

PV measurements settings

Parameters for PV measurements can be set in this menu.

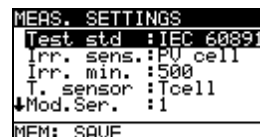

Figure 4.205: Selection of PV measurement settings

Parameters for PV measurements:

Test std	Testing standard [IEC 60891, CEI 82-25]
Irr. Sens.	Type of irradiance measuring sensor [PV cell, Pyran.]
Irr. min.	Minimal valid solar irradiance for calculation [500 – 1000 W/m ²]
T. sensor	Temperature for calculation [Tamb, Tcell]
Mod.Ser.	Number of modules in serial [1 – 30]
Mod.Par.	Number of modules in parallel [1 – 10]

Selection of PV test parameters

Keys:

UP / DOWN	Selects appropriate option.
TEST	Enables changing data of selected parameter.
MEM	Saves settings.
ESC / Function selector	Exits back.

Changing data of selected parameter

Keys:

UP / DOWN	Sets parameter.
TEST	Confirms set data.
ESC / Function selector	Exits back.

5 Measurements – a.c. LV installations

5.1 Voltage, frequency and phase sequence

Voltage and frequency measurement is always active in the terminal voltage monitor. In the special **VOLTAGE TRMS** menu the measured voltage, frequency and information about detected three-phase connection can be stored. Measurements are based on the EN 61557-7 standard.

See chapter 4.2 Function selection for instructions on key functionality.

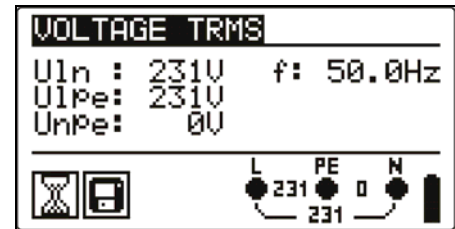

Figure 5.1: Voltage in single phase system

Test parameters for voltage measurement

There are no parameters to be set.

Connections for voltage measurement

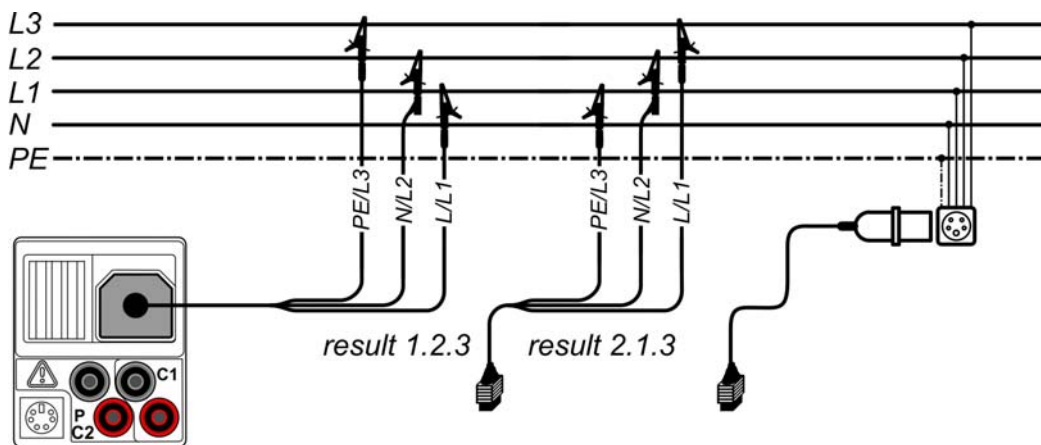

Figure 5.2: Connection of 3-wire test lead and optional adapter in three-phase system

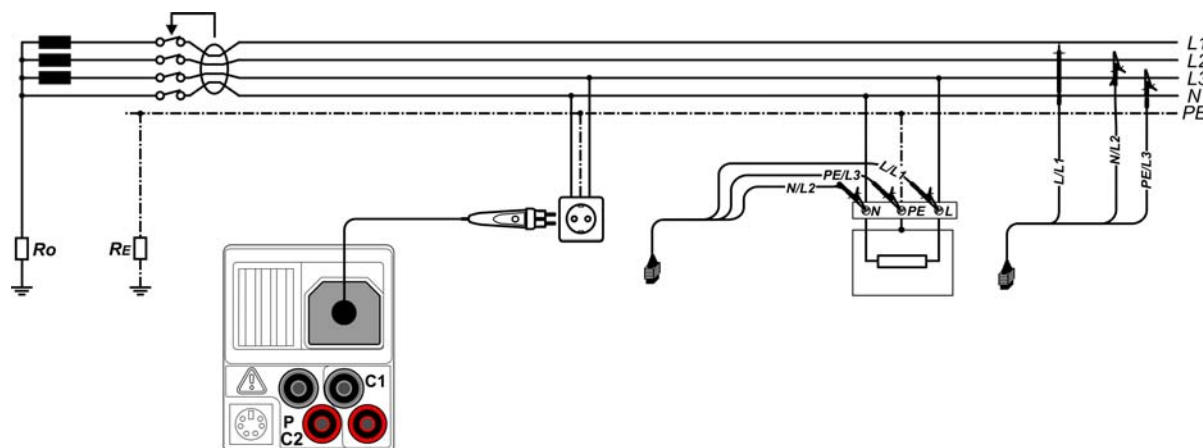

Figure 5.3: Connection of plug commander and 3-wire test lead in single-phase system

Voltage measurement procedure

- ❑ Select the **VOLTAGE TRMS** function using the function selector keys.
- ❑ **Connect** test cable to the instrument.
- ❑ **Connect** test leads to the item to be tested (see figures 5.2 and 5.3).
- ❑ **Store** voltage measurement result by pressing the MEM key (optional).

Measurement runs immediately after selection of **VOLTAGE TRMS** function.

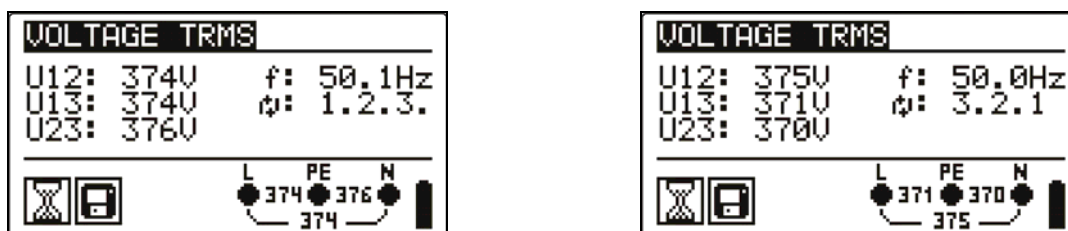

Figure 5.4: Examples of voltage measurement in three-phase system

Displayed results for single phase system:

U_{In}..... Voltage between phase and neutral conductors,

U_{Ipe}..... Voltage between phase and protective conductors,

U_{npe}..... Voltage between neutral and protective conductors,

f..... frequency.

Displayed results for three-phase system:

U₁₂..... Voltage between phases L1 and L2,

U₁₃..... Voltage between phases L1 and L3,

U₂₃..... Voltage between phases L2 and L3,

1.2.3 Correct connection – CW rotation sequence,

3.2.1 Invalid connection – CCW rotation sequence,

f..... frequency.

5.2 Insulation resistance

The Insulation resistance measurement is performed in order to ensure safety against electric shock through insulation. Typical applications are:

- ❑ Insulation resistance between conductors of installation,
- ❑ Insulation resistance of non-conductive rooms (walls and floors),
- ❑ Insulation resistance of ground cables,
- ❑ Resistance of semi-conductive (antistatic) floors.

See chapter 4.2 Function selection for instructions on key functionality.

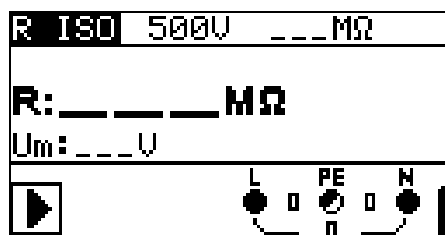

Figure 5.5: Insulation resistance

Test parameters for insulation resistance measurement

Uiso	Test voltage [50 V, 100 V, 250 V, 500 V, 1000 V]
Limit	Minimum insulation resistance [OFF, 0.01 MΩ ÷ 200 MΩ]

Test circuits for insulation resistance

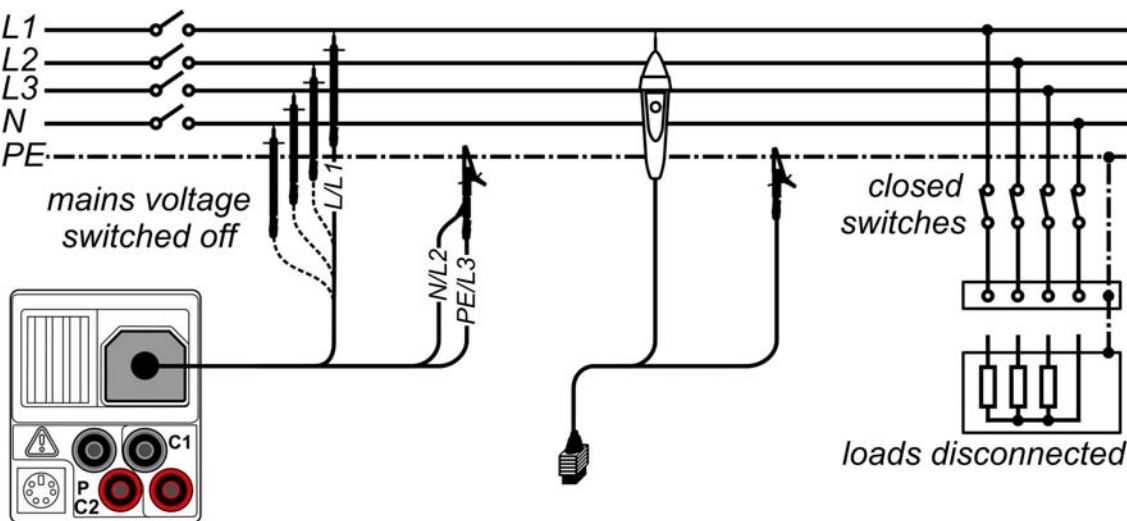

Figure 5.6: Connections for insulation measurement

Insulation resistance measuring procedure

- ❑ Select the **R ISO** function using the function selector keys.
- ❑ Set the required **test voltage**.
- ❑ Enable and set **limit** value (optional).
- ❑ **Disconnect** tested installation from mains supply (and discharge insulation as required).
- ❑ **Connect** test cable to the instrument and to the item to be tested (see figure 5.6).
- ❑ Press the **TEST** key to perform the measurement (double click for continuous measurement and later press to stop the measurement).
- ❑ After the measurement is finished wait until tested item is fully discharged.
- ❑ **Store** the result by pressing the MEM key (optional).

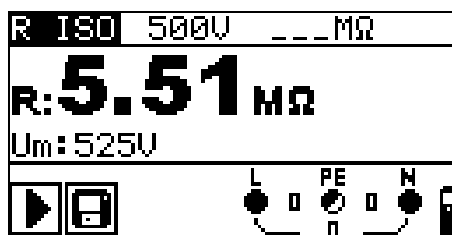

Figure 5.7: Example of insulation resistance measurement result

Displayed results:

R.....Insulation resistance
 Um.....Test voltage – actual value.

5.3 Resistance of earth connection and equipotential bonding

The resistance measurement is performed in order to ensure that the protective measures against electric shock through earth connections and bondings are effective. Two sub-functions are available:

- R LOWΩ - Earth bond measurement according to EN 61557-4 (200 mA),
- CONTINUITY - Continuous resistance measurement performed with 7 mA.

See chapter 4.2 Function selection for instructions on key functionality.

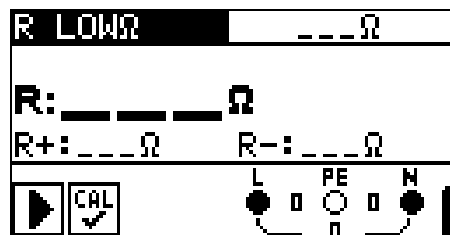

Figure 5.8: 200 mA RLOW Ω

Test parameters for resistance measurement

TEST	Resistance measurement sub-function [R LOWΩ, CONTINUITY]
Limit	Maximum resistance [OFF, 0.1 Ω ÷ 20.0 Ω]

Additional test parameter for In Continuity sub-function

	Buzzer On (sound if resistance is lower than the set limit value) or Off
--	--

5.3.1 R LOWΩ, 200 mA resistance measurement

The resistance measurement is performed with automatic polarity reversal of the test voltage.

Test circuit for R LOWΩ measurement

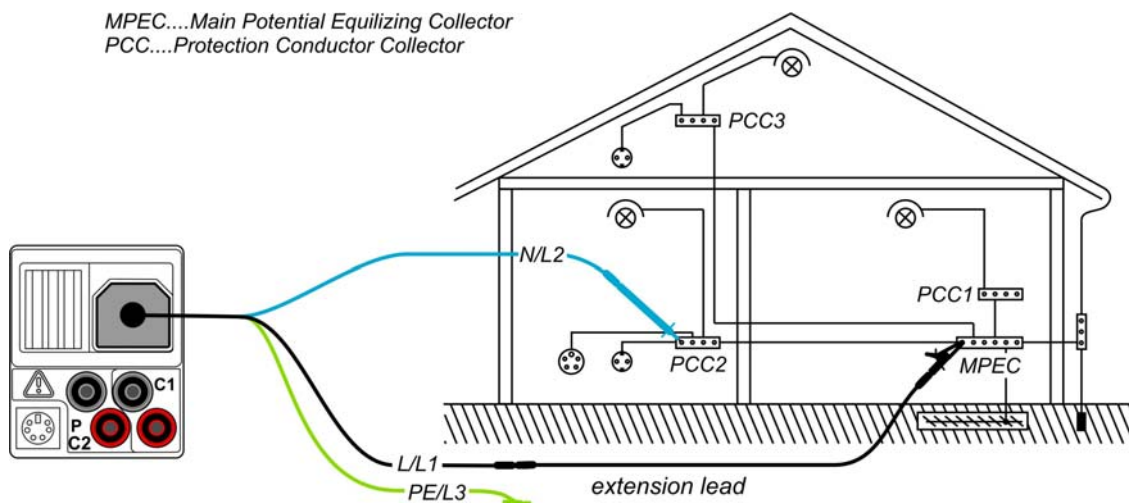

Figure 5.9: Connection of 3-wire test lead plus optional extension lead

R LOW Ω measurement procedure

- ❑ Select continuity function using the function selector keys.
- ❑ Set sub-function to **R LOW Ω** .
- ❑ Enable and set **limit** (optional).
- ❑ **Connect** test cable to the instrument.
- ❑ **Compensate** the test leads resistance (if necessary, see *section 5.3.3*).
- ❑ **Disconnect** from mains supply and discharge installation to be tested.
- ❑ **Connect** the test leads to the appropriate PE wiring (see *figure 5.9*).
- ❑ Press the **TEST** key to perform the measurement.
- ❑ After the measurement is finished **store** the result by pressing the MEM button (optional)*.

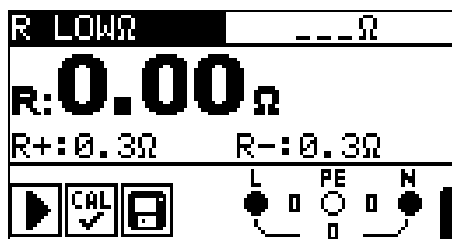

Figure 5.10: Example of RLOW result

Displayed result:

- R.....R LOW Ω resistance.
- R+.....Result at positive polarity
- R-.....Result at negative test polarity

5.3.2 Continuous resistance measurement with low current

In general, this function serves as standard Ω -meter with a low testing current. The measurement is performed continuously without polarity reversal. The function can also be applied for testing continuity of inductive components.

Test circuit for continuous resistance measurement

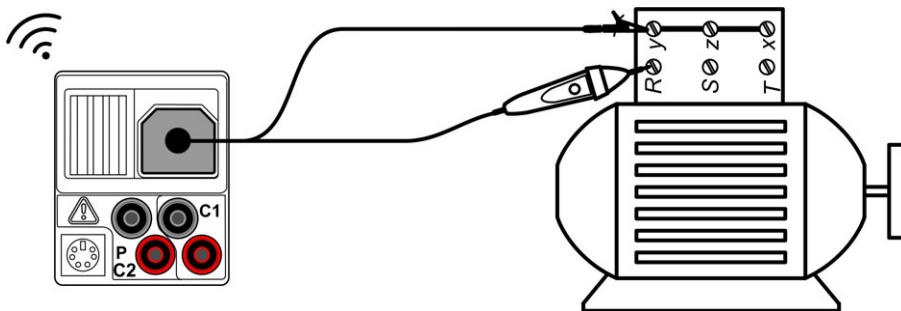

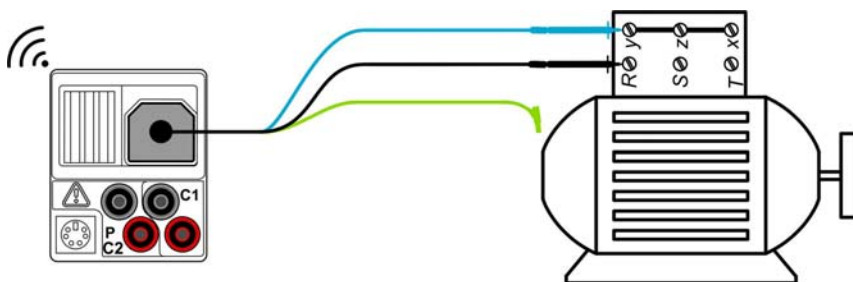

Figure 5.11: Tip commander and 3-wire test lead applications

Continuous resistance measurement procedure

- ❑ Select continuity function using the function selector keys.
- ❑ Set sub-function **CONTINUITY**.
- ❑ Enable and set the **limit** (optional).
- ❑ **Connect** test cable to the instrument.
- ❑ **Compensate** test leads resistance (if necessary, see *section 5.3.3*).
- ❑ **Disconnect** from mains supply and discharge the object to be tested.
- ❑ **Connect** test leads to the tested object (see *figure 5.11*).
- ❑ Press the **TEST** key to begin performing a continuous measurement.
- ❑ Press the **TEST** key to stop measurement.
- ❑ After the measurement is finished, **store** the result (optional).

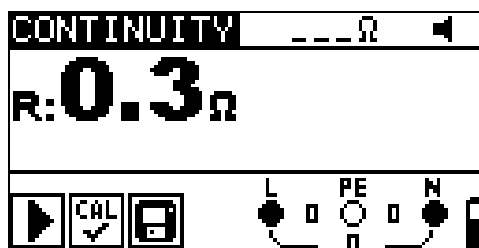

Figure 5.12: Example of continuous resistance measurement

Displayed result:

R.....Resistance

5.3.3 Compensation of test leads resistance

This chapter describes how to compensate the test leads resistance in both continuity functions, R LOW Ω and CONTINUITY. Compensation is required to eliminate the influence of test leads resistance and the internal resistances of the instrument on the measured resistance. The lead compensation is therefore a very important feature to obtain correct result.

 symbol is displayed if the compensation was carried out successfully.

Circuits for compensating the resistance of test leads

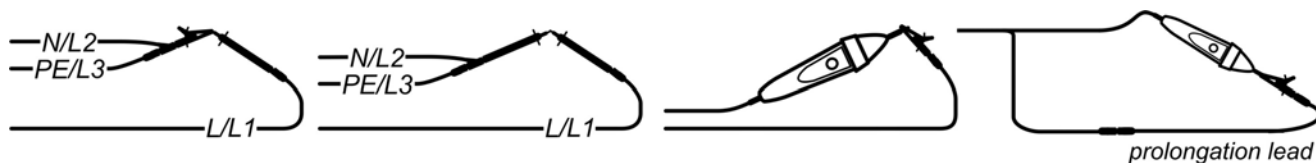

Figure 5.13: Shorted test leads

Compensation of test leads resistance procedure

- ❑ Select **R LOWΩ** or **CONTINUITY** function.
- ❑ **Connect** test cable to the instrument and short the test leads together (see figure 5.13).
- ❑ Press **TEST** to perform resistance measurement.
- ❑ Press the **CAL** key to compensate leads resistance.

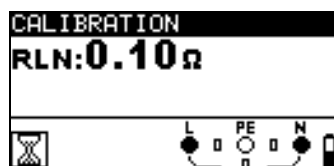

Figure 5.14: Results with old calibration values



Figure 5.15: Results with new calibration values

Note:

- ❑ The highest value for lead compensation is 5 Ω. If the resistance is higher the compensation value is set back to default value.

CAL
✕ is displayed if no calibration value is stored.

5.4 Testing RCDs

Various test and measurements are required for verification of RCD(s) in RCD protected installations. Measurements are based on the EN 61557-6 standard.

The following measurements and tests (sub-functions) can be performed:

- ❑ Contact voltage,
- ❑ Trip-out time,
- ❑ Trip-out current,
- ❑ RCD autotest.

See chapter 4.2 Function selection for instructions on key functionality.

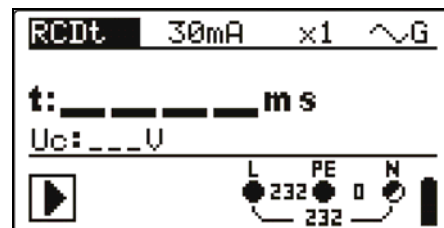

Figure 5.16: RCD test

Test parameters for RCD test and measurement

TEST	RCD sub-function test [RCDt, RCD I, AUTO, Uc].
$I_{\Delta N}$	Rated RCD residual current sensitivity $I_{\Delta N}$ [10 mA, 30 mA, 100 mA, 300 mA, 500 mA, 1000 mA].
type	RCD type AC, A, F, B, B+, starting polarity [~ , ~ , ~ , ~ , ~ , ~], selective <input checked="" type="checkbox"/> or general <input type="checkbox"/> characteristic.
MUL	Multiplication factor for test current [$\frac{1}{2}$, 1, 2, 5 $I_{\Delta N}$].
Ulim	Conventional touch voltage limit [25 V, 50 V].

Notes:

- ❑ Ulim can be selected in the Uc sub-function only.
- ❑ Selective (time delayed) RCDs have delayed response characteristics. As the contact voltage pre-test or other RCD tests influence the time delayed RCD it takes a certain period to recover into normal state. Therefore a time delay of 30 s is inserted before performing trip-out test by default.

Connections for testing RCD

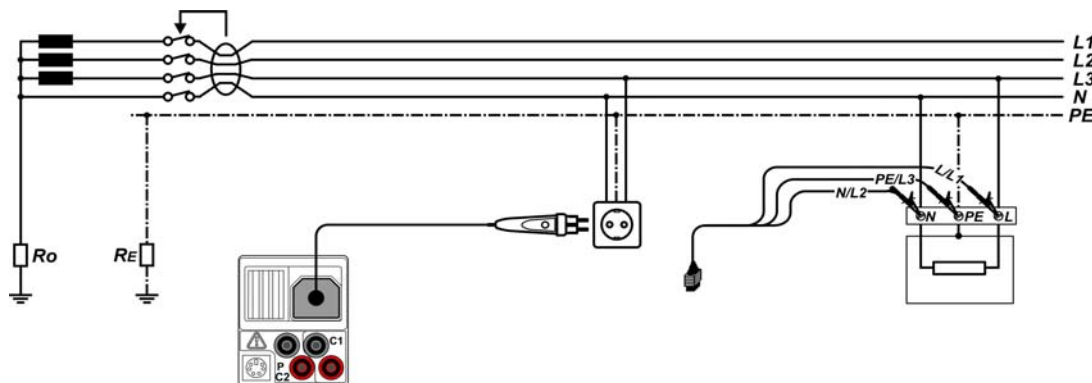

Figure 5.17: Connecting the plug commander and the 3-wire test lead

5.4.1 Contact voltage (RCD Uc)

A current flowing into the PE terminal causes a voltage drop on earth resistance, i.e. voltage difference between PE equipotential bonding circuit and earth. This voltage difference is called contact voltage and is present on all accessible conductive parts connected to the PE. It shall always be lower than the conventional safety limit voltage. The contact voltage is measured with a test current lower than $\frac{1}{2} I_{\Delta N}$ to avoid trip-out of the RCD and then normalized to the rated $I_{\Delta N}$.

Contact voltage measurement procedure

- ❑ Select the **RCD** function using the function selector keys.
- ❑ Set sub-function **Uc**.
- ❑ Set test **parameters** (if necessary).
- ❑ **Connect** test cable to the instrument.
- ❑ **Connect** test leads to the item to be tested (see *figure 5.17*).
- ❑ Press the **TEST** key to perform the measurement.
- ❑ **Store** the result by pressing the MEM key (optional).

The contact voltage result relates to the rated nominal residual current of the RCD and is multiplied by an appropriate factor (depending on RCD type and type of test current). The 1.05 factor is applied to avoid negative tolerance of result. See table 5.1 for detailed contact voltage calculation factors.

RCD type		Contact voltage Uc proportional to	Rated $I_{\Delta N}$
AC	<input type="checkbox"/>	$1.05 \times I_{\Delta N}$	any
AC	<input type="checkbox"/> S	$2 \times 1.05 \times I_{\Delta N}$	
A, F	<input type="checkbox"/>	$1.4 \times 1.05 \times I_{\Delta N}$	$\geq 30 \text{ mA}$
A, F	<input type="checkbox"/> S	$2 \times 1.4 \times 1.05 \times I_{\Delta N}$	
A, F	<input type="checkbox"/>	$2 \times 1.05 \times I_{\Delta N}$	$< 30 \text{ mA}$
A, F	<input type="checkbox"/> S	$2 \times 2 \times 1.05 \times I_{\Delta N}$	
B, B+	<input type="checkbox"/>	$2 \times 1.05 \times I_{\Delta N}$	any
B, B+	<input type="checkbox"/> S	$2 \times 2 \times 1.05 \times I_{\Delta N}$	

Table 5.1: Relationship between U_c and $I_{\Delta N}$

Loop resistance is indicative and calculated from U_c result (without additional proportional factors) according to: $R_L = \frac{U_c}{I_{\Delta N}}$.

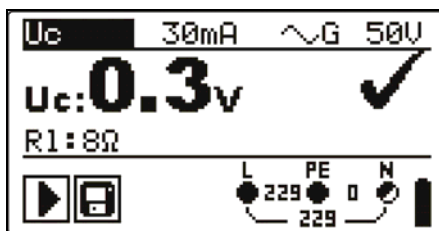

Figure 5.18: Example of contact voltage measurement results

Displayed results:

Uc.....Contact voltage.

RI.....Fault loop resistance.

5.4.2 Trip-out time (RCDt)

Trip-out time measurement verifies the sensitivity of the RCD at different residual currents.

Trip-out time measurement procedure

- ❑ Select the **RCDt** function using the function selector keys.
- ❑ Set sub-function **RCDt**.
- ❑ Set test **parameters** (if necessary).
- ❑ **Connect** test cable to the instrument.
- ❑ **Connect** test leads to the item to be tested (see figure 5.17).
- ❑ Press the **TEST** key to perform the measurement.
- ❑ **Store** the result by pressing the MEM key (optional).

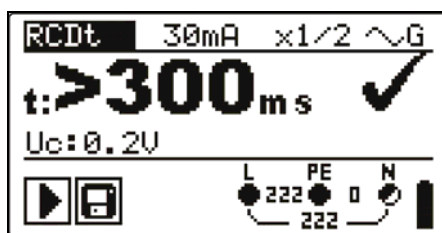

Figure 5.19: Example of trip-out time measurement results

Displayed results:

t.....Trip-out time,

Uc.....Contact voltage for rated $I_{\Delta N}$.

5.4.3 Trip-out current (RCD I)

A continuously rising residual current is intended for testing the threshold sensitivity for RCD trip-out. The instrument increases the test current in small steps through appropriate range as follows:

RCD type	Slope range		Waveform
	Start value	End value	
AC	$0.2 \times I_{\Delta N}$	$1.1 \times I_{\Delta N}$	Sine
A, F ($I_{\Delta N} \geq 30 \text{ mA}$)	$0.2 \times I_{\Delta N}$	$1.5 \times I_{\Delta N}$	Pulsed
A, F ($I_{\Delta N} = 10 \text{ mA}$)	$0.2 \times I_{\Delta N}$	$2.2 \times I_{\Delta N}$	
B, B+	$0.2 \times I_{\Delta N}$	$2.2 \times I_{\Delta N}$	DC

Maximum test current is I_{Δ} (trip-out current) or end value in case the RCD didn't trip-out.

Trip-out current measurement procedure

- ❑ Select the **RCD** function using the function selector keys.
- ❑ Set sub-function **RCD I**.
- ❑ Set test **parameters** (if necessary).
- ❑ **Connect** test cable to the instrument.
- ❑ **Connect** test leads to the item to be tested (see *figure 5.17*).
- ❑ Press the **TEST** key to perform the measurement.
- ❑ **Store** the result by pressing the MEM key (optional).

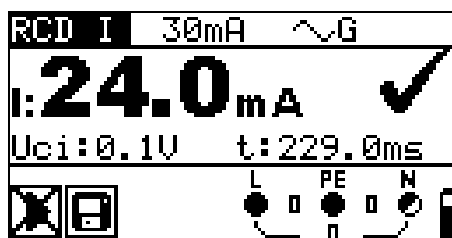

Figure 5.20: Trip-out current measurement result example

Displayed results:

I.....Trip-out current,

Uci...Contact voltage at trip-out current I or end value in case the RCD didn't trip,

t.....Trip-out time.

5.4.4 RCD Autotest

RCD autotest function is intended to perform a complete RCD test (trip-out time at different residual currents, trip-out current and contact voltage) in one set of automatic tests, guided by the instrument.

Additional key:

HELP / DISPLAY	Toggles between top and bottom part of results field.
-----------------------	---

RCD autotest procedure

RCD Autotest steps	Notes
<ul style="list-style-type: none"> <input type="checkbox"/> Select the RCD function using the function selector keys. <input type="checkbox"/> Set sub-function AUTO. <input type="checkbox"/> Set test parameters (if necessary). <input type="checkbox"/> Connect test cable to the instrument. <input type="checkbox"/> Connect test leads to the item to be tested (see <i>figure 5.17</i>). <input type="checkbox"/> Press the TEST key to perform the test. 	Start of test
<ul style="list-style-type: none"> <input type="checkbox"/> Test with $I_{\Delta N}$, 0° (step 1). 	RCD should trip-out
<ul style="list-style-type: none"> <input type="checkbox"/> Re-activate RCD. <input type="checkbox"/> Test with $I_{\Delta N}$, 180° (step 2). 	RCD should trip-out
<ul style="list-style-type: none"> <input type="checkbox"/> Re-activate RCD. <input type="checkbox"/> Test with $5 \times I_{\Delta N}$, 0° (step 3). 	RCD should trip-out
<ul style="list-style-type: none"> <input type="checkbox"/> Re-activate RCD. <input type="checkbox"/> Test with $5 \times I_{\Delta N}$, 180° (step 4). 	RCD should trip-out
<ul style="list-style-type: none"> <input type="checkbox"/> Re-activate RCD. <input type="checkbox"/> Test with $\frac{1}{2} \times I_{\Delta N}$, 0° (step 5). <input type="checkbox"/> Test with $\frac{1}{2} \times I_{\Delta N}$, 180° (step 6). 	RCD should not trip-out RCD should not trip-out
<ul style="list-style-type: none"> <input type="checkbox"/> Trip-out current test, 0° (step 7). 	RCD should trip-out
<ul style="list-style-type: none"> <input type="checkbox"/> Re-activate RCD. <input type="checkbox"/> Trip-out current test, 180° (step 8). 	RCD should trip-out
<ul style="list-style-type: none"> <input type="checkbox"/> Re-activate RCD. <input type="checkbox"/> Store the result by pressing the MEM key (optional). 	End of test

Result examples:

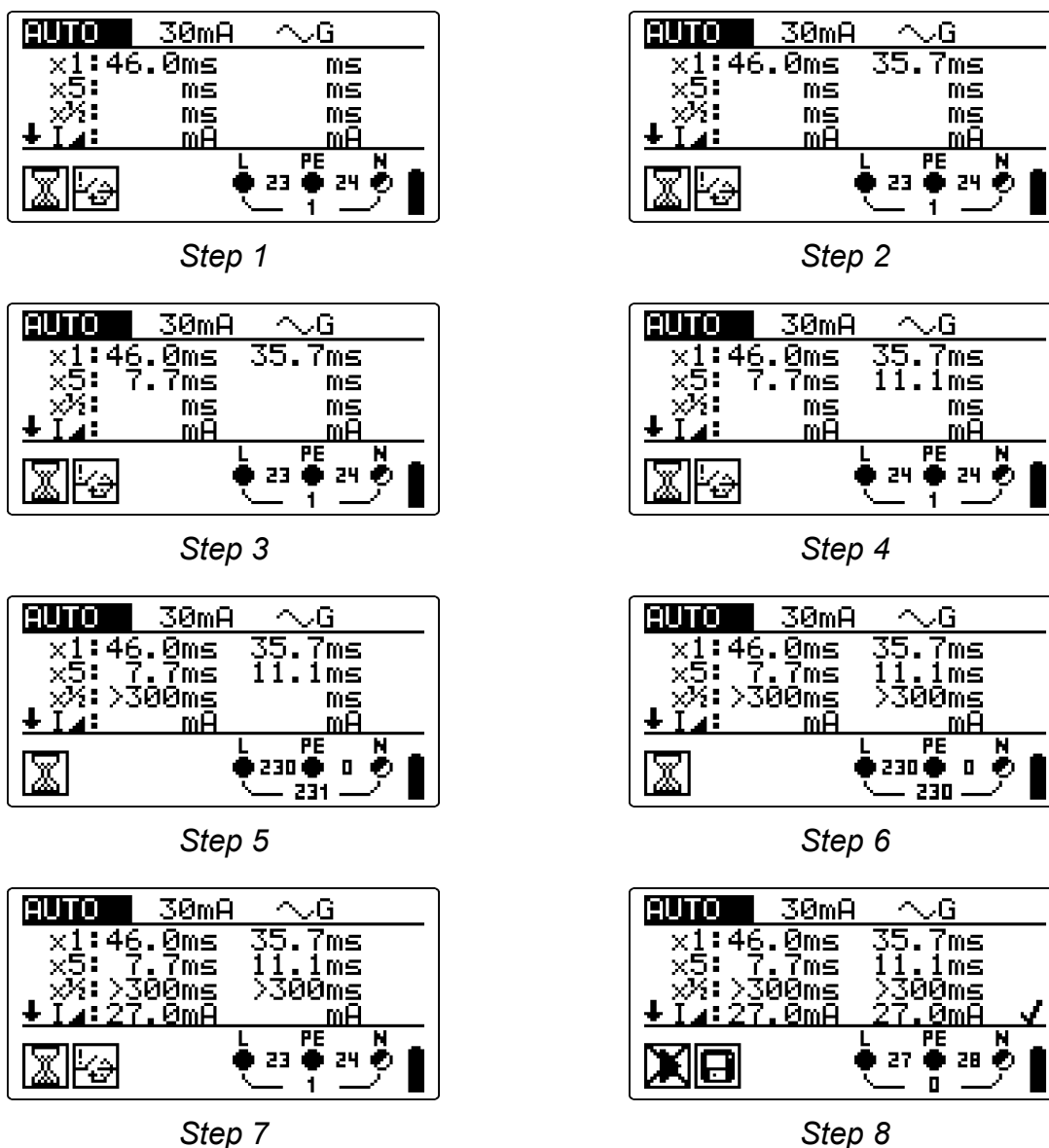

Figure 5.21: Individual steps in RCD autotest

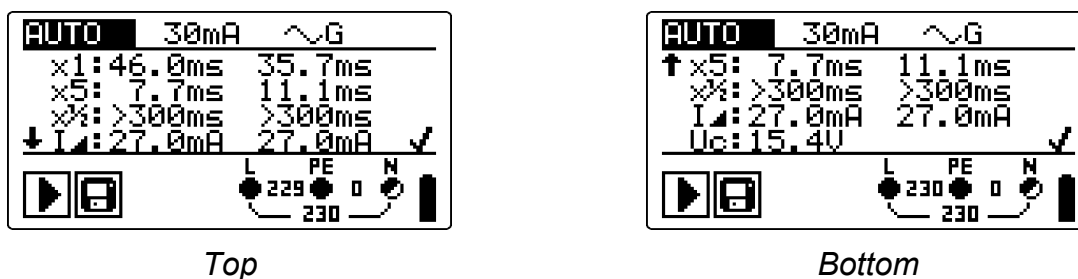

Figure 5.22: Two parts of result field in RCD autotest

Displayed results:

x1 Step 1 trip-out time (t_{x1} , $I\Delta N$, 0°),
 x1 Step 2 trip-out time (t_{x1} , $I\Delta N$, 180°),
 x5 Step 3 trip-out time (t_{x5} , $5 \times I\Delta N$, 0°),
 x5 Step 4 trip-out time (t_{x5} , $5 \times I\Delta N$, 180°),
 x $\frac{1}{2}$ Step 5 trip-out time ($t_{x\frac{1}{2}}$, $\frac{1}{2} \times I\Delta N$, 0°),
 x $\frac{1}{2}$ Step 6 trip-out time ($t_{x\frac{1}{2}}$, $\frac{1}{2} \times I\Delta N$, 180°),
 I \blacktriangleleft Step 7 trip-out current (0°),
 I \blacktriangleleft Step 8 trip-out current (180°),
 Uc Contact voltage for rated $I\Delta N$.

Notes:

- The autotest sequence is immediately stopped if any incorrect condition is detected, e.g. excessive Uc or trip-out time out of bounds.
- Auto test is finished without x5 tests in case of testing the RCD types A, F with rated residual currents of $I\Delta n = 300$ mA, 500 mA, and 1000 mA. In this case auto test result passes if all other results pass, and indications for x5 are omitted.
- Tests for sensitivity (I \blacktriangleleft ., steps 7 and 8) are omitted for selective type RCD.

5.5 Fault loop impedance and prospective fault current

Fault loop is a loop comprised by mains source, line wiring and PE return path to the mains source. The instrument measures the impedance of the loop and calculates the short circuit current. The measurement is covered by requirements of the EN 61557-3 standard.

See chapter 4.2 Function selection for instructions on key functionality.

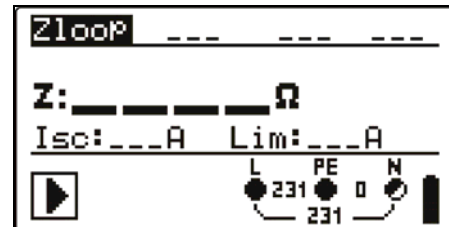

Figure 5.23: Fault loop impedance

Test parameters for fault loop impedance measurement

Test	Selection of fault loop impedance sub-function [Zloop, Zs rcd]
Fuse type	Selection of fuse type [---, NV, gG, B, C, K, D]
Fuse I	Rated current of selected fuse
Fuse T	Maximum breaking time of selected fuse
Lim	Minimum short circuit current for selected fuse.

See Appendix A for reference fuse data.

Circuits for measurement of fault loop impedance

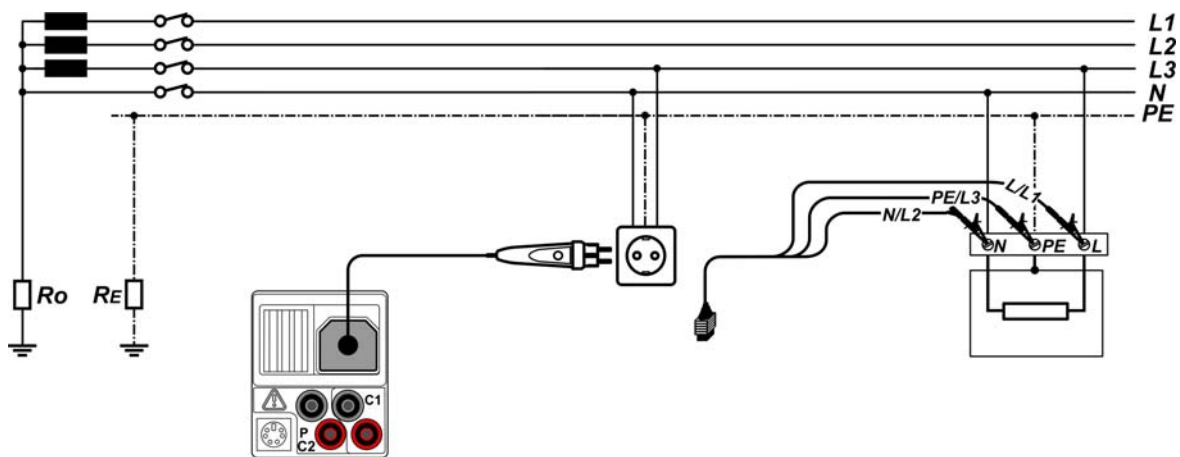

Figure 5.24: Connection of plug commander and 3-wire test lead

Fault loop impedance measurement procedure

- ❑ Select the **Zloop** or **Zs rcd** sub-function using the function selector keys and Δ/∇ keys.
- ❑ Select test **parameters** (optional).
- ❑ **Connect** test cable to the instrument.
- ❑ **Connect** test leads to the item to be tested (see figures 5.17 and 5.24).
- ❑ Press the **TEST** key to perform the measurement.
- ❑ **Store** the result by pressing the MEM key (optional).

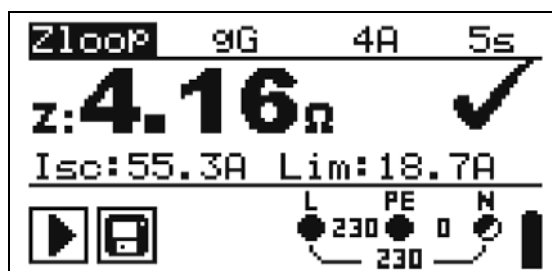

Figure 5.25: Example of loop impedance measurement result

Displayed results:

Z..... Fault loop impedance,

Isc..... Prospective fault current,

Lim Low limit prospective short-circuit current value.

Prospective fault current I_{SC} is calculated from measured impedance as follows:

$$I_{SC} = \frac{U_n \times k_{SC}}{Z}$$

where:

U_n Nominal U_{L-PE} voltage (see table below),

k_{SC} Correction factor for I_{SC} (see chapter 4.4.5).

U_n	Input voltage range (L-PE)
110 V	$(93 \text{ V} \leq U_{L-PE} \leq 134 \text{ V})$
230 V	$(185 \text{ V} \leq U_{L-PE} \leq 266 \text{ V})$

Notes:

- ❑ High fluctuations of mains voltage can influence the measurement results (the noise sign  is displayed in the message field). In this case it is recommended to repeat few measurements to check if the readings are stable.
- ❑ This measurement will trip-out the RCD in RCD-protected electrical installation if test Zloop is selected.
- ❑ Select Zs rcd measurement to prevent trip-out of RCD in RCD protected installation.

5.6 Line impedance and prospective short-circuit current / Voltage drop

Line impedance is measured in loop comprising of mains voltage source and line wiring. Line impedance is covered by the requirements of the EN 61557-3 standard.

The Voltage drop sub-function is intended to check that a voltage in the installation stays above acceptable levels if the highest current is flowing in the circuit. The highest current is defined as the nominal current of the circuit's fuse. The limit values are described in the standard EN 60364-5-52.

Sub-functions:

- Z LINE - Line impedance measurement according to EN 61557-3,
- ΔU – Voltage drop measurement.

See chapter 4.2 Function selection for instructions on key functionality.



Figure 5.26: Line impedance

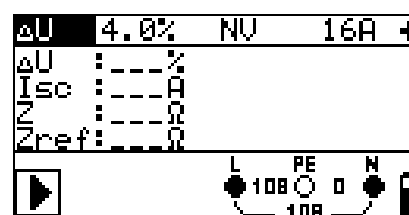

Figure 5.27: Voltage drop

Test parameters for line impedance measurement

Test	Selection of line impedance [Zline] or voltage drop [ΔU] sub-function
FUSE type	Selection of fuse type [---, NV, gG, B, C, K, D]
FUSE I	Rated current of selected fuse
FUSE T	Maximum breaking time of selected fuse
Lim	Minimum short circuit current for selected fuse.

See Appendix A for reference fuse data.

Additional test parameters for voltage drop measurement

ΔU_{MAX}	Maximum voltage drop [3.0 % ÷ 9.0 %].
------------------	--

5.6.1 Line impedance and prospective short circuit current

Circuits for measurement of line impedance

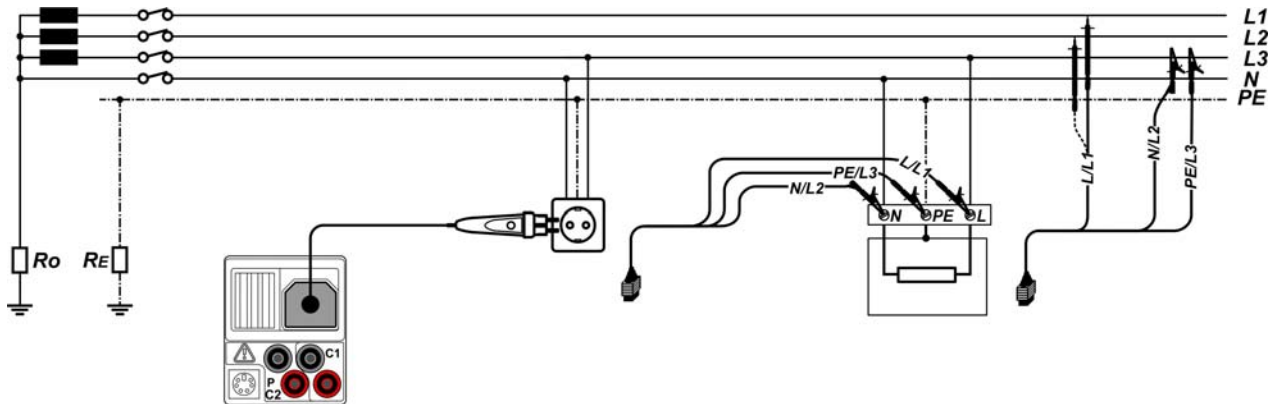

Figure 5.28: Phase-neutral or phase-phase line impedance measurement – connection of plug commander and 3-wire test lead

Line impedance measurement procedure

- ❑ Select the **zline** sub-function.
- ❑ Select test **parameters** (optional).
- ❑ **Connect** test cable to the instrument.
- ❑ **Connect** test leads to the item to be tested (see figure 5.28).
- ❑ Press the **TEST** key to perform the measurement.
- ❑ **Store** the result by pressing the MEM key (optional).

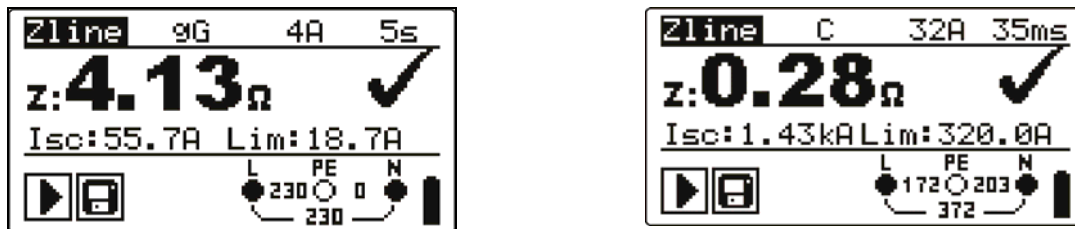

Figure 5.29: Examples of line impedance measurement result

Displayed results:

Z Line impedance,

Isc Prospective short-circuit current,

Lim Low limit prospective short-circuit current value.

Prospective short circuit current is calculated as follows:

$$I_{sc} = \frac{U_n \times k_{sc}}{Z}$$

where:

U_n Nominal L-N or L1-L2 voltage (see table below),

k_{sc} Correction factor for Isc (see chapter 4.5.5).

U_n	Input voltage range (L-N or L1-L2)
110 V	$(93 \text{ V} \leq U_{L-N} < 134 \text{ V})$
230 V	$(185 \text{ V} \leq U_{L-N} \leq 266 \text{ V})$
400 V	$(321 \text{ V} < U_{L-L} \leq 485 \text{ V})$

Note:

- High fluctuations of mains voltage can influence the measurement results (the noise sign  is displayed in the message field). In this case it is recommended to repeat few measurements to check if the readings are stable.

5.6.2 Voltage drop

The voltage drop is calculated based on the difference of line impedance at connection points (sockets) and the line impedance at the reference point (usually the impedance at the switchboard).

Circuits for measurement of voltage drop

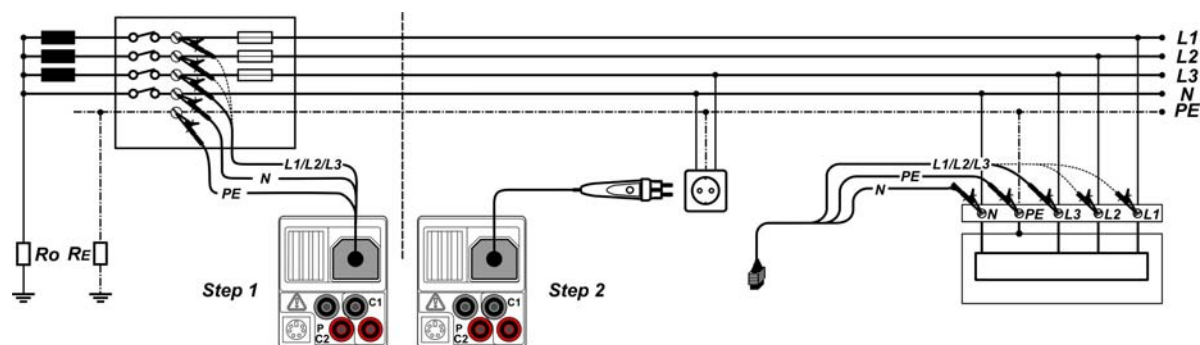

Figure 5.30: Phase-neutral or phase-phase voltage drop measurement – connection of plug commander and 3-wire test lead

Voltage drop measurement procedure

Step 1: Measuring the impedance Z_{ref} at origin

- Select the **ΔU** sub-function using the function selector keys and \uparrow/\downarrow keys.
- Select test **parameters** (optional).
- **Connect** test cable to the instrument.
- **Connect** the test leads to the origin of electrical installation (see figure 5.30).
- Press the **CAL** key to perform the measurement.

Step 2: Measuring the voltage drop

- Select the **ΔU** sub-function using the function selector keys and \uparrow/\downarrow keys.
- Select test **parameters** (Fuse type must be selected).
- **Connect** test cable or plug commander to the instrument.
- **Connect** the test leads to the tested points (see figure 5.30).
- Press the **TEST** key to perform the measurement.
- **Store** the result by pressing the MEM key (optional).

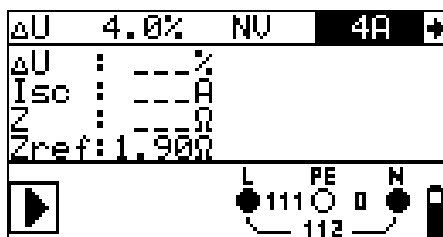

Step 1 - Zref

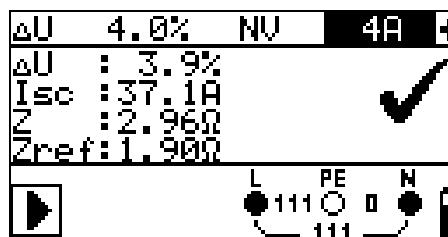

Step 2 - Voltage drop

Figure 5.31: Examples of voltage drop measurement result

Displayed results:

ΔU Voltage drop,

I_{sc} Prospective short-circuit current,

Z Line impedance at measured point,

Z_{ref} Reference impedance

Voltage drop is calculated as follows:

$$\Delta U[\%] = \frac{(Z - Z_{REF}) \cdot I_N}{U_N} \cdot 100$$

where:

ΔU calculated voltage drop

Z impedance at test point

Z_{REF} impedance at reference point

I_N rated current of selected fuse

U_N nominal voltage (see table below)

U_n	Input voltage range (L-N or L1-L2)
110 V	$(93 \text{ V} \leq U_{L-PE} < 134 \text{ V})$
230 V	$(185 \text{ V} \leq U_{L-PE} \leq 266 \text{ V})$
400 V	$(321 \text{ V} < U_{L-N} \leq 485 \text{ V})$

Notes:

- If the reference impedance is not set the value of Z_{REF} is considered as 0.00 Ω .
- The Z_{REF} is cleared (set to 0.00 Ω) if pressing CAL key while instrument is not connected to a voltage source.
- I_{SC} is calculated as described in chapter 5.6.1 Line impedance and prospective short circuit current.
- If the measured voltage is outside the ranges described in the table above the ΔU result will not be calculated.
- High fluctuations of mains voltage can influence the measurement results (the noise sign  is displayed in the message field). In this case it is recommended to repeat few measurements to check if the readings are stable.

5.7 Earth resistance

Earth resistance is one of the most important parameters for protection against electric shock. Main earthing arrangements, lightning systems, local earthings, etc can be verified with the earthing resistance test. The measurement conforms to the EN 61557-5 standard.

See chapter 4.2 Function selection for instructions on key functionality.



Figure 5.32: Earth resistance

Test parameters for earth resistance measurement

Limit	Maximum resistance OFF, 1 Ω ÷ 5 kΩ
-------	------------------------------------

Connections for earth resistance measurement

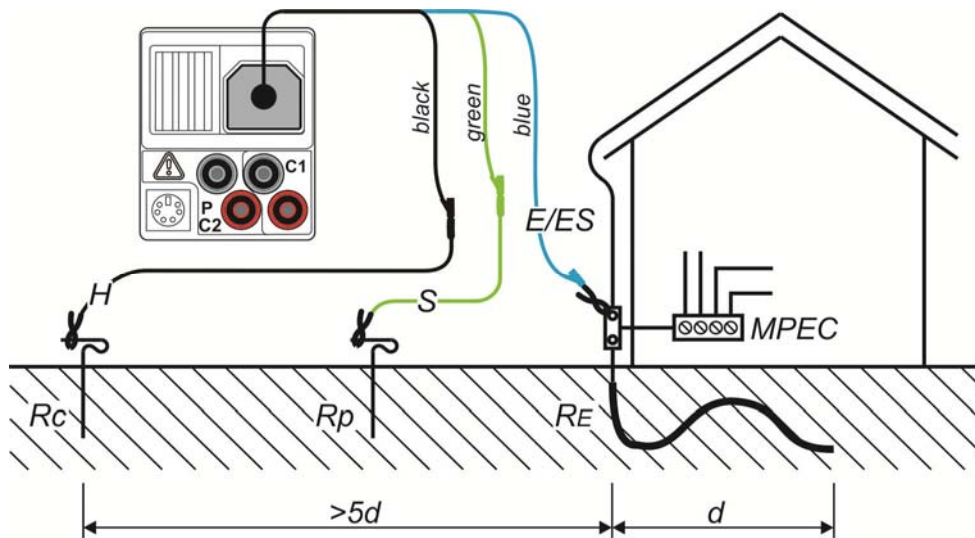

Figure 5.33: Resistance to earth, measurement of main installation earthing

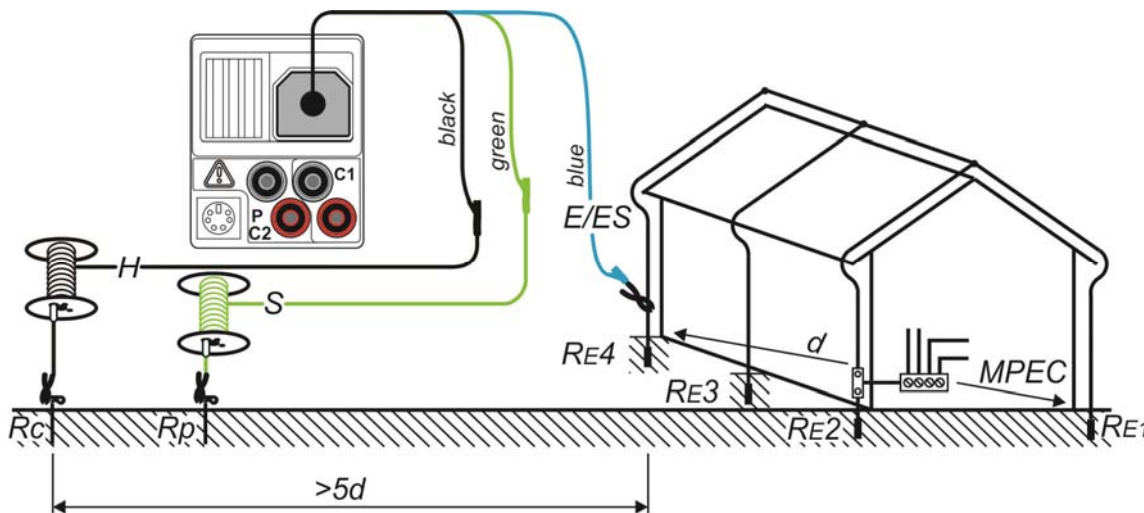

Figure 5.34: Resistance to earth, measurement of a lightning protection system

Earth resistance measurements, common measurement procedure

- ❑ Select **EARTH** function using the function selector keys.
- ❑ Enable and set **limit** value (optional).
- ❑ **Connect** test leads to the instrument.
- ❑ **Connect** the item to be tested (see figures 5.33, 5.34).
- ❑ Press the **TEST** key to perform the measurement.
- ❑ **Store** the result by pressing the MEM key (optional).



Figure 5.35: Example of earth resistance measurement result

Displayed results for earth resistance measurement:

- R.....Earth resistance,
- Rp.....Resistance of S (potential) probe,
- Rc.....Resistance of H (current) probe.

Notes:

- ❑ High resistance of S and H probes could influence the measurement results. In this case, “Rp” and “Rc” warnings are displayed. There is no pass / fail indication in this case.
- ❑ High noise currents and voltages in earth could influence the measurement results. The tester displays the  warning in this case.
- ❑ Probes must be placed at sufficient distance from the measured object.

5.8 PE test terminal

It can happen that a dangerous voltage is applied to the PE wire or other accessible metal parts. This is a very dangerous situation since the PE wire and MPEs are considered to be earthed. An often reason for this fault is incorrect wiring (see examples below).

When touching the **TEST** key in all functions that requires mains supply the user automatically performs this test.

Examples for application of PE test terminal

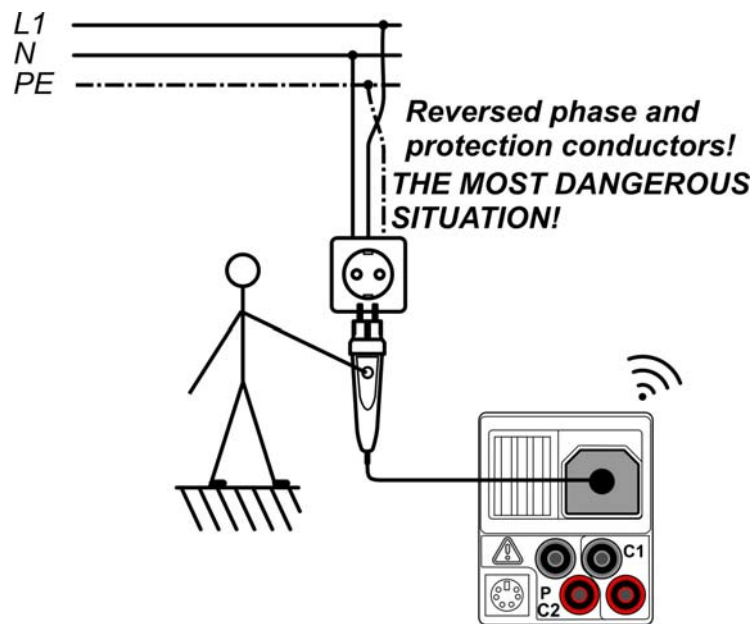

Figure 5.36: Reversed L and PE conductors (plug commander)

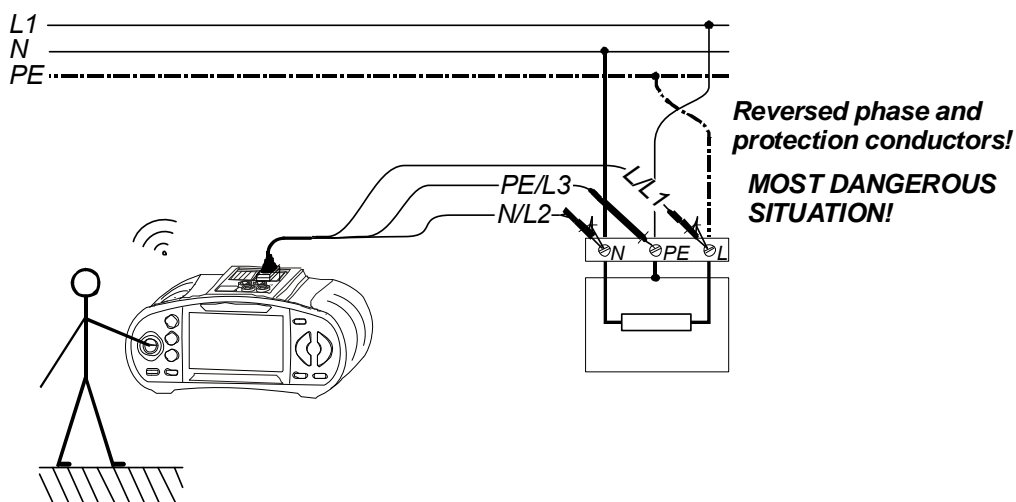

Figure 5.37: Reversed L and PE conductors (application of 3-wire test lead)

PE terminal test procedure

- ❑ **Connect** test cable to the instrument.
- ❑ **Connect** test leads to the item to be tested (see *figures 5.36 and 5.37*).
- ❑ Touch PE test probe (the **TEST** key) for at least one second.
- ❑ If PE terminal is connected to phase voltage the warning message is displayed, instrument buzzer is activated, and further measurements are disabled in Zloop and RCD functions.

Warning:

- ❑ If dangerous voltage is detected on the tested PE terminal, immediately stop all measurements, find and remove the fault!

Notes:

- ❑ PE test terminal is active in the INSTALLATION operating mode (except in the VOLTAGE, Low ohm, Earth and Insulation functions).
- ❑ PE test terminal does not operate in case the operator's body is completely insulated from floor or walls!
- ❑ For operation of PE test terminal on commanders refer to *Appendix D Commanders*.

6 Solar measurements - PV systems

The following measurements for verification and troubleshooting of PV installations can be performed with the instrument:

- Insulation resistance on PV systems
- PV inverter test
- PV panel test
- Environmental parameters
- Open voltage and short circuit test
- I-V curve test

6.1 Insulation resistance on PV systems

The Insulation resistance measurement is performed in order to ensure safety against electric shock through insulation between live parts on PV installations and earth.

The measurement is carried out according to test method 1 in IEC / EN 62446 (test between panel / string / array negative and earth followed by a test between panel / string / array positive and earth).

See chapter 4.2 Function selection for instructions on key functionality. The input voltage is displayed in order to check proper connection before carrying out the test.

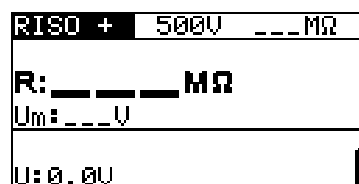

Figure 6.1: Insulation resistance

Test parameters for insulation resistance measurement on PV systems

TEST	RISO - RISO +
Uiso	Test voltage [50 V, 100 V, 250 V, 500 V, 1000 V]
Limit	Minimum insulation resistance [OFF, 0.01 MΩ ÷ 200 MΩ]

Test circuits for insulation resistance on PV systems

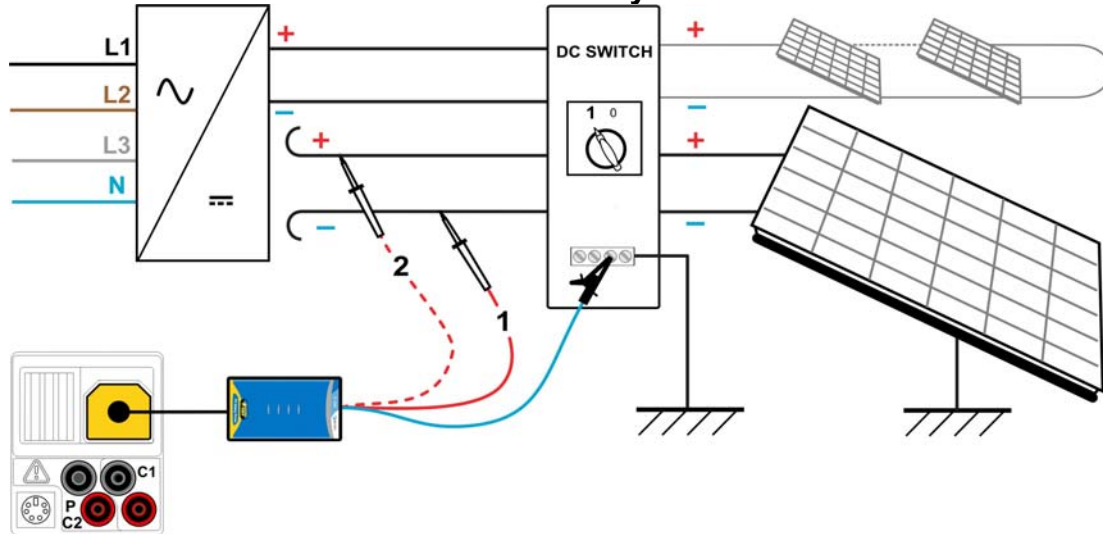

Figure 6.2: Connections for insulation resistance measurement on PV systems

Insulation resistance measuring procedure

- ❑ Select the **RISO -** sub-function using the function selector keys and $\blacktriangle/\blacktriangledown$ keys.
- ❑ Set the required **test voltage**.
- ❑ Enable and set **limit** value (optional).
- ❑ **Connect** PV safety probe to the instrument (see figure 6.2)
- ❑ **Connect** accessories to the PV system (see figure 6.2).
- ❑ Press the **TEST** key to perform the measurement (double click for continuous measurement and later press to stop the measurement).
- ❑ After the measurement is finished wait until tested item is fully discharged.
- ❑ **Store** the result by pressing the MEM key (optional).

- ❑ Select the **RISO +** sub-function using the $\blacktriangle / \blacktriangledown$ keys.
- ❑ **Reconnect** DC+ lead (see figure 6.2).
- ❑ Press the **TEST** key to perform the measurement (double click for continuous measurement and later press to stop the measurement).
- ❑ After the measurement is finished wait until tested item is fully discharged.
- ❑ **Store** the result by pressing the MEM key (optional).



Figure 6.3: Examples of insulation resistance measurement result

Displayed results:

R.....Insulation resistance
Um.....Test voltage – actual value.

6.2 PV inverter test

The test is intended to check proper operation of the PV inverter. Following functions are supported:

- Measuring of DC values at inverter’s input and AC values at inverter’s output.
- Calculation of the efficiency of the inverter.

With the EurotestPV instrument one DC and one AC signal can be measured at the same time.

For 3-phase inverters one DC and three AC signals can be measured at the same time with a combination of a Metrel Powermeter and the EurotestPV instrument. During the measurement the Power meter and EurotestPV instrument must be connected via serial cable or Bluetooth link. At the end of the measurement the results from Powermeter are sent to and displayed on the EurotestPV instrument.

See chapter 4.2 Function selection for instructions on key functionality. The input voltages are displayed in order to check proper connection before carrying out the test.

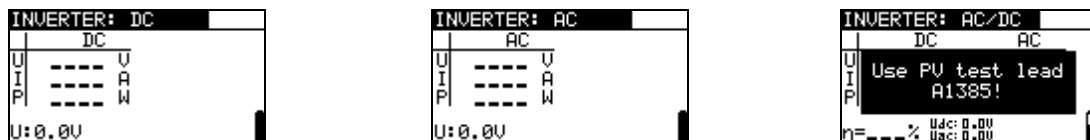

Figure 6.4: Examples of PV inverter test starting screens – one phase a.c output



Figure 6.5: Examples of PV inverter test starting screens – three phase a.c.output

Settings and parameters for PV inverter test

Input	Inputs/ Outputs being measured [AC, DC, AC/DC, AC3, AC3/DC]
-------	--

Connections for PV inverter test

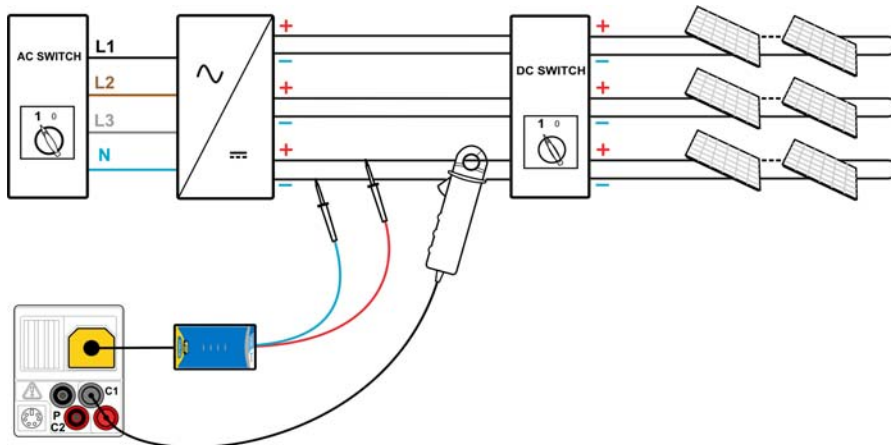

Figure 6.6: PV inverter test - DC side

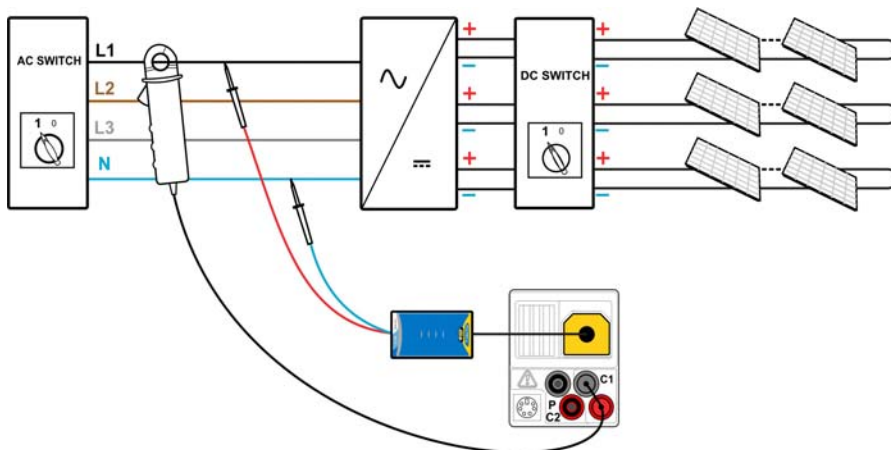

Figure 6.7: PV inverter test - AC side

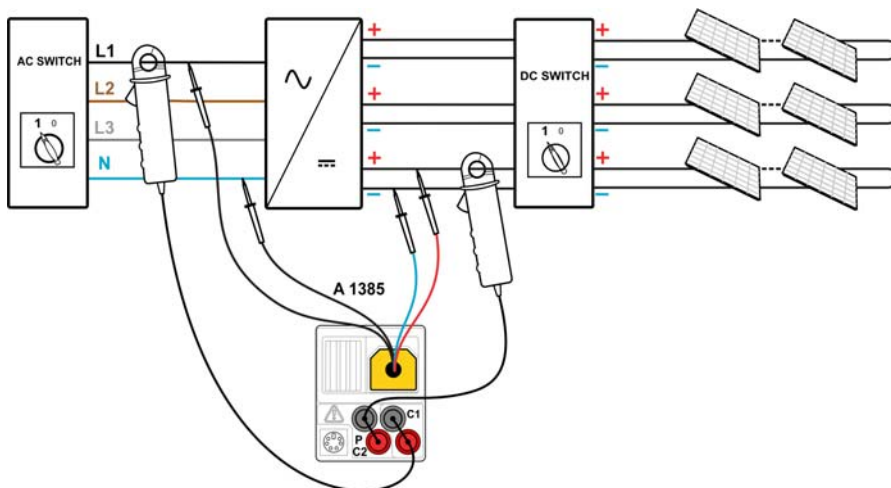

Figure 6.8: PV inverter test - AC and DC sides

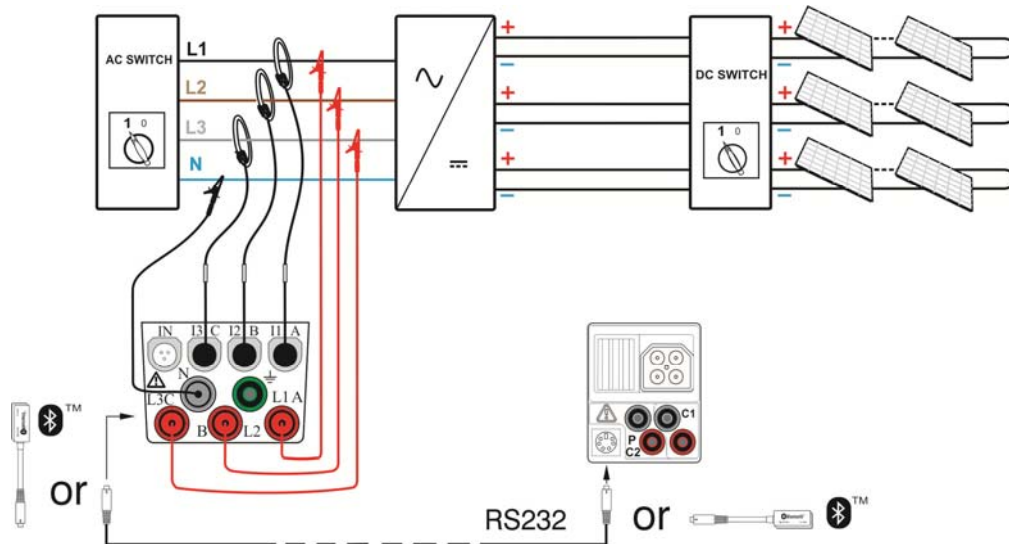

Figure 6.9: PV inverter test – 3 phase - AC side

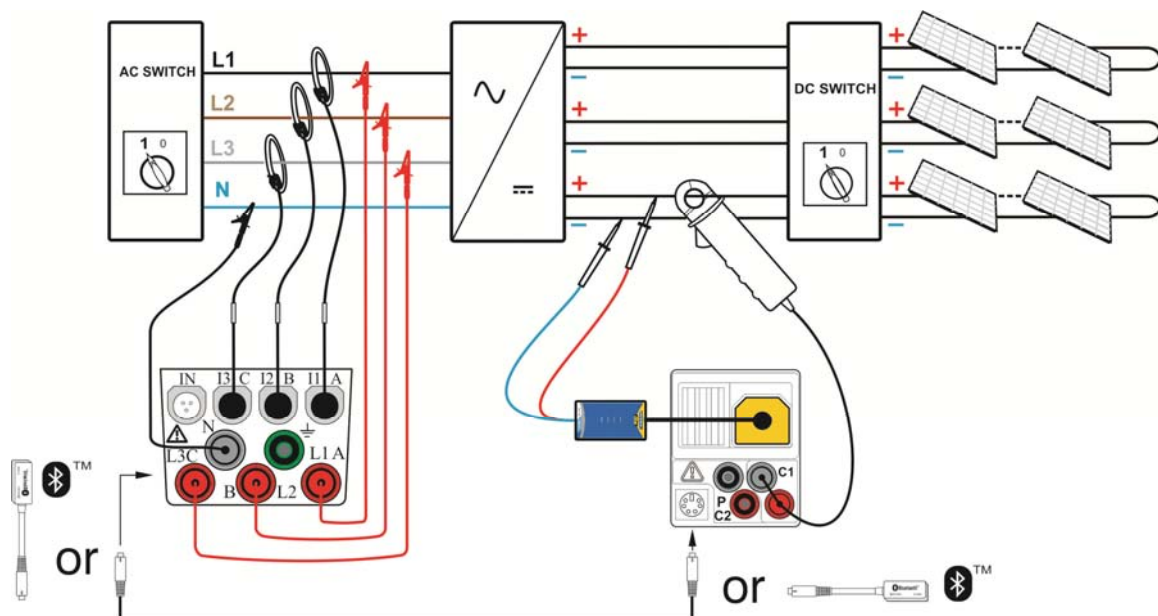

Figure 6.10: PV inverter test – 3 phase AC and DC sides

PV inverter test procedure (with EurotestPV instrument)

- ❑ Select **INVERTER** sub-function using the function selector keys and Δ/∇ keys.
- ❑ **Connect** PV safety probe and current clamp to the instrument (see figures 6.6 and 6.7) or
- ❑ **Connect** PV test lead A 1385 and current clamps to the instrument (see figure 6.8)
- ❑ **Connect** accessories to the PV system (see figures 6.6 to 6.8).
- ❑ Check input voltages.
- ❑ Press the **TEST** key to perform the measurement.
- ❑ **Store** the result by pressing the **MEM** key (optional).

PV inverter test procedure (with EurotestPV instrument and Metrel Powermeter)

Note:

- ❑ The Communication settings of Metrel Powermeter must be following:
Source = RS232
Baud Rate = 9600
- ❑ Select **INVERTER** sub-function using the function selector keys and \wedge/∇ keys.
- ❑ Be sure that the EurotestPV instrument and Powermeter are connected via serial cable or Bluetooth.
- ❑ **Connect** PV safety probe and DC current clamp to the EurotestPV instrument (see figures 6.9 and 6.10).
- ❑ **Connect** voltage test leads and AC current clamps to the Powermeter.
- ❑ **Connect** voltage test leads to L1, L2, L3 and N at the output side of the inverter (see figures 6.9 and 6.10).
- ❑ **Connect** accessories to the PV system (see figures 6.9 and 6.10).
- ❑ Check input voltages on the instrument and measurement results on the Powermeter (best to be in **Power measurements** menu).
- ❑ Press the **TEST** key to perform the measurement. Results from both instruments are displayed on the EurotestPV screen. A.C. measurement results in detail are displayed on Powermeter also.
- ❑ **Store** the result by pressing the **MEM** key (optional).

INVERTER: DC	
DC	
U	85.2 V
I	2.39 A
P	203 W
U: 85.2V	

INVERTER: AC	
AC	
U	104.1 V
I	1.14 A
P	119 W
U: 104V	

INVERTER: AC/DC			
DC		AC	
U	85.2 V	104.1 V	
I	2.39 A	1.14 A	
P	203 W	119 W	
η=58.4%		Udc: 97.7V	
		Uac: 104V	

Figure 6.11: Examples of PV inverter test results screens - 1 phase a.c. output

INVERTER: AC3		
AC		
Pt	198 W	
P1	66.1 W	
P2	66.1 W	
P3	65.8 W	

INVERTER: AC3/DC			
AC		DC	
Pt	198 W	P	203 W
P1	66.1 W	U	85.2 V
P2	66.1 W	I	2.39 A
P3	65.8 W		
η=97.5%		Udc: 97.7V	

Figure 6.12: Examples of PV inverter test results screens - 3 phase a.c. output

POWER METER				
	L1	L2	L3	Total
p	10.75	10.92	22.06	-0.39 kW
Q	18.69	-18.72	0.67	0.64 VAr
S	21.56	21.67	22.07	0.75 VA
pf	-0.49i	+0.50c	-0.99c	-0.52c
apf	-0.49i	+0.50c	-1.00c	
U	234.5	235.8	235.8	V
I	91.93	91.90	93.61	A
HOLD				

Figure 6.13: Example of Powermeter result screen - 3 phase a.c. output

Displayed results for PV inverter test:

DC column:

U.....measured voltage at the input of the inverter

I.....measured current at the input of the inverter

P.....measured power at the input of the inverter

AC column:

U.....measured voltage at the output of the inverter

I.....measured current at the output of the inverter

P.....measured power at the output of the inverter

AC (3 phase power) column

Pt.....measured total power at the output of the inverter

P1.....measured power of phase 1 at the output of the inverter

P2.....measured power of phase 2 at the output of the inverter

P3.....measured power of phase 3 at the output of the inverter

ηcalculated efficiency of the inverter

Notes:

- ❑ With one current clamp the complete test can be performed in two steps. Input should be set to **DC** and **AC** separately.
- ❑ For the INVERTER AC/DC test fused test lead A 1385 must be used!
- ❑ For more information about measuring and setup of the Metrel Powermeter refer to Metrel Powermeter’s instruction manual. Contact Metrel or distributor for detailed information which Metrel Powermeters are suitable for this measurement.

6.3 PV panel test

PV panel test is intended to check proper operation of PV panels. Following functions are supported:

- ❑ measuring of output voltage, current and power of PV panel,
- ❑ comparison of measured PV output values (MEAS values) and calculated nominal data (STC values)
- ❑ comparison of measured PV output power (Pmeas) and theoretical output power (Ptheo)

The PV panel test results are divided into three screens. See chapter 4.2 Function selection for instructions on key functionality. The input voltage is displayed in order to check proper connection before carrying out the test.

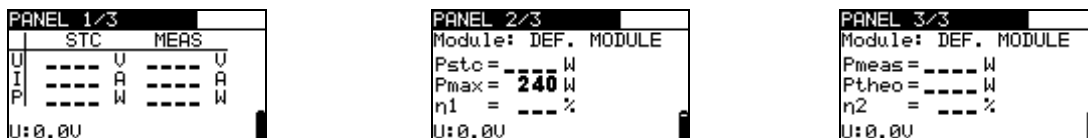

Figure 6.14: PV module test starting screens

Connections for PV panel

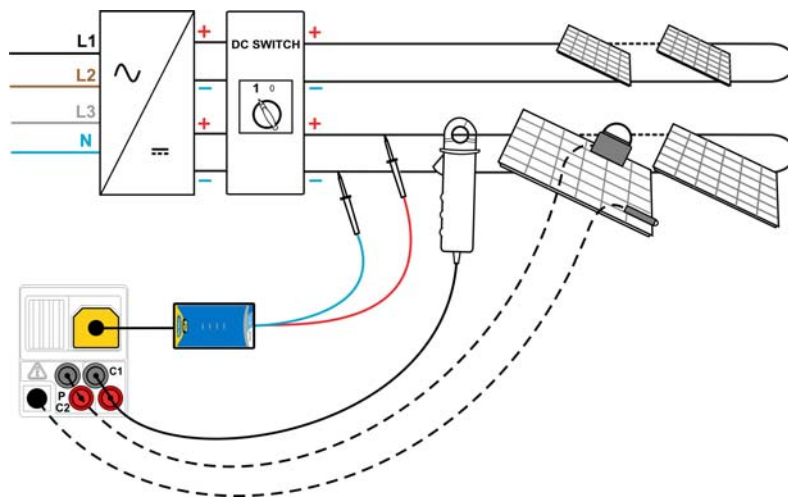

Figure 6.15: PV panel test

PV panel test procedure

- ❑ Select **PANEL** sub-function using the function selector keys.
- ❑ **Connect** PV safety probe, current clamp(s) and sensors to the instrument.
- ❑ **Connect** the PV system to be tested (see figure 6.15).
- ❑ Check input voltage.
- ❑ Press the **TEST** key to perform the test.
- ❑ **Store** the result by pressing the **MEM** key (optional).

PANEL 1/3		STC	MEAS
U	84.5 U	85.3 U	
I	2.94 A	2.44 A	
P	248 W	208 W	
U: 85.2V			

PANEL 2/3	
Module: DE	
Pstc	= 248 W
Pmax	= 240 W
η_1	= 100.0 %
U: 85.2V	

PANEL 3/3	
Module: DE	
Pmeas	= 208 W
Ptheo	= 209 W
η_2	= 99.4 %
U: 85.2V	

Figure 6.16: Examples of PV measurement results

Displayed results are:

MEAS column

U.....measured output voltage of the panel

I.....measured output current of the panel

P.....measured output power of the panel

STC column

U.....calculated output voltage of the panel at STC

I.....calculated output current of the panel at STC

P.....calculated output power of the panel at STC

Pstc.....measured output power of the panel at STC

Pmax..... nominal output power of the panel at STC

η_1efficiency of the panel at STC

- P_{meas}measured output power of the panel at momentary conditions
 P_{theo}calculated theoretical output power of the panel at momentary conditions
 η_2calculated efficiency of the panel at momentary conditions

Notes:

- Before starting the PV measurements settings of PV module type and PV test parameters should be checked.
- For calculation of STC results PV module type, PV test parameters, U_{oc} , I_{sc} , I_{rr} and T (ambient or cell) values must be measured or be entered manually before the test. The results in ENV. and U_{oc}/I_{sc} menus are considered. If there are no results in U_{oc}/I_{sc} menu the instrument will consider results in I-V menu.
- The U_{oc} , I_{sc} , I_{rr} and T measurements should be carried out immediately before the PANEL test. Environmental conditions must be stable during the tests.
- For best results PV remote unit A 1378 should be used.

6.4 Measuring of environmental parameters

Temperature and solar irradiance values must be known for:

- Calculation of nominal values at standard test conditions (STC),
- Checking that environmental conditions are suitable for carrying out the PV tests.

The parameters can be measured or entered manually. The probes can be connected to the instrument or to the PV remote unit A 1378.

See chapter 4.2 Function selection for instructions on key functionality.



Figure 6.17: Environmental parameters screen

Test parameters for measuring / setting of environmental parameters

INPUT	Input of environmental data [MEAS, MANUAL]
-------	---

Connections for measuring of environmental parameters

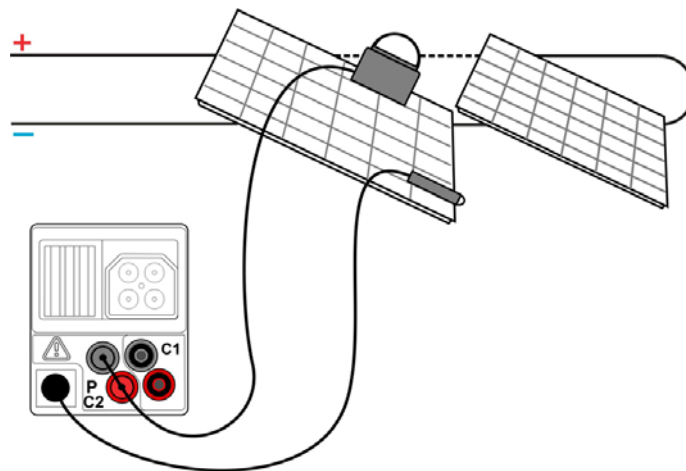

Figure 6.18: Measurement of environmental parameters

Procedure for measuring of environmental parameters

- ❑ Select **ENV.** function and **MEAS** sub-function using the function selector keys and $\blacktriangle/\blacktriangledown$ keys.
- ❑ **Connect** environmental probes to the instrument (see figure 6.18).
- ❑ **Connect** the item to be tested (see figure 6.13).
- ❑ Press the **TEST** key to perform the measurement.
- ❑ **Store** the result by pressing the **MEM** key (optional).

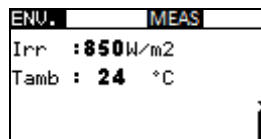

Figure 6.19: Example of measured results

Displayed results for environmental parameters:

- Irr.....solar irradiance
- Tamb or Tcell.... temperature of ambient or PV cells

Note:

- ❑ If the Irradiance result is lower than the set minimal value Irr min the STC results will not be calculated (message **Irr<Irr min!** is displayed).

Procedure for manual entering of environmental parameters

If the data is measured with other measuring equipment they can be entered manually. Select **ENV.** function and **MANUAL** sub-function using the function selector keys and Up/Down keys.

Keys:

TEST	Enters menu for manual setting of environmental parameters. Enters menu for changing selected parameter. Confirms set value of parameter.
$\blacktriangle / \blacktriangledown$	Selects environmental parameter.

	Selects value of parameter.
Function selector	Exits environmental menu and select PV measurement.

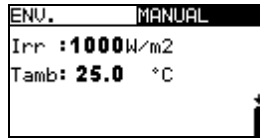

Figure 6.20: Example of manually entered results

Displayed results for environmental parameters:

- Irr.....solar irradiance
- Tamb or Tcell.... temperature of ambient or PV cells

Note:

- Environmental parameters are cleared when the SOLAR test mode is exited.

6.4.1 Operation with A1378 PV Remote Unit

See PV Remote Unit User Manual.

6.5 Uoc / Isc test

The Uoc / Isc test is intended to check if protection devices in the d.c. part of the PV installation are effective. The measured data can be calculated to nominal data (STC values).

See chapter 4.2 Function selection for instructions on key functionality.

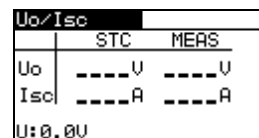

Figure 6.21: Uoc / Isc test

The input voltage is displayed in order to check proper connection before carrying out the test.

Connection for Uoc / Isc test

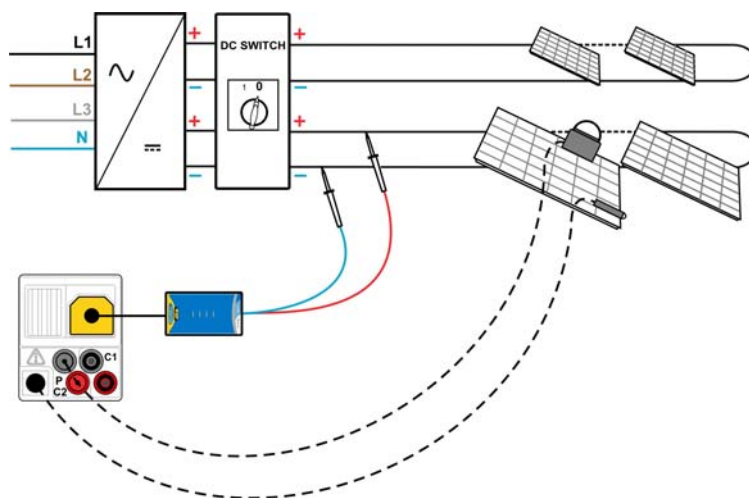

Figure 6.22: Uoc / Isc test

Uoc / Isc test procedure

- ❑ Select **Uoc / Isc** sub-function using the function selector keys and $\blacktriangle/\blacktriangledown$ keys.
- ❑ **Connect** PV safety probe and sensors (optional) to the instrument.
- ❑ **Connect** the item to be tested (see figure 6.22).
- ❑ Check input voltage.
- ❑ Press the **TEST** key to perform the measurement.
- ❑ **Store** the result by pressing the **MEM** key (optional).

Uo/IsC		STC	MEAS
Uo		112V	110V
Isc		5.29A	4.93A
U: 4.5V			

Figure 6.23: Example of Uoc / Isc measurement results

Displayed results for Uoc / Isc measurement:

MEAS column

Uoc.....measured open voltage of the panel

Isc.....measured short circuit current of the panel

STC column

Uoc.....calculated open voltage at STC

Isc.....calculated short circuit current at STC

Notes:

- ❑ Before starting the PV measurements settings of PV module type and PV test parameters should be checked.
- ❑ For calculation of STC results correct PV module type, PV test parameters, Irr and T (ambient or cell) values must be measured or be entered manually before the test. The Irr and T results in ENV. menu are considered. Refer to Appendix E for further information.
- ❑ The Irr and T measurements should be carried out immediately before the Uoc / Isc test. Environmental conditions must be stable during the tests.
- ❑ For best results PV remote unit A 1378 should be used.

6.6 I / V curve measurement

The I / V curve measurement is used to check correct operation of the PV panels. Different problems on PV panels (failure of a part of the PV panel / string, dirt, shadow etc.) can be found.

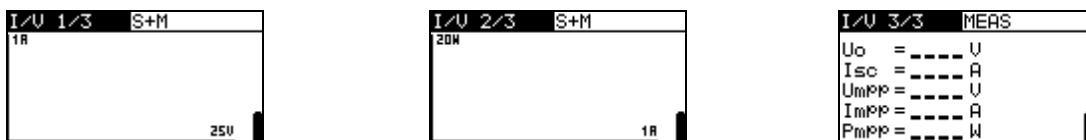

Figure 6.24: I / V curve starting screens

The data to be measured is divided into three screens. See chapter 4.2 Function selection for instructions on key functionality.

Settings parameters for I / V curve test

1/3	Number of screen.
STC	Results (STC, measured, both) to be displayed.

Connection for the I / V curve test

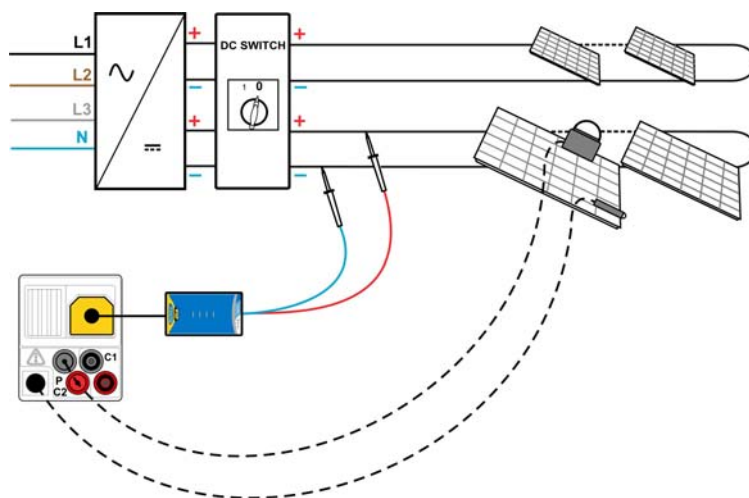

Figure 6.25: I / V curve test

I / V curve test procedure

- ❑ Select **I/V** sub-function using the function selector keys and $\blacktriangle/\blacktriangledown$ keys.
- ❑ Check or set PV module and PV testing parameters and limits (optional).
- ❑ **Connect** PV safety probe to the instrument.
- ❑ **Connect** environmental probes to the instrument (optional).
- ❑ **Connect** the item to be tested (see figure 6.25).
- ❑ Press the **TEST** key to perform the measurement.
- ❑ **Store** the result by pressing the **MEM** key (optional).



Figure 6.26: Example of I / V curve results

Displayed results for I / V curve test:

Uoc.....measured / STC open circuit voltage of the panel
 Isc.....measured / STC short circuit current of the panel
 Umpp.....measured / STC voltage at maximal power point
 Imppmeasured / STC current at maximal power point
 Pmpp.....measured / STC maximal output power of the panel

Notes:

- ❑ Before starting the PV measurements settings of PV module type and PV test parameters should be checked.
- ❑ For calculation of STC results correct PV module type, PV test parameters, Irr and T (ambient or cell) values must be measured or be entered manually before the test. The Irr. and T results in ENV. menu are considered. Refer to Appendix E for further information.
- ❑ The Irr. and T measurements should be carried out immediately before the I / V curve test. Environmental conditions must be stable during the tests.
- ❑ For best results PV remote unit A 1378 should be used.

7 Measurements - Power & Energy

1- phase power measurements and tests (sub-functions) can be performed with the EurotestPV instrument. Main features are:

- ❑ Measurement of standard power parameters,
- ❑ Harmonic analysis of voltage and current,
- ❑ Displaying of voltage and current waveforms,
- ❑ Energy counting.

7.1 Power

The Power function is intended to measure the standard power parameters P, Q, S, THDU and PF.

See chapter 4.2 Function selection for instructions on key functionality.



Figure 7.1: Power menu

Settings and parameters for Power test

There are no parameters to be set in this menu.

Connection for Power test

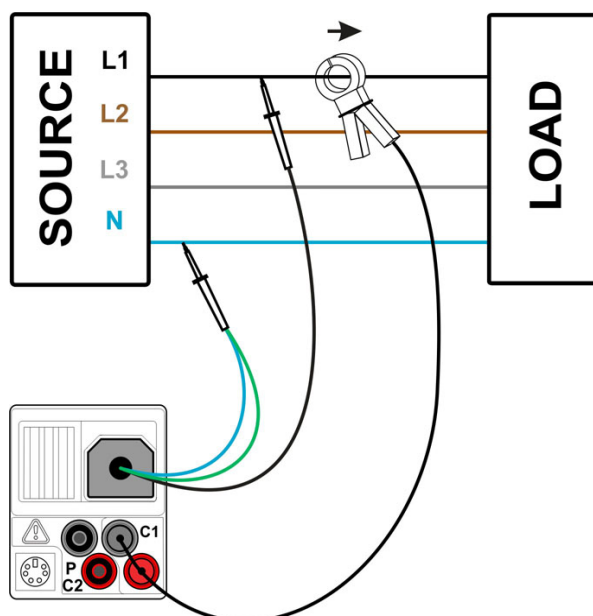

Figure 7.2: Power measurement

Power test procedure

- ❑ Select **POWER** sub-function using the function selector keys and $\blacktriangle/\blacktriangledown$ keys.
- ❑ **Connect** the voltage test leads and current clamp to the instrument.
- ❑ **Connect** the voltage test leads and current clamp to the item to be tested (see figure 7.2).
- ❑ Press the **TEST** key to start the continuous measurement.
- ❑ Press the **TEST** key again to stop the measurement.
- ❑ **Store** the result by pressing the **MEM** key (optional).

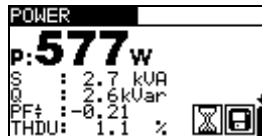

Figure 7.3: Power measurement results

Displayed results for the Power measurements:

P.....active power
 S.....apparent power
 Qreactive power (capacitive or inductive)
 PF..... power factor (capacitive or inductive)
 THDU.....voltage total harmonic distortion

Notes:

- ❑ Consider polarity and setup of current clamps (see chapter 4.4.8 *Clamp settings*).
- ❑ Results can also be stored while the measurement is running.

7.2 Harmonics

Harmonics are components of the voltage and currents signal with an integer multiple of the fundamental frequency. The harmonic values are an important parameter of power quality.

See chapter 4.2 Function selection for instructions on key functionality.



Figure 7.4: Harmonics menu

Settings and parameters in Harmonics function

Input	Displayed parameters [voltage U or current I]
h:0 h:11	Selected harmonic

Connection for the Harmonics measurement

(See figure 7.2)

Harmonics measurement procedure

- ❑ Select **HARMONICS** sub-function using the function selector keys and Δ/∇ keys.
- ❑ **Connect** voltage test leads and current clamp to the instrument.
- ❑ **Connect** the voltage test leads and current clamp to the item to be tested (see figure 7.2).
- ❑ Press the **TEST** key to start the continuous measurement.
- ❑ Press the **TEST** key again to stop the measurement.
- ❑ **Store** the result by pressing the **MEM** key (optional)



Figure 7.5: Examples of Harmonics measurement results

Displayed results for the Harmonics measurements:

- Uh..... TRMS voltage of selected harmonic
- Ih TRMS current of selected harmonic
- THDU.....voltage total harmonic distortion
- THDI.....voltage total harmonic distortion

Notes:

- ❑ Parameters (input and number of harmonic) can be changed and results can also be stored while the measurement is running.
- ❑ Displayed graph is auto-ranged.

7.3 Scope

The Scope function is intended to check the shape of voltage and current.

See chapter 4.2 Function selection for instructions on key functionality.



Figure 7.6: Scope menu

Settings and parameters in Scope function

Input	Displayed parameters [voltage U or current I or both]
-------	--

Connection for the Scope measurement

(See figure 7.2)

Scope measurement procedure

- ❑ Select **SCOPE** sub-function using the function selector keys and Up/Down keys.
- ❑ **Connect** voltage test leads and current clamp to the instrument.
- ❑ **Connect** the voltage test leads and current clamp to the item to be tested (see figure 7.2).
- ❑ Press the **TEST** key to start the continuous measurement.
- ❑ Press the **TEST** key again to stop the measurement.
- ❑ **Store** the result by pressing the **MEM** key (optional)



Figure 7.7: Example of Scope measurement results

TRMS values of voltage and current are displayed.

Notes:

- ❑ The parameter input can be changed and results can also be stored while the measurement is running.
- ❑ Displayed waveforms are auto-ranged.

7.4 Current

This function is intended for measurement of load and leakage currents with current clamps. Two independent measuring inputs are available.

See chapter 4.2 Function selection for instructions on key functionality.

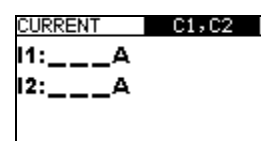

Figure 7.8: Current menu

Settings and parameters for current measurement

Input	Selected channel [C1, C2, both]
-------	---------------------------------

Connection for current measurement

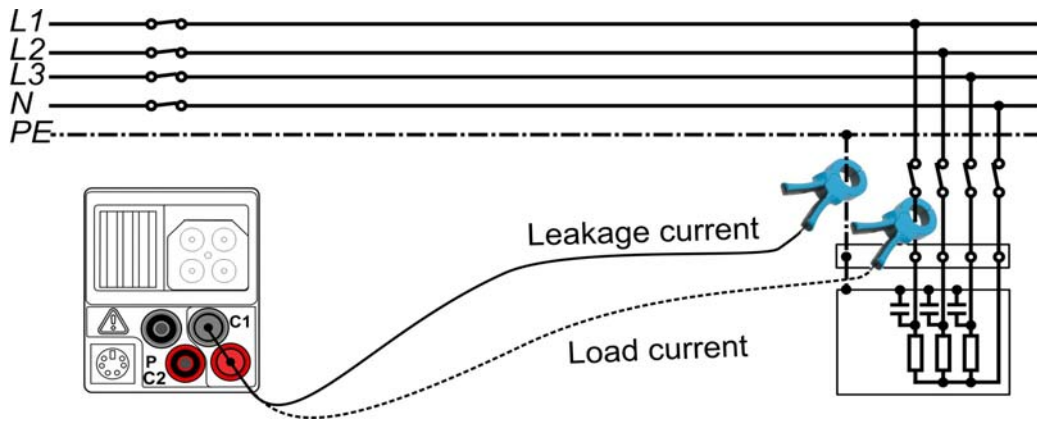

Figure 7.9: Leakage and load current measurements

Current measurement procedure

- ❑ Select **CURRENT** function using the function selector keys.
- ❑ Select input channel (optional).
- ❑ **Connect** current clamp(s) to the instrument.
- ❑ **Connect** the clamp(s) to the item to be tested (see figure 7.9).
- ❑ Press the **TEST** key to start the continuous measurement.
- ❑ Press the **TEST** key again to stop the measurement.
- ❑ **Store** the result by pressing the **MEM** key (optional).

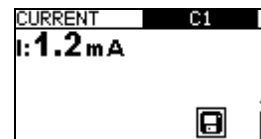
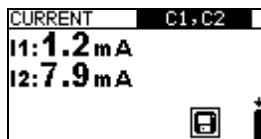

Figure 7.10: Examples of current measurement result

Displayed results for Current measurement:

I, I1, I2Current

Note:

- ❑ Channel C2 is intended for measuring with clamps A 1391 only.

7.5 Energy

In this function consumed and generated energy can be measured.

See chapter 4.2 Function selection for instructions on key functionality.

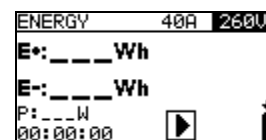

Figure 7.11: Energy menu

Settings and parameters for the Energy measurement

I_{MAX}	Maximal expected TRMS current during measurement [I_{range} , $I_{range}/10$, $I_{range}/100$]
U_{MAX}	Maximal expected TRMS voltage during measurement [260 V, 500 V]

Connection for the Energy measurements

(See figure 7.2)

Energy measurement procedure

- ❑ Select **ENERGY** sub-function using the function selector keys and $\blacktriangle/\blacktriangledown$ keys.
- ❑ **Connect** the voltage test leads and current clamp to the instrument.
- ❑ **Connect** the voltage test leads and current clamp to the item to be tested (see figure 7.2).
- ❑ Press the **TEST** key to start the measurement.
- ❑ Press the **TEST** key again to stop the measurement.
- ❑ **Store** the result by pressing the **MEM** key (optional).



Figure 7.12: Example of Energy measurement results

Displayed results for the Energy measurements:

- E+.....consumed energy (load)
- E-.....generated energy (source)
- P.....momentary active power during energy measurement
- t..... time

Notes:

- ❑ Consider polarity and setup of current clamps (see chapter 4.4.8 *Clamp settings*).
- ❑ I_{MAX} and U_{MAX} should be set high enough in order to avoid clamping of measured signals. Clamping will result in wrong energy result.
- ❑ If measured currents and voltages are lower than 20% of set I_{MAX} , U_{MAX} the accuracy will be impaired.

8 Data handling

8.1 Memory organization

Measurement results together with all relevant parameters can be stored in the instrument's memory. After the measurement is completed, results can be stored to the flash memory of the instrument, together with the sub-results and function parameters.

8.2 Data structure

The instrument's memory place is divided into 4 levels each containing 199 locations. The number of measurements that can be stored into one location is not limited.

The **data structure field** describes the location of the measurement (which object, block, fuse, connection) and where can be accessed.

In the **measurement field** there is information about type and number of measurements that belong to the selected structure element (object and block and fuse and connection).

The main advantages of this system are:

- Test results can be organized and grouped in a structured manner that reflects the structure of typical electrical installations.
- Customized names of data structure elements can be uploaded from EurolinkPRO PCSW.
- Simple browsing through structure and results.
- Test reports can be created with no or little modifications after downloading results to a PC.

RECALL RESULTS
[OBJ]OBJECT 004
[BLK]BLOCK 001
[FUS]FUSE 002
[CON]CONNECTION 003
> No. : 3/3
VOLTAGE TRMS

Figure 8.1: Data structure and measurement fields

Data structure field

RECALL RESULTS	Memory operation menu
[OBJ]OBJECT 004 [BLK]BLOCK 001 [FUS]FUSE 002 [CON]CONNECTION 003	Data structure field
[OBJ]OBJECT 004	<ul style="list-style-type: none"> □ 1st level: OBJECT: Default location name (object and its successive number). 004: No. of selected element.
[BLK]BLOCK 001	<ul style="list-style-type: none"> □ 2nd level: BLOCK: Default location name (block and its successive number). 001: No. of selected element.
[FUS]FUSE 002	<ul style="list-style-type: none"> □ 3rd level: FUSE: Default location name (fuse and its successive number). □ 002: No. of selected element.
[CON]CONNECTION 003	<ul style="list-style-type: none"> □ 4th level: CONNECTION: Default location name (connection and its successive number). 003: No. of selected element.
No. : 20 [112]	No. of measurements in selected location [No. of measurements in selected location and its sub-locations]
Measurement field	
VOLTAGE TRMS	Type of stored measurement in the selected location.
> No. : 3/3	No. of selected test result / No. of all stored test results in selected location.

8.3 Storing test results

After the completion of a test the results and parameters are ready for storing (💾 icon is displayed in the information field). By pressing the **MEM** key, the user can store the results.

```

Save results
[ob.]OBJECT 004
[blc]BLOCK 001
[fus]FUSE 002
> [com]CONNECTION 003
FREE: 95.3%
MEM : SAVE
  
```

Figure 8.2: Save test menu

Memory free: 99.6% Memory available for storing results.

Keys in save test menu - data structure field:

TAB	Selects the location element (Object / Block / Fuse / Connection)
UP / DOWN	Selects number of selected location element (1 to 199)
MEM	Saves test results to the selected location and returns to the measuring menu.
Function selector / TEST	Exits back to main function menu.

Notes:

- ❑ The instrument offers to store the result to the last selected location by default.
- ❑ If the measurement is to be stored to the same location as the previous one just press the **MEM** key twice.

8.4 Recalling test results

Press the **MEM** key in a main function menu when there is no result available for storing or select **MEMORY** in the **SETTINGS** menu.

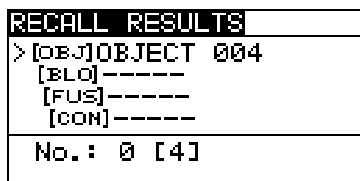

Figure 8.3: Recall menu - installation structure field selected

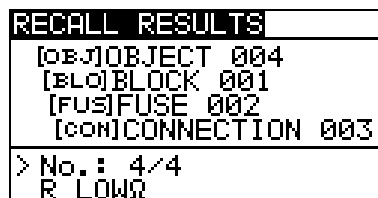

Figure 8.4: Recall menu - measurements field selected

Keys in recall memory menu (installation structure field selected):

TAB	Selects the location element (Object / Block / Fuse / Connection).
UP / DOWN	Selects number of selected location element (1 to 199)
Function selector / ESC	Exits back to main function menu.
TEST	Enters measurements field.

Keys in recall memory menu (measurements field):

UP / DOWN	Selects the stored measurement.
TAB / ESC	Returns to installation structure field.
Function selector	Exits back to main function menu.
TEST	View selected measurement results.

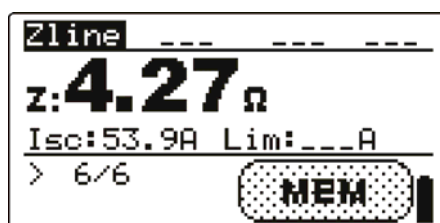

Figure 8.5: Example of recalled measurement result

Keys in recall memory menu (measurement results are displayed)

UP / DOWN	Displays measurement results stored in selected location
MEM / ESC	Returns to measurements field.
Function selector / TEST	Exits back to main function menu.

8.5 Clearing stored data

8.5.1 Clearing complete memory content

Select **CLEAR ALL MEMORY** in **MEMORY** menu. A warning will be displayed.

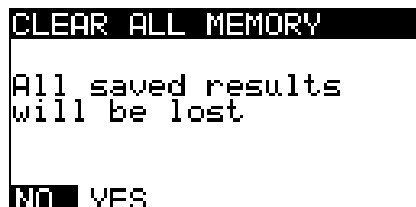

Figure 8.6: Clear all memory

Keys in clear all memory menu

TEST	Confirms clearing of complete memory content (YES must be selected with ▲/▼ keys).
Function selector	Exits back to main function menu without changes.

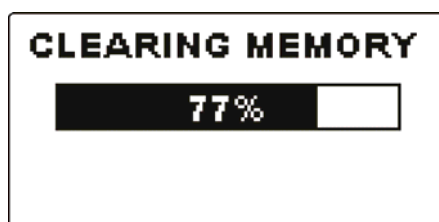

Figure 8.7: Clearing memory in progress

8.5.2 Clearing measurement(s) in selected location

Select **DELETE RESULTS** in **MEMORY** menu.

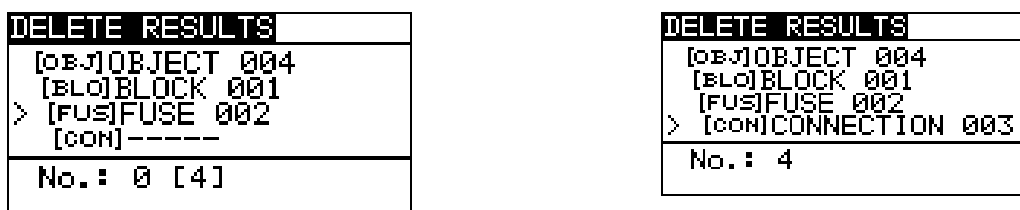

Figure 8.8: Clear measurements menu (data structure field selected)

Keys in delete results menu (installation structure field selected):

TAB	Selects the location element (Object / Block / Fuse / Connection).
UP / DOWN	Selects number of selected location element (1 to 199)
Function selector	Exits back to main function menu.
ESC	Exits back to memory menu.
TEST	Enters dialog box for deleting all measurements in selected location and its sub-locations.

Keys in dialog for confirmation to clear results in selected location:

TEST	Deletes all results in selected location.
MEM / ESC	Exits back to delete results menu without changes.
Function selector	Exits back to main function menu without changes.

8.5.3 Clearing individual measurements

Select **DELETE RESULTS** in **MEMORY** menu.

DELETE RESULTS
[OB]OBJECT 004
[BL]BLOCK 001
[FUS]FUSE 002
[CON]CONNECTION 003
> No. : 4/4
R LOWΩ

Figure 8.9: Menu for clearing individual measurement (installation structure field selected)

Keys in delete results menu (installation structure field selected):

TAB	Selects the location element (Object / Block / Fuse / Connection).
UP / DOWN	Selects number of selected location element (1 to 199)
Function selector	Exits back to main function menu.
ESC	Exits back to memory menu.
MEM	Enters measurements field for deleting individual measurements.

Keys in delete results menu (measurements field selected):

UP / DOWN	Selects measurement.
TEST	Opens dialog box for confirmation to clear selected measurement.
TAB / ESC	Returns to installation structure field.
Function selector	Exits back to main function menu without changes.

Keys in dialog for confirmation to clear selected result(s):

TEST	Deletes selected measurement result.
MEM / TAB / ESC	Exits back to measurements field without changes.
Function selector	Exits back to main function menu without changes.

DELETE RESULTS
[OB]OBJECT 004
[BL]BLOCK 001
[FUS]FUSE 002
[CON]CONNECTION 003
> No. : 3/4
CLEAR RESULT?

Figure 8.10: Dialog for confirmation

DELETE RESULTS
[OB]OBJECT 004
[BL]BLOCK 001
[FUS]FUSE 002
[CON]CONNECTION 003
> No. : 3/3
R LOWΩ

Figure 8.11: Display after measurement was cleared

8.5.4 Renaming installation structure elements (upload from PC)

Default installation structure elements are “Object”, “Block”, “Fuse” and “Connection”. In the PCSW package Eurolink-PRO default names can be changed with customized names that corresponds the installation under test. Refer to PCSW Eurolink-PRO HELP for information how to upload customized installation names to the instrument.

RECALL RESULTS
[OBJ]OBJECT LC
[BLK]B_FLOOR2
[FUS]F_F2C
> [CON]S_F2C_03
No. : 3

Figure 8.12: Example of menu with customized installation structure names

8.5.5 Renaming installation structure elements with serial barcode reader or RFID reader

Default installation structure elements are “Object”, “Block”, “Fuse” and “Connection”. When the instrument is in the Save results menu location ID can be scanned from a barcode label with the barcode reader or can be read from a RFID tag with the RFID reader.

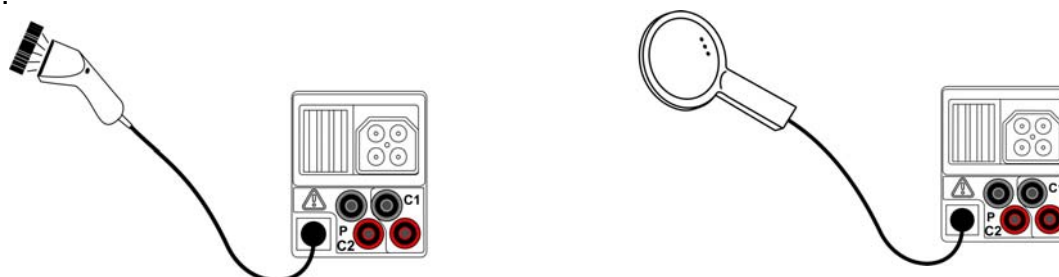

Figure 8.13: Connection of the barcode reader and RFID reader

How to change the name of memory location

- ❑ Connect the barcode reader or RFID reader to the instrument.
- ❑ Make sure that RS232 is selected in Communication menu.
- ❑ In Save menu select memory location to be renamed.
- ❑ A new location name (scanned from a barcode label or a RFID tag) will be accepted by the instrument. A successful receive of a barcode or RFID tag is confirmed by two short confirmation beeps.

Note:

- ❑ Use only barcode readers and RFID readers delivered by Metrel or authorized distributor.

8.6 Communication

There are two communication interfaces available on the instrument: USB or RS 232. With the optional Bluetooth dongle A 1436 the instrument can communicate via Bluetooth too.

8.6.1 USB and RS232 communication

The instrument automatically selects the communication mode according to detected interface. USB interface has priority.

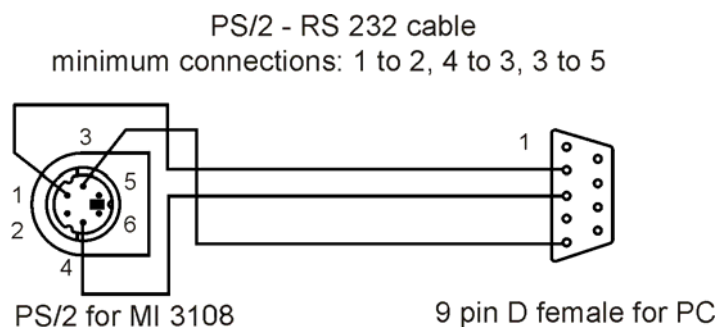

Figure 8.14: Interface connection for data transfer over PC COM port

How to configure a USB link between instrument and PC

- ❑ Connect a PC USB port to the instrument USB connector using the USB interface cable.
- ❑ Switch **on** the PC and the instrument.
- ❑ **Run** the *EuroLinkPRO* program.
- ❑ The PC and the instrument will automatically recognize each other.
- ❑ The instrument is prepared to communicate with the PC.

How to configure a RS232 link between instrument and PC

- ❑ Connect a PC COM port to the instrument PS/2 connector using the PS/2 - RS232 serial communication cable;
- ❑ Switch **on** the PC and the instrument.
- ❑ Set communication settings to RS232.
- ❑ **Run** the *EuroLinkPRO* program.
- ❑ Set COM port and baud rate.
- ❑ The instrument is prepared to communicate with the PC.

The program *EuroLinkPRO* is a PC software running on Windows XP, Windows Vista, Windows 7, and Windows 8. Read the file README_EuroLink.txt on CD for instructions about installing and running the program.

Notes:

- ❑ USB drivers should be installed on PC before using the USB interface. Refer to USB installation instructions available on installation CD.
- ❑ The RS232 port supports other services too (for example upgrading the instrument, connections of sensors, adapters, etc).

8.6.2 Bluetooth communication

How to configure a Bluetooth link between instrument and PC

For Bluetooth communication with PC a Standard Serial Port over Bluetooth link for Bluetooth dongle A 1436 must be configured first.

- ❑ Switch Off and On the instrument.
- ❑ Be sure that the Bluetooth dongle A 1436 is properly initialized. If not the Bluetooth dongle must be initialized as described in chapter 4.4.7 *Communication*.
- ❑ On PC configure a Standard Serial Port to enable communication over Bluetooth link between instrument and PC. Usually no code for pairing the devices is needed.
- ❑ Run the *EurolinkPRO* program.
- ❑ The PC and the instrument will automatically recognize each other.
- ❑ The instrument is prepared to communicate with the PC.

How to configure a Bluetooth link between instrument and Android device

- ❑ Switch Off and On the instrument.
- ❑ Be sure that the Bluetooth dongle A 1436 is properly initialized. If not the Bluetooth dongle must be initialized as described in chapter 4.4.7 *Communication*.
- ❑ Some Android applications automatically carry out the setup of a Bluetooth connection. It is preferred to use this option if it exists.
This option is supported by Metrel's Android applications.
- ❑ If this option is not supported by the selected Android application then configure a Bluetooth link via Android device's Bluetooth configuration tool. Usually no code for pairing the devices is needed.
- ❑ The instrument and Android device are ready to communicate.

How to configure a Bluetooth link between EurotestPV instrument and Metrel Powermeter

- ❑ Switch Off and On the EurotestPV instrument.
- ❑ Be sure that the EurotestPV Bluetooth dongle A 1436 is connected and properly initialized. If not the Bluetooth dongle must be initialized as described in chapter 4.4.7 *Communication*.
- ❑ Switch On the Metrel Powermeter. A second Bluetooth dongle A 1436 should be inserted to the Powermeter's PS/2 port.
- ❑ Be sure that the second Bluetooth dongle A 1436 is properly initialized (as PowerQ device). If not the Bluetooth dongle must be initialized as described in chapter 4.4.7 *Communication*.
- ❑ The settings in instrument's Communication menu (see chapter 4.4.7 *Communication*) should be as following:
COM PORT: BT DONGLE
BLUETOOTH DEVICES: PowerQ

- | |
|--|
| <ul style="list-style-type: none">□ The EurotestPV instrument and Powermeter are ready to communicate. |
|--|

Notes:

- Sometimes there will be a demand from the PC or Android device to enter the code. Enter code 'NNNN' to correctly configure the Bluetooth link.
- The name of a correctly configured Bluetooth device must consist of the instrument type plus serial number, eg. *MI 3108-12240429D*. If the Bluetooth dongle got another name, the configuration must be repeated.

9 Upgrading the instrument

The instrument can be upgraded from a PC via the RS232 communication port. This enables to keep the instrument up to date even if the standards or regulations change. The upgrade can be carried with a help of special upgrading software and the communication cable as shown on *Figure 8.14*. Please contact your dealer for more information.

10 Maintenance

Unauthorized persons are not allowed to open the EurotestPV instrument. There are no user replaceable components inside the instrument, except the battery and fuse under rear cover.

10.1 Fuse replacement

There is a fuse under back cover of the EurotestPV instrument.

- F1
FF 315 mA / 1000 V d.c. , 32×6 mm (Breaking capacity: 50 kA)
This fuse protects internal circuitry for continuity functions if test probes are connected to the mains supply voltage by mistake during measurement.
Position of fuse can be seen in *Figure 3.4* in chapter 3.3 *Back panel*.

Optional accessory A 1385 PV test lead has replaceable fuse in each test lead.

- FF 315 mA / 1000 V d.c. , 32×6 mm (Breaking capacity: 50 kA)

Warnings:

-  **Disconnect all measuring accessory and switch off the instrument before opening battery / fuse compartment cover, hazardous voltage inside!**
- Replace blown fuse with original type only, otherwise the instrument or accessory may be damaged and/or operator's safety impaired!

10.2 Cleaning

No special maintenance is required for the housing. To clean the surface of the instrument or accessory use a soft cloth slightly moistened with soapy water or alcohol. Then leave the instrument or accessory to dry totally before use.

Warnings:

- Do not use liquids based on petrol or hydrocarbons!
- Do not spill cleaning liquid over the instrument!

10.3 Periodic calibration

It is essential that the test instrument is regularly calibrated in order that the technical specification listed in this manual is guaranteed. We recommend an annual calibration. Only an authorized technical person can do the calibration. Please contact your dealer for further information.

10.4 Service

For repairs under warranty, or at any other time, please contact your distributor.

11 Technical specifications

11.1 Insulation resistance, Insulation resistance of PV systems

Insulation resistance (nominal voltages 50 V_{DC}, 100 V_{DC} and 250 V_{DC})

Measuring range according to EN 61557 is 0.15 MΩ ÷ 199.9 MΩ.

Measuring range (MΩ)	Resolution (MΩ)	Accuracy
0.00 ÷ 19.99	0.01	±(5 % of reading + 3 digits)
20.0 ÷ 99.9	0.1	±(10 % of reading)
100.0 ÷ 199.9		±(20 % of reading)

Insulation resistance (nominal voltages 500 V_{DC} and 1000 V_{DC})

Measuring range according to EN 61557 is 0.15 MΩ ÷ 1 GΩ.

Measuring range (MΩ)	Resolution (MΩ)	Accuracy
0.00 ÷ 19.99	0.01	±(5 % of reading + 3 digits)
20.0 ÷ 199.9	0.1	±(5 % of reading)
200 ÷ 999	1	±(10 % of reading)

Voltage

Measuring range (V)	Resolution (V)	Accuracy
0 ÷ 1200	1	±(3 % of reading + 3 digits)

Nominal voltages50 V_{DC}, 100 V_{DC}, 250 V_{DC}, 500 V_{DC}, 1000 V_{DC}

Open circuit voltage-0 % / +20 % of nominal voltage

Measuring current.....min. 1 mA at R_N=U_N×1 kΩ/V

Short circuit current..... max. 3 mA

The number of possible tests..... > 1200, with a fully charged battery

Auto discharge after test.

Specified accuracy is valid if 3-wire test lead is used while it is valid up to 100 MΩ if tip commander is used.

Specified accuracy is valid up to 100 MΩ if relative humidity > 85 %.

In case the instrument gets moistened, the results could be impaired. In such case, it is recommended to dry the instrument and accessories for at least 24 hours.

The error in operating conditions could be at most the error for reference conditions (specified in the manual for each function) ±5 % of measured value.

11.2 Continuity

11.2.1 Resistance R LOW Ω

Measuring range according to EN 61557 is 0.16 Ω ÷ 1999 Ω .

Measuring range R (Ω)	Resolution (Ω)	Accuracy
0.00 ÷ 19.99	0.01	$\pm(3\%$ of reading + 3 digits)
20.0 ÷ 199.9	0.1	$\pm(5\%$ of reading)
200 ÷ 1999	1	

Open-circuit voltage6.5 VDC ÷ 9 VDC
 Measuring currentmin. 200 mA into load resistance of 2 Ω
 Test lead compensationup to 5 Ω
 The number of possible tests> 2000, with a fully charged battery
 Automatic polarity reversal of the test voltage.

11.2.2 Resistance CONTINUITY

Measuring range (Ω)	Resolution (Ω)	Accuracy
0.0 ÷ 19.9	0.1	$\pm(5\%$ of reading + 3 digits)
20 ÷ 1999	1	

Open-circuit voltage6.5 VDC ÷ 9 VDC
 Short-circuit currentmax. 8.5 mA
 Test lead compensationup to 5 Ω

11.3 RCD testing

11.3.1 General data

Nominal residual current (A,AC) 10 mA, 30 mA, 100 mA, 300 mA, 500 mA, 1000 mA
 Nominal residual current accuracy.....-0 / +0.1 \cdot I Δ N; I Δ = I Δ N, 2 \times I Δ N, 5 \times I Δ N
 -0.1 \cdot I Δ / +0; I Δ = 0.5 \times I Δ N
 AS/NZS selected: $\pm 5\%$
 Test current shapeSine-wave (AC), pulsed (A, F), smooth DC (B, B+)
 DC offset for pulsed test current6 mA (typical)
 RCD type(non-delayed), S (time-delayed)
 Test current starting polarity 0° or 180°
 Voltage range93 V ÷ 134 V (45 Hz ÷ 65 Hz)
 185 V ÷ 266 V (45 Hz ÷ 65 Hz)

I Δ N (mA)	I Δ N \times 1/2			I Δ N \times 1			I Δ N \times 2			I Δ N \times 5			RCD I Δ		
	AC	A,F	B, B+	AC	A,F	B,B+	AC	A,F	B,B+	AC	A,F	B,B+	AC	A,F	B,B+
10	5	3.5	5	10	20	20	20	40	40	50	100	100	✓	✓	✓
30	15	10.5	15	30	42	60	60	84	120	150	212	300	✓	✓	✓
100	50	35	50	100	141	200	200	282	400	500	707	1000	✓	✓	✓
300	150	105	150	300	424	600	600	848	n.a.	1500	n.a.	n.a.	✓	✓	✓
500	250	175	250	500	707	1000	1000	1410	n.a.	2500	n.a.	n.a.	✓	✓	✓
1000	500	350	500	1000	1410	n.a.	2000	n.a.	n.a.	n.a.	n.a.	n.a.	✓	✓	n.a.

n.a.....not applicable
 AC type.....sine wave test current
 A, F types.....pulsed current
 B, B+ typessmooth DC current

11.3.2 Contact voltage RCD-Uc

Measuring range according to EN 61557 is 20.0 V ÷ 31.0V for limit contact voltage 25V
 Measuring range according to EN 61557 is 20.0 V ÷ 62.0V for limit contact voltage 50V

Measuring range (V)	Resolution (V)	Accuracy
0.0 ÷ 19.9	0.1	(-0 % / +15 %) of reading ± 10 digits
20.0 ÷ 99.9	0.1	(-0 % / +15 %) of reading

The accuracy is valid if mains voltage is stable during the measurement and PE terminal is free of interfering voltages.

Test current max. $0.5 \times I_{\Delta N}$
 Limit contact voltage 25 V, 50 V
 Specified accuracy is valid for complete operating range.

11.3.3 Trip-out time

Complete measurement range corresponds to EN 61557 requirements.
 Maximum measuring times set according to selected reference for RCD testing.

Measuring range (ms)	Resolution (ms)	Accuracy
0.0 ÷ 40.0	0.1	±1 ms
0.0 ÷ max. time *	0.1	±3 ms

* For max. time see normative references in chapter 4.4.4 RCD standard – this specification applies to max. time >40 ms.

Test current $\frac{1}{2} \times I_{\Delta N}$, $I_{\Delta N}$, $2 \times I_{\Delta N}$, $5 \times I_{\Delta N}$
 $5 \times I_{\Delta N}$ is not available for $I_{\Delta N} = 1000$ mA (RCD type AC) or $I_{\Delta N} \geq 300$ mA (RCD types A, F, B, B+).
 $2 \times I_{\Delta N}$ is not available for $I_{\Delta N} = 1000$ mA (RCD types A, F) or $I_{\Delta N} \geq 300$ mA (RCD types B, B+).
 $1 \times I_{\Delta N}$ is not available for $I_{\Delta N} = 1000$ mA (RCD types B, B+).
 Specified accuracy is valid for complete operating range.

11.3.4 Trip-out current

Trip-out current
 Complete measurement range corresponds to EN 61557 requirements.

Measuring range I_{Δ}	Resolution I_{Δ}	Accuracy
$0.2 \times I_{\Delta N} \div 1.1 \times I_{\Delta N}$ (AC type)	$0.05 \times I_{\Delta N}$	$\pm 0.1 \times I_{\Delta N}$
$0.2 \times I_{\Delta N} \div 1.5 \times I_{\Delta N}$ (A type, $I_{\Delta N} \geq 30$ mA)	$0.05 \times I_{\Delta N}$	$\pm 0.1 \times I_{\Delta N}$
$0.2 \times I_{\Delta N} \div 2.2 \times I_{\Delta N}$ (A type, $I_{\Delta N} < 30$ mA)	$0.05 \times I_{\Delta N}$	$\pm 0.1 \times I_{\Delta N}$
$0.2 \times I_{\Delta N} \div 2.2 \times I_{\Delta N}$ (B type)	$0.05 \times I_{\Delta N}$	$\pm 0.1 \times I_{\Delta N}$

Trip-out time

Measuring range (ms)	Resolution (ms)	Accuracy
0 ÷ 300	1	±3 ms

Contact voltage

Measuring range (V)	Resolution (V)	Accuracy
0.0 ÷ 19.9	0.1	(-0 % / +15 %) of reading ± 10 digits
20.0 ÷ 99.9	0.1	(-0 % / +15 %) of reading

The accuracy is valid if mains voltage is stable during the measurement and PE terminal is free of interfering voltages.

Trip-out measurement is not available for $I_{\Delta N}=1000$ mA (RCD types B, B+).

Specified accuracy is valid for complete operating range.

11.4 Fault loop impedance and prospective fault current

11.4.1 No disconnecting device or FUSE selected

Fault loop impedance

Measuring range according to EN 61557 is 0.25 Ω ÷ 9.99k Ω .

Measuring range (Ω)	Resolution (Ω)	Accuracy
0.00 ÷ 9.99	0.01	±(5 % of reading + 5 digits)
10.0 ÷ 99.9	0.1	
100 ÷ 999	1	± 10 % of reading
1.00 k ÷ 9.99 k	10	

Prospective fault current (calculated value)

Measuring range (A)	Resolution (A)	Accuracy
0.00 ÷ 9.99	0.01	Consider accuracy of fault loop resistance measurement
10.0 ÷ 99.9	0.1	
100 ÷ 999	1	
1.00 k ÷ 9.99 k	10	
10.0 k ÷ 23.0 k	100	

The accuracy is valid if mains voltage is stable during the measurement.

Test current (at 230 V)..... 6.5 A (10 ms)

Nominal voltage range..... 93 V ÷ 134 V (45 Hz ÷ 65 Hz)

185 V ÷ 266 V (45 Hz ÷ 65 Hz)

11.4.2 RCD selected

Fault loop impedance

Measuring range according to EN 61557 is 0.46 Ω ÷ 9.99 k Ω .

Measuring range (Ω)	Resolution (Ω)	Accuracy
0.00 ÷ 9.99	0.01	±(5 % of reading + 10 digits)
10.0 ÷ 99.9	0.1	
100 ÷ 999	1	± 10 % of reading
1.00 k ÷ 9.99 k	10	

Accuracy may be impaired in case of heavy noise on mains voltage.

Prospective fault current (calculated value)

Measuring range (A)	Resolution (A)	Accuracy
0.00 ÷ 9.99	0.01	Consider accuracy of fault loop resistance measurement
10.0 ÷ 99.9	0.1	
100 ÷ 999	1	
1.00 k ÷ 9.99 k	10	
10.0 k ÷ 23.0 k	100	

Nominal voltage range..... 93 V ÷ 134 V (45 Hz ÷ 65 Hz)
185 V ÷ 266 V (45 Hz ÷ 65 Hz)

No trip out of RCD.

11.5 Line impedance and prospective short-circuit current / Voltage drop

Line impedance

Measuring range according to EN 61557 is 0.25 Ω ÷ 9.99kΩ.

Measuring range (Ω)	Resolution (Ω)	Accuracy
0.00 ÷ 9.99	0.01	±(5 % of reading + 5 digits)
10.0 ÷ 99.9	0.1	
100 ÷ 999	1	± 10 % of reading
1.00 k ÷ 9.99 k	10	

Prospective short-circuit current (calculated value)

Measuring range (A)	Resolution (A)	Accuracy
0.00 ÷ 0.99	0.01	Consider accuracy of line resistance measurement
1.0 ÷ 99.9	0.1	
100 ÷ 999	1	
1.00 k ÷ 99.99 k	10	
100 k ÷ 199 k	1000	

Test current (at 230 V)..... 6.5 A (10 ms)

Nominal voltage range..... 93 V ÷ 134 V (45 Hz ÷ 65 Hz)
185 V ÷ 266 V (45 Hz ÷ 65 Hz)
321 V ÷ 485 V (45 Hz ÷ 65 Hz)

Voltage drop (calculated value)

Measuring range (%)	Resolution (%)	Accuracy
0.0 ÷ 99.9	0.1	Consider accuracy of line impedance measurement(s)*

Z_{REF} measuring range.....0.00 Ω ÷ 20.0 Ω

*See chapter 5.6.2 *Voltage drop* for more information about calculation of voltage drop result

11.6 Resistance to earth

Measuring range according to EN61557-5 is $2.00 \Omega \div 1999 \Omega$.

Measuring range (Ω)	Resolution (Ω)	Accuracy
0.00 \div 19.99	0.01	$\pm(5\%$ of reading + 5 digits)
20.0 \div 199.9	0.1	
200 \div 9999	1	

Max. auxiliary earth electrode resistance R_C ... $100 \times R_E$ or $50 \text{ k}\Omega$ (whichever is lower)

Max. probe resistance R_P $100 \times R_E$ or $50 \text{ k}\Omega$ (whichever is lower)

Additional probe resistance error at R_{Cmax} or R_{Pmax} . $\pm(10 \%$ of reading + 10 digits)

Additional error

at 3 V voltage noise (50 Hz) $\pm(5 \%$ of reading + 10 digits)

Open circuit voltage $< 15 \text{ VAC}$

Short circuit current..... $< 30 \text{ mA}$

Test voltage frequency 125 Hz

Test voltage shape sine wave

Noise voltage indication threshold $1 \text{ V} (< 50 \Omega, \text{ worst case})$

Automatic measurement of auxiliary electrode resistance and probe resistance.

Automatic measurement of voltage noise.

11.7 Voltage, frequency, and phase rotation

11.7.1 Phase rotation

Nominal system voltage range $100 \text{ V}_{AC} \div 550 \text{ V}_{AC}$

Nominal frequency range..... $14 \text{ Hz} \div 500 \text{ Hz}$

Result displayed 1.2.3 or 3.2.1

11.7.2 Voltage

Measuring range (V)	Resolution (V)	Accuracy
0 \div 550	1	$\pm(2 \%$ of reading + 2 digits)

Result type..... True r.m.s. (trms)

Nominal frequency range..... $0 \text{ Hz}, 14 \text{ Hz} \div 500 \text{ Hz}$

11.7.3 Frequency

Measuring range (Hz)	Resolution (Hz)	Accuracy
0.00 \div 9.99	0.01	$\pm(0.2 \%$ of reading + 1 digit)
10.0 \div 499.9	0.1	

Nominal voltage range..... $10 \text{ V} \div 550 \text{ V}$

11.7.4 Online terminal voltage monitor

Measuring range (V)	Resolution (V)	Accuracy
10 ÷ 550	1	±(2 % of reading + 2 digits)

11.8 TRMS Clamp current**Instrument**

Maximum voltage on C1 and P/C2 measuring inputs...3 V

Nominal frequency..... 0 Hz, 40 Hz ÷ 500 Hz

AC current clamp A1018

Range = 20 A

Measuring range (A)	Resolution (A)	Accuracy*
0.0 m ÷ 99.9 m	0.1 m	±(5 % of reading + 5 digits)
100 m ÷ 999 m	1 m	±(3 % of reading + 3 digits)
1.00 ÷ 19.99	0.01	±(3 % of reading)

Range = 200 A

Measuring range (A)	Resolution (A)	Accuracy*
0.00 ÷ 0.09	0.01	indicative
0.10 ÷ 19.99	0.01	±(3 % of reading + 3 digits)
20.0 ÷ 199.9	0.1	±(3 % of reading)

AC current clamp A1019

Range = 20 A

Measuring range (A)	Resolution (A)	Accuracy*
0.0 m ÷ 99.9 m	0.1 m	indicative
100 m ÷ 999 m	1 m	±(5 % of reading)
1.00 ÷ 19.99	0.01	±(3 % of reading)

Range = 200 A

Measuring range (A)	Resolution (A)	Accuracy*
0.00 ÷ 0.09	0.01	indicative
0.10 ÷ 1.99	0.01	±(5 % of reading + 3 digits)
2.00 ÷ 19.99	0.01	±(3 % of reading + 3 digits)
20.0 ÷ 199.9	0.1	±(3 % of reading)

AC / DC current clamp A1391

Range = 40 A

Measuring range (A)	Resolution (A)	Accuracy*
0.00 ÷ 1.99	0.01	±(3 % of reading + 3 digits)
2.00 ÷ 19.99	0.01	±(3 % of reading)
20.0 ÷ 39.9	0.1	±(3 % of reading)

Range = 300 A

Measuring range (A)	Resolution (A)	Accuracy*
0.00 ÷ 19.99	0.01	indicative
20.0 ÷ 39.9	0.1	
40.0 ÷ 299.9	0.1	±(3 % of reading + 5 digits)

* Accuracy at operating conditions for instrument and current clamp is given.

11.9 Power tests

Measurement characteristics

Function symbols	Class according to IEC 61557-12	Measuring range
P E	2.5	5 % ÷ 100 % $I_{Nom}^{(1)}$
Q	2.5	5 % ÷ 100 % $I_{Nom}^{(1)}$
S	2.5	5 % ÷ 100 % $I_{Nom}^{(1)}$
PF	1	- 1 ÷ 1
f	0.05	40 Hz ÷ 60 Hz
I, I_{Nom}	1.5	5 % ÷ 100 % I_{Nom}
U	1.5	110 V ÷ 500 V
U_{h_n}	2.5	0 % ÷ 20 % U_{Nom}
THD _u	2.5	0 % ÷ 20 % U_{Nom}
I_{h_n}	2.5	0 % ÷ 100 % I_{Nom}
THD _i	2.5	0 % ÷ 100 % I_{Nom}

⁽¹⁾ – I_{Nom} depends on set current sensor type and selected current range:

- A 1018, A1019 (20 A or 200 A),
- A 1391 (40 A or 300 A)

Note:

- Error of external voltage and current transducers is not considered in this specification.

Power (P, S, Q)

Measuring range is from 0.00 W (VA, Var) to 99.9 kW (kVA, kVar)

Power factor

Measuring range is from – 1.00 to 1.00

Voltage harmonics

Measuring range is from 0.1 V to 500 V

Voltage THD

Measuring range is from 0.1 % to 99.9 %

Current harmonics and Current THD

Measuring range is from 0.00 A to 199.9 A

Energy

Measuring range is from 0.000 Wh to 1999 kWh

Measurement is performed continuously without gaps.

Notes:

- Error of external voltage and current transducers is not considered in this specification.
- Accuracy values for Energy are valid if $I > 0.2 I_{MAX}$. I_{MAX} is set in ENERGY measuring menu.

11.10 PV tests**11.10.1 Accuracy of STC data**

Accuracy of STC values is based on accuracy of measured electrical quantities, accuracy of environmental parameters, and entered parameters of PV module. See *Appendix E: PV measurements – calculated values* for more information about calculation of STC values.

11.10.2 Panel, Inverter**DC Voltage**

Measuring range (V)	Resolution (V)	Accuracy
0.0 ÷ 199.9	0.1	± (1.5 % of reading + 5 digits)
200 ÷ 999	1	±1.5 % of reading

DC Current

Measuring range (A)	Resolution (mA)	Accuracy
0.00 ÷ 19.99	10	±(1.5 % of reading + 5 digits)
20.0 ÷ 299.9	100	±1.5 % of reading

DC Power

Measuring range (W)	Resolution (W)	Accuracy
0 – 1999	1	± (2.5 % of reading + 6 digits)
2.00 k ÷ 19.99 k	10	±2.5 % of reading
20.0 k ÷ 199.9 k	100	±2.5 % of reading

AC Voltage

Measuring range (V)	Resolution (V)	Accuracy
0.0 ÷ 99.9	0.1	± (1.5 % of reading + 3 digits)
100.0 ÷ 199.9	0.1	±1.5 % of reading
200 ÷ 999	1	±1.5 % of reading

AC Current

Measuring range (A)	Resolution (mA)	Accuracy
0.00 ÷ 9.99	10	±(1.5 % of reading + 3 digits)
10.00 ÷ 19.99	10	±1.5 % of reading
20.0 ÷ 299.9	100	±1.5 % of reading

AC Power

Measuring range (W)	Resolution (W)	Accuracy
0 – 1999	1	± (2.5 % of reading + 6 digits)
2.00 k ÷ 19.99 k	10	±2.5 % of reading
20.0k ÷ 199.9 k	100	±2.5 % of reading

Notes:

- Error of external voltage and current transducers is not considered in this specification.
- For measuring range, resolution and accuracy of the 3-phase a.c. powers (Pt, P1, P2 and P3) in AC3 and AC3/DC inverter sub-functions refer to technical specifications of applied Metrel Powermeter.

11.10.3 I-V curve**DC Voltage**

Measuring range (V)	Resolution (V)	Accuracy
0.0 ÷ 15.0	0.1	indicative
15.1 ÷ 199.9	0.1	± (2 % of reading + 2 digits)
200 ÷ 999	1	±2 % of reading

DC Current

Measuring range (A)	Resolution (A)	Accuracy
0.00 ÷ 9.99	0.01	±(2 % of reading + 3 digits)
10.00 ÷ 15.00	0.01	±2 % of reading

DC Power

Measuring range (W)	Resolution (W)	Accuracy
0 – 1999	1	± (3 % of reading + 5 digits)
2.00 k ÷ 14.99 k	10	± 3 % of reading

Maximal power of PV string: 15 kW

11.10.4 Uoc - Isc**DC Voltage**

Measuring range (V)	Resolution (V)	Accuracy
0.0 ÷ 15.0	0.1	indicative
15.1 ÷ 199.9	0.1	± (2 % of reading + 2 digits)
200 ÷ 999	1	±2 % of reading

DC Current

Measuring range (A)	Resolution (A)	Accuracy
0.00 ÷ 9.99	0.01	±(2 % of reading + 3 digits)
10.00 ÷ 15.00	0.01	±2 % of reading

Maximal power of PV string: 15 kW

11.10.5 Environmental parameters

Solar Irradiance

Probe A 1399

Measuring range (W/m ²)	Resolution (W/m ²)	Accuracy
300 ÷ 999	1	± (5 % of reading + 5 digits)
1000 ÷ 1999	1	± 5 % of reading

Measuring principle: Pyranometer

Operation conditions:

Working temperature range -40 °C ÷ 55 °C

Designed for continuous outdoor use.

Probe A 1427

Measuring range	Resolution (W/m ²)	Accuracy
0 ÷ 999 W/m ²	1	± (4 % + 5 digits)
1.00 ÷ 1.75 kW/m ²	10	± 4 %

Measuring principle: Monocrystall PV cell, temperature compensated

Operation conditions:

Working temperature range -20 °C ÷ 55 °C

Protection degree IP 44

Temperature (cell and ambient)

Probe A 1400

Measuring range (°C)	Resolution (°C)	Accuracy
-10.0 ÷ 85.0	0.1	± 5 digits

Designed for continuous outdoor use.

Note:

- Given accuracy is valid for stable irradiance and temperature during the test.

11.10.6 Insulation Resistance of PV systems

Refer to chapter 11.1. *Insulation Resistance, Insulation Resistance of PV systems.*

11.11 General data

Power supply voltage 9 V_{DC} (6×1.5 V battery or accu, size AA)

Operation typical 20 h

Charger socket input voltage 12 V ± 10 %

Charger socket input current 400 mA max.

Battery charging current 250 mA (internally regulated)

Measuring category	1000 V DC CAT II 600 V CAT III 300 V CAT IV
Protection classification	double insulation
Pollution degree.....	2
Protection degree	IP 40
Display	128x64 dots matrix display with backlight
Dimensions (w × h × d)	23 cm × 10.3 cm × 11.5 cm
Weight	1.3 kg, without battery cells

Reference conditions

Reference temperature range.....	10 °C ÷ 30 °C
Reference humidity range.....	40 %RH ÷ 70 %RH

Operation conditions

Working temperature range	0 °C ÷ 40 °C
Maximum relative humidity	95 %RH (0 °C ÷ 40 °C), non-condensing

Storage conditions

Temperature range	-10 °C ÷ +70 °C
Maximum relative humidity	90 %RH (-10 °C ÷ +40 °C) 80 %RH (40 °C ÷ 60 °C)

Communication transfer speed:

RS 232	57600 baud
RS 232 wireless.....	9600 baud
USB	256000 baud

Size of memory:

I-V curve, Power (Scope): ca. 500 measurements

Other measurements: ca 1800 measurements

The error in operating conditions could be at most the error for reference conditions (specified in the manual for each function) +1 % of measured value + 1 digit, unless otherwise specified in the manual for particular function.

Appendix A – Fuse table

A.1 Fuse table – IPSC

Fuse type NV

Rated current (A)	Disconnection time [s]				
	35m	0.1	0.2	0.4	5
	Min. prospective short-circuit current (A)				
2	32.5	22.3	18.7	15.9	9.1
4	65.6	46.4	38.8	31.9	18.7
6	102.8	70	56.5	46.4	26.7
10	165.8	115.3	96.5	80.7	46.4
16	206.9	150.8	126.1	107.4	66.3
20	276.8	204.2	170.8	145.5	86.7
25	361.3	257.5	215.4	180.2	109.3
35	618.1	453.2	374	308.7	169.5
50	919.2	640	545	464.2	266.9
63	1217.2	821.7	663.3	545	319.1
80	1567.2	1133.1	964.9	836.5	447.9
100	2075.3	1429	1195.4	1018	585.4
125	2826.3	2006	1708.3	1454.8	765.1
160	3538.2	2485.1	2042.1	1678.1	947.9
200	4555.5	3488.5	2970.8	2529.9	1354.5
250	6032.4	4399.6	3615.3	2918.2	1590.6
315	7766.8	6066.6	4985.1	4096.4	2272.9
400	10577.7	7929.1	6632.9	5450.5	2766.1
500	13619	10933.5	8825.4	7515.7	3952.7
630	19619.3	14037.4	11534.9	9310.9	4985.1
710	19712.3	17766.9	14341.3	11996.9	6423.2
800	25260.3	20059.8	16192.1	13545.1	7252.1
1000	34402.1	23555.5	19356.3	16192.1	9146.2
1250	45555.1	36152.6	29182.1	24411.6	13070.1

Fuse type gG

Rated current (A)	Disconnection time [s]				
	35m	0.1	0.2	0.4	5
	Min. prospective short-circuit current (A)				
2	32.5	22.3	18.7	15.9	9.1
4	65.6	46.4	38.8	31.9	18.7
6	102.8	70	56.5	46.4	26.7
10	165.8	115.3	96.5	80.7	46.4
13	193.1	144.8	117.9	100	56.2
16	206.9	150.8	126.1	107.4	66.3
20	276.8	204.2	170.8	145.5	86.7
25	361.3	257.5	215.4	180.2	109.3
32	539.1	361.5	307.9	271.7	159.1
35	618.1	453.2	374	308.7	169.5
40	694.2	464.2	381.4	319.1	190.1

50	919.2	640	545	464.2	266.9
63	1217.2	821.7	663.3	545	319.1
80	1567.2	1133.1	964.9	836.5	447.9
100	2075.3	1429	1195.4	1018	585.4

Fuse type B

Rated current (A)	Disconnection time [s]				
	35m	0.1	0.2	0.4	5
	Min. prospective short-circuit current (A)				
6	30	30	30	30	30
10	50	50	50	50	50
13	65	65	65	65	65
15	75	75	75	75	75
16	80	80	80	80	80
20	100	100	100	100	100
25	125	125	125	125	125
32	160	160	160	160	160
40	200	200	200	200	200
50	250	250	250	250	250
63	315	315	315	315	315

Fuse type C

Rated current (A)	Disconnection time [s]				
	35m	0.1	0.2	0.4	5
	Min. prospective short-circuit current (A)				
0.5	5	5	5	5	2.7
1	10	10	10	10	5.4
1.6	16	16	16	16	8.6
2	20	20	20	20	10.8
4	40	40	40	40	21.6
6	60	60	60	60	32.4
10	100	100	100	100	54
13	130	130	130	130	70.2
15	150	150	150	150	83
16	160	160	160	160	86.4
20	200	200	200	200	108
25	250	250	250	250	135
32	320	320	320	320	172.8
40	400	400	400	400	216
50	500	500	500	500	270
63	630	630	630	630	340.2

Fuse type K

Rated current (A)	Disconnection time [s]				
	35m	0.1	0.2	0.4	
	Min. prospective short-circuit current (A)				
0.5	7.5	7.5	7.5	7.5	
1	15	15	15	15	

1.6	24	24	24	24	
2	30	30	30	30	
4	60	60	60	60	
6	90	90	90	90	
10	150	150	150	150	
13	195	195	195	195	
15	225	225	225	225	
16	240	240	240	240	
20	300	300	300	300	
25	375	375	375	375	
32	480	480	480	480	

Fuse type D

Rated current (A)	Disconnection time [s]				
	35m	0.1	0.2	0.4	5
	Min. prospective short-circuit current (A)				
0.5	10	10	10	10	2.7
1	20	20	20	20	5.4
1.6	32	32	32	32	8.6
2	40	40	40	40	10.8
4	80	80	80	80	21.6
6	120	120	120	120	32.4
10	200	200	200	200	54
13	260	260	260	260	70.2
15	300	300	300	300	81
16	320	320	320	320	86.4
20	400	400	400	400	108
25	500	500	500	500	135
32	640	640	640	640	172.8

A.2 Fuse table – Impedances at 230 V a.c. (AS/NZS 3017)

Type B

Rated current (A)	Disconnection time [s]	
	0.4	
	Max. loop impedance (Ω)	
6	9.58	
10	5.75	
16	3.59	
20	2.88	
25	2.30	
32	1.80	
40	1.44	
50	1.15	
63	0.91	
80	0.72	
100	0.58	
125	0.46	
160	0.36	
200	0.29	

Type C

Rated current (A)	Disconnection time [s]	
	0.4	
	Max. loop impedance (Ω)	
6	5.11	
10	3.07	
16	1.92	
20	1.53	
25	1.23	
32	0.96	
40	0.77	
50	0.61	
63	0.49	
80	0.38	
100	0.31	
125	0.25	
160	0.19	
200	0.15	

Type D

Rated current (A)	Disconnection time [s]	
	0.4	
	Max. loop impedance (Ω)	
6	3.07	
10	1.84	
16	1.15	
20	0.92	
25	0.74	
32	0.58	
40	0.46	
50	0.37	
63	0.29	
80	0.23	
100	0.18	
125	0.15	
160	0.12	
200	0.09	

Fuse

Rated current (A)	Disconnection time [s]	
	0.4	5
	Max. loop impedance (Ω)	
6	11.50	15.33
10	6.39	9.20
16	3.07	5.00
20	2.09	3.59
25	1.64	2.71
32	1.28	2.19
40	0.96	1.64
50	0.72	1.28
63	0.55	0.94
80	0.38	0.68
100	0.27	0.48
125	0.21	0.43
160	0.16	0.30
200	0.13	0.23

All impedances are scaled with factor 1.00

Appendix B – Accessories for specific measurements

The table below presents recommended standard and optional accessories required for specific measurement. Please see attached list of standard accessories for your set or contact your distributor for further information.

Function	Suitable accessories (Optional with ordering code A....)
Insulation resistance	<input type="checkbox"/> Test lead, 3 x 1.5 m <input type="checkbox"/> Tip commander (A 1401)
R LOW Ω resistance Continuity	<input type="checkbox"/> Test lead, 3 x 1.5 m <input type="checkbox"/> Tip commander (A 1401) <input type="checkbox"/> Test lead, 4 m (A 1012)
Line impedance Voltage Drop Fault loop impedance	<input type="checkbox"/> Test lead, 3 x 1.5 m <input type="checkbox"/> Plug commander (A 1314) <input type="checkbox"/> Mains measuring cable <input type="checkbox"/> Tip commander (A 1401) <input type="checkbox"/> Three-phase adapter with switch (A 1111)
RCD testing	<input type="checkbox"/> Test lead, 3 x 1.5 m <input type="checkbox"/> Plug commander (A 1314) <input type="checkbox"/> Mains measuring cable <input type="checkbox"/> Three-phase adapter with switch (A 1111)
Earth resistance, RE	<input type="checkbox"/> Test lead, 3 x 1.5 m <input type="checkbox"/> Earth test set, 3-wire, 20 m (S 2026) <input type="checkbox"/> Earth test set, 3-wire, 50 m (S 2027)
Phase sequence	<input type="checkbox"/> Test lead, 3 x 1.5 m <input type="checkbox"/> Three-phase adapter (A 1110) <input type="checkbox"/> Three-phase adapter with switch (A 1111)
Voltage, frequency	<input type="checkbox"/> Test lead, 3 x 1.5 m <input type="checkbox"/> Plug commander (A 1314) <input type="checkbox"/> Mains measuring cable <input type="checkbox"/> Tip commander (A 1401)
Power Energy Harmonics Scope	<input type="checkbox"/> Test lead, 3 x 1.5 m <input type="checkbox"/> Mains measuring cable <input type="checkbox"/> Tip commander (A 1401) <input type="checkbox"/> AC current clamp (A 1018) <input type="checkbox"/> AC current clamp (A 1019) <input type="checkbox"/> AC/ DC current clamp (A 1391)
Current	<input type="checkbox"/> AC current clamp (A 1018) <input type="checkbox"/> AC current clamp (A 1019) <input type="checkbox"/> AC/DC current clamp (A 1391)
Panel Isc / Uoc I/V curve	<input type="checkbox"/> PV Safety probe <input type="checkbox"/> PV MC 4 adapters <input type="checkbox"/> PV MC3 adapters <input type="checkbox"/> AC/ DC current clamp (A1391) <input type="checkbox"/> PV Remote unit (A 1378)
Inverter	<input type="checkbox"/> PV Safety probe <input type="checkbox"/> PV MC 4 adapters

	<ul style="list-style-type: none">❑ PV MC3 adapters❑ PV Remote unit (A 1378)❑ PV fused test lead (A 1385)❑ AC/DC current clamp (A 1391)❑ AC current clamp (A 1018)❑ AC current clamp (A 1019)
Insulation resistance PV	<ul style="list-style-type: none">❑ PV Safety probe
Environment	<ul style="list-style-type: none">❑ Temperature probe (A 1400)❑ Pyranometer (A 1399)❑ Monocrystal PV cell (A 1427)❑ PV Remote unit (A 1378)

Appendix C – Country notes

This appendix C contains collection of minor modifications related to particular country requirements. Some of the modifications mean modified listed function characteristics related to main chapters and others are additional functions. Some minor modifications are related also to different requirements of the same market that are covered by various suppliers.

C.1 List of country modifications

The following table contains current list of applied modifications.

Country	Related chapters	Modification type	Note
AT	5.4, 11.3, C.2.1	Appended	Special G type RCD
AUS / NZ	4.4, 4.4.5, 4.4.8, 5.5, 5.6, C.2.2, Appendix A	Appended	AUS / NZ fuse table added

C.2 Modification issues







C.2.1 AT modification - G type RCD

Modified is the following related to the mentioned in the chapter 5.4:

- Added G type RCD,
- Time limits are the same as for general type RCD,
- Contact voltage is calculated the same as for general type RCD.

Modifications of the chapter 5.4

Test parameters for RCD test and measurement

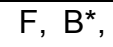
TEST	RCD sub-function test [RCDt, RCD I, AUTO, Uc].
$I_{\delta n}$	Rated RCD residual current sensitivity $I_{\Delta N}$ [10 mA, 30 mA, 100 mA, 300 mA, 500 mA, 1000 mA].
type	RCD type AC, A, F, B*, B+* starting polarity [ ,  ,  ,  ,  ,  ,  , selective <input type="checkbox"/> S, general <input type="checkbox"/> □, delayed <input type="checkbox"/> G characteristic.
MUL	Multiplication factor for test current [$\frac{1}{2}$, 1, 2, 5 $I_{\delta n}$].
Ulim	Conventional touch voltage limit [25 V, 50 V].

Notes:

- Ulim can be selected in the Uc sub-function only.
- Selective (time delayed) RCDs and RCDs with (G) - time delayed characteristic demonstrate delayed response characteristics. They contain residual current integrating mechanism for generation of delayed trip out. However, contact voltage pre-test in the measuring procedure also influences the RCD and it takes a period to recover into idle state. Time delay of 30 s is inserted before

performing trip-out test to recover S type RCD after pre-tests and time delay of 5 s is inserted for the same purpose for G type RCD.

Modification of the chapter 5.4.1

RCD type		Contact voltage U_c proportional to	Rated $I_{\Delta N}$
AC	<input type="checkbox"/> , <input type="checkbox"/> G	$1.05 \times I_{\Delta N}$	any
AC	<input type="checkbox"/> S	$2 \times 1.05 \times I_{\Delta N}$	
A,F	<input type="checkbox"/> , <input type="checkbox"/> G	$1.4 \times 1.05 \times I_{\Delta N}$	≥ 30 mA
A,F	<input type="checkbox"/> S	$2 \times 1.4 \times 1.05 \times I_{\Delta N}$	
A,F	<input type="checkbox"/> , <input type="checkbox"/> G	$2 \times 1.05 \times I_{\Delta N}$	< 30 mA
A,F	<input type="checkbox"/> S	$2 \times 2 \times 1.05 \times I_{\Delta N}$	
B, B+	<input type="checkbox"/>	$2 \times 1.05 \times I_{\Delta N}$	any
B, B+	<input type="checkbox"/> S	$2 \times 2 \times 1.05 \times I_{\Delta N}$	

Table C.1: Relationship between U_c and $I_{\Delta N}$

Technical specifications remain the same.

C.2.2 AUS / NZ modification – Fuse types according to AS/NZS 3017

Modifications of the chapter 4.4

I_{SC} factor is replaced with Z factor.

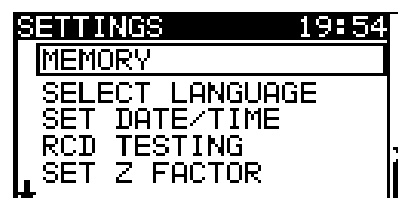

Figure C.1: Options in Settings menu

Modifications of the chapter 4.4.5

C.2.2.1 Z Factor

In this menu the Z factor can be set.

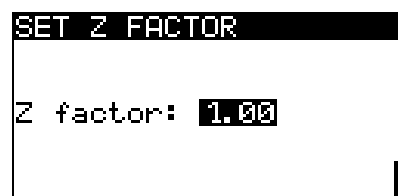

Figure C.2: Selection of Z factor

Keys:

UP / DOWN	Sets Z value.
TEST	Confirms Z value.
Function selectors	Exits back to main function menu.

The impedance limit values for different overcurrent protective devices depend on nominal voltage and are calculated using the Z factor. Z factor 1.00 is used for nominal voltage 230 V and Z factor 1.04 is used for nominal voltage 240 V.

Modifications of the chapter 4.4.8

The default setup is listed below:

Instrument setting	Default value
Z factor	1.00
RCD standards	AS/NZS 3017

Modifications of the chapter 5.5

Modified test parameters for fault loop impedance measurement

Fuse type	Selection of fuse type [---, FUSE, B, C, D]
Lim	High limit fault loop impedance value for selected fuse.

See Appendix A.2 for reference fuse data.

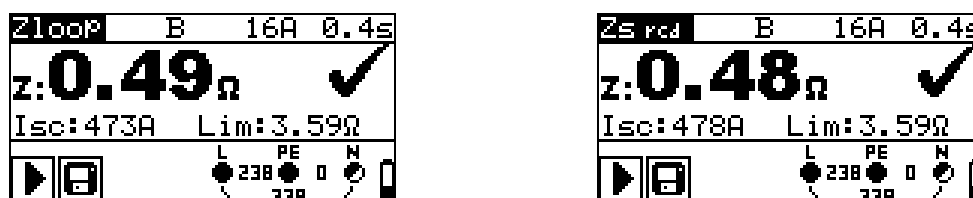

Figure C.3: Examples of loop impedance measurement result

Displayed results:

- Z** fault loop impedance
- Isc**prospective fault current,
- Lim**high limit fault loop impedance value.

Prospective fault current I_{PFC} is calculated from measured impedance as follows:

$$I_{PFC} = \frac{U_N}{Z_{L-PE} \cdot \text{scaling_factor}}$$

where:

- U_n Nominal U_{L-PE} voltage (see table below),
- scaling_factor Correction factor for Isc (set to 1.00).

U_n	Input voltage range (L-PE)
110 V	$(93 \text{ V} \leq U_{L-PE} \leq 134 \text{ V})$
230 V	$(185 \text{ V} \leq U_{L-PE} \leq 266 \text{ V})$

Modifications of the chapter 5.6

Modified test parameters for line impedance measurement

Fuse type	Selection of fuse type [---, FUSE, B, C, D]
Lim	High limit line impedance value for selected fuse.

See Appendix A.2 for reference fuse data.

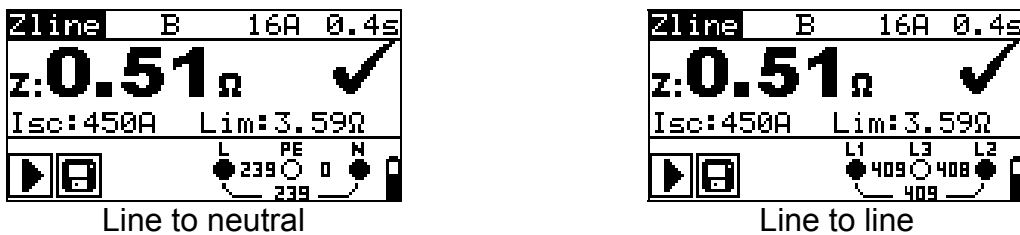

Figure C.4: Examples of line impedance measurement result

Displayed results:

- Z** line impedance
- Isc**prospective short-circuit current
- Lim**high limit line impedance value.

Prospective short circuit current I_{PFC} is calculated from measured impedance as follows:

$$I_{PFC} = \frac{U_N}{Z_{L-N(L)} \cdot \text{scaling_factor}}$$

where:

- U_n Nominal U_{L-N} or U_{L1-L2} voltage (see table below),
- Scaling factor Correction factor for Isc (set to 1.00).

U_n	Input voltage range (L-N or L1-L2)
110 V	$(93 \text{ V} \leq U_{L-N} < 134 \text{ V})$
230 V	$(185 \text{ V} \leq U_{L-N} \leq 266 \text{ V})$
400 V	$(321 \text{ V} < U_{L-L} \leq 485 \text{ V})$

Appendix D – Commanders (A 1314, A 1401)

D.1 Warnings related to safety

Measuring category of commanders:

Plug commander A 1314 300 V CAT II

Tip commander A1401

(cap off, 18 mm tip) 1000 V CAT II / 600 V CAT II / 300 V CAT II

(cap on, 4 mm tip)...1000 V CAT II / 600 V CAT III / 300 V CAT IV

- ❑ Measuring category of commanders can be lower than protection category of the instrument.
- ❑ If dangerous voltage is detected on the tested PE terminal, immediately stop all measurements, find and remove the fault!
- ❑ When replacing battery cells or before opening the battery compartment cover, disconnect the measuring accessory from the instrument and installation.
- ❑ Service, repairs or adjustment of instruments and accessories is only allowed to be carried out by a competent authorized personnel!

D.2 Battery

The commander uses two AAA size alkaline or rechargeable Ni-MH battery cells. Nominal operating time is at least 40 h and is declared for cells with nominal capacity of 850 mAh.

Notes:

- ❑ If the commander is not used for a long period of time, remove all batteries from the battery compartment.
- ❑ Alkaline or rechargeable Ni-MH batteries (size AA) can be used. Metrel recommends only using rechargeable batteries with a capacity of 800 mAh or above.
- ❑ Ensure that the battery cells are inserted correctly otherwise the commander will not operate and the batteries could be discharged.

D.3 Description of commanders

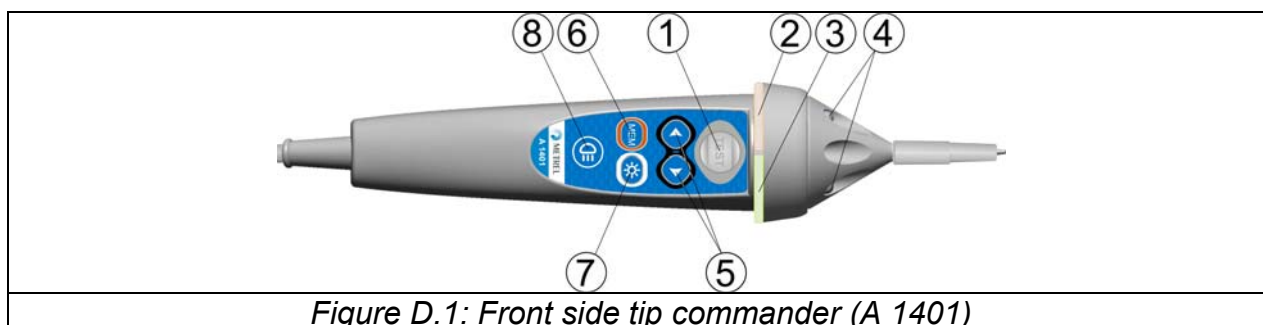

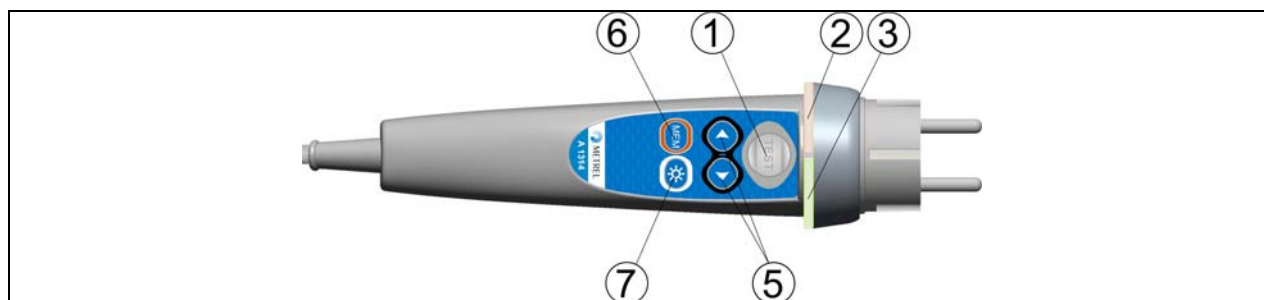

Figure D.2: Front side plug commander (A 1314)

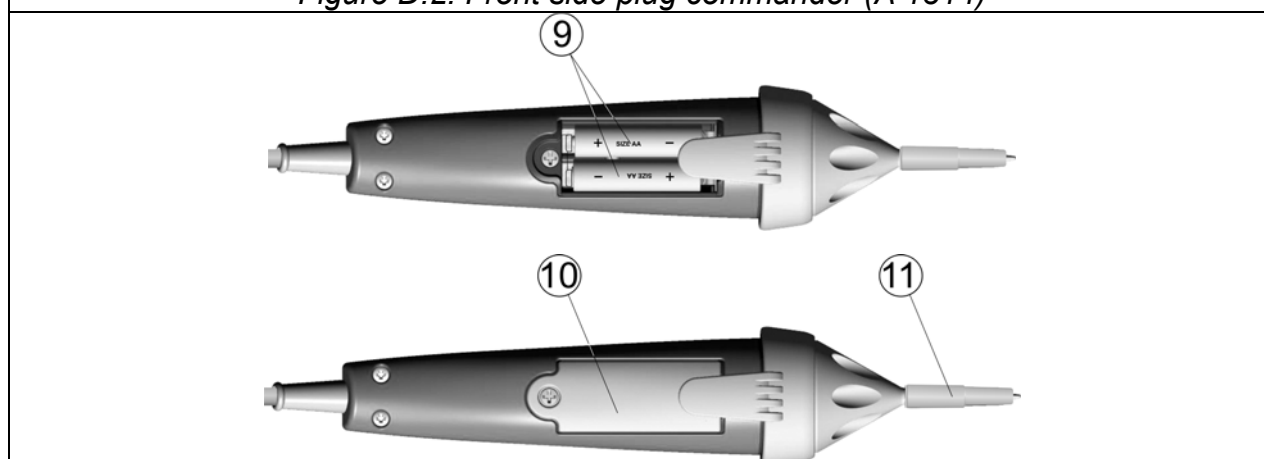

Figure D.3: Back side

Legend:

1	TEST	TEST	Starts measurements. Acts also as the PE touching electrode.
2	LED	Left status	RGB LED
3	LED	Right status	RGB LED
4	LEDs	Lamp LEDs (Tip commander)	
5	Function selector	Selects test function.	
6	MEM	Store / recall / clear tests in memory of instrument.	
7	BL	Switches On / Off backlight on instrument	
8	Lamp key	Switches On / Off lamp (Tip commander)	
9	Battery cells	Size AAA, alkaline / rechargeable NiMH	
10	Battery cover	Battery compartment cover	
11	Cap	Removable CAT IV cap (Tip commander)	

D.4 Operation of commanders

Both LED yellow	Warning! Dangerous voltage on the commander's PE terminal!
Right LED red	Fail indication
Right LED green	Pass indication
Left LED blinks blue	Commander is monitoring the input voltage

Left LED orange	Voltage between any test terminals is higher than 50 V
Both LEDs blink red	Low battery
Both LEDs red and switch off	Battery voltage too low for operation of commander

PE terminal test procedure

- ❑ **Connect** commander to the instrument.
- ❑ **Connect** commander to the item to be tested (see *figure D.4*).
- ❑ Touch PE test probe (the **TEST** key) on commander for at least one second.
- ❑ If PE terminal is connected to phase voltage both LEDs will light yellow, the warning message on the instrument is displayed, instrument's buzzer is activated, and further measurements are disabled in Zloop and RCD functions.

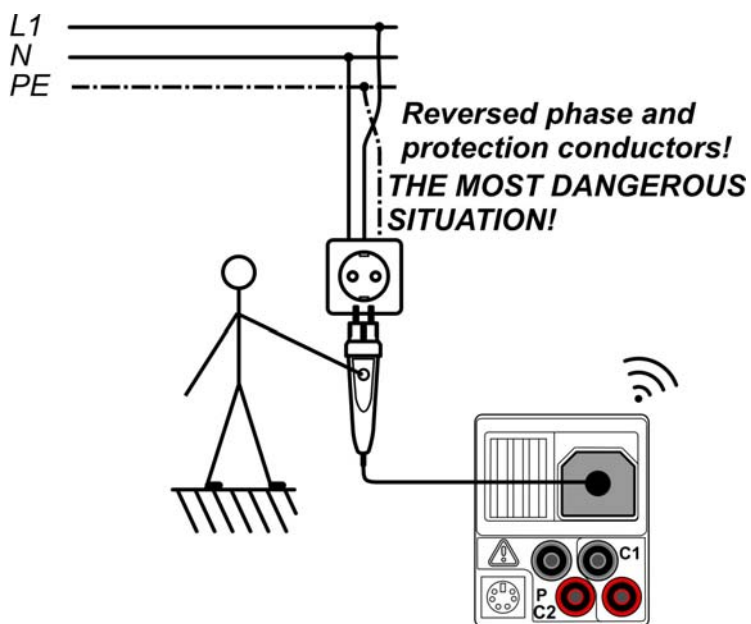

Figure D.4: Reversed L and PE conductors (application of plug commander)

Appendix E – PV measurements - calculated values

Calculation with known U, I (DC, AC), configuration of modules into a string (M - modules in serial, N - modules in parallel), environment parameters (Irr, T) and data supplied by the panels manufacturer (U, I (AC, DC), phase, I_{stc}, γ, P_{nom}, NOCT, Irr, Irr_{stc}, Tamb or T_{cell})

Panel (DC):

$$P_{DC} = \sum_{i=1}^3 U_{meas,i} I_{meas,i} ,$$

U and I are measured on panel connectors, i is for multi-phase systems (i = 1 ÷ 3).

Inverter (AC):

$$P_{AC} = \sum_{i=1}^3 U_{meas,i} I_{meas,i} \cos \varphi_i$$

U, I and phase are measured on inverter connectors, i is for multi-phase systems (i = 1 ÷ 3).

Conversion efficiency:

1. panel:

$$\eta_2 = \frac{P_{DC}}{P_{theo}} , \quad P_{theo} = M \cdot N \cdot P_{nom} \frac{Irr}{Irr_{STC}} ,$$

where P_{nom} is nominal power of panel at STC, Irr_{STC} is nominal irradiance at STC ($Irr_{STC} = 1000 \text{ W/m}^2$), Irr is measured irradiance, M is number of modules in serial and N is number of modules in parallel.

η_2	Efficiency of panel
P_{theo}	Theoretical power of string at measured irradiance
P_{nom}	nominal power of panel at STC
Irr_{stc}	nominal irradiance at STC ($Irr_{stc} = 1000 \text{ W/m}^2$)
Irr	measured irradiance
M	number of modules in serial
N	number of modules in parallel

Depending on temperature criterion for PASS is:

- If $T_{amb} < 25 \text{ °C}$ or $T_{cell} < 40 \text{ °C}$ $\Rightarrow \eta_2 > 0.85$
- If $T_{amb} > 25 \text{ °C}$ or $T_{cell} > 40 \text{ °C}$ $\Rightarrow \eta_2 > (1 - \eta_{PV} - 0.08)$,

where η_{PV} is calculated depending on type of temperature being measured as

$$\eta_{PV} = \left[T_{amb} - 25 + (NOCT - 20) \frac{Irr}{0,08} \right] \cdot \gamma$$

or

$$\eta_{PV} = (T_{cell} - 25) \cdot \gamma$$

where NOCT is nominal operating temperature of the cell (data supplied by the panels manufacturer) and γ is coeff. of temperature of power characteristic of PV module (inserted value from 0,01 to 0,99) (data supplied by the panels manufacturer).

NOCT	nominal operating temperature of the cell (data supplied by the panels manufacturer)
γ	coeff. of temperature of power characteristic of PV module (inserted value from 0,01 to 0,99) (data supplied by the panels manufacturer)

2. inverter:

$$\eta = \frac{P_{AC}}{P_{DC}}$$

Calculation of conversion efficiency with comparison of STC and measured-corrected values

(U, I (AC, DC), phase, Irr_{stc}, Tstc, Pnom, Irr, Tcell, Rs, α , β , Isc, M, N)

Panel:

Measured U and I are corrected to STC conditions:

$$I_{STC} = I_1 + I_{SC} \cdot \left(\frac{Irr_{STC}}{Irr} - 1 \right) + N \cdot \alpha \cdot (T_{STC} - T_1)$$

$$U_{STC} = U_1 - \frac{M}{N} \cdot R_s \cdot (I_{STC} - I_1) + M \cdot \beta \cdot (T_{STC} - T_1)$$

where I_1 and U_1 are measured direct current and voltage at panel, I_{sc} is measured short-circuit current of panel, Irr_{STC} is irradiance at STC, Irr is measured irradiance, α and β are the current and voltage temperature coeff. off panel, T_{STC} is temperature at STC, T_1

is measured temperature, R_s is serial resistance of panel, M is number of modules in serial and N is number of modules in parallel.

I_{stc}, U_{stc}	Calculated values of current and voltage at standard test condition
I_1, U_1	measured direct current and voltage at panel
I_{sc}	measured short-circuit current of panel
Irr_{stc}	irradiance at STC
Irr	measured irradiance
α, β	current and voltage temperature coeff. of panel
T_{stc}	temperature at STC
T_1	measured temperature
	serial resistance of panel
M	number of modules in serial
N	number of modules in parallel

$$P_{STC} = I_{STC} \cdot U_{STC}$$

Conversion efficiency:

1. panel:

$$\eta_1 = \frac{P_{STC}}{M \cdot N \cdot P_{nom}}$$

2. inverter:

$$\eta = \frac{P_{AC}}{P_{DC}}$$