



Precision Rated Optics

Work with a PRO!

OFS-947S

Core-Alignment Fusion Splicer



Operation Guide

1. Technical Specifications

Applicable fiber type	SM(ITU-T G.652&G.657) / MM(ITU-T G.651) / DS(ITU-T G.653) / NZDS(ITU-T G.655)
Fiber count	Single
Applicable fiber cables	0.25mm- 3.0mm/ Indoor Cable
Applicable fiber diameter	Cladding diameter: 80-150 μ m / Coating diameter: 125-1000 μ m
Splice loss	SM : 0.02dB, MM : 0.01dB, DS : 0.04dB, NZDS : 0.04dB, G.657 : 0.02dB
Splice mode	128 splice modes
Internal splice data storage	2000
Splicing time	SM Quick mode: 7s
Heat oven	20mm, 30mm, 40mm, 50mm, 60mm
Heating time	8- 900s
Typical heating time	13s
Heat mode	Various heat modes available
Displaying method	Two cameras and 5.0 inch color LCD monitor
Magnification	520x for single X or Y view, or 520x for both X and Y view
Tensile test	1.96-2.25N
Terminals	USB2.0 / MINI USB
Standard AC power voltage	AC 100-240V, 50-60Hz
Standard DC power voltage	DC 9-14V
Size (HxWxD)	167mm x 143mm x 163mm
Weight	2.80kg (battery included)
Operating condition	0~5000m above sea level, 0~95% relative humidity, -10~50°C, 15m/s max wind speed
Storage condition	0~95% relative humidity, -40~80°C
Battery	-20~30°C for long time storage

Battery precautions

DO NOT collide the battery with sharp or hard objects.

DO NOT transport or store the battery with metals simultaneously.

DO NOT throw, drop, impact or bend the battery.

DO NOT strike the battery with hammers or tread on it.

DO NOT connect the anode and cathode of the battery to metals such as electrical short circuit.

DO NOT let the anode and cathode contact with the external aluminum coating of the battery so as to avoid short circuit.

DO NOT disassemble the battery under any circumstances.

DO NOT immerse the battery in fresh water or sea water, and avoid moisture.

DO NOT use or place the battery near heat source. (e.g. fire, heat oven)

DO NOT heat the battery or throw it into water.

DO NOT weld the battery directly.

DO NOT charge the battery near fire or in high temperature.

DO NOT put the battery into the microwave oven or high pressure container.

DO NOT use or place the battery in extremely high temperature (e.g. strong sunlight or inside a car which is with poor ventilation) for long period of time. Otherwise, it may cause overheat, fire, battery malfunction, or shorter battery life.

DO NOT use damaged battery. The battery with electrolyte leakage or electrolyte smell shall be kept away from fire to avoid fire or explosion.

If electrolyte leakage contacts with skin or other parts of body, please wash it off with a plenty of water immediately. If electrolyte leakage contacts with your eye(s), please rinse your eye(s) with water immediately and seek medical advice.

2. Installation

Safety warnings and precautions

As OFS-947S is designed for fusion splicing silica glass optical fibers, it is very important that the splicer should not be used for any other purposes. The splicer is a precision instrument and must be handled with caution. Therefore, you must read the following safety rules and general precautions in this manual regarding the use and handling of OFS-947S at any time. Any behaviors that do not follow the warnings and cautions will break the safety standard about design, manufacture, and usage of the fusion splicer. PRO will not take the responsibility for those consequences caused by misuse!

Operational safety warnings

Never operate the splicer in an environment where flammable liquids or vapors exist.

DO NOT touch the electrodes when the splicer is on.

Note: Only use specified electrodes for the fusion splicer. Select [Replace electrode] in maintenance menu to replace electrodes, or turn off the splicer and disconnect the AC power source or remove battery before replacing electrodes. Discharging is prohibited before the electrodes are placed as a pair.

DO NOT disassemble or modify any components of the splicer without approval, except for the permitted-to-disassemble / modify components or parts by users stated in this manual. Component replacement and its internal adjustment must be implemented by PRO or its authorized technicians or engineers.

Never operate the splicer in an environment where flammable liquids or vapors exist. Risk of dangerous fire or explosion could result from the splicer's electrical arc in such an environment. DO NOT operate the splicer near hot objects or in high temperature and dusty / humid atmosphere, or when condensation is present on the splicer. This may result in electric shock, splicer malfunction, or poor splicing performance.

Users should always wear safety glasses during fiber preparation and splicing operation. Fiber fragments can be extremely dangerous if they are ingested or come into contact with eyes, skin.

Take out the battery immediately if the followings are observed when using the splicer:

- Fumes, bad smell, abnormal noise or over heat.
- Liquid or other matter falls into cabinet
- The splicer is damaged or dropped.

Note: If any of these faults occurs, please contact our service center immediately. Leaving the splicer in a damaged state without any prompt measures may cause equipment failure, electric shock, or fire and may result in injury or death.

Do not use compressed gas or canned air to clean the splicer. They may contain flammable materials that could ignite during the electrical discharge.

Please use OFS-947S designed battery only. Using an improper AC power source may cause fuming, electric shock or equipment damage and may even result in fire, injury or death.

Please use OFS-947S designed charger only. Do not place any heavy objects on the AC power cord. Keep the power cord away from heat source. Using an improper cord or a damaged cord may cause fuming, electric shock or equipment damage and may even result in fire, injury or death.

Maintenance and external care precautions

Always avoid using hard objects to clean V-grooves and electrodes.

Always avoid using acetone, thinner, benzol or alcohol when cleaning any parts of the splicer, except for the places advised.

Use a dry cloth to remove dust and dirt from the splicer.

If the outside of the splicer is dirty, plunge a soft cloth into diluted neutral washing up liquid, wring out the cloth and clean. Dry the splicer with a dry cloth but **DO NOT USE** furniture polish or other cleaning agents.

Always follow the maintenance instructions in this manual.

Transport and storage precautions

When the splicer is moved from cold to warm environment, you should allow the splicer to warm up gradually. Otherwise, the condensation generated inside will bring harmful effects to the splicer.

Pack the fusion splicer well for long time storage.

Keep the splicer clean and dry.

The splicer is precision adjusted and aligned. Always keep the splicer in its carrying case to protect from damage and dirt. Put cushion package outside the carrying case for long distance transportation.

Always avoid leaving the splicer in direct sunlight or expose to excessive heat.

Do not store the splicer in dusty or humid environment. This may result in electric shock, splicer malfunction or poor splicing performance.

Keep the humidity to a minimum level where the splicer is stored. The humidity must not exceed 95%.

Unpacking the splicer

Hold the handle upwards, then lift the splicer out of the carrying case.

Package

Splicer, High Precision Cleaver, Replaceable Fiber Holders, SOC Heater Cover, AC Adapter, Cooling Tray, Electrode, Electrode Grinder, Manual CD, Battery Pack, Power Cable, USB Cable, Cigarette Lighter Cable, Carrying Case, User manual, Supplier's declaration of conformity, Test protocol

Equipped with fiber holder

Splicer overview

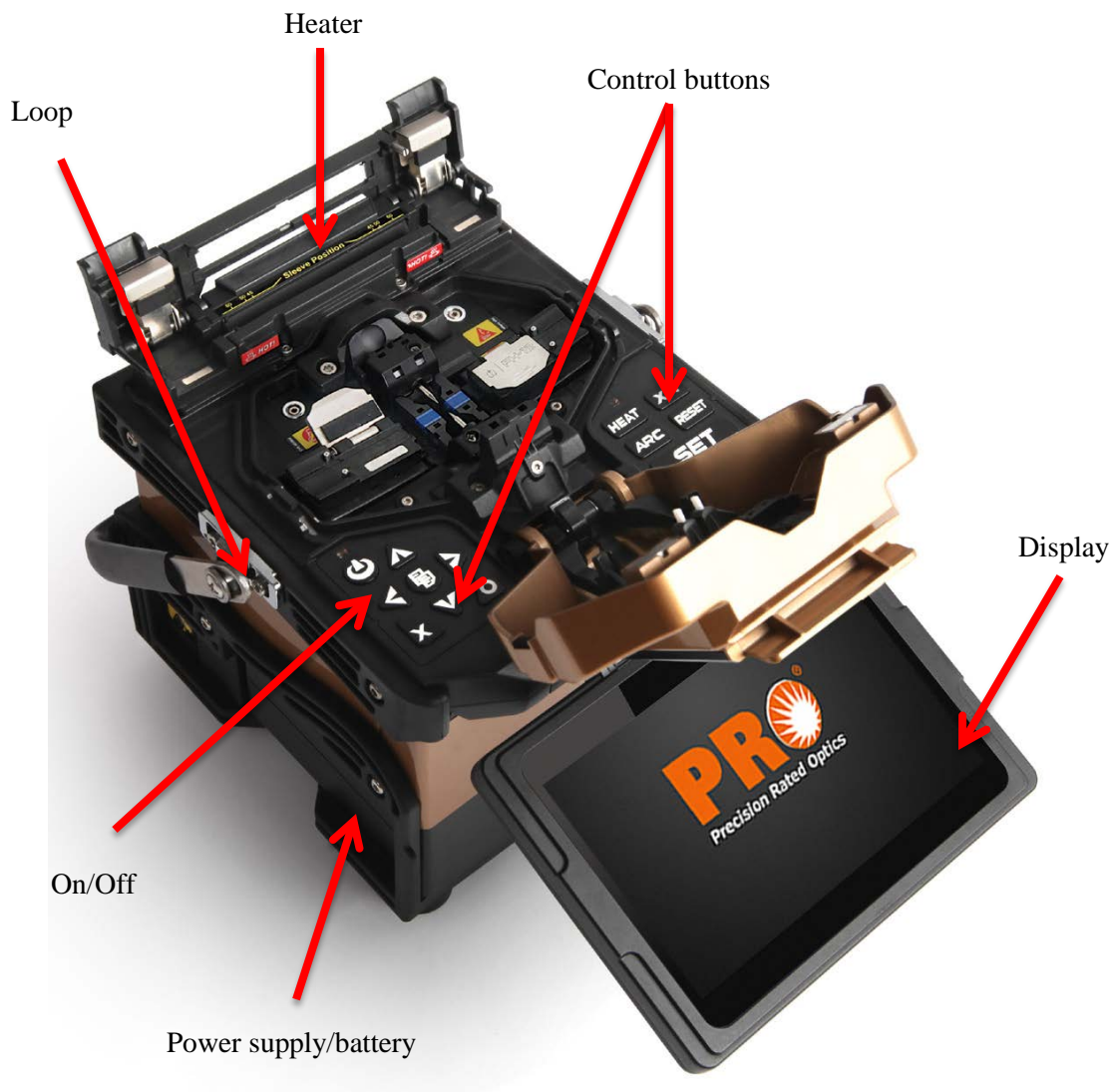

Power supply

Battery

Switch off the splicer. Press the [Release] button at the side of the splicer and take out the battery from the splicer.

Charge the battery

Connect the battery charger to the battery.

Charging progress is indicated by five lit LEDs continuously sweeping from 20% to 100% on the battery indicator (see below). As charging proceeds, one LED is lit when 20% charged. When it's fully charged, all five LEDs are lit (i.e. 100%).

Note: Check and make sure the remaining battery capacity is 20% or greater before splicing. If the battery capacity is less than 20%, please use AC / DC adapter to power the splicer. Heat will be generated during the charging process. Do not stack the battery on top of AC / DC adapter while charging.

How to check remaining battery capacity

You have two ways to check remaining battery capacity.

- If the battery is connected to the splicer, its charging level appears on the top right corner of the monitor.
- If the battery is detached from the splicer, press “PUSH” button on the battery. Then the battery capacity will be indicated by LEDs as shown below:



Battery refresh

In order to prevent the aging effect of the battery, the battery needs to be refreshed periodically. Turn the splicer on and discharging until it consumes all the battery capacity and the splicer turns off automatically. Fully recharge the battery and redo discharging.

3. Basic Operation

Turning on the splicer

Press [Power] key on the operation panel, and wait the splicer to be turned on and move to Workbench page.



Adjusting the monitor position

Users can adjust the monitor position by moving it with a desired angle in purpose of operation convenience.

Adjusting the monitor brightness

In the initial interface, press “◀” or “▶” to adjust the monitor brightness until a clear image can be seen.



Note: The LCD monitor is a precise component produced by manufacturing factory under strict quality control. However, some tiny dots in different colors may still remain on the screen. Meanwhile, the screen brightness may not appear uniform, depending on its viewing angles. Note that these symptoms are not defects, but are natural phenomenon.

Touch screen On/Off

Users can choose their operation styles based on their operating patterns.

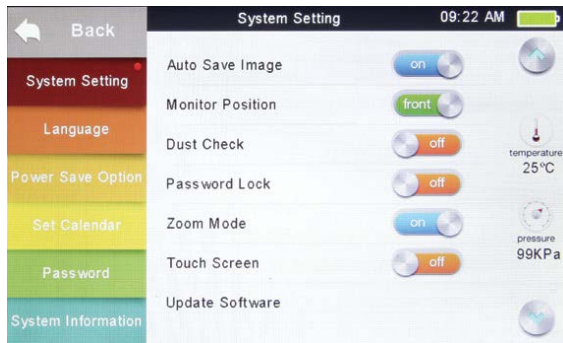

When the touch screen switch is [Off], users can only perform operation by pressing buttons.

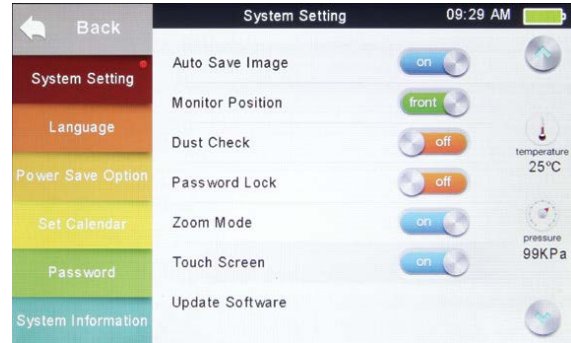

When the touch screen switch is [On], users can perform operation by both pressing

Fiber zoom function on screen

Users can zoom in the fiber image by double tapping on the screen so as to observe the splicing result and check the splicing condition.

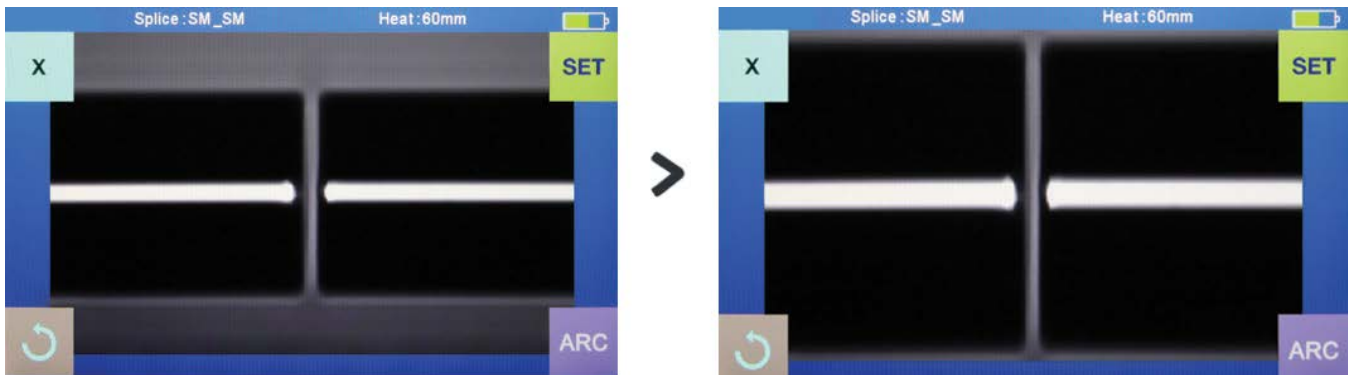

Preparing the fibers

3 Steps should be carried out before splicing:

Step 1: Strip the fiber

Remove at least 50mm of secondary coating (valid for both tight and loose tube secondary coating) and approximately 30~40mm of primary coating with an appropriate stripper

.Step 2: Clean the fiber

Clean bare fibers with pure alcohol-soaked gauze or lint-free tissue.

Step 3: Cleave the fiber

In order to ensure the best splicing result, cleave the fibers with high precision cleaver, and strictly control the cleaving lengths shown as below.

Note: Remember to slip a heat-shrink sleeve onto either end of the fibers at the beginning of each fiber preparation.

Examples of cleaving lengths

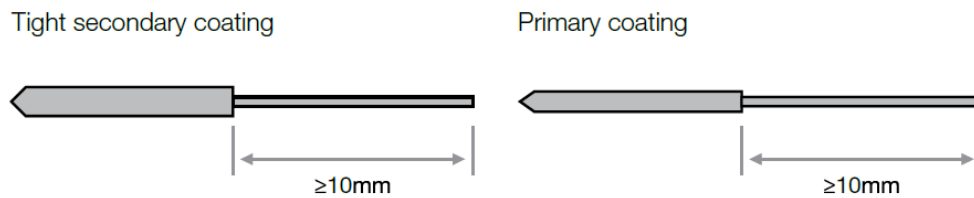

Use blue V-grooves (clamping on bare fiber)

Important: Make sure that the bare fiber and its cleaved section are clean.

- Avoid putting the fibers on a dusty working surface.
- Avoid swaying the fibers in the air.
- Check if the V-grooves are clean. If not, must clean it with pure alcohol-soaked cotton swabs.
- Check if the fiber holders are clean. If not, must clean it with pure alcohol-soaked cotton swabs.

How to make a splice

Placing the fibers

- 1) Open the windproof cover.
- 2) Raise the fiber holders.
- 3) Place the fiber into V-grooves and make sure that the fiber ends are placed between the edge of V-grooves and the electrode ends.

Note: Make sure to avoid sliding the fibers along V-grooves, but rather position them over V-grooves and tilt them down into place (as shown below).

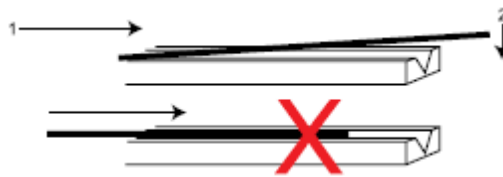

- 4) Clamp the fiber in position by lowering both sets of fiber holders.
- 5) Close the windproof cover.

Inspecting the fibers

Before continuing with splicing, inspect the fibers whether they are clean and well-cleaved. If any defects are found, please remove the fibers and prepare again.

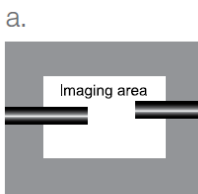

Fiber ends visible on the monitor.

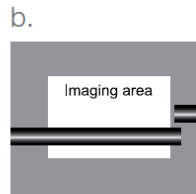

Fiber ends outside monitor.

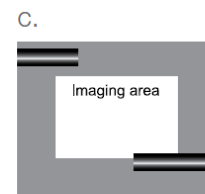

Fiber ends above and below monitor, not possible to find automatically.



Note: The fibers are checked automatically when you press “Set” button. The splicer automatically focuses the fibers and checks for damage or dust particles.

Splicing

- Select any appropriate splice mode.
- Start splicing by pressing [SET] button.

Note: If the splicer is set as “Auto mode”, splicing will start automatically once the windproof cover is closed.

How to protect the splice

After splicing, put the fiber with heat-shrink sleeve into the heat oven. Press [HEAT] button to execute heat-shrink process to strengthen the splice point.

Heating procedure

- 1) Open the heat oven lid.
- 2) Lift the left and right fiber holders on the splicer. Hold the heat-shrink sleeve (previously placed onto the fiber). Lift the spliced fibers and hold them taut. Then move the heat-shrink sleeve to the splice point.
- 3) Place the fiber with heat-shrink sleeve in the heat oven clamp.
- 4) Press [HEAT] button to start heating. Upon completion, the heating LED indicator will go off with buzzing.

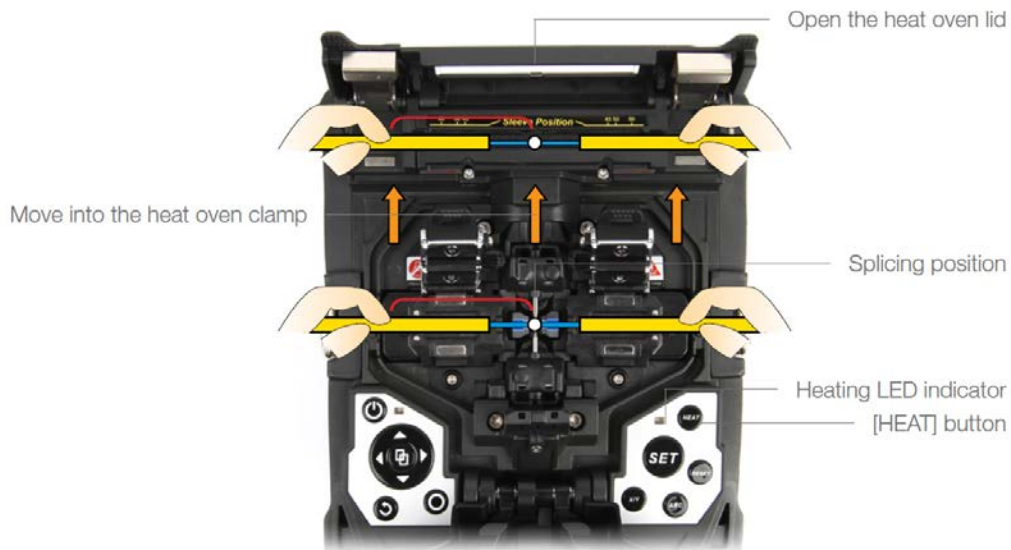

4. Splice Programs

OFS-947S has an intuitive and simple but very powerful program structure to operate. Splice programs define arc currents, splice times as well as various parameters used when performing a splice. Therefore, it is essential to select the correct splice program. There are a number of “preset” splice programs for common fiber combinations. Therefore, it is much easier to modify and further optimize the parameters for more unusual fiber combinations.

Displaying the active splice program

The active splice program is always displayed at the top of the screen (see below).

Displaying the active splice program

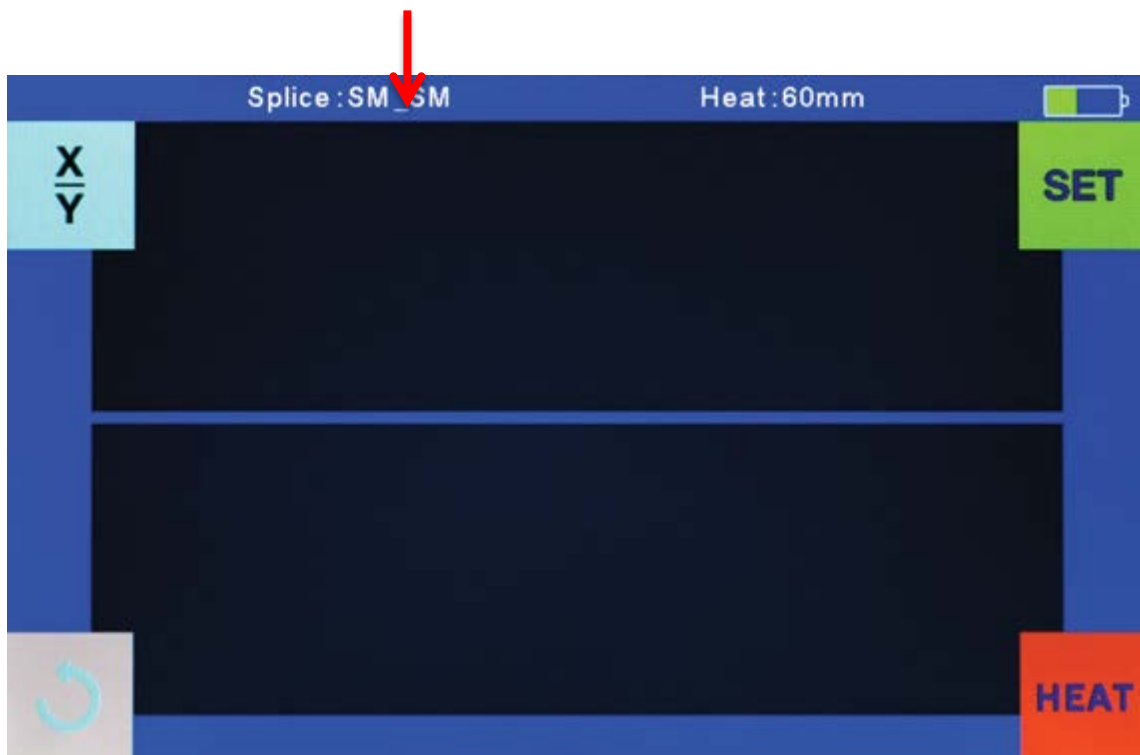

Selecting a splice program

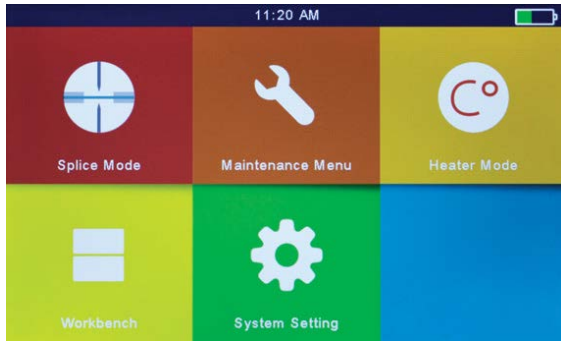

Select [Splice mode] from the main menu.

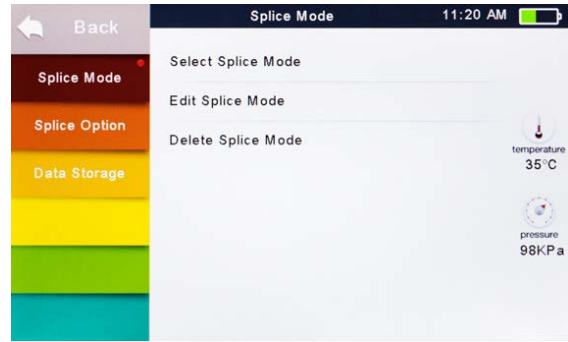

Select [Splice mode] and select [Select splice mode].



Select an appropriate splice mode

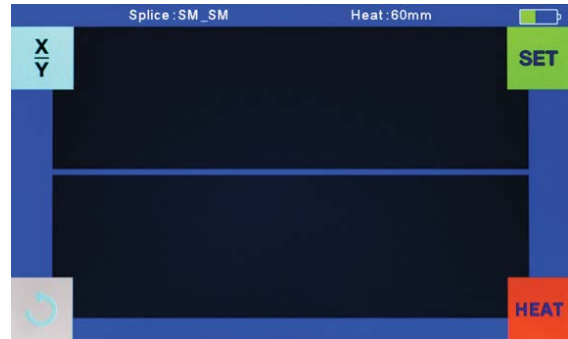

Selected splice mode appears on the screen. Press [RESET] button to return to initial interface page.

General splicing steps

This section explains the steps involved in automatic splicing process and describes how various program parameters are related to this process. The normal splicing process can be divided into two sections; pre-fusion and fusion.

Pre-fusion

During pre-fusion, the splicer performs automatic alignment and focusing, where the fibers are subjected to a low pre-fuse current for cleaning purposes; a pre-fuse image is also taken. At this point, the user is informed of any problems recognized in the pre-fuse image, such as a poorly prepared fiber. The splicer will then issue a warning before the fibers are fused together.

Fusion

During fusion, the fibers are joined together and subjected to five different currents as illustrated below. An important parameter, which changes during splicing, is the distance between the fibers. During pre-fusion, the fibers are apart. With the current phase changing, fibers are spliced gradually.

Splicing process

Arc power and arc time are considered as the two most important parameters (as shown in the figure below). The name and purpose of those parameters as well as the effect and importance of the parameters will be described in the next section “Splice program parameters under general splicing process”. The below figure shows the arc discharge conditions (relationship between “Arc power” and “Motor motion”). These conditions can be modified by changing the splicing parameters listed below. However, depending on the splice mode, certain parameters cannot be changed.

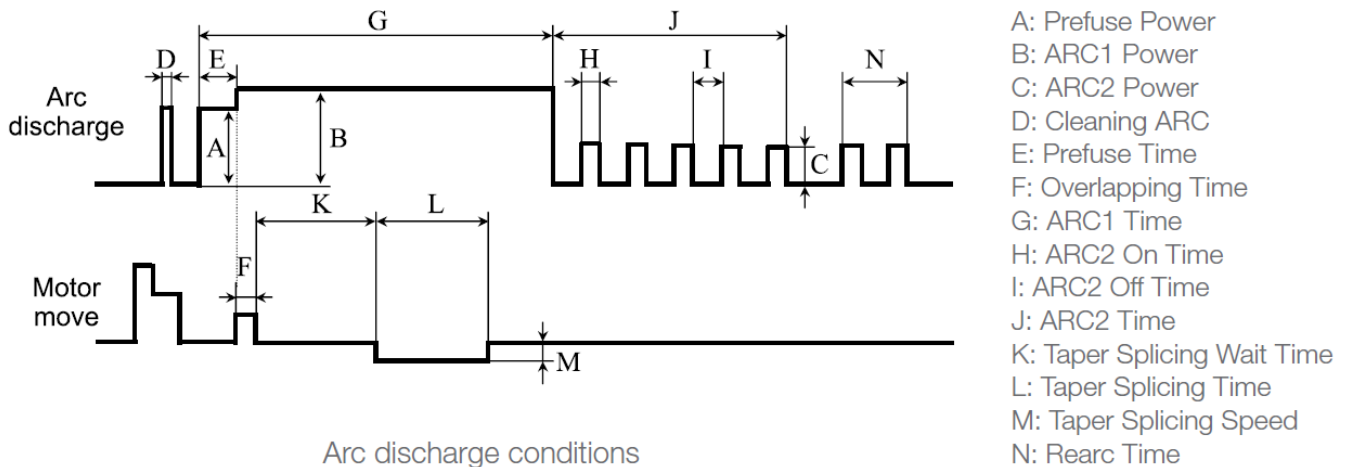

Splice program parameters under general splicing process

Parameter	Description
Template	A list of splice modes stored in the splicer database. Upon inputting the appropriate mode, the selected splice mode stored in database area is copied to a user-programmable area.
Name	Title for a splice mode expressed in up to seven characters.
Note	Detailed explanation for a splice mode expressed in up to 15 characters. It is displayed at [Select splice mode] menu.
Arc Adjust	Set to adjust arc power according to the fibers' conditions.
Pull Test	If [Pull test] is set to "On", a pull-test is performed upon opening the windproof cover or by pressing [SET] button after splicing.
Loss Estimate	Loss estimate should be regarded as a reference. Since the loss is calculated upon the fiber image, there is certain difference with the real value. The estimate method is based on a single mode fiber and calculates at the wavelength of 1.31 μ m. The estimated value can be a valuable reference, but cannot be used as the basis of acceptance.
Min Loss	This amount is added to the estimated splice loss originally calculated. When splicing specialty or dissimilar fibers, a high actual splice loss may occur even with optimized arc conditions. To make the actual splice loss concur with the estimated splice loss, set the actual splice loss to minimum value (minimum loss).
Loss Limit	An error message is displayed if the estimated splice loss exceeds the selected threshold (loss limit).
Core Angle Limit	An error message is displayed if the bend angle of the two fibers spliced exceeds the selected threshold (core angle limit).
Cleave Angle Limit	An error message is displayed if the cleave angle of either the left or right fiber ends exceeds the selected threshold (cleave angle limit).
Gap Position	Set the relative position of the splicing location to the center of electrodes. Splice loss may be improved in the case of dissimilar fiber splicing by shifting [Gap position] towards a fiber whose MFD is bigger than the other fiber MFD.
Gap	Set the end-face gap between the left and right fibers at the time of aligning and pre-fusion discharge.
Overlap	Set the overlap amount of fibers at the fiber propelling stage. Relatively small [Overlap] is recommended if [Preheat Arc Value] is low, while relatively large [Overlap] is recommended if [Preheat Arc Value] is high.
Clean Arc Time	A cleaning arc burns out micro dust on the surface of the fiber with an arc discharge for a short period of time. The duration of the cleaning arc can be changed by this parameter.
Preheat Arc Value	Set the preheat arc power from the beginning of arc discharging to the beginning of fibers propelling. If [Preheat Arc Value] is set too low, axial offset may occur if cleaved angles are relatively poor. If [Preheat Arc Value] is set too high, fiber end-faces are fused excessively and splice loss gets worse.
Preheat Arc Time	Set the preheat arc time from the beginning of arc discharging to the beginning of fibers propelling. Long [Preheat Arc Time] and high [Preheat Arc Value] lead to the same results.
Fuse Arc Value	Set arc power
Fuse Arc Time	Sets arc time

5. Splice Option

Setting up splice mode



- 1) Select [Splice option] in menu.
- 2) Select a parameter to be changed

Parameter	Description
Auto Start	If "Auto Start" is set to "On", splicing starts automatically as soon as the windproof cover is closed. Fibers should be prepared and placed into the splicer in advance.
Pause 1	If "Pause1" is set to "On", splicing operation pauses when fibers are forwarded to gap-set position. Cleave angles are displayed during the pause.
Pause 2	If "Pause2" is set to "On", splicing operation pauses after fiber alignment is completed.
Realign After Pause2	Alignment failure may appear after "Pause2" for a long period. Therefore, realign after "Pause2" is needed. Setting to "OFF" will prevent the implementation of realign function. Manual splicing, rather than setting the realign to "OFF", is recommended when there is an axial displacement of the splicer.
Ignore Splicing Error	
Cleave Angle	Setting to "OFF" ignores the faults and continues to complete the splicing even if the message "Cleave Angle Error" appears.
Core Angle	Setting to "OFF" ignores the faults and continues to complete the splicing even if the message "Core Angle Error" appears.
Loss, Fat, Thin	Setting to "OFF" ignores the faults and continues to complete the splicing even if the message "Loss Error", "Cleave Shape Error", "Fat Error", or "Thin Error" appears.
Fiber Image On Screen	
Gap Set, Pause1, Align, Pause2, Arc, Estimate	Set the displaying method of the fiber image on the screen during splicing operation.

6. Heater Mode

The splicer provides max 32 heat modes including various heat modes preset by PRO and the rest that can be defined by users. Select a heating mode that best matches with the protection sleeve used. For each type of protection sleeve, OFS-947S has its optimum heating mode. These modes can be found in the database area for reference. Copy the appropriate mode and paste it to the user-programmable area. Users can edit those parameters.

Selecting heater mode

Select [Select Heat Mode] in [Heater Mode] menu.

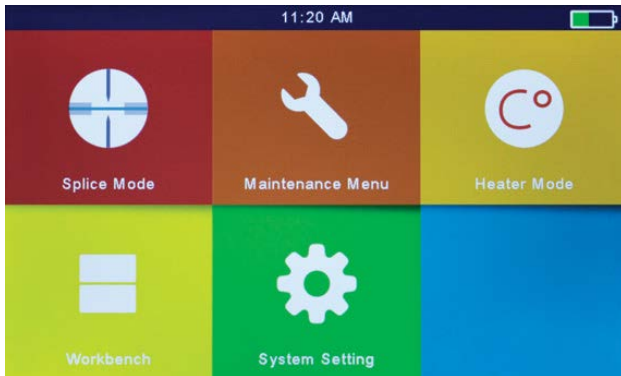

Select [Heater Mode] menu

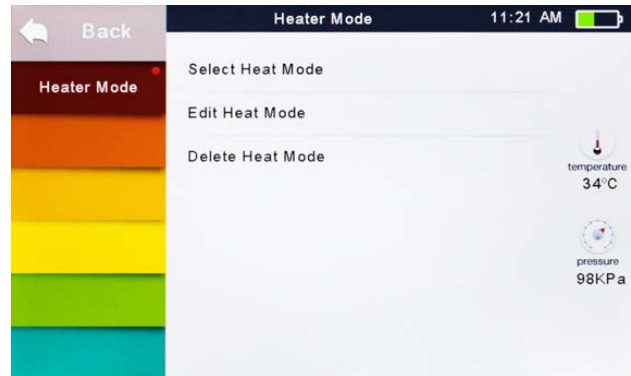

Select [Select Heat Mode].



Select heat mode

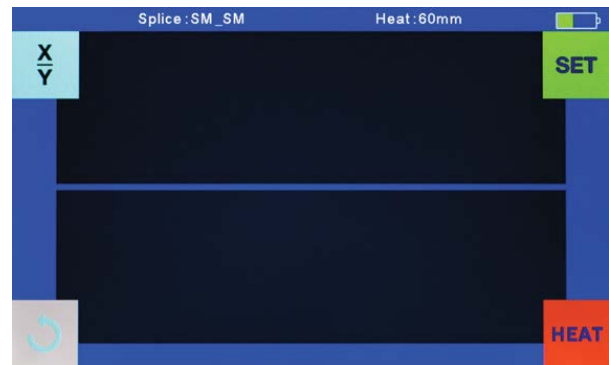

Selected heat mode appears on the screen. Press [RESET] button to return to initial interface.

Editing heat mode

Heating conditions stored in heater mode can be edited or changed.

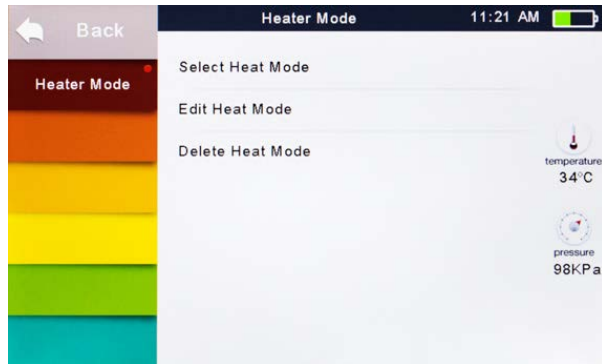

Select [Edit Heat Mode] in [Heater mode] menu.



Select the mode to be edited

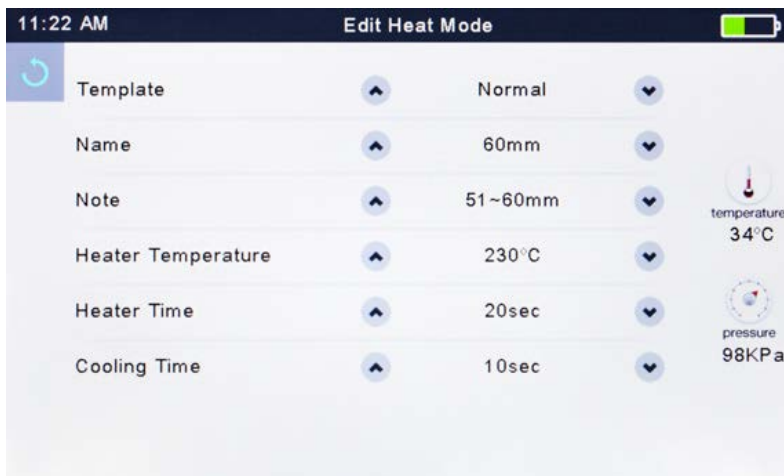

Select the parameters to be edited.

Deleting heat mode

- 1) Select [Heater Mode] menu.
- 2) Select [Delete Heat Mode].
- 3) Select the heat mode to be deleted.

Note: The gray modes (20mm, 30mm) are the system preset initial heat modes which cannot be deleted.

Heat mode parameters

Parameter	Description
Template	Set sleeve type. List of all heat modes are displayed. Selected mode will be copied to a user-programmable area.
Name	Title for a heat mode.
Note	Title of the heat mode displayed in the upper right corner of the monitor during splicing or heating process. Max number of character used is 5
Heater Control	Set the length of heat-shrink sleeve. Long: protection sleeves over 30mm. Short: 30mm protection sleeves or below
Heat Temperature	Set heating temperature
Heater Time	Set heating time from the beginning to the heating completed

7. Maintenance Menu

The splicer has a function to perform routine maintenance. This chapter describes how to use the maintenance menu.

- 1) Press \square button, and select [Maintenance menu].
- 2) Select a function to perform.

Replace electrodes

As electrodes are worn out during the splicing process, oxide generated on the tips of electrodes should be regularly eliminated. It is recommended that the electrodes should be replaced after 1500 arc discharges. When the number of arc discharges reaches a count of 1500, a message prompting to replace the electrodes is displayed immediately after turning on the power. Using the electrodes without a replacement will result in greater splice loss and reduced splice strength.

Replacement procedure

- 1) Select [Replace electrodes] in [Maintenance Menu].
- 2) Instruction messages will appear on the screen to turn off the power. Then turn off the splicer.
- 3) Remove the old electrodes.
 - a. Loosen screw located on electrode cover.
 - b. Take electrodes out of the electrode covers. (electrodes are fixed in electrode cover)
- 4) Clean the new electrodes with alcohol-impregnated clean gauze or lint-free tissue, and install them in the splicer.
 - a. Insert the electrodes in the electrode covers.
 - b. Place the electrode covers on the splicer, and tighten the screws.

Note: Do not pull out wiring when replacing electrode. Do not exceed the normal finger strength when tightening screw.

PRO strongly recommends all users to do stabilizing electrodes and arc calibration after electrodes replacing to keep good splice results and splice strength (Details are described below).

Stabilize electrodes

In the event of sudden change in environmental conditions, especially when the splicer is moved from lower altitudes to higher altitudes, the arc power may become unstable, resulting in higher splice loss. In such case, it takes time for arc power to be stabilized. In this case, stabilizing electrodes will expedite the process to set the arc power stable. If many tests are needed until the “Operation Complete” message appears in [Arc calibration], use this function as well.

Operation procedure

- 1) Select [Stabilize electrodes].
- 2) Place prepared fibers into the splicer for splicing.
- 3) Press [SET] button, and the splicer will begin to stabilize the electrodes automatically in the following procedures:
 - a. Repeat arc discharge five times to measure the arc position.
 - b. Perform splicing rapidly.
 - c. Perform stabilizing electrodes 20 times consecutively to precisely locate the electrodes position.

Diagnostic test

OFS-947S has a built-in diagnostic test function that allows the user to evaluate several critical variable parameters with only one simple step. Perform this function in case of splicer operation fault.

Operation procedure

- 1) Select [Diagnostic Test] in [Maintenance Menu].



2) Execute [Diagnostic test], then the following checks will be made.

Parameter	Description
LED Calibration	Measure and adjust the brightness of LED.
Dust Check	Check the optical path for dust or dirt and judges whether they disturb fiber observation. If contamination exists, press the return button twice to display the location.
Motor Calibration	Automatically calibrate the speed of 4 motors
Arc Calibration	Automatically calibrate the arc power factor and fiber splicing position

Dust check

Through image acquisition, the splicer detects dust and contaminants on the splicer, camera, and objective lenses that may result in improper splicing. This function checks the optical path for the presence or absence of contaminants, and judges whether they will affect the quality of fiber splicing.

Operation procedure

- 1) Select [Dust check] in [Maintenance menu].
- 2) If fibers are set in the splicer, remove them and press [SET] again to start the dust check.
- 3) If dust is detected during the dust check process, the message “Find Dust On The Lens” will be displayed on screen. Press the return button twice, and the location of contamination will be shown on the screen. Then clean the objective lenses, and [Dust check] until the message “Operation Complete” is shown on screen.

Note: If contamination still exists after cleaning the objective lenses, please contact your nearest sales agency.

Motor calibration

Motors are adjusted at the factory before shipping. However, settings may be changed in various reasons. This function automatically calibrates the speed of 6 motors.

Operation procedure

- 1) Select [Motor Calibration] in [Maintenance Menu].
- 2) Load prepared fibers in the splicer, and press [SET].
- 3) Speeds for all motors are automatically calibrated. Upon completion, the message “Operation Complete” will be displayed.

Note: Perform this function when “Fat” or “Thin” error occurs, or fiber aligning or focusing takes too much time.

Arc calibration

Atmospheric conditions such as temperature, humidity and pressure are constantly changing, which creates variability in the arc temperature. OFS-947S is equipped with temperature and pressure sensors that are used in a constant feedback monitoring control system to maintain the arc power at a stable level. However, changes in arc power due to electrode wear and glass adhesion cannot be calibrated automatically. Also, the center position of arc discharge sometimes shifts to the left or to the right. In this case, the fiber splicing position has to be shifted in relation to the arc discharge center. It is necessary to perform an arc power calibration to eliminate those problems.

Note: Performing arc calibration function changes the parameter of the system. The arc power value will not be changed in the splice modes.

Operation procedure

- 1) Select [Arc Calibration] in [Maintenance Menu] to display arc calibration on the screen.
- 2) Place prepared fibers into the splicer, and press [SET] to perform arc calibration.

Note: Use standard SM fiber for arc calibration. Use well-prepared fibers for arc calibration since dust on the fiber surface affects arc calibration.

- 3) The splicer will show up two values on the screen after each arc calibration. If the value shown on the right-hand side meets 11 ± 2 , the message “Operation Complete” will be shown on screen. Otherwise, set prepared fibers on the splicer again and redo arc calibration until the message “Operation Complete” is displayed.

Electrode setting

Set the electrode change warnings. PRO recommends replacing the electrodes every 1500 discharge to ensure the best splice results.

- 1) Select [Electrode Setting] in [Maintenance Menu].
- 2) Set the electrode caution and electrode warning.

Parameter	Description
Electrode Caution	If actual arc discharge exceeds the set value, a message “Caution! Replace Electrodes” is displayed when turning on the splicer. Precision Rated Optics recommends that this parameter should be set to “3500”.
Electrode Warning	If actual arc discharge exceeds the set value, a message “Warning! Replace Electrodes” is displayed when turning on the splicer. Precision Rated Optics recommends that this parameter should be set to “5000”.

Update software

- 1) Select [Update Software] in [System Setting].
- 2) Connect the USB driver with the copy of upgrade files to the micro HDMI port.
- 3) Press “OK”, and then the splicer will process the update automatically. Upon completion, the splicer will restart automatically.

8. Other Functions & Utilities

Data storage

This splicer stores up to 2000 splicing results. Contents of data stored are different depending on the splicing mode.

Display splice record

Splicing results stored in the splicer can be displayed.

- Select [Display Splice Record] in [Data Storage] menu.

Delete splice record

Splicing results can be cleared by part or whole.

- 1) Select [Delete Splice Record], and input specific number (Start Splice Record and End Splicer Record) of splicing results to be cleared.
- 2) Select [Reset Splice Record], then the splicing results will be cleared.

Cancel data storage

If users do not want to save any splicing results, please select [ON] in [Cancel Data Storage].

Parameter	Description
Buzzer	Set On/Off of the buzzer
Temperature Unit	Set the unit of temperature
Automatic Heating	If “Automatic heating” is set to “ON”, heat oven will perform heating automatically when the fiber is put into the heat oven
Language	Select a language to be displayed on the screen
Monitor Position	Set the operational direction of splicer. [Front] is for monitor forward operation. [Rear] is for monitor backward operation. Refer to next page for details
Power Save Option	Set requested time for [Monitor Shut Down] and [Splicer Shut Down].
Set Calendar	Set the system time
Password	Set the password to access some specific menu such as [Power On Option] and [Password Lock]. At the time of shipment from the factory, the password is set to be “0”. If you have forgotten your password which you have set, please contact the sales agency

Monitor Position

The direction of the splicer display before shipping from the factory is set to “Front”, but users can change it to “Rear”. When [Monitor position] is changed, the direction of the arrow keys is reversed.

Changing monitor position

- 1) Select [Monitor Position] in [System Setting] menu.
- 2) Select the desired monitor position (front/rear).

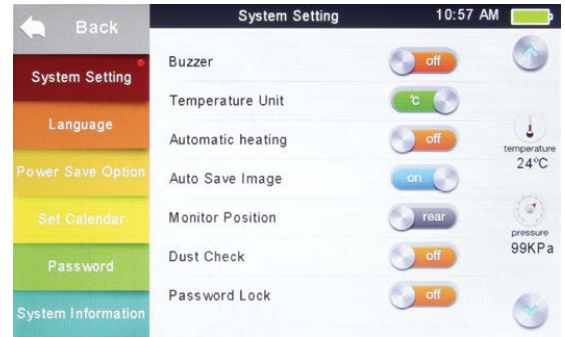
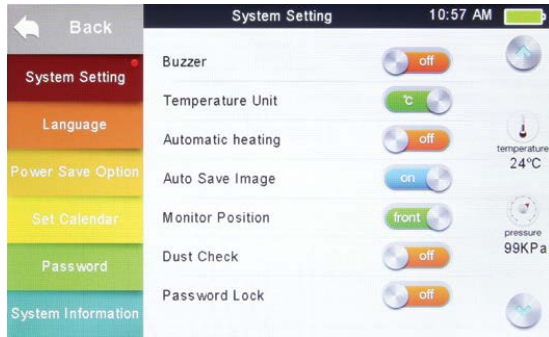

Note: Press ◀ or ▶ buttons to swift the monitor position quickly on Workbench.

Power save option

This function is important for power conservation. If the power saving function is not set during battery use, the number of splice cycles will be reduced.

- 1) Insert a power unit, and turn on the splicer.
- 2) Select [Power Save Option] in [System Setting] menu.
- 3) Change values of [Monitor Shut Down] and [Splicer Shut Down].

Parameter	Description
Monitor Shut Down	Setting this function will automatically turn off the power supply to the LCD monitor if the splicer does not operate after a certain period of time to prevent excessive power loss. When the power supply for LCD monitor turns off, the LED near © key blinks. Press any keys to turn on the LCD monitor.
Splicer Shut Down	Setting this function will automatically turn off the power supply to the splicer if the splicer does not operate after a certain period of time to prevent excessive power loss.







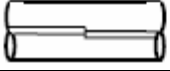

System information

Select [System Information]. The following information is displayed.

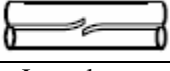
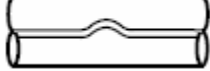
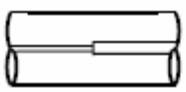
Parameter	Description
Machine Serial Number	Display the serial number of the splicer
Software Version	Display the version of the software
FPGA	Display the version of FPGA
Total Arc Count	Display the total number of arc discharges
Current Arc Count	Display the number of arc discharges after electrode replacement. Performing [Replace Electrode] resets this parameter to zero.
Last Maintenance	Display the date of last maintenance
Production Date	Display the date of production

Appendix I

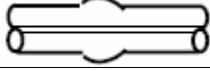
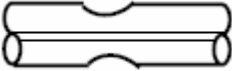
High splice loss solutions

Symptoms	Cause	Corrective measures
Core axis deviation 	Dust on the Ribbon Groove or holder	Clean the Ribbon Groove or holder
Core angle 	Dust on the Ribbon Groove or holder	Clean the Ribbon Groove or holder
	Bad condition of fiber's tip	Check the performance of fiber cutter.
Core deformation 	Dust on the Ribbon Groove or holder	Clean the Ribbon Groove or holder
Irregular core 	Bad condition of fiber's tip	Check the performance of fiber cutter.
	Too low initial discharge or too short initial discharge time	Increase the initial discharge or initial discharge time
Inconsistent MFD 	Too low discharge	Too low discharge
Burned 	Bad condition of fiber's tip	Check the performance of fiber cutter.
	There is still dust after cleaning or discharge for cleaning	Clean the fiber carefully or increase the discharge duration for cleaning.
Bubbles 	Bad condition of fiber's tip	Check the performance of fiber cutter.
	Too low initial discharge or too short initial discharge time	Increase the initial discharge or initial discharge time
Separation 	Too much initial discharge or too long initial discharge time	Increase the duplicated area
		Decrease the initial discharge or initial discharge time
Thick 	Fiber is too long.	Decrease the duplicated area.
Thin 	Incorrect discharge amount	Conduct discharge calibration
	Some discharge elements are not correct	Adjust initial discharge, time and duplicated area.
Line 	Some discharge not correct	Adjust initial discharge, time and duplicated area.

Note: A vertical line sometimes appears at the splice point when MM fibers or dissimilar fibers (different diameters) are spliced. We call it as “Splicing line”. This does not affect splice quality (such as splice loss and tensile strength).

Appendix II

List of error messages

During the splice operating process, if the error messages are shown on the screen, please follow the solution precisely as shown in the list below. If it is not possible to solve the problem, the splicer may require service by a qualified service center. In this case, please contact sales agents.

Error Message	Reason	Solution
Left Fiber Place Error	The fiber end face is placed beyond the electrode centerline	Press RESET button, and reload the fibers to make sure that fiber end face is placed between V-groove and the centerline of electrodes.
Right Fiber Place Error		
Press Motor Distance Over Limit	The fiber is not set correctly at the bottom of the V-groove, which results in that the fiber offsets beyond motor formation range.	Press RESET button, and reposition the fiber at the bottom of the V-groove
Press Motor Error	The motor might be damaged	Consult your nearest sales agent
Search Fiber Endface Failed	The fiber is not set correctly at the bottom of the V-groove	Press RESET button, and reposition the fiber at the bottom of the V-groove
Arc Failure	Arc discharge does not occur	Confirm the electrodes in the proper position; replace electrodes.
Align Motor Distance Over Limit	The fiber is not set correctly at the bottom of the V-groove	Press RESET button, and reposition the fiber at the bottom of the V-groove
Search Fiber Clad Failed	The fiber is not set correctly at the bottom of the V-groove	Press RESET button, and reposition the fiber at the bottom of the V-groove.
Fiber Border Position Wrong	Dust on the fiber surface	Re-prepare the fiber; clean the lens; redo [Dust Check].
Unknown Fiber Type	Dust on the fiber surface.	Re-prepare the fiber
	Different fiber types on two sides	AUTO mode is not applicable in this case; select a suitable splice mode to redo splicing.
	The fiber is a non-standard fiber	AUTO mode can only detect standard SM, MM, NZ fibers
Fiber Clad Over Limit	Fiber edge is not located in the camera range	Adjust the fiber position; perform [Motor Calibration].
Fiber Endface Gap Wrong	[Overlap] is too much	Adjust [Overlap] parameter
	Motor is not calibrated	Perform [Motor calibration]
Fibers Mismatch, Continue?	Different fiber types on two sides	It may result in large splice loss if you continue to splice. Please use the proper splice mode corresponding to the fibers.

Cleave Angle Over Limit	Bad fiber end face	Check the condition of the fiber cleaver. If the blade is worn, rotate the blade to a new position or change a new one, and then re-prepare the fibers.
	[Cleave Angle Limit] is set too low.	Increase the [Cleave Angle Limit] to an adequate limit (standard: 3.0°).
Core Angle Over Limit	[Core Angle Limit] is set too low	Increase the [Core Angle Limit] to an adequate limit (standard: 1.0°).
	Dust or dirt on the V-groove or fiber holders.	Clean the V-groove and fiber holders. Prepare the fibers and re-load them.
Fiber Axis Align Failed	Too large axial offset (>4.0μm).	Re-prepare the fibers
	The motor is not calibrated	Perform [Motor calibration].
Fiber is Dirty	Dust or dirt on the fiber surface	Prepare the fiber again
	The lenses are covered with dust	Perform [Dust check] after cleaning the lenses
	[Clean Arc Time] is too short	Set [Clean Arc Time] to 180ms
	It is difficult to identify the fiber core by using the method of core alignment to splice.	Use MM splice mode (clad alignment) to splice the unidentified fiber core.
Fat Splicing Point	[Overlap] is too much	Adjust [Overlap] parameter
	The motor is not calibrated	Perform [Motor Calibration].
Thin Splicing Point	Arc power is too low	Perform [Arc Calibration].
	The level of pre-discharge is too high.	Decrease pre-discharge or pre-discharge time.
	Insufficient [Overlap].	Adjust [Overlap] parameter

Appendix III

Frequent questions and troubleshooting

Note: The solutions of common faults for reference are as follows. Please contact sales agents for further support if needed.

Power does not turn off when pressing ON/OFF button.

- Press and hold the key until the LED blinks, and then release the button to turn off the splicer.

Few splices can be made with a fully charged battery pack.

- Enable the power save option.
- If degradation appears or the battery pack is stored for an extended period of time, completely discharge it. And recharge the battery pack.
- The battery pack has reached the end of its battery life. Change a new battery pack.
- The capacity decreases at excessive low temperature.

Error message appears on monitor.

- Please refer to Appendix II.

High splice loss.

- Clean the V-groove and fiber holders.
- Replace the electrodes.
- Please refer to Appendix I.
- The splice loss varies according to the cleave angle, arc conditions and fiber cleanliness.

Monitor suddenly turns off.

- If the power save option is enabled, the monitor will turn off after an extended period of splicer inactivity. Press any key to return to the normal state.

Splicer suddenly turns off.

- If the power save option is enabled, the splicer will turn off after an extended period of splicer inactivity.

Identify fiber error in AUTO mode.

- AUTO mode is only applicable for SM, MM, NZ fibers. AUTO mode may not be able to identify while splicing special fibers.

Mismatch between estimated splice loss and actual splice loss.

- The estimated loss is just an estimated number by calculation, for reference only.
- The optical components of the splicer need to be cleaned.

Fiber protection sleeve does not shrink completely.

- Extend the heating time.

Method to cancel heating process.

- Press HEAT button to stop during heating process. The LED light will go off after pressing the key.

Fiber protection sleeve sticks to heating plate after shrinking.

- Use a cotton swab or a similar soft tip object to push and remove the sleeve.

Forgot password.

- Please contact the sales agent.

No arc power change after [Arc Calibration].

- It is the internal parameters that are calibrated and adjusted after arc calibration. The displayed arc power in each splice mode does not change.

Forgot to load fibers while execute some specific maintenance function that fibers are needed.

- Return key is invalid in this case. Open the windproof cover, load prepared fibers in the splicer, and press [SET] to continue or press [RESET].

Upgrading failure.

- When users use the new USB to upgrade, the splicer may not be able to identify the upgrade file correctly. In this case, please re-plug the USB and restart the splicer.
- Check if the upgrade file name and the format are correct.
- Please contact sales agent if you still cannot solve the problem.

Other

- Please refer to the video in the user CD.

Note: Product model and specifications are subject to change without prior notice.



Precision Rated Optics, Inc.

Corporate Office

Billing & Processing

PO Box 877 Trexlertown, PA 18087

Precision Rated Optics, Inc.

Product Distribution Center Manufacturing & Testing

9999 Hamilton Blvd Breinigsville, PA 18031